

Pompe acqua, Water pumps, Wasserpumpen, Pompes à eau,  
Bombas de agua, Bombas de água, Αντλίες νερού,  
Pompy wody, Водяные насосы, Su pompalari



*Indice*  
*Contents*  
*Inhaltsverzeichnis*  
*Sommaire*  
*Índice*  
*Índice*  
*Περιεχόμενα*  
*Spis treści*  
*Содержание*  
*Índeks*

Indice costruttori  
 Manufacturers index  
 Herstellerverzeichnis  
 Sommaire par marques  
 Índice constructores  
 Índice de montadoras  
 Ευρετήριο κατασκευαστών  
 Indeks producentów  
 Индекс изготовителей  
 Üreticiler

3

Legenda  
 Legend  
 Legende  
 Légende  
 Leyenda  
 Legenda  
 Υπόμνημα  
 Legenda  
 Легенда  
 Semboller

6

Applicazione per marca e veicolo  
 Vehicle application guide  
 Zuordnung nach Marke und Fahrzeug  
 Affectations par marques et véhicules  
 Aplicación por marca y vehículo  
 Aplicação por marca e veículo  
 Εφαρμογή ανά μοντέλο  
 Zastosowanie dla marki i pojazdu  
 Применение по марке и модели  
 Marka ve araca göre uygulama

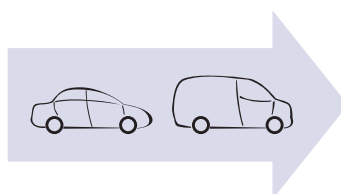

13

Applicazione per codice  
Buyers guide  
Zuordnung nach Bestellnummer  
Affectations par références  
Aplicación por referencia  
Aplicação por código  
Εφαρμογές ανά κωδικό  
Zastosowanie dla kodu  
Применение по коду  
Koda göre uygulama

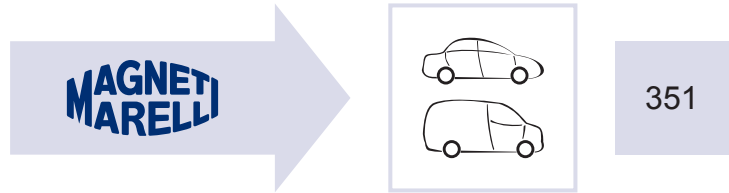

Tavole di comparazione OES  
OES cross reference guide  
Gegenüberstellung OES  
Table de correspondance OES  
Tabla de equivalencias OES  
Tabela de equivalências OES  
Πίνακας αντιστοιχιών OES  
Tabela porównawcza OES  
Кросс-таблица с OES номерами  
OES karşılaştırma referans tablosu



Tavole di comparazione IAM  
IAM cross reference guide  
Gegenüberstellung IAM  
Table de correspondance IAM  
Tabla de equivalencias IAM  
Tabela de equivalências IAM  
Πίνακας αντιστοιχιών IAM  
Tabela porównawcza IAM  
Кросс-таблица с IAM номерами  
IAM karşılaştırma referans tablosu



*Indice costruttori*  
*Manufacturers index*  
*Herstellerverzeichnis*  
*Sommaire par marques*  
*Índice constructores*  
*Índice de montadoras*  
*Ευρετήριο κατασκευαστών*  
*Indeks producentów*  
*Индекс изготовителей*  
*Üreticiler*

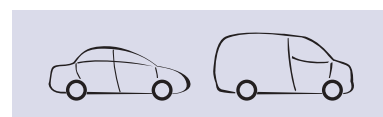

ABARTH .....	15
ACURA .....	15
ALFA ROMEO .....	15
AUDI .....	22
AUSTIN .....	45
AUTOBIANCHI .....	45
BMW .....	45
CADILLAC .....	59
CHEVROLET .....	60
CHRYSLER .....	62
CITROËN .....	63
DACIA .....	85
DAEWOO .....	88
DAIHATSU .....	90
DODGE .....	92
DS .....	92
FIAT .....	93
FORD .....	117
HONDA .....	136



HYUNDAI .....	139
INFINITI.....	145
INNOCENTI.....	145
IVECO .....	146
JAGUAR.....	148
JEEP.....	148
KIA.....	149
LADA .....	152
LANCIA.....	154
LAND ROVER .....	159
LEXUS.....	160
LOTUS.....	160
MAZDA.....	160
MEGA.....	163
MERCEDES-BENZ .....	163
MG.....	183
MINI .....	184
MITSUBISHI.....	186
NISSAN .....	189
OPEL .....	195
PEUGEOT .....	214
PROTON .....	235
PUCH .....	235
RENAULT .....	236
ROVER.....	267
SAAB .....	270
SEAT .....	272
SKODA.....	284



SMART .....	289
SSANGYONG .....	290
SUBARU.....	291
SUZUKI .....	291
TOYOTA .....	295
VAUXHALL .....	302
VOLKSWAGEN .....	303
VOLVO .....	336
ZASTAVA.....	349

*Legenda*  
*Legend*  
*Legende*  
*Légende*  
*Leyenda*  
*Legenda*  
*Υπόμνημα*  
*Legenda*  
*Легенда*  
*Semboller*

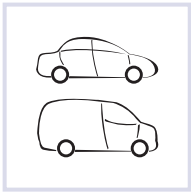

Costruttore e modello  
Make and model  
Hersteller und Modell  
Marque et modèle  
Constructor y modelo  
Montadora e modelo  
Μάρκα και μοντέλο  
Marka i model  
Производитель и модель  
Üretici ve model

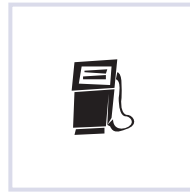

Tipo di carburante  
Type of fuel  
Karftstoffart  
Type de carburant  
Tipo de gasolina  
Tipo de combustível  
Τύπος Καυσίμου  
Typ paliwa  
Вид топлива  
Yakıt tipi



Anno di produzione  
Manufacturing year  
Baujahr  
Année de production  
Año de fabricación  
Ano de fabricação  
Ετος παραγωγής  
Rok produkcji  
Год производства  
Üretim yılı

**B** Benzina  
Petrol  
**BF** Bi-Fuel  
Bi-Fuel  
**D** Diesel  
Diesel  
**FF** Flex-Fuel  
Flex Fuel  
**G** Gas  
Gas  
**M** Metano  
Methane



Numero cilindri  
Number of cylinders  
Anzahl der Zylinder  
Nombre de cylindres  
Numero de cilindros  
Número de cilindros  
Αριθμός κυλίνδρων  
Liczba cylindrów  
Количество цилиндров  
Silindir Sayısı

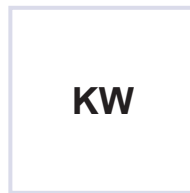

Potenza kW  
Output kW  
Leistung kW  
Puissance kW  
Potencia kW  
Potência kW  
Απόδοση kW  
Мощ kW  
Мощность кВт  
Güç kW



**cm<sup>3</sup>**

Cilindrata cm<sup>3</sup>  
Capacity cm<sup>3</sup>  
Hubraum cm<sup>3</sup>  
Cylindrée en cm<sup>3</sup>  
Cilindrada cm<sup>3</sup>  
Cilindrada cm<sup>3</sup>  
Χωριτικότητα cm<sup>3</sup>  
Pojemność w cm<sup>3</sup>  
Объем (cm<sup>3</sup>)  
Карасите cm<sup>3</sup>

Codici Magneti Marelli  
Magneti Marelli references  
Magneti Marelli Nr.  
Références Magneti Marelli  
Códigos Magneti Marelli  
Códigos Magneti Marelli  
Κωδικοί Magneti Marelli  
Kody Magneti Marelli  
Коды Магнети Марелли  
Magneti Marelli kodları



Tipo di cambio  
Type of gear  
Art des schaltgetriebes  
Type de boîte de vitesse  
Tipo de cambio  
Tipo de caixa de velocidades  
Τύπος ταχυτήτων  
Typ skrzyni biegów  
Тип коробки передач  
Vites tipi



Informazioni tecniche  
Technical information  
Technische Informationen  
Informations techniques  
Información técnica  
Informações técnicas  
Τεχνικές πληροφορίες  
Informacje techniczne  
Техническая информация  
Teknik bilgiler

**A** Cambio automatico - Automatic transmission -  
Automatik-Getriebe - Boîte automatique - Cambio  
automático - Caixa automática - Αυτόματο  
κιβώτιο - Automatische skrzynia biegów -  
Автоматическая Коробка Передач - Vites için  
ECU

**M** Cambio manuale - Manual transmission -  
Handschaltung - Changement de vitesses  
manuel - Cambio manual - Caixa manual -  
Χειροκίνητο κιβώτιο - Ręczna skrzynia biegów -  
Механическая коробка передач - Manual vites

**OES/IAM**

Codice costruttore  
IAM/OES Reference  
Herstellernummer  
Référence Origine (IAM/OES)  
Código constructor  
Código de montadora  
Κωδικός κατασκευαστή  
Kod IAM/OES  
Оригинальные номера  
Üretici kodu

**NO. OF  
VALVES**

N. valvole  
No. of valves  
Anzahl Ventile  
Nombre de soupapes  
N° válvulas  
N° de válvulas  
Αριθμος βαλβιδων  
Liczba zaworów  
Количество лопастей  
Valf sayisi

**(+)AC**

Con aria condizionata  
Air Conditioning Unit  
Klimaanlage  
Avec air conditionné  
Aire Acondicionado  
Ar condicionado  
με A/C  
Z klimatyzacją  
С кондиционер  
Klima ünitesi

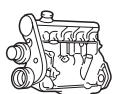

Codice motore  
Engine code  
Motor code  
Code moteur  
Código motor  
Código motor  
Κωδικός κινητήρα  
Kod silnika  
Номер двигателя  
Motor numarasi

**(-)AC**

Senza aria condizionata  
Without air conditioning  
Ohne Klimaanlage  
Sans air conditionné  
Sin Aire Acondicionado  
Sem ar condicionado  
Χωρίς A/C  
Bez klimatyzacji  
Без Кондиционера  
Klimasız

<b>(+)COP</b>	Con coperchio With backhousing Mit Anbaugehäuse Avec carter arriere Con tapa Sim tapa Με καπάκι Z pokrywka С крышкой Karaklı	<b>(+)SS</b>	Con servosterzo Power steering Servolenkung Direction assistée Dirección asistida Direção hidráulica Ηλεκτρική υποβοήθηση Ze wspomaganiem kierownicy С гидроусилителем Servo direksiyonlu
<b>(-)COP</b>	Senza coperchio Without backhousing Ohne Anbaugehäuse Sans carter arriere Sin tapa Sem tapa Χωρίς κάλυμμα Bez pokrywy Без покрытия Karaksız	<b>(-)SS</b>	Senza servosterzo W/O Power steering Ohne Servolenkung Sans Direction assistée Sin Dirección asistida Sem direção hidráulica χωρίς Ηλεκτρική υποβοήθηση Bez wspomagania kierownicy Без гидроусилителя Servo direksiyonsuz
<b>M</b>	Motore n° Engine No. Motor nr. Moteur n. Motor n. N.° motor Κινητήρας N° Silnik N° Двигатель N° Motor N°	<b>T</b>	Telaio n° Chassis no. Fahrgestell-Nr. Chassis n. Bastidor n. Número do chassi Αριθμός πλαισίου Nr podwozia Номер шасси Şasi nr.
<b>MAT AL</b>	Alluminio Aluminium Aluminium Aluminium Alumínio Αλουμίνιο Aluminium Алюминий Alüminyum	<b>VA</b>	Ventilatore automatico Automatic ventilator Automatischer Ventilator Ventilateur automatique Ventilador automático Ventilador automático Αυτόματο ανεμιστήρα Automatyczny wentylator Автоматический вентилятор Otomatik fan
<b>MAT Gh</b>	Ghisa Cast iron Roheisen Fonte Arrabio Fundido Χυτοσίδηρος Želiwo Чугун Demir parçası	<b>VF</b>	Ventilatore fisso Fixed ventilator Fixierter Ventilator Ventilateur fixe Ventilador fijo Controle do ventilador Σταθερό ανεμιστήρα Stała wentylatora Фиксированный вентилятор Sabit fan

<b>ALBERINO</b>	Alberino Shaft Arbre Spindel Eje Eixo Wał Αξονας Вал	<b>Diametro Mozzo</b>	Diametro mozzo Hub diameter Diamètre moyeu Nabe Durchmesser Diámetro del cubo Diâmetro do cubo Średnica piasty Διάμετρος πλήμνης Диаметр сальника
<b>Altezza Puleggia</b>	Altezza puleggia Pulley height Hauteur poulie Riemenscheibe Höhe Altura polea Altura da polia Wysokość koła pasowego Υψος τροχαλίας Высота шкива	<b>Diametro Puleggia</b>	Diametro puleggia Pulley diameter Diamètre poulie Riemenscheibe Durchmesser Diámetro de la polea Diâmetro da polia Średnica koła pasowego Διάμετρος τροχαλίας Диаметр шкива
<b>Diametro Alberino</b>	Diametro alberino Shaft diameter Diamètre arbre Spindel Durchmesser Diámetro del eje Diâmetro do eixo Średnica wału Διάμετρος άξονα Диаметр вала	<b>Dimensione Fori Flangia</b>	Dimensione fori flangia Flange holes dimension Dimension de trous flasque Masse der Flanschloecher Dimensiones de los agujeros de brida Dimensões dos orifícios de flange Wymiary otworów w kołnierzu Μέγεθος τρυπών φλάντζας Размер отверстий фланца
<b>Diametro Centraggio</b>	Diametro centraggio Centering diameter Diamètre de centrage Zentrierung Durchmesser Diámetro de centrado Diâmetro de centralização Średnica otworu centrującego Κεντράρισμα διαμέτρου Диаметр центрирования	<b>FLANGIA</b>	Flangia Flange Moyeu Flansch Brida Mesa Kołnierz Φλαντζα Фланец
<b>Diametro Girante</b>	Diametro girante Impeller diameter Diamètre turbine Flügelrad Durchmesser Diámetro del impulsor Diâmetro do impulsor Średnica wirnika Διάμετρος φτερωτής Диаметр крыльчатки	<b>N° Alette Girante</b>	N° alette girante No. Impeller fins Nombre d' ailettes Nummer der Flügelradfluegel N° aletas impulsor Número aletas do impulsor Ilość łopatek w wirniku Αρ. Πτερυγίων φτερωτής Количество лопастей крыльчатки

<b>Numero Denti/ Gole Puleggia</b>	Numero denti/gole puleggia No. pulley teeth/throats No. de dents/gorges poulie Nummer der Zaehne der Riemenscheibe Nº dientes polea Número dentes/gargantas da polia Ilość zębów w kole pasowym Αριθμός δοντιών/αυλακώσεων Число зубцов	<b>Posizione Girante</b>	Posizione girante Impeller position Position de turbine Einsatzstelle des Flügelrad Posición del impulsor Impulsor posição Położenie wirnika Θέση φτερωτής Расположение крыльчатки
<b>Numero Fori Flangia</b>	Numero fori flangia No. flange holes No. de trous flasque Nummer der Flanschloecher Nº agujeros de brida Número flange holes Ilość otworów w kołnierzu Αριθμός τρυπών φλάντζας Количество отверстий	<b>PULEGGIA</b>	Puleggia Pulley Poulie Riemenscheibe Polea Polia Kolo pasowe Τροχαλία Шкив
<b>Posizione Attacco</b>	Posizione attacco Fixing position Position de fixation Kupplungsbolzen Posición de fijación Fixação posição Miejsce mocowania Θέση επισκευής Место фиксации	<b>Tipo Filetto Alberino</b>	Tipo filetto alberino Shaft thread type Type de filetage arbre Typ der Gewinde im Spindel Tipo de rosca del eje Tipo de rosca do eixo Rodzaj gwintu Τύπος φθοράς άξονα Тип резьбы

Magneti Marelli After Market Parts and Services S.p.A. ha curato con particolare attenzione la stesura del presente catalogo; declina comunque ogni responsabilità per eventuali errori od omissioni relativi a schemi, disegni, immagini, corrispondenze con i codici O.E. ecc. e si riserva il diritto di apportare modifiche al contenuto senza l'obbligo di darne preventiva comunicazione. Sono particolarmente graditi, da parte degli utenti, commenti, segnalazioni di inesattezze e qualsiasi altro suggerimento atto a rendere più efficace la prossima edizione del catalogo.

Magneti Marelli After Market Parts and Services S.p.A. has devoted its best attention to the editing of this catalogue; it nevertheless declines any responsibility for possible mistakes or omissions regarding figures, drawings, pictures, correspondence with O.E. codes etc. and it reserves the right to modify the contents without prior notice. Users' comments, reports of inaccuracies or any other suggestions which may in any way improve the next edition of this catalogue are warmly welcomed.

Magneti Marelli After Market Parts and Services S.p.A. hat diesen Katalog sorgfältig verfasst. Die Firma enthebt sich jeglicher Verantwortung für eventuelle Fehler oder Auslassungen hinsichtlich Schemen, Darstellungen, Bilder, Zeichnungen, Übereinstimmungen, mit O.E. Codes usw. und behält sich das Recht vor, ohne Ankündigung, am Inhalt Veränderungen vorzunehmen. Anmerkungen, Fehlerhinweise und weitere Anregungen seitens der Kunden werden gerne entgegengenommen, um die nächste Ausgabe des Katalogs effizienter zu gestalten.

Magneti Marelli After Market Parts and Services S.p.A. a soigné avec une attention particulière la rédaction de ce catalogue; elle décline cependant toute responsabilité pour toute erreur ou omission éventuelle dans les schémas, les dessins, les images, les correspondances avec les codes O.E., etc. et se réserve le droit d'en modifier le contenu sans obligation de communication préalable. Les commentaires, les signalisations d'inexactitudes et toute autre suggestion des utilisateurs susceptibles de rendre la prochaine rédaction du catalogue plus efficace seront particulièrement appréciés.

Magneti Marelli After Market Parts and Services S.p.A. ha cuidado con especial atención la redacción del presente catálogo; de todas maneras declina toda responsabilidad por eventuales errores u omisiones relativos a esquemas, diseños, fotos, correspondencia con los códigos O.E., etc., y se reserva el derecho de aportar modificaciones al contenido sin la obligación de previo aviso. Se agradecen especialmente los comentarios, las indicaciones al contenido sin la obligación de previo aviso. Se agradecen especialmente los comentarios, las indicaciones de inexactitudes y cualquier otra sugerencia por parte de los usuarios que sean útiles para hacer más eficaz la próxima edición del catálogo.

A Magneti Marelli After Market Parts and Services S.p.A. cuidou com particular atenção a redação do presente catálogo; como quer que seja, rejeita qualquer responsabilidade face a eventuais erros o omissões relacionados aos esquemas, desenhos, imagens, correspondências aos códigos O.E. etc. e reserva-se o direito de introduzir alterações ao seu conteúdo sem a obrigação de comunicação prévia das mesmas. São particularmente bem aceitos, comentários, sinalizações de inexatidões e qualquer outra sugestão idónea a tornar mais eficaz a próxima edição do catálogo.

Η Magneti Marelli φροντίσε με κάθε λεπτομερεια την ορθότητα των στοιχειων αυτου του καταλογου, δεν φερει ομως καμια ευθυνη για τυχον λαθη ή παραληψεις που σχετιζονται με σχηματα, σχεδια, εικόνες, αντι-στοιχίες με γνησια νομμερα κτλ. και επιφυλασσειται του δικαιωματος να αλλαξει το περιεχομενο του καταλογου οποιαδηποτε στιγμή χωρις προτερη ενημερωση. Οποιαδηποτε σχολια η παρατηρησεις, με στοχο την βελτιωση του καταλογου, ειναι ευπροσδεκτα.

Firma Magneti Marelli After Market Parts and Services S.p.A. dołożyła szczególnych starań przy opracowywaniu niniejszego katalogu. Nie ponosi ona jednak żadnej odpowiedzialności za ewentualne błędy lub braki dotyczące schematów, rysunków, zgodności z kodami O.E., itp. u. Firma Magneti Marelli After Market Parts and Services S.p.A. zastrzega sobie prawo do wprowadzania zmian bez obowiązku uprzedniego powiadomienia o tym. Szczególnie mile widziane są komentarze i sygnały dotyczące nieprawidłowości oraz jakiegokolwiek inne sugestie zgłaszane przez klientów, mające na celu udoskonalenie następných edycji katalogu.

Magneti Marelli After Market Parts and Services S.p.A. уделила особое внимание созданию этого каталога. Но, несмотря на это, мы не несем ответственности за возможные ошибки или неточности в цифрах, изображениях или кросс-номерах. Также мы оставляем за собой право вносить любые изменения в содержание каталога без предварительного уведомления. Мы приветствуем любые ваши замечания и комментарии, которые обязательно учтем при подготовке следующих выпусков каталога.

Magneti Marelli After Market Parts and Services S.p.A bu katalogdaki bilgileri çok dikkatli bir şekilde hazırlamış olup, buna rağmen rakam, çizim, resim, OE kodları ve diğer tüm bilgilerdeki hata ya da eksikliklerin sorumluluğunu kabul etmez ve ön bilgi vermeden değişiklik yapma hakkını saklı tutar. Bir sonraki katalogun iyileştirilmesine yardımcı olacak kullanıcı yorumları, hata raporları, ya da diğer öneriler değerlendirmeye alınacaktır.

---

È vietata la riproduzione, anche parziale, del contenuto del presente catalogo senza preventiva autorizzazione scritta della Magneti Marelli After Market Parts and Services S.p.A, che tutelerà i propri diritti a termine di legge.

It is forbidden to reproduce, even partially, the contents of this catalogue without prior written consent from Magneti Marelli After Market Parts and Services S.p.A., who will protect its rights in accordance with the law.

Die Vervielfältigung, auch teilweise, des urheberrechtlich geschützten Inhalts des vorliegenden Katalogs ist ohne schriftliche Genehmigung durch Magneti Marelli After Market Parts and Services S.p.A. untersagt.

Il est interdit de reproduire même partiellement le contenu de ce catalogue sans autorisation écrite préalable de Magneti Marelli After Market Parts and Services S.p.A., qui protégera ses droits selon les termes de la loi.

Está prohibida la reproducción, total o parcial, del contenido del presente catálogo sin previa autorización escrita de Magneti Marelli After Market Parts and Services S.p.A, que protegerá sus propios derechos con arreglo a la ley.

É proibida a reprodução, também parcial, do conteúdo do presente catálogo sem a prévia autorização escrita de Magneti Marelli After Market Parts and Services S.p.A, que defenderá os próprios direitos, nos termos de lei.

Απαγορεύεται η αναπαραγωγή, ολική ή μερική, του περιεχομένου του παρόντος καταλόγου χωρίς την γραπτή εξουσιοδότηση της Magneti Marelli After Market Parts and Services S.p.A.

Zabroniona jest nawet częściowa reprodukcja zawartości katalogu bez uprzedniej pisemnej autoryzacji ze strony firmy Magneti Marelli After Market Parts and Services S.p.A., która chroni swą własność zgodnie z przepisami prawa.

Запрещается полная или частичная перепечатка содержания каталога без предварительного письменного разрешения Magneti Marelli After Market Parts and Services S.p.A. Компания будет отстаивать свои интересы в соответствии с законом.

Tüm yasal hakların sahibi olan Magneti Marelli After Market Parts and Services S.p.A. 'in yazılı izni olmaksızın mevcut katalogun kısmen de olsa çoğaltılması yasaktır.

**Applicazione per marca e veicolo**  
**Vehicle application guide**  
**Zuordnung nach Marke und Fahrzeug**  
**Affectations par marques et véhicules**  
**Aplicación por marca y vehículo**  
**Aplicação por marca e veículo**  
**Εφαρμογή ανά μοντέλο**  
**Zastosowanie dla marki i pojazdu**  
**Применение по марке и модели**  
**Marka ve araca göre uygulama**

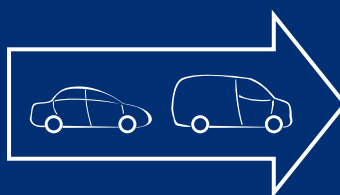





--	--	--	--	--	--	--	--	--	--

## ABARTH

### 500

1.4	99	08/08 →	1.368	B	M	4	16	312A1.000	PIERBURG	81369
	103	05/10 →	1.368	B	M	4	16	312A3.000	TESMA	82070
	118	08/08 →	1.368	B	M	4	16	312A1.000, 312A3.000	TESMA	82070
	132	08/08 →	1.368	B	M	4	16	312A3.000	TESMA	82070
	139	08/08 →	1.368	B	M	4	16	312A1.000, 312A9.000	TESMA	82070

### 500C

1.4	99	01/11 →	1.368	B	M	4	16	312A1.000	TESMA	82070
	103	09/09 →	1.368	B	M	4	16	312A3.000	TESMA	82070
	118	05/11 →	1.368	B	M	4	16	312A1.000, 312A3.000	TESMA	82070
	132	09/09 →	1.368	B	M	4	16	312A3.000	TESMA	82070

### Grande Punto

1.4	114	12/07 → 06/10	1.368	B	M	4	16	199A8.000	PIERBURG	81369
	132	12/07 → 12/12	1.368	B	M	4	16	199A8.000, 955A8.000	PIERBURG	81369

### Punto

1.4	120	10/09 →	1.368	B	M	4	16	955A8.000	TESMA	82070
	132	07/08 →	1.368	B	M	4	16	199A8.000, 955A8.000	TESMA	82070

## ACURA

### CL

2.2	108	10/96 → 09/97	2.156	B	M	4	16	F22B2		81708
2.3 Vtec	112	10/98 → 09/00	2.254	B	M	4	16	F23A7		81708

### Integra III

1.8 LS	125	10/93 → 09/01	1.797	B	M	4	16	F18C1		81839
--------	-----	---------------	-------	---	---	---	----	-------	--	-------

## ALFA ROMEO

### 33 I, Sportwagon

1.5	70	05/83 → 12/93	1.490	B	M	4	8	AR30182		11706T
-----	----	---------------	-------	---	---	---	---	---------	--	--------

### 33 II, Sportwagon

1.4 i.e.	65	06/91 → 09/94	1.351	B	M	4	8	AR30753, AR30755		11706T
	66	06/91 → 09/94	1.351	B	M	4	8	AR30755		11706T
	65	06/91 → 09/94	1.351	B	M	4	8	AR30753, AR30755		11706T
	66	06/91 → 09/94	1.351	B	M	4	8	AR30753, AR30755		11706T
1.5	77	01/90 → 04/93	1.490	B	M	4	8	AR30734		11706T
1.5 i.e.	71	01/90 → 09/94	1.490	B	M	4	8	AR30751		11706T
	74	07/90 → 08/91	1.490	B	M	4	8	AR30750		11706T
1.7 16V	101	01/90 → 03/92	1.712	B	M	4	16	AR30746		11706T
	95	01/90 → 09/94	1.712	B	M	4	16	AR30747		11706T
	97	01/90 → 03/92	1.712	B	M	4	16	AR30747		11706T
	101	01/90 → 03/92	1.712	B	M	4	16	AR30746		11706T
1.7 16V 4x4	95	01/90 → 09/94	1.712	B	M	4	16	AR30747		11706T
	97	01/90 → 09/94	1.712	B	M	4	16	AR30747		11706T
	101	01/90 → 09/94	1.712	B	M	4	16	AR30746		11706T

**KW**

**cm<sup>3</sup>**

**NO. OF VALVES**

**ALFA ROMEO**
**33 II, Sportwagon**

1.7 i.e.	77	04/92 → 09/94	1.712	B	M	4	8	AR30737		11706T
	77	04/92 → 09/94	1.712	B	M	4	8	AR30737A		11706T
	79	01/90 → 09/94	1.712	B	M	4	8	AR30736, AR30737		11706T
1.7 i.e. 4x4	79	01/90 → 03/92	1.712	B	M	4	8	AR30736, AR30737		11706T
	79	01/90 → 03/92	1.712	B	M	4	8	AR30736, AR30737		11706T
1.8 TD	62	07/90 → 09/94	1.779	D	M	3	6	VM96A		81302

**75**

1.6	81	05/89 → 02/92	1.567	B	M	4	8	AR61101		11701T
1.8	95	05/89 → 12/92	1.779	B	M	4	8	AR61202		11701T
	95	08/89 → 02/92	1.773	B	M	4	8	AR67101		11701T
	88	09/88 → 02/92	1.779	B	M	4	8	AR06168, AR61102		11701T
	90	08/89 → 02/92	1.779	B	M	4	8	AR61201		11701T
1.8 Turbo	110	09/86 → 02/92	1.779	B	M	4	8	AR06134		11701T
1.8 Turbo i.e.	114	02/86 → 01/90	1.779	B	M	4	8	AR06134, AR06158		11701T
2.0 T.S	109	05/85 → 02/92	1.962	B	M	4	8	AR06224		11701T
	107	01/87 → 02/92	1.962	B	M	4	8	AR06166, AR06224		11701T
2.5 V6 Cat.	113	09/86 → 05/90	2.492	B	M	6	12	AR01648	BC	11707
3.0 V6	136	01/87 → 02/92	2.959	B	M	6	12	AR06120, AR06124	BC	11707
	141	02/90 → 02/92	2.959	B	M	6	12	AR61503		19532/E

**145**

1.4 i.e.	66	07/94 → 12/96	1.351	B	M	4	8	AR33501	07-1994 →, → 09-1996	11706T
1.4 i.e. 16V T.S.	76	12/96 → 01/01	1.370	B	M	4	16	AR33503, AR38501		81331
1.6 16V T.S.	82	09/97 → 12/00	1.598	B	M	4	16	AR32102		81348
1.6 i.e.	76	10/94 → 12/96	1.596	B	M	4	8	AR33201		11706T
1.6 i.e. 16V T.S.	88	12/96 → 01/01	1.598	B	M	4	16	AR38201, AR67601		81348
1.7 i.e. 16V	95	10/94 → 12/96	1.712	B	M	4	16	AR33401		11706T
1.8 i.e. 16V	106	03/98 → 01/01	1.747	B	M	4	16	AR32201		81331
1.8 i.e. 16V T.S.	103	12/96 → 12/98	1.747	B	M	4	16	AR38401, AR67106, AR67199		81331
1.9 JTD	77	02/99 → 01/01	1.910	D	M	4	8	AR32302		81352
1.9 TD	66	10/94 → 02/99	1.929	D	M	4	8	AR33601, AR67501	(-)COP, 10-1994 →, → 02-1999	81326
	66	10/94 → 02/99	1.929	D	M	4	8	AR33601, AR67501	(-)COP, 10-1996 →, → 02-1999	81363
	66	10/94 → 02/99	1.929	D	M	4	8	AR33601, AR67501	(+)COP, 10-1994 →, → 09-1996	81464
	66	10/94 → 02/99	1.929	D	M	4	8	AR33601, AR67501	(+)COP, 10-1996 →, → 02-1999	81347
2.0 16V Quadrifoglio	114	03/98 → 01/01	1.970	B	M	4	16	AR32301		81331
2.0 16V T.S.	110	10/95 → 01/01	1.970	B	M	4	16	AR67204		81331

		<b>KW</b>		<b>cm<sup>3</sup></b>				<b>NO. OF VALVES</b>			<b>MAGNETI MARELLI</b>
--	--	-----------	--	-----------------------	--	--	--	----------------------	--	--	------------------------

## ALFA ROMEO

### 146

1.4 i.e.	66	12/94 → 12/96	1.351	B	M	4	8	AR33501	05-1995 →, → 09-1996	11706T
1.4 i.e. 16V T.S.	76	11/96 → 01/01	1.370	B	M	4	16	AR33503, AR38501		81331
1.6 16V T.S.	82	09/97 → 12/00	1.598	B	M	4	16	AR32102		81348
1.6 i.e.	76	12/94 → 12/96	1.596	B	M	4	8	AR33201	05-1995 →, → 09-1996	11706T
1.6 i.e. 16V T.S.	88	11/96 → 01/01	1.598	B	M	4	16	AR38201, AR67601		81348
1.7 i.e. 16V	95	12/94 → 12/96	1.712	B	M	4	16	AR33401	05-1995 →, → 09-1996	11706T
1.8 i.e. 16V T.S.	103	11/96 → 01/01	1.747	B	M	4	16	AR38401, AR67106		81331
	106	03/98 → 01/01	1.747	B	M	4	16	AR32201		81331
1.9 JTD	77	02/99 → 01/01	1.910	D	M	4	8	AR32302		81352
1.9 TD	66	12/94 → 02/99	1.929	D	M	4	8	AR33601, AR67501	(-)COP, 10-1995 →	81363
	66	12/94 → 02/99	1.929	D	M	4	8	AR33601, AR67501	(-)COP, 12-1994 →, → 09-1996	81326
	66	12/94 → 02/99	1.929	D	M	4	8	AR33601, AR67501	(+)COP, 10-1996 →, → 02-1999	81347
	66	12/94 → 02/99	1.929	D	M	4	8	AR33601, AR67501	(+)COP, 12-1994 →, → 09-1996	81464
2.0 16V Quadrifoglio	114	03/98 → 01/01	1.970	B	M	4	16	AR32301		81331
2.0 16V T.S.	110	10/95 → 01/01	1.970	B	M	4	16	AR67204	10-1995 →	81331

### 147

1.6 16V T.SPARK	88	01/01 → 03/10	1.598	B	M	4	16	AR32104		81331
1.6 16V T.SPARK ECO	77	01/01 → 03/10	1.598	B	M	4	16	AR37203		81331
1.9 JTD	74	06/03 → 03/10	1.910	D	M	4	8	182B9.000		81352
	81	11/00 → 09/04	1.910	D	M	4	8	AR37101		81352
	85	04/01 → 03/10	1.910	D	M	4	8	937A2.000		81352
1.9 JTD 16V	93	09/03 → 09/04	1.910	D	M	4	16	937A4.000		81872
	100	10/04 → 03/10	1.910	D	M	4	16	192B1.000		81872
	103	11/02 → 03/10	1.910	D	M	4	16	192A5.000		81872
1.9 JTDM	85	10/04 → 03/10	1.910	D	M	4	8	939A7.000		81352
1.9 JTDM 16V	110	09/04 → 03/10	1.910	D	M	4	16	937A5.000		81872
	125	06/08 → 03/10	1.910	D	M	4	16	937A6.000		81872
1.9 JTDM 8V	88	07/05 → 03/10	1.910	D	M	4	8	937A3.000		81352
2.0	121	07/02 → 05/05	1.970	B	M	4	16	937A1.000		81331
2.0 16V T.SPARK	110	01/01 → 03/10	1.970	B	AM	4	16	AR32310		81331
3.2 GTA	184	02/03 → 03/10	3.179	B	M	6	24	932A.000		81355

### 155

1.6 16V T.S.	88	05/96 → 12/97	1.598	B	M	4	16	AR67601	05-1996 →	81348
1.7 T.S.	83	04/93 → 04/96	1.748	B	M	4	8	AR67103		11708T
	85	04/93 → 04/96	1.748	B	M	4	8	AR67105		11708T
1.7 T.S. 16V	103	05/96 → 12/97	1.747	B	M	4	16	AR67106	05-1996 →	81348

**KW**

**cm<sup>3</sup>**

**NO. OF VALVES**

**MAGNETI MARELLI**
**ALFA ROMEO**
**155**

1.8 T.S.	77	02/92 → 12/97	1.756	B	M	4	8	AR67402	07-1993 →, → 04-1996	11708T
	95	02/92 → 06/93	1.773	B	M	4	8	AR67101	03-1992 →, → 06-1993	11708T
1.8 T.S. Sport	93	01/92 → 12/96	1.773	B	M	4	8	AR67101, AR67102	07-1993 →, → 04-1996	11708T
1.9 TD	66	04/93 → 12/97	1.929	D	M	4	8	AR67501	(-)COP, 02-1996 →, → 12-1997	81363
	66	04/93 → 12/97	1.929	D	M	4	8	AR67501	(-)COP, 04-1993 →, → 02-1996	81326
	66	04/93 → 12/97	1.929	D	M	4	8	AR67501	(+)COP, 02-1996 →, → 12-1997	81347
	66	04/93 → 12/97	1.929	D	M	4	8	AR67501	(+)COP, 04-1993 →, → 02-1996	81464
2.0 16V Turbo Q4	140	01/92 → 12/97	1.995	B	M	4	16	AR67203	07-1992 →, → 02-1996	81322
	137	01/92 → 12/97	1.995	B	M	4	16	AR67203	07-1992 →, → 02-1996	81322
2.0 T.S.	104	02/92 → 02/95	1.995	B	M	4	8	AR67202		11708T
	106	02/92 → 04/93	1.995	B	M	4	8	AR67201		11708T
2.0 T.S. 16V	110	03/95 → 12/97	1.970	B	M	4	16	AR67204, AR67299		81331
2.5 TD	92	04/93 → 12/97	2.499	D	M	4	8	VM07B, VM31B	04-1993 →	81302

**156, Sportwagon**

1.6 16V T.SPARK	82	09/97 → 09/05	1.598	B	M	4	16	AR32102		81348
	88	09/97 → 09/05	1.598	B	M	4	16	AR32102, AR32103, AR32104, AR67601	05-2000 →	81331
	88	09/97 → 09/05	1.598	B	M	4	16	AR32102, AR32103, AR32104, AR67601	11-1997 →, → 04-2000	81348
	88	05/00 → 05/06	1.598	B	M	4	16	AR32102, AR32103, AR32104, AR67601		81331
1.8 16V T.SPARK	103	10/00 → 09/05	1.747	B	M	4	16	AR32205		81348
	106	09/97 → 10/00	1.747	B	M	4	16	AR32201		81348
	106	05/00 → 10/00	1.747	B	M	4	16	AR32201		81331
1.9 JTD	93	11/03 → 09/05	1.910	D	M	4	16	937A4.000		81872
	100	11/02 → 11/04	1.910	D	M	4	16	192B1.000		81872
	110	07/04 → 09/05	1.910	D	M	4	16	937A5.000		81872
	77	09/97 → 10/00	1.910	D	M	4	8	AR32302		81352
	81	10/00 → 05/01	1.910	D	M	4	8	AR37101		81352
	85	05/01 → 09/05	1.910	D	M	4	8	937A2.000		81352
1.9 JTD 16V	103	11/02 → 09/05	1.910	D	M	4	16	192A5.000		81872
1.9 JTD 16V Q4	110	07/04 → 05/06	1.910	D	M	4	16	937A5.000		81872
2.0 16V T.SPARK	110	10/00 → 03/02	1.970	B	M	4	16	AR32310		81331
	114	09/97 → 10/00	1.970	B	M	4	16	AR32301	11-1997 →	81331
	114	05/00 → 06/02	1.970	B	M	4	16	AR32301		81331

		<b>KW</b>		<b>cm<sup>3</sup></b>				<b>NO. OF VALVES</b>			<b>MAGNETI MARELLI</b>
--	--	-----------	--	-----------------------	--	--	--	----------------------	--	--	------------------------

## ALFA ROMEO

### 156, Sportwagon

2.0 JTS	119	11/97 → 09/05	1.970	B	M	4	16	932A2.000		81331
	122	03/02 → 09/05	1.970	B	M	4	16	937A1.000		81331
2.4 JTD	120	06/03 → 09/05	2.387	D	M	5	20	841M.000, 841N.000		81872
	129	10/03 → 09/05	2.387	D	M	5	20	841G.000		81872
	100	09/97 → 09/03	2.387	D	M	5	10	AR32501		81352
	103	10/00 → 09/05	2.387	D	M	5	10	839A6.000		81352
	110	03/02 → 09/05	2.387	D	M	5	10	841C000		81352
2.5 V6 24V	140	05/00 → 08/03	2.492	B	M	6	24	AR32401		81355
	140	09/97 → 12/01	2.492	B	M	6	24	AR32401, AR32402	11-1997 →	81355
	141	10/00 → 09/05	2.492	B	M	6	24	AR32405		81355
3.2 GTA	184	03/02 → 09/05	3.179	B	M	6	24	932A.000		81355

### 159, Sportwagon

1.8 MPI	103	03/07 → 11/11	1.796	B	M	4	16	939A4.000		82083
1.8 TBi	147	05/09 → 11/11	1.742	B	M	4	16	939B1.000		81331
1.9 JTDM 16V	100	03/06 → 11/11	1.910	D	M	4	16	937A8.000		81872
	100	09/05 → 11/11	1.910	D	M	4	16	937A8.000, 939A8.000		81872
	110	09/05 → 11/11	1.910	D	M	4	16	939A2.000		81872
1.9 JTDM 8V	85	03/06 → 11/11	1.910	D	M	4	8	937A7.000		81352
	85	09/05 → 11/11	1.910	D	M	4	8	937A7.000, 939A7.000		81352
	88	09/05 → 11/11	1.910	D	M	4	8	939A1.000		81352
1.9 JTS	118	09/05 → 11/11	1.859	B	M	4	16	939A6.000		81812
2.0 JTDM	100	06/10 → 11/11	1.956	D	M	4	16	939B4.000		81872
	120	05/09 → 11/11	1.956	D	M	4	16	844A2.000		81872
	125	05/09 → 11/11	1.956	D	M	4	16	939B3.000		81872
2.2 JTS	136	09/05 → 11/11	2.198	B	M	4	16	939A5.000		81812
2.4 JTDM	147	09/05 → 11/11	2.387	D	M	5	20	939A3.000		81872
	154	05/07 → 11/11	2.387	D	M	5	20	939A9.000		81872
2.4 JTDM Q4	154	05/07 → 11/11	2.387	D	M	5	20	939A9.000		81872
3.2 JTS	191	02/08 → 11/11	3.195	B	M	6	24	939A.000		84057
3.2 JTS Q4	191	12/05 → 11/11	3.195	B	M	6	24	939A.000		84057

### 164

2.0 T.S.	106	09/92 → 09/98	1.995	B	M	4	8	AR64103		11708T
2.0 Turbo	128	10/87 → 09/98	1.995	B	M	4	8	AR06476		81443
	129	02/88 → 10/92	1.995	B	M	4	8	AR06476		81443
2.0 V6 Turbo	148	09/92 → 09/98	1.996	B	M	6	12	AR64102		19532/E
	150	03/91 → 09/92	1.996	B	M	6	12	AR64101		19532/E
2.5 TD	84	06/87 → 09/92	2.499	D	M	4	8	VM84A	10-1989 →	81302
	92	09/92 → 09/98	2.499	D	M	4	8	VM08B, VM32B	(-)COP	81362
2.5 V6	120	09/92 → 09/98	2.492	B	M	6	12	AR66201		19532/E
3.0 i.e. QV	147	09/90 → 09/92	2.959	B	M	6	12	AR06430, AR64301		19532/E
3.0 V6	132	09/92 → 09/98	2.959	B	M	6	12	AR64303, AR64305, AR64399, AR66303		19532/E
	135	06/87 → 09/92	2.959	B	M	6	12	AR06412		19532/E
	141	06/87 → 09/92	2.959	B	M	6	12	AR06410		19532/E

**KW**

**cm<sup>3</sup>**

**NO. OF VALVES**

**MAGNETI MARELLI**
**ALFA ROMEO**

<b>166</b>										
2.0 T.Spark	110	10/00 → 06/07	1.970	B	M	4	16	AR36301		81331
	114	09/98 → 10/00	1.970	B	M	4	16	AR34103		81331
2.0 V6	151	09/98 → 10/00	1.996	B	M	6	12	AR34102		81355
2.4 JTD	110	04/02 → 06/07	2.387	D	M	5	10	841C000		81352
	120	10/03 → 06/07	2.387	D	M	5	20	841M.000, 841N.000		81872
	129	10/03 → 06/07	2.387	D	M	5	20	841G.000, 841H.000		81872
	132	07/06 → 06/07	2.387	D	M	5	20	841M.000		81872
	136	07/05 → 06/07	2.387	D	M	5	20	841M.000, 936B.000		81872
	100	09/98 → 10/00	2.387	D	M	5	10	AR34202		81352
	103	10/00 → 06/07	2.387	D	M	5	10	839A6.000		81352
2.5 V6 24V	138	10/00 → 06/07	2.492	B	M	6	24	AR36201		81355
	140	09/98 → 10/00	2.492	B	M	6	24	AR34201		81355
3.0 V6 24V	162	10/00 → 06/07	2.959	B	AM	6	24	AR36101		81355
	166	09/98 → 10/00	2.959	B	M	6	24	AR34301, AR34302		81355
3.2 V6 24V	176	10/03 → 06/07	3.179	B	M	6	24	936A.000	M: AR34301/36101	81355

<b>Brera</b>										
1.8 TBi	147	05/09 → 06/10	1.742	B	M	4	16	939B1.000		81331
2.0 JTDM	120	03/08 → 06/10	1.956	D	M	4	16	844A2.000		81872
	125	05/09 → 06/10	1.956	D	M	4	16	939B3.000		81872
2.2 JTS	136	01/06 → 06/10	2.198	B	M	4	16	939A5.000		81812
2.4 JTDM 20V	147	01/06 → 06/10	2.387	D	M	5	20	939A3.000		81872
	154	05/07 → 06/10	2.387	D	M	5	20	939A9.000		81872
3.2 JTS	191	03/08 → 06/10	3.195	B	M	6	24	939A.000		84057 <b>NEW</b>
3.2 JTS Q4	191	01/06 → 06/10	3.195	B	M	6	24	939A.000		84057 <b>NEW</b>

<b>Giulietta III</b>										
1.4 BiFuel	88	12/11 →	1.368	BF	M	4	16	198A4.000	TESMA	82070
1.4 TB	77	04/11 →	1.368	B	M	4	16	940B1.000, 940B8.000	TESMA	82070
	85	04/10 →	1.368	B	M	4	16	940A6.000	TESMA	82070
	88	04/10 →	1.368	B	M	4	16	198A4.000, 940B7.000	TESMA	82070
	110	09/14 →	1.368	B	M	4	16	940A2.000	TESMA	82070
	120	04/10 →	1.368	B	M	4	16	955A8.000	TESMA	82070
	125	04/10 →	1.368	B	M	4	16	940A2.000	TESMA	82070
	1.6 JTDM	77	04/10 →	1.598	D	M	4	16	940A3.000	
1.8 TBi	173	04/10 →	1.742	B	M	4	16	940A1.000		81331
	177	09/13 →	1.742	B	M	4	16	960A1.000		81331
2.0 JTDM	100	04/10 →	1.956	D	M	4	16	940A8.000, 940B6.000		81872
	103	04/10 →	1.956	D	M	4	16	940A5.000		81872
	110	08/13 →	1.956	D	M	4	16	940B5.000		81872
	120	04/10 →	1.956	D	M	4	16	940A7.000		81872
	125	04/10 →	1.956	D	M	4	16	940A4.000		81872
2.0 JTDM	129	11/13 →	1.956	D	M	4	16	940B4.000		81872

		<b>KW</b>		<b>cm<sup>3</sup></b>				<b>NO. OF VALVES</b>			<b>MAGNETI MARELLI</b>
--	--	-----------	--	-----------------------	--	--	--	----------------------	--	--	------------------------

## ALFA ROMEO

### GT II

1.8 TS	103	11/03 → 09/10	1.747	B	M	4	16	AR32205		81348
1.9 JTD	110	11/03 → 09/10	1.910	D	M	4	16	937A5.000		81872
	125	05/08 → 09/10	1.910	D	M	4	16	937A6.000		81872
2.0 JTS	119	12/06 → 09/10	1.970	B	M	4	16	932A2.000		81331
	121	11/03 → 09/10	1.970	B	M	4	16	932A2.000, 937A1.000		81331
3.2 GTA	176	11/03 → 09/10	3.179	B	M	6	24	936A.000		81355

### GTV II

1.8 16V	106	05/98 → 10/05	1.747	B	M	4	16	AR32201		81331
2.0 JTS	121	04/03 → 10/05	1.970	B	M	4	16	937A1.000		81331
2.0 T.SPARK 16V	110	06/95 → 10/05	1.970	B	M	4	16	AR16201, AR32310		81331
	114	05/98 → 08/00	1.970	B	M	4	16	AR32301		81331
3.0 V6 24V	162	10/96 → 10/00	2.959	B	M	6	24	AR16102		81355
3.2 V6 24V	176	04/03 → 10/05	3.179	B	M	6	24	936A6.000	M: AR16102	81355

### Mito

0.9	74	12/13 →	875	B	M	2	8	199B6.000		84008
0.9 TwinAir	63	07/11 →	875	B	M	2	8	312A2.000		84008
	77	04/13 →	875	B	M	2	8	199B6.000		84008
1.3 MultiJet	59	12/13 →	1.248	D	M	4	16	199B8.000		81862
	62	01/11 →	1.248	D	M	4	16	199B4.000		81862
	66	09/08 →	1.248	D	M	4	16	199A3.000		81862
	70	10/09 →	1.248	D	M	4	16	199B1.000		81862
1.4 I4	51	05/11 →	1.368	B	M	4	8	955A9.000	TESMA	82070
	57	03/11 →	1.368	B	M	4	8	350A1.000	TESMA	82070
	57	03/11 →	1.368	B	M	4	16	955A1.000	TESMA	82070
	58	09/08 →	1.368	B	M	4	16	955A1.000	PIERBURG	81369
	58	09/08 →	1.368	B	M	4	16	955A1.000	TESMA	82070
	70	09/08 →	1.368	B	M	4	16	199A6.000	PIERBURG	81369
1.4 Bifuel	88	07/11 →	1.368	BF	M	4	16	198A4.000	TESMA	82070
1.4 MultiAir	77	08/10 →	1.368	B	M	4	16	955A6.000	TESMA	82070
1.4 TB	103	12/13 →	1.368	B	M	4	16	955B1.000	TESMA	82070
1.4 TJet	88	09/08 →	1.368	B	M	4	16	198A4.000	PIERBURG	81369
	88	09/08 →	1.368	B	M	4	16	198A4.000	TESMA	82070
	110	09/08 →	1.368	B	M	4	16	198A1.000	TESMA	82070
	114	09/08 →	1.368	B	M	4	16	199A8.000	TESMA	82070
1.4 Turbo MultiAir	99	10/09 →	1.368	B	M	4	16	955A2.000, 955A7.000	TESMA	82070
	120	10/09 →	1.368	B	M	4	16	955A8.000	TESMA	82070
	125	10/09 →	1.368	B	M	4	16	940A2.000	TESMA	82070
1.6 JTDM	85	09/08 →	1.598	D	M	4	16	955A4.000		81872
	88	09/08 →	1.598	D	M	4	16	198A2.000, 955A3.000		81872

**KW**

**cm<sup>3</sup>**

**NO. OF VALVES**

**MAGNETI MARELLI**

## ALFA ROMEO

### Spider III

1600	76	03/76 → 12/90	1.570	B	M	4	8	AR00526	→ 12-1985	11701T
	76	03/76 → 12/90	1.570	B	M	4	8	AR00526	01-1989 →	11701T
	79	01/90 → 12/93	1.570	B	M	4	8	AR01563		11701T
2000	85	08/86 → 12/90	1.962	B	M	4	8	AR01544	01-1989 →	11701T
	88	01/90 → 12/93	1.962	B	M	4	8	AR01588		11701T
	92	08/86 → 12/90	1.962	B	M	4	8	AR00515	01-1989 →	11701T
2000 Veloce	93	01/77 → 12/93	1.962	B	M	4	8	AR00515, AR01590	01-1978 →, → 12-1985	11701T
	93	01/77 → 12/93	1.962	B	M	4	8	AR00515, AR01590	01-1989 →	11701T

### Spider IV

1.8 16V	106	05/98 → 04/05	1.747	B	M	4	16	AR32201		81331
2.0 JTS	121	04/03 → 04/05	1.970	B	M	4	16	937A1.000		81331
2.0 T.SPARK 16V	110	06/95 → 04/05	1.970	B	M	4	16	AR16201, AR32310		81331
	114	05/98 → 08/00	1.970	B	M	4	16	AR32301		81331
3.0 V6 24V	162	01/99 → 10/03	2.959	B	M	6	24	AR16102		81355
3.2 V6 24V	176	04/03 → 04/05	3.179	B	M	6	24	936A6.000		81355

### Spider V

1.8 TBi	147	05/09 → 06/10	1.742	B	M	4	16	939B1.000		81331
2.0 JTDM	120	04/09 → 06/10	1.956	D	M	4	16	844A2.000		81872
	125	05/09 → 06/10	1.956	D	M	4	16	939B3.000		81872
2.2 JTS	136	03/06 → 06/10	2.198	B	M	4	16	939A5.000		81812
2.4 JTDM	147	04/07 → 06/10	2.387	D	M	5	20	939A3.000		81872
	154	03/08 → 06/10	2.387	D	M	5	20	939A3.000		81872
3.2 JTS	191	03/08 → 06/10	3.195	B	M	6	24	939A.000		84057 <b>NEW</b>
3.2 JTS Q4	191	03/06 → 06/10	3.195	B	M	6	24	939A.000		84057 <b>NEW</b>

## AUDI

### 80 IV

1.6	51	08/87 → 09/91	1.595	B	M	4	8	PP	(-)COP	81522
	51	08/87 → 09/91	1.595	B	M	4	8	PP	(+)COP	82080
	55	09/86 → 08/91	1.595	B	M	4	8	RN	(-)COP	81522
	55	09/86 → 08/91	1.595	B	M	4	8	RN	(+)COP	82080
	75	08/90 → 10/91	1.595	B	M	4	8	ABB	(-)COP	81522
	75	08/90 → 10/91	1.595	B	M	4	8	ABB	(+)COP	82080
1.6 TD	59	09/86 → 08/91	1.588	D	M	4	8	RA, SB	(-)COP	81522
	59	09/86 → 08/91	1.588	D	M	4	8	RA, SB	(+)COP	82080
1.8	55	10/86 → 01/90	1.781	B	M	4	8	RU	(-)COP	81522
	55	10/86 → 01/90	1.781	B	M	4	8	RU	(+)COP	82080
1.8 E	82	06/86 → 08/91	1.781	B	M	4	8	DZ	(-)COP	81522
	82	06/86 → 08/91	1.781	B	M	4	8	DZ	(+)COP	82080
1.8 E quattro	82	09/86 → 08/91	1.781	B	M	4	8	DZ	(-)COP	81522
	82	09/86 → 08/91	1.781	B	M	4	8	DZ	(+)COP	82080
1.8 quattro	83	09/86 → 08/90	1.847	B	M	4	8	SD	(-)COP	81522
	83	09/86 → 08/90	1.847	B	M	4	8	SD	(+)COP	82080

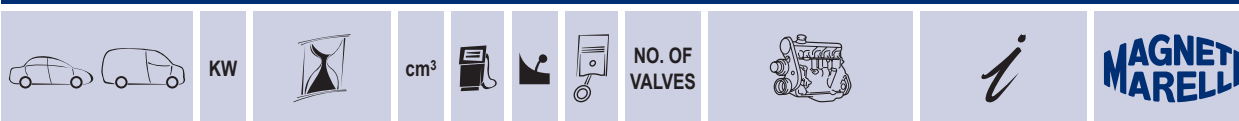

**AUDI**
**80 IV**

1.8 S	65	08/86 → 01/90	1.781	B	M	4	8	SF	(-)COP	81522
	65	08/86 → 01/90	1.781	B	M	4	8	SF	(+)COP	82080
	66	09/86 → 10/91	1.781	B	M	4	8	JN, NE, PM	(-)COP	81522
	66	09/86 → 10/91	1.781	B	M	4	8	JN, NE, PM	(+)COP	82080
1.8 S quattro	65	09/86 → 07/90	1.781	B	M	4	8	SF	(-)COP	81522
	65	09/86 → 07/90	1.781	B	M	4	8	SF	(+)COP	82080
	66	09/86 → 09/91	1.781	B	M	4	8	JN, NE, PM	(-)COP	81522
1.9 D	50	08/89 → 08/91	1.896	D	M	4	8	1Y	(-)COP	81522
	50	08/89 → 08/91	1.896	D	M	4	8	1Y	(+)COP	82080
2.0	82	10/90 → 08/91	1.984	B	M	4	8	AAD	(-)COP	81522
	82	10/90 → 08/91	1.984	B	M	4	8	AAD	(+)COP	82080
2.0 E	83	08/88 → 10/90	1.984	B	M	4	8	3A	(-)COP	81522
	83	08/88 → 10/90	1.984	B	M	4	8	3A	(+)COP	82080
2.0 E 16V	101	03/90 → 09/91	1.984	B	M	4	16	6A	(-)COP	81522
	101	03/90 → 09/91	1.984	B	M	4	16	6A	(+)COP	82080
2.0 E 16V quattro	101	03/90 → 08/91	1.984	B	M	4	16	6A	(-)COP	81522
	101	03/90 → 08/91	1.984	B	M	4	16	6A	(+)COP	82080
2.0 E quattro	83	08/88 → 09/90	1.984	B	M	4	8	3A	(-)COP	81522
	83	08/88 → 09/90	1.984	B	M	4	8	3A	(+)COP	82080
2.0 quattro	82	08/88 → 07/90	1.984	B	M	4	8	3A	(-)COP	81522
	82	08/88 → 07/90	1.984	B	M	4	8	3A	(+)COP	82080
	85	10/90 → 08/91	1.984	B	M	4	8	AAD	(-)COP	81522
	85	10/90 → 08/91	1.984	B	M	4	8	AAD	(+)COP	82080

**80 V, Avant**

1.6	52	09/91 → 12/94	1.595	B	M	4	8	ABM	(-)COP	81522
	52	09/91 → 12/94	1.595	B	M	4	8	ABM	(+)COP	82080
1.6 E	74	06/93 → 12/94	1.595	B	M	4	8	ADA	(-)COP	81522
	74	06/93 → 12/94	1.595	B	M	4	8	ADA	(+)COP	82080
1.9 TD	55	09/91 → 12/94	1.896	D	M	4	8	AAZ	(-)COP	81522
	55	09/91 → 12/94	1.896	D	M	4	8	AAZ	(+)COP	82080
1.9 TDI	66	09/91 → 12/94	1.896	D	M	4	8	1Z	(-)COP	81522
	66	09/91 → 12/94	1.896	D	M	4	8	1Z	(+)COP	82080
2.0	66	09/91 → 12/94	1.984	B	M	4	8	ABT	(-)COP	81522
	66	09/91 → 12/94	1.984	B	M	4	8	ABT	(+)COP	82080
2.0 E	85	09/91 → 12/94	1.984	B	M	4	8	ABK	(-)COP	81522
	85	09/91 → 12/94	1.984	B	M	4	8	ABK	(+)COP	82080
2.0 E 16V	103	08/92 → 12/94	1.984	B	M	4	16	ACE	(-)COP	81522
	103	08/92 → 12/94	1.984	B	M	4	16	ACE	(+)COP	82080
2.0 E 16V quattro	103	04/92 → 12/94	1.984	B	M	4	16	ACE	(-)COP	81522
	103	04/92 → 12/94	1.984	B	M	4	16	ACE	(+)COP	82080
2.0 E quattro	85	09/91 → 12/94	1.984	B	M	4	8	ABK	(-)COP	81522
	85	09/91 → 12/94	1.984	B	M	4	8	ABK	(+)COP	82080

**KW**

**cm<sup>3</sup>**

**NO. OF VALVES**

**AUDI**
**80 V, Avant**

2.0 quattro	79	11/93 → 01/96	1.984	B	M	4	8	ADW	(-)COP	81522
	79	11/93 → 01/96	1.984	B	M	4	8	ADW	(+)COP	82080
2.3 E	98	09/91 → 12/94	2.309	B	M	5	10	NG		81700
2.3 E quattro	98	09/91 → 12/94	2.309	B	M	5	10	NG		81700
RS2 quattro	232	03/94 → 05/95	2.226	B	M	5	20	ADU		81700
S2 quattro	169	02/93 → 12/94	2.226	B	M	5	20	ABY		81700

**90 II**

1.6 TD	59	04/87 → 09/91	1.588	D	M	4	8	RA, SB	(-)COP	81522
	59	04/87 → 09/91	1.588	D	M	4	8	RA, SB	(+)COP	82080
2.0	85	07/88 → 09/91	1.994	B	M	5	10	PS	T →: F89-J-394.743	81683
2.0 20 V	118	08/89 → 07/91	1.994	B	M	5	20	NM		81683
2.0 20 V quattro	118	08/88 → 09/91	1.994	B	M	5	20	NM		81683
2.0 quattro	101	08/89 → 07/90	1.984	B	M	4	16	6A	(-)COP	81522
	101	08/89 → 07/90	1.984	B	M	4	16	6A	(+)COP	82080
2.2 E	100	04/87 → 07/91	2.226	B	M	5	10	KV	T →: F89-J-394.743	81683
2.2 E quattro	100	04/87 → 09/91	2.226	B	M	5	10	KV	T →: F89-J-394.743	81683
2.3 E	98	04/87 → 09/91	2.309	B	M	5	10	NG	T →: F89-J-394.743	81683
	100	04/87 → 07/91	2.309	B	M	5	10	NG	T →: F89-J-394.743	81683
2.3 E 20V	123	04/90 → 07/91	2.309	B	M	5	20	7A		81683
	125	08/88 → 07/91	2.309	B	M	5	20	7A		81683
2.3 E 20V quattro	123	04/90 → 09/91	2.309	B	M	5	20	7A		81683
	125	06/88 → 09/91	2.309	B	M	5	20	7A		81683
2.3 E quattro	98	04/87 → 09/91	2.309	B	M	5	10	NG	T →: F89-J-394.743	81683
	100	04/87 → 07/91	2.309	B	M	5	10	NG	T →: F89-J-394.743	81683

**100 III, Avant**

1.8	65	02/86 → 07/90	1.781	B	M	4	8	SH	(-)COP	81522
	65	02/86 → 07/90	1.781	B	M	4	8	SH	(+)COP	82080
1.8 Cat.	66	03/85 → 11/90	1.781	B	M	4	8	4B, PH	(-)COP	81522
	66	03/85 → 11/90	1.781	B	M	4	8	4B, PH	(+)COP	82080
1.8 quattro	65	08/86 → 07/90	1.781	B	M	4	8	SH	(-)COP	81522
	65	08/86 → 07/90	1.781	B	M	4	8	SH	(+)COP	82080
1.8 quattro Cat.	66	08/85 → 11/90	1.781	B	M	4	8	4B, PH	(-)COP	81522
	66	08/85 → 11/90	1.781	B	M	4	8	4B, PH	(+)COP	82080
2.0 Cat.	85	01/88 → 11/90	1.994	B	M	5	10	RT	M →: 010.236	81683
2.0 D	51	03/83 → 11/90	1.986	D	M	5	10	CN	→ 05-1990, → T: F-L-100.000	81593
2.0 D Turbo	74	03/88 → 11/90	1.986	D	M	5	10	NC	→ 05-1990, → T: F-L-100.000	81593
2.0 E Cat.	85	01/88 → 11/90	1.994	B	M	5	10	RT	M →: 010.236	81683
2.0 TD	74	03/88 → 11/90	1.986	D	M	5	10	NC	→ 05-1990, → T: F-L-100.000	81593
2.2 Cat.	101	06/89 → 11/90	2.226	B	M	5	10	HX, KU		81683
2.2 E Turbo quattro	121	08/86 → 11/90	2.226	B	M	5	10	MC	05-1988 →, M →: 039.951	81683

--	--	--	--	--	--	--	--	--	--

## AUDI

### 100 III, Avant

2.2 quattro Cat.	101	06/89 → 11/90	2.226	B	M	5	10	HX, KU		81683
2.2 Turbo	121	08/86 → 11/90	2.226	B	M	5	10	MC	05-1988 →, M →: 039.951	81683
2.2 Turbo quattro	121	08/86 → 11/90	2.226	B	M	5	10	MC	05-1988 →, M →: 039.951	81683
2.3	98	03/90 → 11/90	2.309	B	M	5	10	NF		81683
	100	08/86 → 11/90	2.309	B	M	5	10	NF	05-1988 →, M →: 063.969	81683
2.3 E	98	01/90 → 11/90	2.309	B	M	5	10	NF		81683
	100	10/86 → 11/90	2.309	B	M	5	10	NF	05-1988 →, M →: 063.969	81683
2.3 E quattro	100	08/86 → 11/90	2.309	B	M	5	10	NF	05-1988 →, M →: 063.969	81683
2.3 quattro	98	01/90 → 11/90	2.309	B	M	5	10	NF		81683
2.4 D	60	08/89 → 07/91	2.370	D	M	5	10	3D	→ 05-1990, → T: F-L-100.000	81593

### 100 IV, Avant

2.0	74	12/90 → 06/94	1.984	B	M	4	8	AAE	(-)COP	81522
	74	12/90 → 06/94	1.984	B	M	4	8	AAE	(+)COP	82080
2.0 E	74	09/91 → 06/94	1.984	B	M	4	8	AAE	(-)COP	81522
	74	09/91 → 06/94	1.984	B	M	4	8	AAE	(+)COP	82080
	85	12/90 → 06/94	1.984	B	M	4	8	AAD, ABK	(-)COP	81522
	85	12/90 → 06/94	1.984	B	M	4	8	AAD, ABK	(+)COP	82080
2.0 E 16V	103	01/92 → 06/94	1.984	B	M	4	16	ACE	(-)COP	81522
	103	01/92 → 06/94	1.984	B	M	4	16	ACE	(+)COP	82080
2.0 E 16V quattro	103	07/92 → 06/94	1.984	B	M	4	16	ACE	(-)COP	81522
	103	07/92 → 06/94	1.984	B	M	4	16	ACE	(+)COP	82080
2.0 E quattro	85	12/90 → 07/92	1.984	B	M	4	8	AAD	(-)COP	81522
	85	12/90 → 07/92	1.984	B	M	4	8	AAD	(+)COP	82080
2.3 E	98	12/90 → 06/94	2.309	B	M	5	10	AAR		81700
2.3 E quattro	98	12/90 → 06/94	2.309	B	M	5	10	AAR		81700
2.4 D	60	12/90 → 06/94	2.370	D	M	5	10	AAS		81701
2.5 TDI	85	12/90 → 06/94	2.461	D	M	5	10	AAT, ABP		81701
S4 Turbo quattro	169	08/91 → 06/94	2.226	B	M	5	20	AAN		81700

### 200 II, Avant

2.2 20V Turbo quattro	162	03/89 → 12/90	2.226	B	M	5	20	3B	T →: F44-J-246.282	81683
2.2 Turbo	121	08/85 → 09/91	2.226	B	M	5	10	MC	M →: 039.951	81683
	140	02/88 → 12/90	2.226	B	M	5	10	2B	M →: 001.069	81683
	147	02/88 → 12/90	2.226	B	M	5	10	1B	M →: 001.571	81683
2.2 Turbo quattro	121	01/85 → 12/91	2.226	B	M	5	10	MC	M →: 039.951	81683
	147	02/88 → 11/90	2.226	B	M	5	10	1B	M →: 001.571	81683
2.3	100	11/86 → 09/91	2.309	B	M	5	10	NF		81683

**KW**

**cm<sup>3</sup>**

**NO. OF VALVES**

**MAGNETI MARELLI**
**AUDI**
**A1, Sportback**

1.2 TFSI	63	05/10 →	1.197	B	M	4	8	CBZA		84045	<b>NEW</b>
1.4 TFSI	90	05/10 →	1.390	B	M	4	16	CAXA, CNVA		82097	
	136	11/11 →	1.390	B	M	4	16	CAVG, CTHG, CTJA		82097	
	92	11/14 →	1.395	B	M	4	16	CZCA, CZDB		84062	<b>NEW</b>
	103	04/12 →	1.395	B	M	4	16	CPTA		84062	<b>NEW</b>
	110	11/14 →	1.395	B	M	4	16	CZEA		84062	<b>NEW</b>
1.6 TDI	66	03/11 →	1.598	D	M	4	16	CAYB		84001	
	77	05/10 →	1.598	D	M	4	16	CAYC		84001	
1.8 TFSI	141	02/15 →	1.798	B	M	4	16	DAJB		84037	<b>NEW</b>
2.0 TDI	100	05/12 →	1.968	D	M	4	16	CFHB		84001	
	105	09/11 →	1.968	D	M	4	16	CFHD		84001	
2.0 TFSI quattro	188	03/12 →	1.984	B	M	4	16	CDLH		82025	
S1 quattro	170	03/14 →	1.984	B	M	4	16	CWZA		84037	<b>NEW</b>

**A2**

1.2 TDI	45	03/01 → 08/05	1.191	D	M	3	6	ANY		84010	<b>NEW</b>
	45	03/01 → 08/05	1.191	D	M	3	6	ANY		81791	
1.4	55	02/00 → 08/05	1.390	B	M	4	16	AUA, BBY		81777	
1.4 TDI	55	02/00 → 08/05	1.422	D	M	3	6	AMF, BHC		84010	<b>NEW</b>
	55	02/00 → 08/05	1.422	D	M	3	6	AMF, BHC		81791	
	66	11/03 → 08/05	1.422	D	M	3	6	ATL		84010	<b>NEW</b>
	66	11/03 → 08/05	1.422	D	M	3	6	ATL		81791	
1.6 FSI	81	05/02 → 08/05	1.598	B	M	4	16	BAD		81840	

**A3 I**

1.6	74	09/96 → 05/03	1.595	B	M	4	8	AEH, AKL, APF		81702	
	75	08/00 → 05/03	1.595	B	AM	4	8	AVU, BFQ		81702	
1.8	92	09/96 → 05/03	1.781	B	AM	4	20	AGN, APG		81703	
1.8 T	110	12/96 → 05/03	1.781	B	M	4	20	AGU, AQA, ARZ, AUM		81703	
	132	12/98 → 05/03	1.781	B	M	4	20	AJQ, APP, ARY, AUQ		81703	
1.8 T quattro	110	12/96 → 05/03	1.781	B	M	4	20	AGU, AQA, ARX		81703	
	132	10/98 → 05/03	1.781	B	M	4	20	AJQ, ARY		81703	
1.9 TDI	66	09/96 → 07/01	1.896	D	M	4	8	AGR, ALH	T →: F8L-V-115.001	81706	
	74	10/00 → 05/03	1.896	D	M	4	8	ATD, AXR		81816	
	74	10/00 → 05/03	1.896	D	M	4	8	ATD, AXR		84011	<b>NEW</b>
	81	08/97 → 07/01	1.896	D	M	4	8	AHF, ASV	T →: F8L-V-115.001	81706	
	96	08/00 → 05/03	1.896	D	AM	4	8	ASZ		81816	
	96	08/00 → 05/03	1.896	D	AM	4	8	ASZ		84011	<b>NEW</b>
1.9 TDI quattro	96	08/00 → 05/03	1.896	D	M	4	8	ASZ		81816	
	96	08/00 → 05/03	1.896	D	M	4	8	ASZ		84011	<b>NEW</b>
S3 quattro	154	03/99 → 04/02	1.781	B	M	4	20	AMK, APY, AUL		81703	
	165	10/01 → 05/03	1.781	B	M	4	20	BAM		81703	

		<b>KW</b>		<b>cm<sup>3</sup></b>				<b>NO. OF VALVES</b>			
--	--	-----------	--	-----------------------	--	--	--	----------------------	--	--	--

## AUDI

### A3 II, Sportback, Cabriolet

1.2 TFSI	77	03/10 → 05/13	1.197	B	M	4	8	CBZB		84045	
1.2 TSI	77	04/10 → 08/12	1.197	B	M	4	8	CBZB		84045	
1.4 TFSI	92	02/11 → 05/13	1.390	B	M	4	16	CAXC		82097	
	92	09/07 → 08/12	1.390	B	M	4	16	CAXC, CMSA		82097	
1.6	75	05/03 → 08/12	1.595	B	M	4	8	BGU, BSE, BSF, CCSA, CMXA		81702	
	75	09/08 → 05/10	1.595	B	M	4	8	BSE		81702	
1.6 E-Power	75	01/11 → 08/12	1.595	FF	M	4	8	CCSA, CMXA		81702	
1.6 FSI	85	08/03 → 09/07	1.598	B	M	4	16	BAG, BLF, BLP		81865	
	85	09/04 → 09/07	1.598	B	M	4	16	BLF, BLP		81865	
1.6 TDI	66	05/09 → 08/12	1.598	D	M	4	16	CAYB		84001	
	77	05/09 → 08/12	1.598	D	M	4	16	CAYC		84001	
1.8 T	110	08/06 → 08/12	1.781	B	M	4	20	BPU		81702	
1.8 TFSI	118	11/06 → 08/12	1.798	B	M	4	16	BYT, BZB, CDAA		84016	
	118	04/08 → 05/13	1.798	B	M	4	16	BZB, CDAA		84016	
1.8 TFSI quattro	118	07/08 → 08/12	1.798	B	M	4	16	CDAA		84016	
1.9 TDI	77	05/03 → 05/10	1.896	D	M	4	8	BKC, BLS, BXE		84010	
	77	05/03 → 05/10	1.896	D	M	4	8	BKC, BLS, BXE		81791	
	77	04/08 → 10/09	1.896	D	M	4	8	BLS		84010	
	77	04/08 → 10/09	1.896	D	M	4	8	BLS		81791	
2.0 FSI	110	05/03 → 06/08	1.984	B	M	4	16	AXW, BLR, BLX, BLY, BMB, BVY, BVZ		81702	
2.0 TDI	100	05/03 → 08/12	1.968	D	M	4	16	AZV, CBAA, CFFA		81816	
	100	05/03 → 08/12	1.968	D	M	4	16	AZV, CBAA, CFFA		84011	
	100	04/08 → 05/13	1.968	D	M	4	16	CBAA, CFFA		81816	
	100	04/08 → 05/13	1.968	D	M	4	16	CBAA, CFFA		84011	
	103	06/05 → 06/08	1.968	D	M	4	8	BMM		81816	
	103	06/05 → 06/08	1.968	D	M	4	8	BMM		84011	
	103	04/08 → 05/13	1.968	D	M	4	16	CBAB, CFFB		81816	
	103	04/08 → 05/13	1.968	D	M	4	16	CBAB, CFFB		84011	
	120	06/06 → 06/08	1.968	D	M	4	16	BUY		81816	
	120	06/06 → 06/08	1.968	D	M	4	16	BUY		84011	
	125	03/06 → 08/12	1.968	D	M	4	16	BMN, CBBB, CFGB		81816	
	125	03/06 → 08/12	1.968	D	M	4	16	BMN, CBBB, CFGB		84011	
2.0 TDI 16V	103	05/03 → 08/12	1.968	D	M	4	16	BKD, CBAB, CFFB, CLJA		81816	
	103	05/03 → 08/12	1.968	D	M	4	16	BKD, CBAB, CFFB, CLJA		84011	
2.0 TDI 16V quattro	103	08/04 → 08/12	1.968	D	M	4	16	BKD, CBAB, CFFB		81816	
	103	08/04 → 08/12	1.968	D	M	4	16	BKD, CBAB, CFFB		84011	
	103	11/05 → 03/13	1.968	D	M	4	16	BKD, CBAB, CFFB	M: BKD	81816	

**KW**

**cm<sup>3</sup>**

**NO. OF VALVES**

**MAGNETI MARELLI**
**AUDI**
**A3 II, Sportback, Cabriolet**

2.0 TDI quattro	100	05/03 → 06/08	1.968	D	M	4	16	AZV		81816	
	100	05/03 → 06/08	1.968	D	M	4	16	AZV		84011	<b>NEW</b>
	103	01/06 → 06/08	1.968	D	M	4	8	BMM		81816	
	103	01/06 → 06/08	1.968	D	M	4	8	BMM		84011	<b>NEW</b>
	125	03/06 → 08/12	1.968	D	M	4	16	BMN, CBBB, CFGB		81816	
	125	03/06 → 08/12	1.968	D	M	4	16	BMN, CBBB, CFGB		84011	<b>NEW</b>
2.0 TFSI	147	09/04 → 03/13	1.984	B	M	4	16	AXX, BPY, BWA, CAWB, CBFA, CCZA		82025	
	147	09/04 → 08/12	1.984	B	M	4	16	AXX, BWA, CAWB, CCZA		82025	
2.0 TFSI	147	04/08 → 05/13	1.984	B	M	4	16	CAWB, CCZA		84016	<b>NEW</b>
2.0 TFSI quattro	147	09/04 → 03/13	1.984	B	M	4	16	AXX, BPY, BWA, CCZA		82025	
	147	09/04 → 08/12	1.984	B	M	4	16	AXX, BWA, CCTA, CCZA		82025	
3.2 V6 quattro	184	07/03 → 05/09	3.189	B	M	6	24	BDB, BMJ, BUB		81866	
	184	09/04 → 05/09	3.189	B	M	6	24	BMJ, BUB		81866	
S3 quattro	188	02/07 → 08/12	1.984	B	M	4	16	BZC, CDLC		82025	
	188	07/08 → 03/13	1.984	B	M	4	16	CDLC		82025	
	195	11/06 → 08/12	1.984	B	M	4	16	BHZ, CDLA		82025	

**A3 III, Sportback, Cabriolet**

1.2 TFSI	77	02/13 →	1.197	B	M	4	16	CJZA		84062	<b>NEW</b>
	81	05/14 →	1.197	B	M	4	16	CYVB		84062	<b>NEW</b>
1.4 TFSI	85	02/16 →	1.395	B	M	4	16	CZCC		84062	<b>NEW</b>
	90	04/12 →	1.395	B	M	4	16	CMBA, CXSA		84062	<b>NEW</b>
	92	05/14 →	1.395	B	M	4	16	CXSB, CZCA		84062	<b>NEW</b>
	103	03/13 →	1.395	B	M	4	16	CPTA		84062	<b>NEW</b>
	110	05/14 →	1.395	B	M	4	16	CZEA		84062	<b>NEW</b>
1.4 TFSI e-tron	110	05/14 →	1.395		M	4	16	CUKB, CXUA		84062	<b>NEW</b>
	81	11/13 →	1.395		M	4	16	CPWA		84062	<b>NEW</b>
1.8 TFSI	125	05/14 →	1.798	B	M	4	16	CNSB		84037	<b>NEW</b>
	132	04/12 →	1.798	B	M	4	16	CJSA		84037	<b>NEW</b>
	132	05/13 →	1.798	B	M	4	16	CJSA, CJSB		84037	<b>NEW</b>
1.8 TFSI quattro	132	08/12 →	1.798	B	M	4	16	CJSB		84037	<b>NEW</b>
S3 quattro	206	02/13 →	1.984	B	M	4	16	CJXB		84037	<b>NEW</b>
	210	05/14 →	1.984	B	M	4	16	CJXF		84037	<b>NEW</b>
S3 quattro	221	11/12 →	1.984	B	M	4	16	CJXC		84037	<b>NEW</b>

		KW		cm <sup>3</sup>				NO. OF VALVES			
--	--	----	--	-----------------	--	--	--	---------------	--	--	--

## AUDI

### A4 I, Avant

1.6	74	11/94 → 09/01	1.595	B	M	4	8	ADP, AHL, ANA, ARM	(-)COP, 03-1996 →, → 12-1997	81526
	74	11/94 → 09/01	1.595	B	M	4	8	ADP, AHL, ANA, ARM	(+)COP, 03-1996 →, → 12-1997	81529
	74	11/94 → 10/00	1.595	B	M	4	8	ADP, AHL, ANA, ARM	(-)COP, 01-1995 →, → 12-1997	81526
	74	11/94 → 10/00	1.595	B	M	4	8	ADP, AHL, ANA, ARM	(+)COP, 01-1995 →, → 12-1997	81529
	74	11/94 → 10/00	1.595	B	M	4	8	ADP, AHL, ANA, ARM	12-1997 →, → 07-2000, M: AHL/ ANA/ARM	81702
	75	07/00 → 11/00	1.595	B	M	4	8	ALZ		81702
1.81.8	85	04/95 → 11/00	1.781	B	M	4	20	AFY	(-)COP	81526
	85	04/95 → 11/00	1.781	B	M	4	20	AFY	(+)COP	81529
	92	01/95 → 11/00	1.781	B	M	4	20	ADR, APT, ARG, AVV	(-)COP	81526
	92	01/95 → 11/00	1.781	B	M	4	20	ADR, APT, ARG, AVV	(+)COP	81529
	95	01/95 → 11/00	1.781	B	M	4	20	ADR	(-)COP	81526
	95	01/95 → 11/00	1.781	B	M	4	20	ADR	(+)COP	81529
1.8 quattro	85	07/95 → 11/00	1.781	B	M	4	20	AFY	(-)COP	81526
	85	07/95 → 11/00	1.781	B	M	4	20	AFY	(+)COP	81529
	92	01/95 → 11/00	1.781	B	M	4	20	ADR, APT, ARG	(-)COP	81526
	92	01/95 → 11/00	1.781	B	M	4	20	ADR, APT, ARG	(+)COP	81529
1.8 T	110	01/95 → 11/00	1.781	B	M	4	20	AEB, ANB, APU, ARK, AWT	(-)COP	81526
	110	01/95 → 11/00	1.781	B	M	4	20	AEB, ANB, APU, ARK, AWT	(+)COP	81529
	132	12/97 → 11/00	1.781	B	M	4	20	AJL	(-)COP	81526
	132	12/97 → 11/00	1.781	B	M	4	20	AJL	(+)COP	81529
1.8 T quattro	110	01/95 → 11/00	1.781	B	M	4	20	AEB, ANB, APU, ARK, AWT	(-)COP	81526
	110	01/95 → 11/00	1.781	B	M	4	20	AEB, ANB, APU, ARK, AWT	(+)COP	81529
	132	12/97 → 11/00	1.781	B	M	4	20	AJL	(-)COP	81526
	132	12/97 → 11/00	1.781	B	M	4	20	AJL	(+)COP	81529
1.9 DUO	66	03/98 → 09/01	1.896		M	4	8	AHU	M: AHU, M: AHH	81528
1.9 TDI	55	12/95 → 11/00	1.896	D	M	4	8	AFF		81528
	66	01/95 → 11/00	1.896	D	M	4	8	1Z, AHH, AHU		81528
	81	10/95 → 11/00	1.896	D	M	4	8	AFN, AVG		81528
	85	03/00 → 11/00	1.896	D	M	4	8	AJM		81816
	85	03/00 → 11/00	1.896	D	M	4	8	AJM		84011
1.9 TDI quattro	81	09/96 → 11/00	1.896	D	M	4	8	AFN, AVG		81528
	85	03/00 → 11/00	1.896	D	M	4	8	AJM, ATJ		81816
	85	03/00 → 11/00	1.896	D	M	4	8	AJM, ATJ		84011

**KW**

**cm<sup>3</sup>**

**NO. OF VALVES**

**AUDI**
**A4 I, Avant**

2.4	110	07/95 → 07/97	2.393	B	M	6	12	AFM		81842
	120	08/97 → 11/00	2.393	B	M	6	30	AJG, AMM, APZ		81842
	121	03/97 → 11/00	2.393	B	M	6	30	AGA, ALF, AML, APS, ARJ		81842
2.4 quattro	120	08/97 → 11/00	2.393	B	M	6	30	APZ		81842
	121	03/97 → 11/00	2.393	B	M	6	30	AGA, ALF, AML, APS, ARJ		81842
2.5 TDI	110	09/97 → 11/00	2.496	D	M	6	24	AFB, AKN		81705
2.5 TDI quattro	110	09/97 → 11/00	2.496	D	M	6	24	AFB, AKN		81705
2.6	102	01/96 → 07/97	2.598	B	M	6	12	ACZ		81842
	110	01/95 → 11/00	2.598	B	M	6	12	ABC		81842
2.6 quattro	110	01/95 → 11/00	2.598	B	M	6	12	ABC		81842
2.7 Turbo quattro	169	02/99 → 09/00	2.671	B	M	6	30	AJK		81842
2.8	128	09/95 → 07/97	2.771	B	M	6	12	AAH		81842
	142	10/96 → 11/00	2.771	B	M	6	30	ACK, AHA, ALG, AMX, APR, AQD		81842
2.8 quattro	128	01/95 → 07/97	2.771	B	M	6	12	AAH		81842
	142	10/96 → 08/01	2.771	B	M	6	30	ACK, AHA, ALG, AMX, APR, AQD		81842
RS4 quattro	280	05/00 → 09/01	2.671	B	M	6	30	ASJ, AZR		81842
S4 quattro	195	09/97 → 09/01	2.671	B	M	6	30	AGB, AZB	01-1999 →	81842
	195	09/97 → 09/01	2.671	B	M	6	30	AGB, AZB		81842

**A4 II, Avant, Cabriolet**

1.6	75	11/00 → 12/04	1.595	B	M	4	8	ALZ		81702
1.8 T	110	11/00 → 07/02	1.781	B	M	4	20	AVJ		81703
	120	07/02 → 12/04	1.781	B	M	4	20	BFB		81703
	120	07/02 → 12/04	1.781	B	M	4	20	BFB, BKB		81703
	125	07/01 → 12/04	1.781	B	M	4	20	AMB		81703
	140	11/02 → 12/04	1.781	B	M	4	20	BEX		81703
1.8 T quattro	110	11/00 → 07/02	1.781	B	M	4	20	AVJ		81703
	120	07/02 → 12/04	1.781	B	M	4	20	BFB		81703
	125	07/01 → 12/04	1.781	B	M	4	20	AMB		81703
	140	11/02 → 12/04	1.781	B	M	4	20	BEX		81703
1.9 TDI	74	05/01 → 12/04	1.896	D	M	4	8	AVB		81816
	74	05/01 → 12/04	1.896	D	M	4	8	AVB		84011 <b>NEW</b>
	85	06/04 → 12/04	1.896	D	M	4	8	BKE		81816
	85	06/04 → 12/04	1.896	D	M	4	8	BKE		84011 <b>NEW</b>
	96	11/00 → 12/04	1.896	D	M	4	8	AVF, AWX		81816
	96	11/00 → 12/04	1.896	D	M	4	8	AVF, AWX		84011 <b>NEW</b>
1.9 TDI quattro	96	11/01 → 12/04	1.896	D	M	4	8	AVF		81816
	96	11/01 → 12/04	1.896	D	M	4	8	AVF		84011 <b>NEW</b>
2.0	96	09/04 → 12/05	1.984	B	M	4	20	ALT	M: ALT	81702
	96	11/00 → 12/04	1.984	B	M	4	20	ALT		81702
2.0 FSI	110	07/02 → 12/04	1.984	B	M	4	16	AWA		81702





KW



cm<sup>3</sup>



NO. OF VALVES



**AUDI**

**A4 II, Avant, Cabriolet**

2.0 TDI	100	01/06 → 03/09	1.968	D	M	4	8	BRC		81816
	100	01/06 → 03/09	1.968	D	M	4	8	BRC		84011 <b>NEW</b>
	103	01/06 → 03/09	1.968	D	M	4	8	BPW		81816
	103	01/06 → 03/09	1.968	D	M	4	8	BPW		84011 <b>NEW</b>
2.0 TFSI 16V	147	01/06 → 03/09	1.984	B	M	4	16	BWE, BWT		82025
2.0 TFSI quattro	147	11/05 → 03/09	1.984	B	M	4	16	BWT		82025
2.4	120	09/01 → 12/04	2.393	B	M	6	30	AMM		81842
	125	09/01 → 12/04	2.393	B	M	6	30	BDV		81842
2.5 TDI	114	08/01 → 07/02	2.496	D	M	6	24	AYM		81705
	120	07/02 → 12/04	2.496	D	M	6	24	BCZ, BDG, BFC		81705
	132	10/00 → 05/03	2.496	D	M	6	24	AKE		81705
2.5 TDI quattro	132	11/00 → 12/04	2.496	D	M	6	24	AKE, BAU, BDH		81705
2.7 TDI	132	06/06 → 03/09	2.698	D	M	6	24	BPP		82015
3.0	160	04/01 → 12/04	2.976	B	M	6	30	BBJ		81819
	162	09/01 → 12/04	2.976	B	M	6	30	ASN		81819
	162	11/00 → 12/04	2.976	B	M	6	30	ASN, AVK		81819
3.0 quattro	160	04/01 → 12/04	2.976	B	M	6	30	BBJ		81819
	162	05/03 → 12/05	2.976	B	M	6	30	ASN		81819
	162	09/01 → 12/04	2.976	B	AM	6	30	ASN, AVK		81819
	162	11/00 → 12/04	2.976	B	M	6	30	ASN, AVK		81819
3.0 TDI quattro	150	01/06 → 03/09	2.967	D	M	6	24	BKN		82015
	171	01/06 → 03/09	2.967	D	M	6	24	ASB		82015
3.2 FSI	188	01/06 → 03/09	3.123	B	M	6	24	AUK		82015
3.2 FSI quattro	188	01/06 → 03/09	3.123	B	M	6	24	AUK		82015
S4 quattro	253	03/03 → 12/04	4.163	B	M	8	40	BBK		82046

**A4 III, Avant**

1.6	75	11/04 → 06/08	1.595	B	M	4	8	ALZ		81702
1.8 T	120	11/04 → 06/08	1.781	B	M	4	20	BFB		81703
1.8 T quattro	120	11/04 → 06/08	1.781	B	M	4	20	BFB		81703
1.9 TDI	85	11/04 → 06/08	1.896	D	M	4	8	BKE, BRB		81816
	85	11/04 → 06/08	1.896	D	M	4	8	BKE, BRB		84011 <b>NEW</b>
2.0	96	11/04 → 06/08	1.984	B	M	4	20	ALT		81702
2.0 TDI	89	09/05 → 09/06	1.968	D	M	4	16	BVG		81816
	89	09/05 → 09/06	1.968	D	M	4	16	BVG		84011 <b>NEW</b>
	93	11/05 → 11/06	1.968	D	M	4	16	BVF		81816
	93	11/05 → 11/06	1.968	D	M	4	16	BVF		84011 <b>NEW</b>
	100	11/04 → 06/08	1.968	D	M	4	16	BNA, BRF		81816
	100	11/04 → 06/08	1.968	D	M	4	16	BNA, BRF		84011 <b>NEW</b>
	103	11/04 → 06/08	1.968	D	M	4	8	BPW		81816
	103	11/04 → 06/08	1.968	D	M	4	8	BPW		84011 <b>NEW</b>
	120	06/06 → 06/08	1.968	D	M	4	16	BVA		81816
	120	06/06 → 06/08	1.968	D	M	4	16	BVA		84011 <b>NEW</b>
	125	06/06 → 06/08	1.968	D	M	4	16	BRD		81816
	125	06/06 → 06/08	1.968	D	M	4	16	BRD		84011 <b>NEW</b>

**KW**

**cm<sup>3</sup>**

**NO. OF VALVES**

**MAGNETI MARELLI**
**AUDI**
**A4 III, Avant**

2.0 TDI 16V	103	11/04 → 06/08	1.968	D	M	4	16	BLB, BRE		81816	
	103	11/04 → 06/08	1.968	D	M	4	16	BLB, BRE		84011	<b>NEW</b>
2.0 TDI quattro	103	01/06 → 06/08	1.968	D	M	4	8	BPW		81816	
	103	01/06 → 06/08	1.968	D	M	4	8	BPW		84011	<b>NEW</b>
	120	06/06 → 06/08	1.968	D	M	4	16	BVA		81816	
	120	06/06 → 06/08	1.968	D	M	4	16	BVA		84011	<b>NEW</b>
	125	06/06 → 06/08	1.968	D	M	4	16	BRD		81816	
	125	06/06 → 06/08	1.968	D	M	4	16	BRD		84011	<b>NEW</b>
2.0 TFSI	125	10/06 → 06/08	1.984	B	M	4	16	BPJ, BYK		82025	
	147	11/04 → 06/08	1.984	B	M	4	16	BGB, BPG, BWE, BWT		82025	
	147	11/04 → 06/08	1.984	B	M	4	16	BGB, BWE		82025	
	162	06/05 → 06/08	1.984	B	M	4	16	BUL		82025	
2.0 TFSI quattro	147	11/04 → 06/08	1.984	B	M	4	16	BGB, BPG, BWE, BWT		82025	
	147	11/04 → 06/08	1.984	B	M	4	16	BGB, BWE, BWT		82025	
	162	06/05 → 06/08	1.984	B	M	4	16	BUL		82025	
2.5 TDI	120	11/04 → 05/06	2.496	D	M	6	24	BDG		81705	
2.7 TDI	120	11/05 → 06/08	2.698	D	M	6	24	BSG		82015	
	132	01/06 → 06/08	2.698	D	M	6	24	BPP		82015	
3.0	160	11/04 → 05/06	2.976	B	M	6	30	BBJ		81819	
3.0 quattro	160	11/04 → 07/06	2.976	B	M	6	30	BBJ		81819	
3.0 TDI quattro	150	11/04 → 06/08	2.967	D	M	6	24	BKN		82015	
	171	01/06 → 06/08	2.967	D	M	6	24	ASB		82015	
3.2 FSI	188	01/05 → 06/08	3.123	B	M	6	24	AUK		82015	
3.2 FSI quattro	188	01/05 → 06/08	3.123	B	M	6	24	AUK		82015	
	188	01/05 → 06/08	3.123	B	M	6	24	AUK, BKH		82015	
S4 quattro	253	11/04 → 06/08	4.163	B	M	8	40	BBK		82046	
	253	11/04 → 06/08	4.163	B	M	8	40	BBK, BHF		82046	

**A4 IV, Avant, Allroad**

1.8 TFSI	88	01/08 → 12/15	1.798	B	M	4	16	CABA, CDHA		84016	<b>NEW</b>
	88	04/08 → 12/15	1.798	B	M	4	16	CDHA		84016	<b>NEW</b>
	118	11/07 → 03/12	1.798	B	M	4	16	CABB, CCUA, CDHB		84016	<b>NEW</b>
	125	11/11 → 12/15	1.798	B	M	4	16	CJEB		84037	<b>NEW</b>
1.8 TFSI quattro	118	09/08 → 03/12	1.798	B	M	4	16	CDHB		84016	<b>NEW</b>
	125	11/11 → 12/15	1.798	B	M	4	16	CJEB		84037	<b>NEW</b>

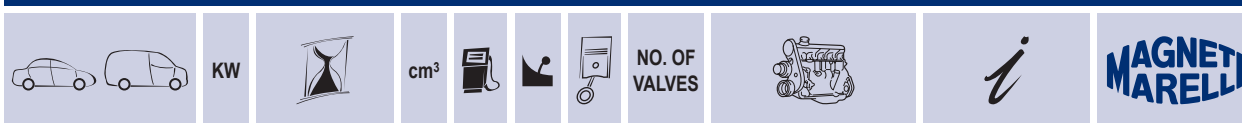

## AUDI

### A4 IV, Avant, Allroad

2.0 TDI	88	06/08 → 12/15	1.968	D	M	4	16	CAGC, CJCC		81816
	88	06/08 → 12/15	1.968	D	M	4	16	CAGC, CJCC		84011 <b>NEW</b>
	100	11/07 → 12/15	1.968	D	M	4	16	CAGB, CJCB, CSUB		81816
	100	11/07 → 12/15	1.968	D	M	4	16	CAGB, CJCB, CSUB		84011 <b>NEW</b>
	105	11/07 → 12/15	1.968	D	M	4	16	CAGA, CJCA, CMEA, CMFA		81816
	105	11/07 → 12/15	1.968	D	M	4	16	CAGA, CJCA, CMEA, CMFA		84011 <b>NEW</b>
	110	05/13 → 12/15	1.968	D	M	4	16	CJCD, CMFB, CSUA		84001
	120	08/08 → 12/15	1.968	D	M	4	16	CAHB, CGLD, CNHC		81816
	120	08/08 → 12/15	1.968	D	M	4	16	CAHB, CGLD, CNHC		84011 <b>NEW</b>
	125	01/08 → 03/12	1.968	D	M	4	16	CAHA		81816
	125	01/08 → 03/12	1.968	D	M	4	16	CAHA		84011 <b>NEW</b>
	130	11/11 → 12/15	1.968	D	M	4	16	CGLC		84001
130	11/11 → 12/15	1.968	D	M	4	16	CGLC, CMGB		84001	
2.0 TDI quattro	100	09/09 →	1.968	D	M	4	16	CAGB, CJCB, CSUB		81816
	100	09/09 →	1.968	D	M	4	16	CAGB, CJCB, CSUB		84011 <b>NEW</b>
	105	11/08 → 12/15	1.968	D	M	4	16	CAGA, CJCA		81816
	105	11/08 → 12/15	1.968	D	M	4	16	CAGA, CJCA		84011 <b>NEW</b>
	120	04/09 →	1.968	D	M	4	16	CAHB, CGLD, CNHC		81816
	120	04/09 →	1.968	D	M	4	16	CAHB, CGLD, CNHC		84011 <b>NEW</b>
	125	01/08 → 03/12	1.968	D	M	4	16	CAHA		81816
	125	01/08 → 03/12	1.968	D	M	4	16	CAHA		84011 <b>NEW</b>
2.0 TFSI	132	11/11 → 12/15	1.968	D	M	4	16	CGLC		84001
	132	06/08 → 12/15	1.984	B	M	4	16	CAEA, CDN, CFKA		84016 <b>NEW</b>
	155	06/08 → 05/13	1.984	B	M	4	16	CAEB, CDNC		84016 <b>NEW</b>
2.0 TFSI flexible fuel	165	05/13 → 12/15	1.984	B	M	4	16	CNCD		84037 <b>NEW</b>
2.0 TFSI flexible fuel quattro	132	11/09 → 12/15	1.984		M	4	16	CFKA		84016 <b>NEW</b>
2.0 TFSI quattro	155	06/08 → 12/15	1.984	B	M	4	16	CAEB, CDNC		84016 <b>NEW</b>
	155	06/08 → 12/15	1.984	B	M	4	16	CAEB, CDNC, CPMA		84016 <b>NEW</b>
	155	04/09 →	1.984	B	M	4	16	CDNC, CPMA		84016 <b>NEW</b>
	162	05/13 → 12/15	1.984	B	M	4	16	CAED, CPMB		84016 <b>NEW</b>
	162	05/13 →	1.984	B	M	4	16	CPMB		84016 <b>NEW</b>
	165	05/13 → 12/15	1.984	B	M	4	16	CNCD		84037 <b>NEW</b>
2.7 TDI	120	11/07 → 03/12	2.698	D	M	6	24	CAMB, CGKB		82015
	140	11/07 → 03/12	2.698	D	M	6	24	CAMA, CGKA		82015
3.0 TDI	150	11/11 → 12/15	2.967	D	M	6	24	CLAB		84021 <b>NEW</b>
3.0 TDI quattro	155	06/08 → 05/10	2.967	D	M	6	24	CCWB		82015
	176	11/07 → 03/12	2.967	D	M	6	24	CAPA, CCLA, CCWA		82015
	176	04/09 →	2.967	D	M	6	24	CCWA		82015
	180	11/11 → 12/15	2.967	D	M	6	24	CDUC, CKVB, CKVC		84021 <b>NEW</b>

**KW**

**cm<sup>3</sup>**

**NO. OF VALVES**

**MAGNETI MARELLI**
**AUDI**
**A4 IV, Avant, Allroad**

S4 quattro	245	11/08 → 12/15	2.995	B	M	6	24	CAKA, CCBA, CGWC, CGXC, CREC, CTUB		82015	
------------	-----	---------------	-------	---	---	---	----	------------------------------------	--	-------	--

**A4 V, Avant, Allroad**

1.4 TFSI	110	08/15 →	1.395	B	M	4	16	CVNA		84062	<b>NEW</b>
2.0 TFSI	140	05/15 →	1.984	B	M	4	16	CVKB		84037	<b>NEW</b>
	183	11/15 →	1.984	B	M	4	16	CYRC		84037	<b>NEW</b>
	185	05/15 →	1.984	B	M	4	16	CYMC, CYRB		84037	<b>NEW</b>
2.0 TFSI quattro	183	11/15 →	1.984	B	M	4	16	CYRC		84037	<b>NEW</b>
	185	05/15 →	1.984	B	M	4	16	CYMC, CYRB		84037	<b>NEW</b>
	185	08/15 →	1.984	B	M	4	16	CYRB		84037	<b>NEW</b>

**A5, Sportback, Cabriolet**

1.8 TFSI	106	09/14 →	1.798	B	M	4	16	CJED		84037	<b>NEW</b>
	118	05/09 →	1.798	B	M	4	16	CDHB		84016	<b>NEW</b>
	125	10/07 →	1.798	B	M	4	16	CABD, CJEB		84016	<b>NEW</b>
	125	10/11 →	1.798	B	M	4	16	CABD, CJEB		84037	<b>NEW</b>
	125	08/11 →	1.798	B	M	4	16	CJEB		84037	<b>NEW</b>
	130	05/15 →	1.798	B	M	4	16	CJEE		84037	<b>NEW</b>
2.0 TDI	100	09/09 →	1.968	D	M	4	16	CAGB, CJCB		81816	
	100	09/09 →	1.968	D	M	4	16	CAGB, CJCB		84011	<b>NEW</b>
	105	09/09 →	1.968	D	M	4	16	CAGA, CJCA, CMEA, CMFA		81816	
	105	09/09 →	1.968	D	M	4	16	CAGA, CJCA, CMEA, CMFA		84011	<b>NEW</b>
	105	10/11 →	1.968	D	M	4	16	CJCA		84001	
	110	05/13 →	1.968	D	M	4	16	CJCD		84001	
	120	08/08 →	1.968	D	M	4	16	CAHB, CGLD		81816	
	120	08/08 →	1.968	D	M	4	16	CAHB, CGLD		84011	<b>NEW</b>
	125	08/08 →	1.968	D	M	4	16	CAHA		81816	
	125	08/08 →	1.968	D	M	4	16	CAHA		84011	<b>NEW</b>
2.0 TDI quattro	130	10/11 →	1.968	D	M	4	16	CGLC		84001	
	125	08/08 →	1.968	D	M	4	16	CAHA		81816	
	125	08/08 →	1.968	D	M	4	16	CAHA		84011	<b>NEW</b>
2.0 TFSI	132	03/09 →	1.984	B	M	4	16	CAEA, CDNB		84016	<b>NEW</b>
	132	11/08 →	1.984	B	M	4	16	CDNB		84016	<b>NEW</b>
	155	03/09 →	1.984	B	M	4	16	CAEB, CDNC	→ 07-2011	84016	<b>NEW</b>
	155	03/09 →	1.984	B	M	4	16	CAEB, CDNC	08-2011 →	84037	<b>NEW</b>
	155	06/08 →	1.984	B	M	4	16	CDNC	→ 07-2011	84016	<b>NEW</b>
	155	06/08 →	1.984	B	M	4	16	CDNC	08-2011 →	84037	<b>NEW</b>
	162	05/13 →	1.984	B	M	4	16	CAED		84016	<b>NEW</b>
	165	05/13 →	1.984	B	M	4	16	CNCD		84016	<b>NEW</b>
	169	08/15 →	1.984	B	M	4	16	CNCE		84037	<b>NEW</b>

**KW**

**cm<sup>3</sup>**

**NO. OF VALVES**

**MAGNETI MARELLI**
**AUDI**
**A5, Sportback, Cabriolet**

2.0 TFSI quattro	155	06/08 →	1.984	B	M	4	16	CAEB, CDNC	→ 07-2011	84016	<b>NEW</b>
	155	06/08 →	1.984	B	M	4	16	CAEB, CDNC	08-2011 →	84037	<b>NEW</b>
	155	09/09 →	1.984	B	M	4	16	CDNC	→ 07-2011	84016	<b>NEW</b>
	155	09/09 →	1.984	B	M	4	16	CDNC	08-2011 →	84037	<b>NEW</b>
	162	03/12 →	1.984	B	M	4	16	CAED, CPMB		84016	<b>NEW</b>
	165	05/13 →	1.984	B	M	4	16	CNCD		84016	<b>NEW</b>
	169	08/15 →	1.984	B	M	4	16	CNCE		84037	<b>NEW</b>
2.7 TDI	120	09/07 →	2.698	D	M	6	24	CAMB, CGKB		82015	
	120	05/09 →	2.698	D	M	6	24	CGKB		82015	
	140	06/07 →	2.698	D	M	6	24	CAMA, CGKA		82015	
	140	03/09 →	2.698	D	M	6	24	CGKA		82015	
3.0 TDI	150	10/11 →	2.967	D	M	6	24	CLAB		84021	<b>NEW</b>
3.0 TDI quattro	155	03/08 →	2.967	D	M	6	24	CCWB		82015	
	176	06/07 →	2.967	D	M	6	24	CAPA, CCWA		82015	
	176	03/09 →	2.967	D	M	6	24	CCWA		82015	
	180	10/11 →	2.967	D	M	6	24	CDUC, CKVB, CKVC		84021	<b>NEW</b>
	180	10/11 →	2.967	D	M	6	24	CDUC, CKVC		84021	<b>NEW</b>
S5 quattro	245	06/09 →	2.995	B	M	6	24	CAKA, CCBA, CGWC, CGXC, CREC, CTDA, CTUB		82015	
	245	10/11 →	2.995	B	M	6	24	CAKA, CGWC, CGXC, CREC, CTDA, CTUB		82015	

**A6 I, Avant**

1.8	92	12/95 → 10/97	1.781	B	M	4	20	ADR	(-)COP	81526	
	92	12/95 → 10/97	1.781	B	M	4	20	ADR	(+)COP	81529	
1.8 quattro	92	12/95 → 10/97	1.781	B	M	4	20	ADR	(-)COP	81526	
	92	12/95 → 10/97	1.781	B	M	4	20	ADR	(+)COP	81529	
1.9 TDI	66	06/94 → 10/97	1.896	D	M	4	8	1Z, AHU	(-)COP, M: 1Z	81522	
	66	06/94 → 10/97	1.896	D	M	4	8	1Z, AHU	(+)COP	82080	
	66	06/94 → 10/97	1.896	D	M	4	8	1Z, AHU	(+)COP, M: 1Z	82080	
	66	06/94 → 10/97	1.896	D	M	4	8	1Z, AHU	M: AHU	81528	
2.0	74	06/94 → 10/97	1.984	B	M	4	8	AAE	(-)COP	81522	
	74	06/94 → 10/97	1.984	B	M	4	8	AAE	(+)COP	82080	
	79	08/95 → 07/96	1.984	B	M	4	8	ADW	(-)COP	81522	
	79	08/95 → 07/96	1.984	B	M	4	8	ADW	(+)COP	82080	
	85	06/94 → 10/97	1.984	B	M	4	8	ABK	(-)COP	81522	
	85	06/94 → 10/97	1.984	B	M	4	8	ABK	(+)COP	82080	
2.0 16V	103	06/94 → 10/97	1.984	B	M	4	16	ACE	(-)COP	81522	
	103	06/94 → 10/97	1.984	B	M	4	16	ACE	(+)COP	82080	
2.0 16V quattro	103	06/94 → 10/97	1.984	B	M	4	16	ACE	(-)COP	81522	
	103	06/94 → 10/97	1.984	B	M	4	16	ACE	(+)COP	82080	
2.3	98	06/94 → 12/95	2.309	B	M	5	10	AAR		81700	
2.3 quattro	98	06/94 → 12/95	2.309	B	M	5	10	AAR		81700	
2.4	110	07/95 → 06/96	2.393	B	M	6	12	AFM		81842	

**KW**

**cm<sup>3</sup>**

**NO. OF VALVES**

**AUDI**
**A6 I, Avant**

2.5 TDI	84	01/95 → 10/97	2.461	D	M	5	10	AAT		81701
	85	06/94 → 10/97	2.461	D	M	5	10	AAT		81701
	103	08/94 → 10/97	2.461	D	M	5	10	AEL		81701
2.5 TDI quattro	103	10/95 → 10/97	2.461	D	M	5	10	AEL		81701
2.6	102	06/94 → 02/97	2.598	B	M	6	12	ACZ	(+)COP, 08-1996 →, → 02-1997, T →: F44-S-026.715	81529
	102	06/94 → 10/97	2.598	B	M	6	12	ACZ	08-1996 →, → 02-1997, T →: F44-S-026-715	81842
	110	06/94 → 10/97	2.598	B	M	6	12	ABC	08-1996 →, → 02-1997, T →: F44-S-026-715	81842
	110	06/94 → 12/97	2.598	B	M	6	12	ABC	08-1996 →, → 12-1997, T →: F44-S-026.715	81842
2.6 quattro	110	06/94 → 10/97	2.598	B	M	6	12	ABC	08-1996 →, → 02-1997, T →: F44-S-026-715	81842
	110	06/94 → 12/97	2.598	B	M	6	12	ABC	08-1996 →, → 12-1997, T →: F44-S-026.715	81842
2.8	128	06/94 → 12/97	2.771	B	M	6	12	AAH, AEJ	08-1996 →, → 12-1997, T →: F44-S-026.715	81842
	128	06/94 → 10/97	2.771	B	M	6	12	AAH, AEJ, AFC	08-1996 →, → 02-1997, T →: F44-S-026.715	81842
	142	12/95 → 10/97	2.771	B	M	6	30	ACK	T →: F44-S-026.715	81842
2.8 quattro	128	06/94 → 10/97	2.771	B	M	6	12	AAH, AEJ	08-1996 →, → 02-1997, T →: F44-S-026.715	81842
	128	06/94 → 12/97	2.771	B	M	6	12	AAH, AEJ	08-1996 →, → 12-1997, T →: F44-S-026.715	81842
	142	12/95 → 10/97	2.771	B	M	6	30	ACK		81842
	142	12/95 → 12/97	2.771	B	M	6	30	ACK	T →: F44-S-026.715	81842
S6 Turbo quattro	169	06/94 → 10/97	2.226	B	M	5	20	AAN		81700
<b>A6 II, Avant</b>										
	85	05/97 → 01/05	1.781	B	M	4	20	AFY	(-)COP	81526
	85	05/97 → 01/05	1.781	B	M	4	20	AFY	(+)COP	81529
	92	07/97 → 01/05	1.781	B	M	4	20	AJP, ANQ, AQE, ARH		81702
	92	12/97 → 01/05	1.781	B	M	4	20	AJP, AQE, ARH		81702

--	--	--	--	--	--	--	--	--	--

**AUDI**
**A6 II, Avant**

1.8 T	110	01/97 → 01/05	1.781	B	M	4	20	AEB, ANB, APU, ARK, AWL, AWT	(-)COP, NOT FOR: M AWT	81526
	110	01/97 → 01/05	1.781	B	M	4	20	AEB, ANB, APU, ARK, AWL, AWT	(+)COP, NOT FOR: M AWT	81529
	110	01/97 → 01/05	1.781	B	M	4	20	AEB, ANB, APU, ARK, AWL, AWT	05-2000 →, → 07-2004, M: AWT	81703
	110	12/97 → 01/05	1.781	B	M	4	20	AEB, ANB, APU, ARK, AWT	(-)COP, NOT FOR: M AWT	81526
	110	12/97 → 01/05	1.781	B	M	4	20	AEB, ANB, APU, ARK, AWT	(+)COP, NOT FOR: M AWT	81529
	110	12/97 → 01/05	1.781	B	M	4	20	AEB, ANB, APU, ARK, AWT	02-2000 →, → 07-2004, M: AWT	81703
	132	12/97 → 01/05	1.781	B	M	4	20	AJL	(-)COP	81526
	132	12/97 → 01/05	1.781	B	M	4	20	AJL	(+)COP	81529
1.8 T quattro	110	02/97 → 01/05	1.781	B	M	4	20	AEB, ANB, APU, ARK, AWT	(-)COP, NOT FOR: M AWT	81526
	110	02/97 → 01/05	1.781	B	M	4	20	AEB, ANB, APU, ARK, AWT	(+)COP, NOT FOR: M AWT	81529
	110	02/97 → 01/05	1.781	B	M	4	20	AEB, ANB, APU, ARK, AWT	05-2000 →, → 07-2004, M: AWT	81703
	132	12/97 → 01/05	1.781	B	M	4	20	AJL	(-)COP	81526
	132	12/97 → 01/05	1.781	B	M	4	20	AJL	(+)COP	81529
1.9 TDI	81	04/97 → 10/00	1.896	D	M	4	8	AFN, AVG		81528
	85	07/00 → 01/05	1.896	D	M	4	8	AJM		81816
	85	07/00 → 01/05	1.896	D	M	4	8	AJM		84011
	96	08/01 → 01/05	1.896	D	M	4	8	AVF, AWX		81816
	96	08/01 → 01/05	1.896	D	M	4	8	AVF, AWX		84011
2.0	96	08/01 → 01/05	1.984	B	M	4	20	ALT		81702
2.4	100	07/98 → 01/05	2.393	B	M	6	30	ALW, ARN, ASM		81842
	115	02/97 → 01/05	2.393	B	M	6	30	APC		81842
	120	02/97 → 01/05	2.393	B	M	6	30	AJG, AMM, APZ		81842
	121	02/97 → 01/05	2.393	B	M	6	30	AGA, ALF, AML, APS, ARJ		81842
	121	12/97 → 01/05	2.393	B	M	6	30	AGA, ALF, AML, APS, ARJ	T →: F44-S-026.715	81842
	125	08/01 → 01/05	2.393	B	AM	6	30	BDV		81842
2.4 quattro	115	08/98 → 07/99	2.393	B	M	6	30	APC		81842
	120	02/97 → 01/05	2.393	B	M	6	30	AJG, APZ		81842
	121	02/97 → 01/05	2.393	B	M	6	30	AGA, ALF, AML, APS, ARJ		81842
	121	12/97 → 01/05	2.393	B	M	6	30	AGA, ALF, AML, APS, ARJ	T →: F44-S-026.715	81842
	125	08/01 → 01/05	2.393	B	AM	6	30	BDV		81842

**KW**

**cm<sup>3</sup>**

**NO. OF VALVES**

**MAGNETI MARELLI**
**AUDI**
**A6 II, Avant**

2.5 TDI	110	07/97 → 01/05	2.496	D	M	6	24	AFB, AKN		81705
	114	08/01 → 01/05	2.496	D	M	6	24	AYM		81705
	120	07/02 → 01/05	2.496	D	M	6	24	BCZ, BDG, BFC		81705
	132	02/00 → 01/05	2.496	D	M	6	24	AKE, BAU, BDH		81705
	132	02/00 → 01/05	2.496	D	M	6	24	AKE, BAU, BDH, BND		81705
2.5 TDI quattro	110	07/97 → 01/05	2.496	D	M	6	24	AFB, AKN		81705
	132	02/00 → 01/05	2.496	D	M	6	24	AKE, BAU, BDH		81705
2.7	187	05/01 → 07/04	2.671	B	M	6	30	APB, BEL		81842
2.7 quattro	187	05/01 → 07/04	2.671	B	M	6	30	APB, BEL		81842
	195	11/03 → 07/04	2.671	B	M	6	30	BEL		81842
2.7 T	169	02/99 → 01/05	2.671	B	M	6	30	AJK	T →: F44-S-026.715	81842
	169	02/99 → 01/05	2.671	B	M	6	30	AJK		81842
2.7 T quattro	169	12/97 → 01/05	2.671	B	M	6	30	AJK, AZA	01-1999 →	81842
	169	12/97 → 01/05	2.671	B	M	6	30	AJK, AZA	T →: F44-S-026.715	81842
	169	12/97 → 01/05	2.671	B	M	6	30	AJK, AZA		81842
	184	08/01 → 01/05	2.671	B	M	6	30	ARE, BES		81842
2.8	132	10/97 → 05/00	2.771	B	M	6	30	AGE		81842
	140	07/99 → 01/05	2.771	B	M	6	30	ATX		81842
	140	07/99 → 01/05	2.771	B	M	6	30	ATX, BBG		81842
	142	02/97 → 01/05	2.771	B	M	6	30	ACK, AHA, ALG, AMX, APR, AQD	T →: F44-S-026.715	81842
	142	02/97 → 01/05	2.771	B	M	6	30	ACK, AHA, ALG, AMX, APR, AQD		81842
2.8 quattro	132	01/98 → 04/00	2.771	B	M	6	30	AGE		81842
	140	07/99 → 05/01	2.771	B	M	6	30	ATX		81842
	142	02/97 → 01/05	2.771	B	M	6	30	ACK, AHA, ALG, AMX, APR, AQD	T →: F44-S-026.715	81842
	142	02/97 → 01/05	2.771	B	M	6	30	ACK, AHA, ALG, AMX, APR, AQD		81842
3.0	162	08/01 → 01/05	2.976	B	M	6	30	ASN		81819
3.0 quattro	160	06/01 → 07/04	2.976	B	M	6	30	BBJ		81819
	162	08/01 → 01/05	2.976	B	M	6	30	ASN		81819
3.7	191	03/99 → 01/05	3.697	B	A	8	40	AQG		82081
3.7 quattro	191	03/99 → 01/05	3.697	B	A	8	40	AQG		82081
4.2 quattro	220	11/98 → 01/05	4.172	B	M	8	40	ARS, ASG, AWN	04-1999 →	82081
	220	11/98 → 01/05	4.172	B	M	8	40	ARS, ASG, AWN		82081
RS6 plus quattro	353	04/04 → 01/05	4.172	B	M	8	40	BRV		82081
RS6 quattro	331	07/02 → 01/05	4.172	B	M	8	40	BCY		82081
S6 quattro	250	09/99 → 01/05	4.172	B	M	8	40	ANK, AQJ	04-1999 →	82081
	250	09/99 → 01/05	4.172	B	M	8	40	ANK, AQJ		82081



**KW**

**cm<sup>3</sup>**

**NO. OF VALVES**

**MAGNETI MARELLI**
**AUDI**
**A6 III, Avant, Allroad**

2.0 TDI	89	09/05 → 06/06	1.968	D	M	4	16	BVG		81816	
	89	09/05 → 06/06	1.968	D	M	4	16	BVG		84011	<b>NEW</b>
	100	07/04 → 03/11	1.968	D	M	4	16	BNA, BRF, CAGB		81816	
	100	07/04 → 03/11	1.968	D	M	4	16	BNA, BRF, CAGB		84011	<b>NEW</b>
	103	07/04 → 10/08	1.968	D	M	4	16	BLB, BRE		81816	
	103	07/04 → 10/08	1.968	D	M	4	16	BLB, BRE		84011	<b>NEW</b>
	120	04/09 → 03/11	1.968	D	M	4	16	CAHB		81816	
	120	04/09 → 03/11	1.968	D	M	4	16	CAHB		84011	<b>NEW</b>
	125	11/08 → 03/11	1.968	D	M	4	16	CAHA		81816	
125	11/08 → 03/11	1.968	D	M	4	16	CAHA		84011	<b>NEW</b>	
2.0 TFSI	125	06/05 → 08/11	1.984	B	M	4	16	BPJ		82025	
	125	06/05 → 03/11	1.984	B	M	4	16	BPJ, BYK		82025	
2.4	130	05/04 → 10/08	2.393	B	M	6	24	BDW		82015	
2.4 quattro	130	01/05 → 10/08	2.393	B	M	6	24	BDW		82015	
2.7 TDI	120	11/04 → 03/11	2.698	D	M	6	24	BSG, CANB		82015	
	132	11/04 → 10/08	2.698	D	M	6	24	BPP		82015	
	140	10/08 → 03/11	2.698	D	M	6	24	CANA		82015	
2.7 TDI quattro	120	06/05 → 03/11	2.698	D	M	6	24	BSG, CAND		82015	
	132	11/04 → 10/08	2.698	D	M	6	24	BPP		82015	
	140	10/08 → 03/11	2.698	D	M	6	24	CANC		82015	
3.0	160	08/04 → 05/06	2.976	B	M	6	30	BBJ		81819	
3.0 quattro	160	05/04 → 05/06	2.976	B	M	6	30	BBJ		81819	
3.0 TDI	171	06/06 → 03/11	2.967	D	M	6	24	ASB		82015	
3.0 TDI quattro	155	05/04 → 03/11	2.967	D	M	6	24	BNG, CDYB		82015	
	165	05/04 → 05/06	2.967	D	M	6	24	BMK		82015	
	171	06/06 → 10/08	2.967	D	M	6	24	ASB		82015	
	176	10/08 → 03/11	2.967	D	M	6	24	CDYA, CDYC		82015	
3.0 TFSI quattro	213	10/08 → 03/11	2.995	B	M	6	24	CAJA	→ 02-2009	82015	
	213	10/08 → 08/11	2.995	B	M	6	24	CAJA		82015	
	220	10/08 → 03/11	2.995	B	M	6	24	CCAA		82015	
3.2 FSI	188	03/05 → 10/08	3.123	B	M	6	24	AUK		82015	
	188	05/04 → 05/09	3.123	B	M	6	24	AUK, BKH		82015	
	195	05/09 → 03/11	3.197	B	M	6	24	CALA		82015	
3.2 FSI quattro	183	09/06 → 10/08	3.123	B	M	6	24	BYU		82015	
	188	05/06 → 10/08	3.123	B	M	6	24	AUK		82015	
	188	05/04 → 10/08	3.123	B	M	6	24	AUK, BKH		82015	
4.2 quattro	246	05/04 → 05/06	4.163	B	M	8	40	BAT		82046	
<b>A6 IV, Avant, Allroad</b>											
1.8 TFSI	140	09/14 →	1.798	B	M	4	16	CYGA		84037	<b>NEW</b>
2.0 TDI	100	01/12 →	1.968	D	M	4	16	CGLG, CSUE		84001	
	120	03/11 →	1.968	D	M	4	16	CGLD		84001	
	130	03/11 →	1.968	D	M	4	16	CGLC, CMGB		84001	

**KW**

**cm<sup>3</sup>**

**NO. OF VALVES**

**MAGNETI MARELLI**
**AUDI**
**A6 IV, Avant, Allroad**

2.0 TFSI	132	05/11 →	1.984	B	M	4	16	CDNB		84016	<b>NEW</b>
	155	03/11 → 05/13	1.984	B	M	4	16	CAEB		84016	<b>NEW</b>
	185	09/14 →	1.984	B	M	4	16	CYNB, CYPA		84037	<b>NEW</b>
2.0 TFSI hybrid	155	11/11 →	1.984		M	4	16	CHJA		84016	<b>NEW</b>
2.0 TFSI quattro	183	05/15 →	1.984	B	M	4	16	CYPB		84037	<b>NEW</b>
	185	05/14 →	1.984	B	M	4	16	CYNB, CYPA		84037	<b>NEW</b>
	185	05/15 →	1.984	B	M	4	16	CYPA		84037	<b>NEW</b>
3.0 TDI	150	11/10 →	2.967	D	M	6	24	CLAB		84021	<b>NEW</b>
3.0 TDI quattro	150	03/11 →	2.967	D	M	6	24	CLAA		84021	<b>NEW</b>

**A7**

1.8 TFSI	140	04/15 →	1.798	B	M	4	16	CYGA		84037	<b>NEW</b>
2.0 TFSI	185	09/14 →	1.984	B	M	4	16	CYPA		84037	<b>NEW</b>
2.0 TFSI quattro	183	05/15 →	1.984	B	M	4	16	CYPB		84037	<b>NEW</b>
	185	05/15 →	1.984	B	M	4	16	CYNB, CYPA		84037	<b>NEW</b>
3.0 TDI	150	11/10 →	2.967	D	M	6	24	CLAB		84021	<b>NEW</b>
3.0 TDI quattro	150	12/10 →	2.967	D	M	6	24	CLAA		84021	<b>NEW</b>
	180	10/10 →	2.967	D	M	6	24	CDUC, CDUD, CKVB, CKVC	M: CDUD, M: CDUC	84021	<b>NEW</b>

**A8 I**

2.5 TDI	110	01/97 → 04/00	2.496	D	M	6	24	AFB, AKN		81705	
	132	09/00 → 09/02	2.496	D	M	6	24	AKE		81705	
2.5 TDI quattro	110	07/97 → 04/00	2.496	D	M	6	24	AFB, AKN		81705	
	132	09/00 → 09/02	2.496	D	M	6	24	AKE		81705	
2.8	142	04/96 → 09/02	2.771	B	M	6	30	ACK, ALG, AMX, APR, AQD	T →: F4D-S-000.497	81842	
2.8 quattro	142	04/96 → 09/02	2.771	B	M	6	30	ACK, AMX, APR, AQD	T →: F4D-S-000.497	81842	
3.3 TDI quattro	165	06/00 → 09/02	3.328	D	M	8	40	AKF		82041	
3.7	191	11/98 → 09/02	3.697	B	A	8	40	AKC, AQQ		82081	
3.7 quattro	191	11/98 → 09/02	3.697	B	A	8	40	AKC, AQQ		82081	
4.2 quattro	175	02/99 → 04/00	4.172	B	M	8	32	ARU		82081	
	228	11/98 → 09/02	4.172	B	M	8	40	AQF, AUW, AUX		82081	
S 8 quattro	265	06/99 → 09/02	4.172	B	A	8	40	AQH, AVP		82081	

**A8 II**

3.0	160	07/03 → 05/06	2.976	B	M	6	30	BBJ		81819	
	162	07/03 → 05/05	2.976	B	M	6	30	ASN		81819	
3.0 quattro	160	11/03 → 05/04	2.976	B	M	6	30	BBJ		81819	
3.0 TDI quattro	155	11/03 → 07/10	2.967	D	M	6	24	BNG		82015	
	171	08/03 → 07/10	2.967	D	M	6	24	ASB		82015	
3.2 FSI	191	06/05 → 07/10	3.123	B	M	6	24	BPK		82015	
3.2 FSI quattro	191	06/05 → 07/10	3.123	B	M	6	24	BPK		82015	
3.7 quattro	206	10/02 → 05/06	3.697	B	A	8	40	BFL		82081	
4.0 TDI quattro	202	05/03 → 07/05	3.936	D	M	8	32	ASE		82046	
4.2 quattro	246	10/02 → 07/10	4.172	B	M	8	40	BFM		82081	

**AUDI**
**A8 II**

4.2 TDI quattro	235	01/05 → 06/05	4.134	D	M	8	32	BMC		82046
	240	07/05 → 07/10	4.134	D	M	8	32	BVN		82046

**A8 III**

2.0 TFSI hybrid	155	02/12 →	1.984		M	4	16	CHJA		84016	<b>NEW</b>
3.0 TDI	150	09/11 →	2.967	D	M	6	24	CLAB		84021	<b>NEW</b>
3.0 TDI quattro	155	08/10 →	2.967	D	M	6	24	CDTB, CTBB		84021	<b>NEW</b>
	184	07/10 →	2.967	D	M	6	24	CDTA, CDTC, CMHA		84021	<b>NEW</b>

**Allroad**

2.5 TDI quattro	120	05/03 → 08/05	2.496	D	M	6	24	BCZ		81705
	132	05/00 → 08/05	2.496	D	M	6	24	AKE, BAU		81705
2.7 quattro	187	09/00 → 08/05	2.671	B	M	6	30	APB, BEL		81842
2.7 T quattro	184	05/00 → 08/05	2.671	B	M	6	30	ARE, BES		81842
4.2 V8 quattro	220	07/02 → 08/05	4.163	B	M	8	40	BAS		82046

**Cabriolet**

1.8	92	01/97 → 08/00	1.781	B	M	4	20	ADR	(-)COP	81526
	92	01/97 → 08/00	1.781	B	M	4	20	ADR	(+)COP	81529
1.9 TDI	66	06/95 → 08/00	1.896	D	M	4	8	1Z, AHU	(-)COP	81522
	66	06/95 → 08/00	1.896	D	M	4	8	1Z, AHU	(+)COP	82080
2.0 16V	103	06/95 → 07/96	1.984	B	M	4	16	ACE	(-)COP	81522
	103	06/95 → 07/96	1.984	B	M	4	16	ACE	(+)COP	82080
2.0 E	85	01/93 → 07/98	1.984	B	M	4	8	ABK	(-)COP	81522
	85	01/93 → 07/98	1.984	B	M	4	8	ABK	(+)COP	82080
2.3 E	98	05/91 → 07/94	2.309	B	M	5	10	NG		81700

**Coupé II**

1.8	82	08/89 → 07/91	1.781	B	M	4	8	DZ	→ 12-1990, → T: F88-M-033.000	81683
	82	08/89 → 07/91	1.781	B	M	4	8	DZ	01-1991 →, T →: F88-M-033-001	81700
2.0	82	03/90 → 07/90	1.984	B	M	4	8	3A	(-)COP	81522
	82	03/90 → 07/90	1.984	B	M	4	8	3A	(+)COP	82080
	83	05/89 → 03/90	1.984	B	M	4	8	3A	(-)COP	81522
	83	05/89 → 03/90	1.984	B	M	4	8	3A	(+)COP	82080
	85	05/89 → 12/96	1.984	B	M	4	8	AAD, ABK	(-)COP	81522
	85	05/89 → 12/96	1.984	B	M	4	8	AAD, ABK	(+)COP	82080
2.0 16 V	101	01/92 → 07/92	1.984	B	M	4	16	6A	(-)COP	81522
	101	01/92 → 07/92	1.984	B	M	4	16	6A	(+)COP	82080
	103	08/92 → 12/96	1.984	B	M	4	16	ACE	(-)COP	81522
	103	08/92 → 12/96	1.984	B	M	4	16	ACE	(+)COP	82080
2.0 20 V	118	08/89 → 07/91	1.994	B	M	5	20	NM	→ T: F88-M-033.000	81683
	118	08/89 → 07/91	1.994	B	M	5	20	NM	T →: F88-M-033.001	81700
2.0 20 V quattro	118	08/89 → 07/91	1.994	B	M	5	20	NM	→ T: F88-M-033.000	81683
	118	08/89 → 07/91	1.994	B	M	5	20	NM	T →: F88-M-033.001	81700
2.2 quattro	100	11/88 → 07/91	2.226	B	M	5	10	KV		81683

**KW**

**cm<sup>3</sup>**

**NO. OF VALVES**

**AUDI**
**Coupé II**

2.3	98	03/90 → 12/96	2.309	B	M	5	10	NG	→ 12-1990, → T: F88-M-033.000	81683
	98	03/90 → 12/96	2.309	B	M	5	10	NG	01-1991 →, T →: F88-M-033-001	81700
	100	10/88 → 07/94	2.309	B	M	5	10	NG	→ 12-1990, → T: F88-M-033.000	81683
	100	10/88 → 07/94	2.309	B	M	5	10	NG	01-1991 →, T →: F88-M-033-001	81700
2.3 20V	123	08/90 → 07/91	2.309	B	M	5	20	7A	→ 12-1990, → T: F88-M-033.000	81683
	123	08/90 → 07/91	2.309	B	M	5	20	7A	01-1991 →, T →: F88-M-033-001	81700
	125	08/89 → 07/91	2.309	B	M	5	20	7A	→ 12-1990, → T: F88-M-033.000	81683
	125	08/89 → 07/91	2.309	B	M	5	20	7A	01-1991 →, T →: F88-M-033-001	81700
2.3 20V quattro	123	05/90 → 12/96	2.309	B	M	5	20	7A	→ 12-1990, → T: F88-M-033.000	81683
	123	05/90 → 12/96	2.309	B	M	5	20	7A	01-1991 →, T →: F88-M-033-001	81700
	125	11/88 → 07/91	2.309	B	M	5	20	7A	→ 12-1990, → T: F88-M-033.000	81683
	125	11/88 → 07/91	2.309	B	M	5	20	7A	01-1991 →, T →: F88-M-033-001	81700
2.3 quattro	98	05/90 → 12/96	2.309	B	M	5	10	NG	→ 12-1990, → T: F88-M-033.000	81683
	98	05/90 → 12/96	2.309	B	M	5	10	NG	01-1991 →, T →: F88-M-033-001	81700
	100	11/88 → 12/92	2.309	B	M	5	10	NG	→ 12-1990, → T: F88-M-033.000	81683
	100	11/88 → 12/92	2.309	B	M	5	10	NG	01-1991 →, T →: F88-M-033-001	81700
S2 quattro	162	09/90 → 09/92	2.226	B	M	5	20	3B	→ T: F88-M-033.000	81700
	169	10/92 → 12/96	2.226	B	M	5	20	ABY		81700
<b>Q3</b>										
1.4 TFSI	110	10/13 →	1.395	B	M	4	16	CHPB, CZDA, CZEA		84062 <b>NEW</b>
2.0 TDI	100	09/11 →	1.968	D	M	4	16	CFFA		84001
	103	09/11 →	1.968	D	M	4	16	CFFB, CLJA		84001
	130	05/13 →	1.968	D	M	4	16	CFGC		84001
2.0 TDI quattro	103	01/12 →	1.968	D	M	4	16	CFFB		84001
	120	06/11 →	1.968	D	M	4	16	CFGD		84001
	130	06/11 →	1.968	D	M	4	16	CFGC, CLLB		84001
2.0 TFSI	132	05/15 →	1.984	B	M	4	16	CULB		84037 <b>NEW</b>

		<b>KW</b>		<b>cm<sup>3</sup></b>				<b>NO. OF VALVES</b>		
--	--	-----------	--	-----------------------	--	--	--	----------------------	--	--

## AUDI

### Q3

2.0 TFSI quattro	125	06/11 →	1.984	B	M	4	16	CCZC		84016	<b>NEW</b>
	132	11/14 →	1.984	B	M	4	16	CULB		84037	<b>NEW</b>
	155	06/11 →	1.984	B	M	4	16	CPSA		84016	<b>NEW</b>
	162	11/14 →	1.984	B	M	4	16			84016	<b>NEW</b>

### Q5

2.0 TDI	100	11/10 →	1.968	D	M	4	16	CJCB, CSUB		84001	
	105	11/10 →	1.968	D	M	4	16	CJCA		84001	
	110	05/13 →	1.968	D	M	4	16	CJCD, CSUA		84001	
2.0 TDI quattro	100	08/09 →	1.968	D	M	4	16	CAGB, CJCB, CSUB	M: 20598	84011	<b>NEW</b>
	100	08/09 →	1.968	D	M	4	16	CAGB, CJCB, CSUB	M: 24941	84001	
	100	08/09 →	1.968	D	M	4	16	CAGB, CJCB, CSUB		84001	
	105	08/09 →	1.968	D	M	4	16	CAGA, CJCA	M: 20597	84011	<b>NEW</b>
	105	08/09 →	1.968	D	M	4	16	CAGA, CJCA	M: 24949	84001	
	105	08/09 →	1.968	D	M	4	16	CAGA, CJCA		84001	
	110	05/13 →	1.968	D	M	4	16	CJCD, CSUA		84001	
	120	11/08 →	1.968	D	M	4	16	CAHB, CGLA, CGLD, CNHC	M: 20864	84011	<b>NEW</b>
	120	11/08 →	1.968	D	M	4	16	CAHB, CGLA, CGLD, CNHC	M: 24943, M: 24406	84001	
	120	11/08 →	1.968	D	M	4	16	CAHB, CGLA, CGLD, CNHC		84001	
	125	11/08 →	1.968	D	M	4	16	CAHA, CGLB, CMGA	M: 20602	84011	<b>NEW</b>
	125	11/08 →	1.968	D	M	4	16	CAHA, CGLB, CMGA	M: 25767, M: 24948	84001	
	125	11/08 →	1.968	D	M	4	16	CAHA, CGLB, CMGA		84001	
130	06/12 →	1.968	D	M	4	16	CGLC, CMGB		84001		
2.0 TFSI hybrid quattro	155	06/11 →	1.984		M	4	16	CHJA		84016	<b>NEW</b>
2.0 TFSI quattro	132	08/09 →	1.984	B	M	4	16	CDNB, CNCB		84016	<b>NEW</b>
	155	11/08 →	1.984	B	M	4	16	CAEB, CDNC, CPMA		84016	<b>NEW</b>
	162	05/13 →	1.984	B	M	4	16	CPMB		84016	<b>NEW</b>
	165	06/12 →	1.984	B	M	4	16	CNCD		84037	<b>NEW</b>
3.0 TDI quattro	155	11/08 →	2.967	D	M	6	24	CCWB		82015	
	176	11/08 →	2.967	D	M	6	24	CCWA, CPNB		82015	
SQ5 TDI quattro	240	04/15 →	2.967	D	M	6	24	CVUB		84021	<b>NEW</b>
<b>Q7 I</b>											
3.0 TDI	150	05/10 → 08/15	2.967	D	M	6	24	CJGC, CJMA		84021	<b>NEW</b>
	155	03/06 → 05/10	2.967	D	M	6	24	BUN, CASB		82015	
	165	06/09 → 05/12	2.967	D	M	6	24	CATA		82015	
	171	03/06 → 05/08	2.967	D	M	6	24	BUG		82015	
	176	11/07 → 08/15	2.967	D	M	6	24	CASA, CCMA, CJGA, CNRB		82015	
	180	05/11 → 08/15	2.967	D	M	6	24	CJGD, CLZB, CRCA		84021	<b>NEW</b>

**KW**

**cm<sup>3</sup>**

**NO. OF VALVES**

**MAGNETI MARELLI**
**AUDI**
**Q7 I**

3.0 TFSI	200	05/10 → 08/15	2.995	B	M	6	24	CJTC, CJWC	82015
	206	05/11 → 08/15	2.995	B	M	6	24	CJWE, CTWB	82015
	245	05/10 → 08/15	2.995	B	M	6	24	CJTb, CJWB, CNAa, CTWA	82015
3.6 FSI	206	08/06 → 05/10	3.597	B	M	6	24	BHK	81866
4.2 TDI	240	03/07 → 06/09	4.134	D	M	8	32	BTR	82046

**Quattro**

2.2 20V Turbo	162	08/89 → 07/91	2.226	B	M	5	20	RR	81683
---------------	-----	---------------	-------	---	---	---	----	----	-------

**TT I, Roadster**

1.8 T	110	09/02 → 06/06	1.781	B	M	4	20	AUM	81703
	120	09/05 → 06/06	1.781	B	M	4	20	BVP	81703
	132	10/99 → 06/06	1.781	B	M	4	20	AJQ, APP, ATC, AUQ	81703
	132	10/98 → 06/06	1.781	B	M	4	20	AJQ, APP, ATC, AUQ, AWP	81703
	140	09/05 → 06/06	1.781	B	M	4	20	BVR	81703
1.8 T quattro	132	10/98 → 06/06	1.781	B	M	4	20	AJQ, ARY, AUQ, AWP	81703
	140	09/05 → 06/06	1.781	B	M	4	20	BVR	81703
	165	10/98 → 06/06	1.781	B	M	4	20	APX, BAM	81703
	176	03/05 → 06/06	1.781	B	M	4	20	BFV	81703
3.2 VR6 quattro	184	07/03 → 06/06	3.189	B	M	6	24	BHE, BPF	81866

**TT II, Roadster**

1.8 TFSI	118	06/08 → 06/14	1.798	B	M	4	16	CDAA	84016	<b>NEW</b>
2.0 TDI quattro	125	06/08 → 06/14	1.968	D	M	4	16	CBBB, CFGB	81816	
	125	06/08 → 06/14	1.968	D	M	4	16	CBBB, CFGB	84011	<b>NEW</b>
2.0 TFSI	147	08/06 → 06/10	1.984	B	M	4	16	BPY, BWA, CCTA	82025	
	155	05/10 → 06/14	1.984	B	M	4	16	CESA	84016	<b>NEW</b>
2.0 TFSI quattro	147	06/08 → 06/10	1.984	B	M	4	16	BWA, CCZA	82025	
	147	06/08 → 06/10	1.984	B	M	4	16	CCZA	82025	
	155	05/10 → 06/14	1.984	B	M	4	16	CESA, CETA	84016	<b>NEW</b>
2.0 TTS quattro	195	05/08 → 06/14	1.984	B	M	4	16	CDLA, CDMA	82025	
	200	05/08 → 06/14	1.984	B	M	4	16	CDLB	82025	
3.2 V6 quattro	184	08/06 → 06/10	3.189	B	M	6	24	BUB	81866	

**TT III, Roadster**

1.8 TFSI	132	08/15 →	1.798	B	M	4	16	CJSA	84037	<b>NEW</b>
2.0 TFSI	169	07/14 →	1.984	B	M	4	16	CHHC	84037	<b>NEW</b>
2.0 TFSI quattro	169	07/14 →	1.984	B	M	4	16	CHHC	84037	<b>NEW</b>
	215	07/15 →	1.984	B	M	4	16	CYFB	84037	<b>NEW</b>
2.0 TTS quattro	210	02/15 →	1.984	B	M	4	16	CJXF	84037	<b>NEW</b>
	228	11/14 →	1.984	B	M	4	16	CJXG	84037	<b>NEW</b>

**KW**

**cm<sup>3</sup>**

**NO. OF VALVES**

## AUSTIN

### Metro

1.0	30	10/80 → 04/90	999	B	M	4	8	99H	BC	81419
	33	10/80 → 04/90	999	B	M	4	8	99H	BC	81419
1.0 Surf HLE	35	10/80 → 04/90	999	B	M	4	8	99HA65P	BC	81419
1.3	51	10/80 → 04/90	1.275	B	M	4	8	12HA83AA	BC	81419
1.3 L,HLE,S	44	10/80 → 04/90	1.275	B	M	4	8	12H	BC	81419
1.3 Surf	44	11/85 → 04/90	1.273	B	M	4	8	12HC21AA	BC	81419
1.3 Turbo	66	10/83 → 04/90	1.275	B	M	4	8	12HA85AA	BC	81419

### Mini

1000 Mayfair	31	08/82 → 06/93	998	B	M	4	8	99H997P, 99HA53P, 99HC20P	BC	81419
1000 Mayfair Sport	30	09/88 → 06/93	999	B	M	4	8	99HD81	BC	81419

## AUTOBIANCHI

### Y10

1.0	33	03/85 → 10/95	999	B	M	4	8	156A2.000		81801
	41	03/85 → 10/95	1.049	B	M	4	8	156A.000		81434
1.0 4WD	37	12/86 → 10/95	999	B	M	4	8	156A3.000		81801
1.0 Cat.	33	10/87 → 10/95	999	B	M	4	8	156A2.246		81801
1.0 Turbo	63	03/85 → 10/95	1.049	B	M	4	8	156A1.000		81434
1.1	42	06/89 → 10/95	1.108	B	M	4	8	156C.000		81801
1.1 4WD	42	06/89 → 10/95	1.108	B	M	4	8	156C.000		81801
1.1 i.e. Cat.	42	09/90 → 10/95	1.108	B	M	4	8	156C.046		81801
1.3 i.e. GT	54	06/89 → 10/95	1.297	B	M	4	8	146A5.046		81434
	57	06/89 → 10/95	1.301	B	M	4	8	156B.000		81434

## BMW

### 1 I (E81, E87), Coupé (E82), Cabrio (E88)

116 d	66	01/11 → 12/11	1.995	D	M	4	16	N47D20A, N47D20C		84000
	66	01/11 → 12/11	1.995	D	M	4	16	N47D20C		84000
	85	12/08 → 09/12	1.995	D	M	4	16	N47D20A		84000
	85	11/08 → 09/12	1.995	D	M	4	16	N47D20A, N47D20C		84000
116 i	85	11/03 → 09/12	1.596	B	M	4	16	N43B16A, N45B16A		82010
	85	03/07 → 09/12	1.596	B	M	4	16	N45B16A		82010
	90	03/07 → 09/12	1.599	B	M	4	16	N43B16A, N45B16A		82010
118 d	90	11/03 → 09/12	1.995	D	M	4	16	M47D20 (204D4), N47D20A, N47D20C		82040
	100	11/03 → 09/12	1.995	D	M	4	16	M47D20 (204D4), N47D20A, N47D20C		84000
	100	09/06 → 09/12	1.995	D	M	4	16	N47D20A, N47D20C		84000
	100	09/09 → 10/13	1.995	D	M	4	16	N47D20C		84000
	105	11/03 → 09/12	1.995	D	M	4	16	M47D20 (204D4), N47D20A, N47D20C		84000
	105	09/06 → 09/12	1.995	D	M	4	16	N47D20A, N47D20C		84000
	105	09/09 → 10/13	1.995	D	M	4	16	N47D20C		84000

**KW**

**cm<sup>3</sup>**

**NO. OF VALVES**

**MAGNETI MARELLI**
**BMW**
**1 I (E81, E87), Coupé (E82), Cabrio (E88)**

118 i	95	07/04 → 09/12	1.995	B	M	4	16	N43B20A, N46B20B		82010
	100	07/04 → 09/12	1.995	B	M	4	16	N43B20A, N46B20B	M: N46NB20B	82010
	100	09/08 → 12/13	1.995	B	M	4	16	N46B20B		82010
	105	03/08 → 12/13	1.995	B	M	4	16	N43B20A		82010
	105	09/06 → 09/12	1.995	B	M	4	16	N43B20A, N46B20B		82010
120 d	120	03/07 → 09/12	1.995	D	M	4	16	M47D20 (204D4), N47D20A, N47D20C		82040
	120	03/08 → 12/13	1.995	D	M	4	16	N47D20A, N47D20C		84000
	130	11/03 → 09/12	1.995	D	M	4	16	M47D20 (204D4), N47D20A, N47D20C		84000
	130	09/06 → 09/12	1.995	D	M	4	16	N47D20A, N47D20C		84000
	145	03/08 → 12/13	1.995	D	M	4	16	N47D20C		84000
120 i	110	11/03 → 09/12	1.995	B	M	4	16	N46B20B, N46B20BD, N46B20C, N46B20CC, N46B20CD		82010
	115	11/03 → 09/12	1.995	B	M	4	16	N46B20A, N46B20B, N46B20BD, N46B20C, N46B20CC, N46B20CD		82010
	115	09/09 → 10/13	1.995	B	M	4	16	N46B20B		82010
	115	09/06 → 09/12	1.995	B	M	4	16	N46B20B, N46B20C		82010
	115	03/08 → 12/13	1.995	B	M	4	16	N46B20B, N46B20C, N46B20E		82010
	125	03/08 → 12/13	1.995	B	M	4	16	N43B20A		82010
	125	02/07 → 09/12	1.995	B	M	4	16	N43B20A, N46B20B, N46B20BD, N46B20C, N46B20CC, N46B20CD		82010
123 d	125	09/06 → 09/12	1.995	B	M	4	16	N43B20A, N46B20B, N46B20C		82010
	150	03/07 → 09/12	1.995	D	M	4	16	N47D20B, N47D20C, N47D20D		84000
	150	03/07 → 09/12	1.995	D	M	4	16	N47D20B, N47D20D		84000

**1 II (F20, F21)**

114 i	75	11/11 →	1.598	B	M	4	16	N13B16A	→ 11-2012	82032
116 i	100	12/10 →	1.598	B	M	4	16	N13B16A	→ 11-2012	82032
118 i	100	03/15 →	1.598	B	M	4	16	N13B16A	→ 11-2012	82032
	125	11/10 →	1.598	B	M	4	16	N13B16A	→ 11-2012	82032
120 i	130	03/15 →	1.598	B	M	4	16	N13B16A	→ 11-2012	82032

**2 Coupé (F22, F87), Cabrio (F23), Active Tourer (F45), Gran Tourer (F46)**

216 i	75	11/15 →	1.499	B	M	3	12	B38A15A		84049	<b>NEW</b>
218 d	100	03/15 →	1.995	D	M	4	16	B47C20A		84051	<b>NEW</b>
218 d xDrive	100	03/15 →	1.995	D	M	4	16	B47C20A		84051	<b>NEW</b>
	100	11/15 →	1.995	D	M	4	16			84051	<b>NEW</b>
	110	11/15 →	1.995	D	M	4	16	B47C20A		84051	<b>NEW</b>

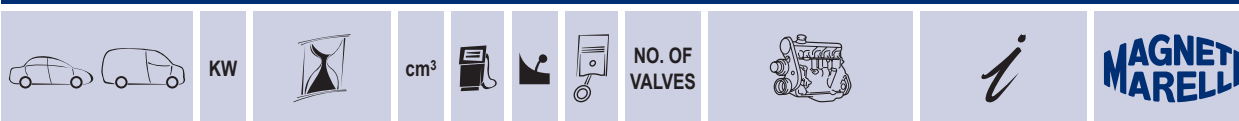

**BMW**
**2 Coupè (F22, F87), Cabrio (F23), Active Tourer (F45), Gran Tourer (F46)**

218 i	100	03/15 →	1.499	B	M	3	12	B38A15A		84049	<b>NEW</b>
	100	09/14 →	1.499	B	M	3	12	B38A15A, B38A15MO		84049	<b>NEW</b>
220 d	140	07/15 →	1.995	D	M	4	16	B47C20A		84051	<b>NEW</b>
220 i	120	11/14 →	1.998	B	M	4	16	B48A20A		84049	<b>NEW</b>
	141	11/14 →	1.998	B	M	4	16	B48A20A		84049	<b>NEW</b>
225 i	170	09/14 →	1.998	B	M	4	16	B48A20B		84049	<b>NEW</b>
225 i xDrive	170	11/14 →	1.998	B	M	4	16	B48A20B		84049	<b>NEW</b>

**3 II (E30), Touring, Cabrio**

316	66	09/82 → 12/90	1.766	B	M	4	8	M10B18 (184VC), M10B18 (184VD)	→ 09-1987	81584
	66	09/82 → 12/90	1.766	B	M	4	8	M10B18 (184VC), M10B18 (184VD)	10-1987 →	81587
316 i	73	09/87 → 06/91	1.596	B	M	4	8	M40B16 (164E1)	→ 09-1988	81584
	73	09/87 → 06/91	1.596	B	M	4	8	M40B16 (164E1)	10-1988 →	81587
	73	09/91 → 06/94	1.596	B	M	4	8	M40B16 (164E1)		81587
	75	07/88 → 06/91	1.596	B	M	4	8	M40B16 (164E1)	→ 09-1988	81584
	75	07/88 → 06/91	1.596	B	M	4	8	M40B16 (164E1)	10-1988 →	81587
	75	09/91 → 06/94	1.596	B	M	4	8	M40B16 (164E1)		81587
318 i	83	09/87 → 06/91	1.796	B	M	4	8	M40B18 (184E1)		81587
	83	04/89 → 06/94	1.796	B	M	4	8	M40B18 (184E1)	M: M40B16	81587
	85	09/87 → 06/91	1.796	B	M	4	8	M40B18 (184E1)		81587
	103	06/88 → 02/92	1.796	B	M	4	8	M40B18C		81587
318 is	100	09/89 → 08/91	1.796	B	M	4	16	M42B18 (184S1)		81590
320 i	95	04/86 → 10/93	1.990	B	M	6	12	M20B20 (206KA)	→ 09-1987	81586
	95	04/86 → 10/93	1.990	B	M	6	12	M20B20 (206KA)	10-1987 →	81616
	110	12/85 → 06/90	1.990	B	M	6	12	M20B20 (206KA)	→ 09-1987	81586
	110	12/85 → 06/90	1.990	B	M	6	12	M20B20 (206KA)	10-1987 →	81616
	95	01/88 → 12/91	1.991	B	M	6	12	M20B20 (206KA)		81616
	95	12/85 → 06/91	1.991	B	M	6	12	M20B20 (206KA), M20B20 (L-Jetronic)	→ 09-1987	81586
	95	12/85 → 06/91	1.991	B	M	6	12	M20B20 (206KA), M20B20 (L-Jetronic)	10-1987 →	81616
320 is	141	05/88 → 12/90	1.990	B	M	4	16	S14B20 (204EA)		81616

**KW**

**cm<sup>3</sup>**

**NO. OF VALVES**

**BMW**
**3 II (E30), Touring, Cabrio**

325 i	125	12/86 → 06/91	2.494	B	M	6	12	M20B25 (256E1), M20B25 (256E2), M20B25 (256EX), M20B25 (256K1)	→ 09-1987	81586
	125	12/86 → 06/91	2.494	B	M	6	12	M20B25 (256E1), M20B25 (256E2), M20B25 (256EX), M20B25 (256K1)	10-1987 →	81616
	125	09/87 → 10/93	2.494	B	M	6	12	M20B25 (256E2), M20B25 (256EX), M20B25 (256K1)		81616
	125	07/87 → 03/93	2.494	B	M	6	12	M20B25 (256K1)		81616
325 i X	125	12/86 → 08/91	2.494	B	M	6	12	M20B25 (256E1), M20B25 (256E2), M20B25 (256EX), M20B25 (256K1)	→ 09-1987	81586
	125	12/86 → 08/91	2.494	B	M	6	12	M20B25 (256E1), M20B25 (256E2), M20B25 (256EX), M20B25 (256K1)	10-1987 →	81616
	125	06/88 → 10/93	2.494	B	M	6	12	M20B25 (256K1)		81616
M3 2.3	143	06/88 → 06/91	2.303	B	M	4	16	S14B23 (234EA)		81586
	143	07/86 → 06/91	2.303	B	M	4	16	S14B23 (234EA), S14B23 (234S1), S14B23 (234S2)		81586
	158	06/89 → 06/91	2.303	B	M	4	16	S14B23 (234EA)		81586

**3 III (E36), Touring, Cabrio, Coupé, Compact**

316 g	75	03/94 → 08/00	1.596	BF	M	4	8	M43B16 (164E2)		81590
316 i	73	09/90 → 09/93	1.596	B	M	4	8	M40B16 (164E1)	M: M40B16	81589
	73	09/90 → 09/93	1.596	B	M	4	8	M40B16 (164E1)	M: M43B16 / C / K	81590
	75	07/93 → 02/98	1.596	B	M	4	8	M43B16 (164E2)		81590
	75	03/94 → 08/00	1.596	B	M	4	8	M43B16 (164E2)	M: M43B16 / C / K	81590
	75	09/90 → 09/93	1.596	B	M	4	8	M43B16, M43B16 (164E2)		81589
	77	12/98 → 08/00	1.895	B	M	4	8	M43B19 (194E1)		81590
318 i	83	12/90 → 10/93	1.796	B	M	4	8	M40B18 (184E1)	M: M40B16	81589
	85	10/93 → 02/98	1.796	B	M	4	8	M43B18 (184E2)	M: M40B16	81590
	85	01/94 → 04/99	1.796	B	M	4	8	M43B18 (184E2)	M: M43B19C	81590
	85	07/95 → 10/99	1.796	B	M	4	8	M43B18 (184E2)	M: M43B18 / C	81590
318 is	103	03/93 → 02/98	1.796	B	M	4	16	M42B18 (184S1)		81590
	103	09/95 → 02/98	1.895	B	M	4	16	M44B19 (194S1)		81590
318 tds	66	01/95 → 02/98	1.665	D	M	4	8	M41D17 (174T1)		81597
318 ti	103	11/94 → 08/95	1.796	B	M	4	16	M42B18 (184S1)		81590
	103	07/95 → 08/00	1.895	B	M	4	16	M44B19 (194S1)	M: M44B19 / C	81590

**KW**

**cm<sup>3</sup>**

**NO. OF VALVES**

**BMW**
**3 III (E36), Touring, Cabrio, Coupé, Compact**

320 i	110	09/90 → 02/98	1.991	B	M	6	24	M50B20, M50B20 (206S1), M50B20 (206S2), M50B20TU, M52B20, M52B20 (206S3)		81588
	110	12/93 → 04/99	1.991	B	M	6	24	M50B20, M50B20 (206S2), M50B20TU, M52B20, M52B20 (206S3)		81588
	110	01/95 → 10/99	1.991	B	M	6	24	M50B20, M50B20TU, M52B20, M52B20 (206S3)		81588
323 i	125	03/95 → 04/99	2.494	B	M	6	24	M52B25 (256S3)	04-1995 →	81588
	125	06/95 → 04/99	2.494	B	M	6	24	M52B25 (256S3)		81588
323 i 2.5	125	03/95 → 02/98	2.494	B	M	6	24	M52B25 (256S3)	04-1995 →	81588
323 ti	125	08/97 → 08/00	2.494	B	M	6	24	M52B25 (256S3)		81588
325 i	141	09/90 → 09/95	2.494	B	M	6	24	M50B25 (256S1), M50B25 (256S2), M50B25TU		81588
	141	03/93 → 03/95	2.494	B	M	6	24	M50B25 (256S2), M50B25TU		81588
325 td	85	09/91 → 02/98	2.497	D	M	6	12	M51D25 (256T1)		81597
325 tds	105	05/93 → 02/98	2.503	D	M	6	12	M51D25 (256T1)		81597
328 i	142	01/95 → 02/98	2.793	B	M	6	24	M52B28 (286S1), M52B28TU		81588

**3 IV (E46), Touring, Cabrio, Coupé, Compact**

316 Ci	77	04/00 → 07/06	1.596	B	M	4	8	M43B16 (164E3)	→ 06-2001	81590
	77	04/00 → 07/06	1.596	B	M	4	8	M43B16 (164E3)	06-2001 →	82010
	85	06/02 → 07/06	1.596	B	M	4	16	N45B16A		82010
316 i	77	04/00 → 02/05	1.596	B	M	4	8	M43B16, M43B16 (164E3)	06-2002 →	82010
	77	04/00 → 02/05	1.596	B	M	4	8	M43B16, M43B16 (164E3)		81590
	85	06/02 → 02/05	1.596	B	M	4	16	N40B16A, N45B16A		82010
	85	06/02 → 02/05	1.596	B	M	4	16	N45B16, N45B16A		82010
	85	02/02 → 02/05	1.796	B	M	4	16	N42B18A, N46B18, N46B18A		82010
	77	09/98 → 02/05	1.895	B	M	4	8	M43B19 (194E1), M43B19TU		81590
316 ti	85	06/02 → 02/05	1.596	B	M	4	16	N40B16A, N45B16A		82010
	85	06/01 → 02/05	1.796	B	M	4	16	N42B18A, N46B18A		82010
318 Ci	87	11/99 → 09/01	1.895	B	M	4	8	M43B19 (194E1)		81590
	105	09/01 → 12/07	1.995	B	M	4	16	N42B20A, N46B20A		82010
	110	03/05 → 07/06	1.995	B	M	4	16	N46B20A		82010
	110	02/05 → 12/07	1.995	B	M	4	16	N46B20A, N46B20B		82010

**KW**

**cm<sup>3</sup>**

**NO. OF VALVES**

**MAGNETI MARELLI**
**BMW**
**3 IV (E46), Touring, Cabrio, Coupé, Compact**

318 d	85	09/01 → 03/03	1.951	D	M	4	16	M47D20, M47D20 (204D1)		81793
	85	03/03 → 02/05	1.995	D	M	4	16	M47D20 (204D4), M47N204D4	→ 03-2004	82040
	85	03/03 → 02/05	1.995	D	M	4	16	M47D20 (204D4), M47N204D4	04-2004 →	82040
318 i	85	10/99 → 09/01	1.895	B	M	4	8	M43B19 (194E1)		81590
	87	02/98 → 09/01	1.895	B	M	4	8	M43B19 (194E1), M43B19TU		81590
	105	09/01 → 02/05	1.995	B	M	4	16	N42B20A, N46B20, N46B20A		82010
318 td	85	03/03 → 02/05	1.995	D	M	4	16	M47D20 (204D4), M47N204D4	→ 03-2004	82040
	85	03/03 → 02/05	1.995	D	M	4	16	M47D20 (204D4), M47N204D4	04-2004 →	82040
318 ti	105	09/01 → 02/05	1.995	B	M	4	16	N42B20A, N46B20A		82010
320 Cd	110	02/05 → 12/07	1.995	D	M	4	16	M47D20 (204D4)	C: A	82034
	110	02/05 → 12/07	1.995	D	M	4	16	M47D20 (204D4)		82040
	110	11/03 → 07/06	1.995	D	M	4	16	M47D20 (204D4), M47N204D4	→ 03-2004	82040
	110	11/03 → 07/06	1.995	D	M	4	16	M47D20 (204D4), M47N204D4	04-2004 →	82040
	110	11/03 → 07/06	1.995	D	M	4	16	M47D20 (204D4), M47N204D4	C: A	82034
320 Ci	110	08/99 → 09/00	1.991	B	M	6	24	M52B20, M52B20 (206S4)	C: M	81588
	120	01/06 → 12/07	2.171	B	M	6	24	M54B22 (226S1)		81588
	125	09/00 → 12/07	2.171	B	AM	6	24	M54226S1, M54B22 (226S1)		81588
	125	09/00 → 07/06	2.171	B	M	6	24	M54B22, M54B22 (226S1)		81588
320 d	95	02/98 → 04/05	1.951	D	M	4	16	M47D20 (204D1)		81793
	100	04/98 → 09/01	1.951	D	M	4	16	M47204D1, M47D20 (204D1)	M: M47204D1	81793
	100	04/98 → 09/01	1.951	D	M	4	16	M47204D1, M47D20 (204D1)	M: M47D20	81794
	100	03/00 → 09/01	1.951	D	M	4	16	M47204D1, M47D20 (204D1)		81793
	100	03/00 → 09/01	1.951	D	M	4	16	M47204D1, M47D20 (204D1)		81794
	110	09/01 → 02/05	1.995	D	M	4	16	M47D20 (204D4)	→ 03-2004	82040
	110	09/01 → 02/05	1.995	D	M	4	16	M47D20 (204D4)	04-2004 →	82040
	110	09/01 → 02/05	1.995	D	M	4	16	M47D20 (204D4)	C: A	82034

**KW**

**cm<sup>3</sup>**

**NO. OF VALVES**

**MAGNETI MARELLI**
**BMW**
**3 IV (E46), Touring, Cabrio, Coupé, Compact**

320 i	110	03/98 → 09/00	1.991	B	M	6	24	M52B20, M52B20 (206S4)		81588
	125	09/00 → 02/05	2.171	B	M	6	24	M54B22, M54B22 (226S1)		81588
320 td	110	09/01 → 02/05	1.995	D	M	4	16	M47D20 (204D4), M47N204D4	→ 03-2004	82040
	110	09/01 → 02/05	1.995	D	M	4	16	M47D20 (204D4), M47N204D4	04-2004 →	82040
323 Ci	125	04/00 → 09/00	2.494	B	M	6	24	M52B25 (256S4)		81588
323 i	125	03/98 → 09/00	2.494	B	M	6	24	M52B25 (256S4), M52B25TU		81588
325 Ci	141	09/00 → 07/06	2.494	B	M	6	24	M54256S5, M54B25 (256S5)		81588
	141	09/00 → 12/07	2.494	B	AM	6	24	M54256S5, M54B25 (256S5)		81588
325 i	141	09/00 → 02/05	2.494	B	M	6	24	M54B25, M54B25 (256S5)		81588
325 ti	141	06/01 → 02/05	2.494	B	M	6	24	M54B25, M54B25 (256S5)		81588
325 xi	141	09/00 → 02/05	2.494	B	M	6	24	M54256S5, M54B25 (256S5)		81588
328 Ci	142	04/99 → 06/00	2.793	B	M	6	24	M52B28 (286S2)		81588
328 i	142	02/98 → 06/00	2.793	B	M	6	24	M52B28 (286S2)		81588
330 Cd	150	08/05 → 12/07	2.993	D	M	6	24	M57D30 (306D2), M57N306D2		82034
330 Ci	170	06/00 → 12/07	2.979	B	AM	6	24	M54306S3, M54B30 (306S3)		81588
	170	06/00 → 07/06	2.979	B	M	6	24	M54B30 (306S3)		81588
330 d	135	10/99 → 02/05	2.926	D	M	6	24	M57D30 (306D1)		81795
	150	03/03 → 02/05	2.993	D	M	6	24	M57D30 (306D2), M57N306D2		82034
330 i	170	06/00 → 02/05	2.979	B	M	6	24	M54B30, M54B30 (306S3)		81588
330 xd	135	06/00 → 02/05	2.926	D	M	6	24	M57D30 (306D1)		81795
	150	03/03 → 02/05	2.993	D	M	6	24	M57D30 (306D2), M57N306D2		82034
330 xi	170	06/00 → 02/05	2.979	B	M	6	24	M54B30 (306S3)		81588
<b>3 V (E90), Touring (E91), Cabrio (E93), Coupé (E92)</b>										
316 d	85	07/09 → 12/11	1.995	D	M	4	16	N47D20C		84000
316 i	85	02/06 → 12/11	1.596	B	M	4	16	N45B16, N45B16A, N45B16TU2		82010

**KW**

**cm<sup>3</sup>**

**NO. OF VALVES**

**BMW**
**3 V (E90), Touring (E91), Cabrio (E93), Coupé (E92)**

318 d	90	09/05 → 12/11	1.995	D	M	4	16	M47D20 (204D4)		82040
	100	07/07 → 12/11	1.995	D	M	4	16	N47D20C		84000
	105	09/05 → 12/11	1.995	D	M	4	16	N47D20A, N47D20C		82040
	105	09/07 → 06/12	1.995	D	M	4	16	N47D20A, N47D20C		84000
318 i	95	09/05 → 03/07	1.995	B	M	4	16	N46B20, N46B20B		82010
	100	06/07 → 12/11	1.995	B	M	4	16	N46B20B, N46B20E		82010
320 d	110	09/05 → 06/12	1.995	D	M	4	16	M47D20 (204D4), M47D20TU		82040
	110	09/05 → 12/11	1.995	D	M	4	16	M47D20 (204D4), M47N204D4		82040
	120	01/05 → 12/11	1.995	D	M	4	16	M47D20 (204D4), N47D20C		82040
	120	01/07 → 12/13	1.995	D	M	4	16	N47D20C	→ 02-2010	84000
	130	03/07 → 12/13	1.995	D	M	4	16	N47D20A	→ 02-2010	84000
	130	09/07 → 12/11	1.995	D	M	4	16	N47D20A, N47D20C		84000
	135	01/10 → 06/12	1.995	D	M	4	16	N47D20C		84000
320 d xDrive	120	07/08 → 12/11	1.995	D	M	4	16	N47D20C		84000
	130	09/08 → 12/11	1.995	D	M	4	16	N47D20C		84000
	130	09/08 → 12/13	1.995	D	M	4	16	N47D20C	→ 02-2010	84000
	135	01/10 → 06/12	1.995	D	M	4	16	N47D20C		84000
320 i	110	03/07 → 08/07	1.995	B	M	4	16	N46B20, N46B20A		82010
	110	01/05 → 03/07	1.995	B	M	4	16	N46B20, N46B20A, N46B20B, N46B20C		82010
	110	09/05 → 06/12	1.995	B	M	4	16	N46B20, N46B20A, N46B20C		82010
	110	11/06 → 06/07	1.995	B	M	4	16	N46B20A		82010
	115	03/07 → 12/13	1.995	B	M	4	16	N46B20B		82010
	115	03/07 → 12/11	1.995	B	M	4	16	N46B20B, N46B20C, N46B20CC, N46B20CD, N46B20E		82010
	125	03/07 → 12/13	1.995	B	M	4	16	N43B20A		82010
320 si	127	05/06 → 12/11	1.997	B	M	4	16	N45B20A		82010
320 xd	130	03/07 → 12/13	1.995	D	M	4	16	N47D20A		84000
	130	09/07 → 12/11	1.995	D	M	4	16	N47D20C		84000

	KW		cm <sup>3</sup>				NO. OF VALVES			
--	----	--	-----------------	--	--	--	---------------	--	--	--

**BMW**
**3 V (E90), Touring (E91), Cabrio (E93), Coupé (E92)**

325 d	145	09/06 → 12/11	2.993	D	M	6	24	M57306D3, M57D30 (306D3)		82040
	145	09/06 → 06/12	2.993	D	M	6	24	M57306D3, M57D30 (306D3), M57D30TU2		82040
	145	03/07 → 12/13	2.993	D	M	6	24	M57D30 (306D3)		82040
	145	03/07 → 12/13	2.993	D	M	6	24	M57D30 (306D3), M57D30TU2		82040
	150	04/10 → 12/13	2.993	D	M	6	24	M57N2306D3, N57D30A		84022 <b>NEW</b>
	150	01/10 → 12/11	2.993	D	M	6	24	N57D30A		84022 <b>NEW</b>
	155	01/07 → 12/09	2.993	D	M	6	24	M57D30 (306D3)		82040
330 d	170	03/07 → 12/13	2.993	D	M	6	24	M57D30 (306D3)		82040
	170	09/05 → 12/11	2.993	D	M	6	24	M57D30 (306D3), M57D30TU2		82040
	180	01/09 → 12/11	2.993	D	M	6	24	M57N2306D3, N57D30A		84022 <b>NEW</b>
330 d xDrive	180	01/09 → 12/11	2.993	D	M	6	24	N57D30A		84022 <b>NEW</b>
330 xd	170	09/05 → 12/11	2.993	D	M	6	24	M57D30 (306D3), M57D30TU2		82040
	180	01/09 → 12/13	2.993	D	M	6	24	M57N2306D3, N57D30A		84022 <b>NEW</b>
335 d	210	09/06 → 12/11	2.993	D	M	6	24	M57D30 (306D5), M57N306D5	→ 03-2010	82040
	210	09/06 → 12/13	2.993	D	M	6	24	M57D30 (306D5), M57N306D5		82040

**3 VI (F30, F35, F80), Touring (F31), GT (F34)**

316 i	100	10/12 →	1.598	B	M	4	16	N13B16A	→ 11-2012	82032
320 i	125	02/12 →	1.598	B	M	4	16	N13B16A	→ 11-2012	82032

**5 III (E34), Touring**

518 g	85	11/95 → 06/96	1.796	BF	M	4	8	M43B18 (184E2)		81589
518 i	83	08/89 → 09/95	1.796	B	M	4	8	M40B18 (184E1)	04-1989 →, → 08-1991	81587
	83	03/93 → 09/94	1.796	B	M	4	8	M43B18 (184E2)		81589
	85	08/89 → 09/95	1.796	B	M	4	8	M43B18 (184E2)	→ 09-1991, DST:CND	81587
	85	08/89 → 09/95	1.796	B	M	4	8	M43B18 (184E2)	01-1993 →, DST:CTN	81590
	85	08/89 → 09/95	1.796	B	M	4	8	M43B18 (184E2)	10-1991 →, DST:CND	81589
	85	09/94 → 01/97	1.796	B	M	4	8	M43B18 (184E2)	→ 12-1995	81589
520 i	95	01/88 → 08/91	1.990	B	M	6	12	M20B20 (206KA)		81616
	110	11/91 → 01/97	1.991	B	M	6	24	M50B20, M50B20 (206S1), M50B20 (206S2), M50B20TU		81588

**KW**

**cm<sup>3</sup>**

**NO. OF VALVES**

**BMW**
**5 III (E34), Touring**

520 i 24V	110	09/89 → 09/95	1.991	B	M	6	24	M50B20, M50B20 (206S1), M50B20 (206S2), M50B20TU		81588
524 td	85	03/88 → 09/95	2.443	D	M	6	12	M21D24, M21D24 (246TB)	03-1988 →, → 09-1991	81617
525 i	125	01/88 → 08/91	2.494	B	M	6	12	M20B25 (256K1)		81616
	141	11/91 → 01/97	2.494	B	M	6	24	M50B25 (256S1), M50B25 (256S2)		81588
525 i 24V	141	09/89 → 09/95	2.494	B	M	6	24	M50B25 (256S2), M50B25TU, M52B25 (Vanos)		81588
525 ix	141	02/92 → 01/97	2.494	B	M	6	24	M50B25 (256S1), M50B25 (256S2)		81588
525 iX 24V	141	10/91 → 09/95	2.494	B	M	6	24	M50B25 (256S1), M50B25 (256S2)		81588
525 td	85	04/93 → 09/95	2.497	D	M	6	12	M51D25 (256T1)		81597
525 tds	105	09/91 → 09/95	2.503	D	M	6	12	M51D25 (256T1)		81597
530 i	138	01/88 → 08/91	2.986	B	M	6	12	M30B30 (306KA)	03-1988 →, → 08-1990	81618
535 i	155	01/88 → 09/95	3.430	B	M	6	12	M30B34 (346KB)		81618
M5	232	10/88 → 05/92	3.535	B	M	6	24	S38B36 (366S1)		81618
M5 Cat.	232	10/88 → 05/92	3.535	B	M	6	24	S38B36 (366S1)	03-1988 →, → 06-1994	81618

**5 IV (E39), Touring**

520 d	100	02/00 → 06/03	1.951	D	M	4	16	M47204D1, M47D20 (204D1)		81794
520 i	100	04/99 → 06/03	1.991	B	M	6	24	M52B20 (206S3)		81588
	110	01/96 → 09/00	1.991	B	M	6	24	M52B (206S4), M52B20, M52B20 (206S3)		81588
	125	09/00 → 06/03	2.171	B	M	6	24	M54B22 (226S1)		81588
	125	09/00 → 05/04	2.171	B	M	6	24	M54B22, M54B22 (226S1)		81588
523 i	125	11/95 → 09/00	2.494	B	M	6	24	M52B25 (256S3), M52B25TU		81588
525 d	120	02/00 → 06/03	2.497	D	M	6	24	M57D25 (256D1)		81795
525 i	141	09/00 → 05/04	2.494	B	M	6	24	M54256S5, M54B25, M54B25 (256S5)		81588
	141	09/00 → 06/03	2.494	B	M	6	24	M54B25, M54B25 (256S5)		81588
525 td	85	01/97 → 06/03	2.497	D	M	6	12	M51D25 (256T1)		81597
525 tds	105	01/96 → 06/03	2.503	D	M	6	12	M51D25 (256T1)		81597
528 i	142	11/95 → 09/00	2.793	B	M	6	24	M52B28 (286S1), M52B28 (286S2)		81588



**KW**

**cm<sup>3</sup>**

**NO. OF VALVES**

**BMW**
**5 IV (E39), Touring**

530 d	135	08/98 → 09/00	2.926	D	M	6	24	M57D30 (306D1)	08-1998 →, → 08-1999	81796
	135	08/98 → 09/00	2.926	D	M	6	24	M57D30 (306D1)	09-1999 →, → 09-2000	81795
	142	09/00 → 06/03	2.926	D	M	6	24	M57D30 (306D1)		81795
	142	09/00 → 05/04	2.926	D	M	6	24	M57D30, M57D30 (306D1)		81795
530 i	170	09/00 → 05/04	2.979	B	M	6	24	M54B30 (306S3)		81588
	170	09/00 → 06/03	2.979	B	M	6	24	M54B30, M54B30 (306S3)		81588
540 i	210	01/97 → 05/04	4.398	B	M	8	32	M62448S2, M62B44 (448S1), M62B44 (448S2), M62B44TU	09-1998 →, → 05-2004	81796

**5 V (E60), Touring (E61)**

520 d	110	09/05 → 03/10	1.995	D	M	4	16	M47D20 (204D4)		82040
	110	09/05 → 12/10	1.995	D	M	4	16	M47D20 (204D4), N47D20A, N47D20C		82040
	120	07/05 → 03/10	1.995	D	M	4	16	M47D20 (204D4), N47D20A, N47D20C		82040
	130	09/07 → 03/10	1.995	D	M	4	16	N47D20A, N47D20C		84000
520 i	115	04/06 → 12/09	1.995	B	M	4	16	N46B20B		82010
	125	09/07 → 03/10	1.995	B	M	4	16	N43B20A		82010
	125	07/03 → 03/10	2.171	B	M	6	24	M54B22, M54B22 (226S1)		81588
525 d	120	12/04 → 03/10	2.497	D	M	6	24	M57D25 (256D1)		82040
	120	12/04 → 12/10	2.497	D	M	6	24	M57N256D4		82040
	130	06/04 → 03/10	2.497	D	M	6	24	M57D25 (256D2), M57D25TU		82040
	145	01/07 → 03/10	2.993	D	M	6	24	M57D30 (306D3)		82040
525 d xDrive	145	09/08 → 03/10	2.993	D	M	6	24	M57D30 (306D3)		82040
525 i	141	09/03 → 03/10	2.494	B	M	6	24	M54256S5, M54B25, M54B25 (256S5)		81588
	141	06/04 → 12/10	2.494	B	M	6	24	M54B25, M54B25 (256S5)		81588
525 xd	145	01/07 → 03/10	2.993	D	M	6	24	M57D30 (306D3)		82040

**KW**

**cm<sup>3</sup>**

**NO. OF VALVES**

**MAGNETI MARELLI**
**BMW**
**5 V (E60), Touring (E61)**

530 d	155	07/03 → 03/10	2.993	D	M	6	24	M57D30 (306D2), M57D30 (306D3)		82040
	155	11/05 → 12/10	2.993	D	M	6	24	M57D30 (306D3)		82040
	160	07/03 → 03/10	2.993	D	M	6	24	M57D30 (306D2)	→ 03-2004	82040
	160	07/03 → 03/10	2.993	D	M	6	24	M57D30 (306D2)	04-2004 →	82040
	160	06/04 → 12/10	2.993	D	M	6	24	M57D30 (306D2), N57306D2		82040
	170	07/03 → 03/10	2.993	D	M	6	24	M57D30 (306D3)	→ 03-2004	82040
	170	07/03 → 03/10	2.993	D	M	6	24	M57D30 (306D3)	04-2004 →	82040
	170	07/05 → 12/10	2.993	D	M	6	24	M57D30 (306D3)		82040
530 d xDrive	173	01/07 → 03/10	2.993	D	M	6	24	M57306D3, M57D30 (306D3)		82040
530 i	170	07/03 → 03/10	2.979	B	M	6	24	M54306S3, M54B30, M54B30 (306S3)		81588
530 xd	170	07/05 → 03/10	2.993	D	M	6	24	M57D30 (306D3)		82040
	173	01/07 → 03/10	2.993	D	M	6	24	M57306D3, M57D30 (306D3)		82040
	173	01/07 → 12/10	2.993	D	M	6	24	M57D30 (306D3)		82040
535 d	200	09/04 → 03/10	2.993	D	M	6	24	M57D30 (306D4)		82040
	210	01/07 → 03/10	2.993	D	M	6	24	M57D30 (306D5), M57N306D5		82040

**5 VI (F10), Touring (F11), GT (F07)**

525 d	150	02/10 →	2.993	D	M	6	24	N57D30A		84023	<b>NEW</b>
530 d	155	07/10 →	2.993	D	M	6	24	N57D30A		84023	<b>NEW</b>
	180	12/09 →	2.993	D	M	6	24	N57D30A		84023	<b>NEW</b>
	190	10/09 →	2.993	D	M	6	24	N57D30A		84023	<b>NEW</b>
530 d xDrive	180	09/10 →	2.993	D	M	6	24	N57D30A		84023	<b>NEW</b>
	190	10/09 →	2.993	D	M	6	24	N57D30A		84023	<b>NEW</b>
535 d	220	08/10 →	2.993	D	M	6	24	N57D30B		84023	<b>NEW</b>
535 d xDrive	220	09/10 →	2.993	D	M	6	24	N57D30B		84023	<b>NEW</b>

**6 I (E24)**

635 CSi	141	04/85 → 09/90	3.430	B	M	6	12	M30B35	09-1979 →, → 12-1988	81618
---------	-----	---------------	-------	---	---	---	----	--------	-------------------------	-------

**6 II (E63), Cabrio (E64)**

635 d	210	07/07 → 07/10	2.993	D	M	6	24	M57D30 (306D5), M57N306D5		82040
	210	07/07 → 07/10	2.993	D	M	6	24	M57D30 (306D5), N57N306D5		82040

**7 II (E32)**

730 i,iL	138	12/86 → 09/94	2.986	B	M	6	12	M30B30 (306KA)		81618
	145	12/86 → 09/94	2.986	B	M	6	12	M30B30 (306EA)		81618
735 i,iL	155	09/86 → 09/92	3.430	B	M	6	12	M30B34 (346KB)		81618

--	--	--	--	--	--	--	--	--	--	--

## BMW

### 7 III (E38)

725 tds	105	04/96 → 11/01	2.503	D	M	6	12	M51D25 (256T1)		81597
728 i,iL	142	08/95 → 11/01	2.793	B	M	6	24	M52B28 (286S1), M52B28 (286S2)		81588
728i X	142	11/95 → 09/01	2.793	B	M	6	24	M52B28 (286S1), M52B28TU		81588
730 d	135	08/98 → 04/00	2.926	D	A	6	24	M57D30 (306D1)	→ 09-1999	81796
	135	08/98 → 04/00	2.926	D	A	6	24	M57D30 (306D1)	10-1999 →	81795
	142	04/00 → 11/01	2.926	D	A	6	24	M57D30 (306D1)		81795

### 7 IV (E65, E66)

730 d	155	10/02 → 07/08	2.993	D	M	6	24	M57D30 (306D3), M57N306D2		82034
	160	10/02 → 07/08	2.993	D	M	6	24	M57D30 (306D2)		82034
730 i,Li	170	03/03 → 07/08	2.979	B	M	6	24	M54B30, M54B30 (306S3)		81588
730 Ld	170	07/05 → 12/09	2.993	D	M	6	24	M57306D3, M57D30 (306D3)		82034

### 7 V (F01, F02, F03, F04)

730 d	180	10/08 → 12/15	2.993	D	M	6	24	N57D30A		84023	
740 d	225	09/09 → 12/15	2.993	D	M	6	24	N57D30B		84023	
740 d xDrive	225	09/09 → 12/15	2.993	D	M	6	24	N57D30B		84023	

### X1 I (E84)

sDrive 18 d	100	03/09 → 06/15	1.995	D	M	4	16	N47D20C		84000
	105	10/09 → 06/15	1.995	D	M	4	16	N47D20C		84000
sDrive 18 i	100	03/09 → 06/15	1.995	B	M	4	16	N46B20B		82010
	110	01/10 → 06/15	1.995	B	M	4	16	N46B20B		82010
sDrive 20 d	120	03/10 → 06/15	1.995	D	M	4	16	N47D20C		84000
	130	10/09 → 06/15	1.995	D	M	4	16	N47D20C		84000
xDrive 18 d	100	03/09 → 06/15	1.995	D	M	4	16	N47D20C		84000
	105	10/09 → 06/15	1.995	D	M	4	16	N47D20C		84000
xDrive 20 d	120	03/10 → 06/15	1.995	D	M	4	16	N47D20C		84000
	130	10/09 → 06/15	1.995	D	M	4	16	N47D20C		84000
xDrive 23 d	150	10/09 → 06/15	1.995	D	M	4	16	N47D20C, N47SD20D		84000

### X1 II (F48)

sDrive 18 i	100	11/15 →	1.499	B	M	3	12	B38A15A		84049	
sDrive 20 i	141	09/15 →	1.998	B	M	4	16	B48A20A		84049	
	141	09/15 →	1.998	B	M	4	16	B48A20A		84049	
xDrive 25 i	170	09/15 →	1.998	B	M	4	16	B48A20B		84049	

### X3 I (E83)

2.0 d	110	10/04 → 12/10	1.995	D	M	4	16	M47D20 (204D4)		82040
	130	09/07 → 03/09	1.995	D	M	4	16	N47D20A, N47D20C		84000
2.0 i	110	07/05 → 08/08	1.995	B	M	4	16	N46B20, N46B20B		82010
2.5 i	141	01/04 → 08/06	2.494	B	M	6	24	M54256S5, M54B25, M54B25 (256S5)		81588

**KW**

**cm<sup>3</sup>**

**NO. OF VALVES**

**BMW**
**X3 I (E83)**

3.0 d	150	01/04 → 08/05	2.993	D	M	6	24	M57D30 (306D2), M57N2306D2		82040
	160	01/04 → 08/08	2.993	D	M	6	24	M57D30 (306D3)	→ 03-2010	82040
3.0 i xDrive	170	01/04 → 08/06	2.979	B	M	6	24	M54306S3, M54B30, M54B30 (306S3)		81588
3.0 sd	210	09/06 → 08/08	2.993	D	M	6	24	M57D30 (306D5)		82040
xDrive 18 d	105	09/08 → 12/11	1.995	D	M	4	16	N47D20C		84000
xDrive 20 d	120	09/08 → 08/10	1.995	D	M	4	16	N47D20C		84000
	130	09/08 → 08/10	1.995	D	M	4	16	N47D20C		84000
xDrive 20 i	110	09/08 → 08/11	1.995	B	M	4	16	N46B20B		82010
xDrive 30 d	160	09/08 → 04/11	2.993	D	M	6	24	M57D30 (306D3), M57N2306D3	→ 03-2010	82040
xDrive 35 d	210	09/08 → 08/11	2.993	D	M	6	24	M57D30 (306D5)		82040

**X5 I (E53)**

3.0 d	135	05/01 → 12/03	2.925	D	A	6	24	M57D30 (306D1)		81795
	155	09/03 → 12/06	2.993	D	M	6	24	M57D30 (306D2), M57N306D2		82034
	160	12/03 → 12/06	2.993	D	M	6	24	M57D30 (306D2)		82034
3.0 i	163	05/00 → 12/06	2.979	B	M	6	24	M54B30 (306S3)		81588
	170	05/00 → 12/06	2.979	B	M	6	24	M54306S3, M54B30, M54B30 (306S3)		81588

**X5 II (E70)**

3.0 d	155	02/07 → 09/08	2.993	D	M	6	24	M57D30 (306D3)		82040
	173	02/07 → 09/08	2.993	D	M	6	24	M57306D3, M57D30 (306D3)		82040
3.0 sd	210	09/07 → 02/09	2.993	D	M	6	24	M57D30 (306D5), M57N306D5		82040
xDrive 30 d	155	09/08 → 06/13	2.993	D	M	6	24	N57D30A		84023 <b>NEW</b>
	173	09/08 → 06/13	2.993	D	M	6	24	N57D30A		82040
	180	09/10 → 06/13	2.993	D	M	6	24	N57D30A		84023 <b>NEW</b>
xDrive 35 d	210	09/08 → 06/13	2.993	D	M	6	24	M57D30 (306D5)		82040
xDrive 40 d	225	09/10 → 06/13	2.993	D	M	6	24	N57D30B		84023 <b>NEW</b>

**X6 I (E71, E72)**

30 d	173	05/08 → 08/08	2.993	D	M	6	24	M57D30 (306D3)		82040
35 d	210	05/08 → 08/08	2.993	D	M	6	24	M57D30 (306D5)		82040
xDrive 30 d	155	09/10 → 06/14	2.993	D	M	6	24	N57D30A		84023 <b>NEW</b>
xDrive 30 d	173	09/08 → 06/14	2.993	D	M	6	24	N57D30A		82040
	180	09/10 → 06/14	2.993	D	M	6	24	M57D30 (306D3), M57N2306D3, N57D30A		84023 <b>NEW</b>
xDrive 35 d	210	09/08 → 06/14	2.993	D	M	6	24	M57D30 (306D5), M57N306D5		82040
xDrive 40 d	225	10/10 → 06/14	2.993	D	M	6	24	N57D30B		84023 <b>NEW</b>

--	--	--	--	--	--	--	--	--	--

## BMW

### Z1

2.5	125	06/88 → 06/91	2.494	B	M	6	12	M20B25 (256K1)	11-1988 →, → 10-1991	81616
-----	-----	---------------	-------	---	---	---	----	----------------	-------------------------	-------

### Z3 (E36), Coupé

1.8	85	10/95 → 10/98	1.796	B	M	4	8	M43B18 (184E2)	M: M42B18	81590
-----	----	---------------	-------	---	---	---	---	----------------	-----------	-------

1.9	85	01/99 → 01/03	1.895	B	M	4	8	M43194E1, M43B19 (194E1)	M: M44B19 C	81590
-----	----	---------------	-------	---	---	---	---	-----------------------------	-------------	-------

1.9	87	07/98 → 01/03	1.895	B	M	4	8	M43194E1, M43B19 (194E1), M43B19TU		81590
-----	----	---------------	-------	---	---	---	---	--	--	-------

1.9	103	10/95 → 03/99	1.895	B	M	4	16	M44B19 (194S1)	M: M44B19 C	81590
-----	-----	---------------	-------	---	---	---	----	----------------	-------------	-------

2.0	110	04/99 → 01/03	1.991	B	M	6	24	M52B20, M52B20 (206S4)	04-1999 →	81588
-----	-----	---------------	-------	---	---	---	----	---------------------------	-----------	-------

2.2	125	08/00 → 01/03	2.171	B	M	6	24	M54226S1, M54B22, M54B22 (226S1)		81588
-----	-----	---------------	-------	---	---	---	----	-------------------------------------	--	-------

2.8	141	07/97 → 06/00	2.793	B	M	6	24	M52B28 (286S1)		81588
-----	-----	---------------	-------	---	---	---	----	----------------	--	-------

2.8	141	04/97 → 06/00	2.793	B	M	6	24	M52B28 (286S1), M52B28TU		81588
-----	-----	---------------	-------	---	---	---	----	-----------------------------	--	-------

3.0	170	06/00 → 06/03	2.979	B	M	6	24	M54306S3, M54B30 (306S3)		81588
-----	-----	---------------	-------	---	---	---	----	-----------------------------	--	-------

3.0	170	06/00 → 01/03	2.979	B	M	6	24	M54B30, M54B30 (306S3)		81588
-----	-----	---------------	-------	---	---	---	----	---------------------------	--	-------

### Z4 I (E85), Coupé (E86)

2.0 i	110	03/05 → 02/09	1.995	B	M	4	16	N46B20, N46B20A, N46B20B		82010
-------	-----	---------------	-------	---	---	---	----	-----------------------------	--	-------

2.2 i	125	10/03 → 10/05	2.171	B	M	6	24	M54B22, M54B22 (226S1)		81588
-------	-----	---------------	-------	---	---	---	----	---------------------------	--	-------

2.5 i	141	02/03 → 12/05	2.494	B	M	6	24	M54B25, M54B25 (256S5)		81588
-------	-----	---------------	-------	---	---	---	----	---------------------------	--	-------

3.0 i	170	02/03 → 10/05	2.979	B	M	6	24	M54B30, M54B30 (306S3)		81588
-------	-----	---------------	-------	---	---	---	----	---------------------------	--	-------

## CADILLAC

### BLS, Station Wagon

1.9 D	110	04/06 →	1.910	D	M	4	16	Z19DTH		81872
-------	-----	---------	-------	---	---	---	----	--------	--	-------

1.9 D	132	12/07 →	1.910	D	M	4	16	Z19DTR		81872
-------	-----	---------	-------	---	---	---	----	--------	--	-------

### CTS I

2.8	158	03/05 → 09/07	2.792	B	M	6	24	LP1		84057
-----	-----	---------------	-------	---	---	---	----	-----	--	-------

3.6	189	03/05 → 09/07	3.564	B	M	6	24	LY7		84057
-----	-----	---------------	-------	---	---	---	----	-----	--	-------

### CTS II, Station Wagon, Coupé

2.8	155	01/08 →	2.792	B	M	6	24	LP1		84057
-----	-----	---------	-------	---	---	---	----	-----	--	-------

3.6	229	01/08 →	3.564	B	M	6	24	LLT		84057
-----	-----	---------	-------	---	---	---	----	-----	--	-------

3.6 AWD	229	01/08 →	3.564	B	M	6	24	LLT		84057
---------	-----	---------	-------	---	---	---	----	-----	--	-------

### SRX I

3.6 AWD	190	07/04 → 12/08	3.564	B	M	6	24	LY7		84057
---------	-----	---------------	-------	---	---	---	----	-----	--	-------

**KW**

**cm<sup>3</sup>**

**NO. OF VALVES**

## CADILLAC

### STS

3.6	189	05/05 → 12/07	3.564	B	M	6	24	LY7		84057	<b>NEW</b>
-----	-----	---------------	-------	---	---	---	----	-----	--	-------	------------

## CHEVROLET

### Aveo I

1.2	53	03/06 → 12/07	1.150	B	M	4	8	B12S1, F12S3, LY4		81783	
1.5	62	01/05 → 05/08	1.498	B	M	4	8	F15S3		81781	
	62	05/05 →	1.498	B	M	4	8	F15S3, LX6		81781	
1.6	77	09/03 →	1.598	B	M	4	16	A16DMS, LXT, LXV		81782	

### Aveo II

1.2	51	03/11 →	1.229	B	M	4	16	A12XEL		84027	<b>NEW</b>
	63	03/11 →	1.229	B	M	4	16	A12XER		84027	<b>NEW</b>
1.2 LPG	63	11/12 →	1.229		M	4	16	A12XER		84027	<b>NEW</b>
1.4	74	03/11 →	1.398	B	M	4	16	A14XER		84027	<b>NEW</b>
1.4 Turbo	103	08/13 →	1.364	B	M	4	16	LUJ, LUV		84027	<b>NEW</b>
1.6	85	03/11 →	1.598	B	M	4	16	F16D4		82083	

### Captiva

2.0 D	93	10/06 →	1.991	D	M	4	16	Z20S		84014	<b>NEW</b>
	110	09/07 →	1.991	D	M	4	16	Z20DMH, Z20S		84014	<b>NEW</b>
2.0 D 4WD	93	10/06 →	1.991	D	M	4	16	Z20S		84014	<b>NEW</b>
	110	10/06 →	1.991	D	M	4	16	Z20DMH, Z20S		84014	<b>NEW</b>
2.4	123	03/11 →	2.384	B	M	4	16	A24XE, LE5		81812	
	100	06/06 →	2.405	B	M	4	16	Z24SED		81550	
2.4 4WD	123	03/11 →	2.384	B	M	4	16	A24XE, LE5		81812	
	100	06/06 →	2.405	B	M	4	16	Z24SED		81550	
2.4 LPG	100	01/07 →	2.405		M	4	16	Z24SED		81550	
2.4 LPG 4WD	100	01/07 →	2.405		M	4	16	Z24SED		81550	
3.2 4WD	169	06/06 →	3.195	B	M	6	24	10HM		84057	<b>NEW</b>

### Cruze II, Hatchback, Station Wagon

1.4	103	06/12 →	1.362	B	M	4	16	LUJ		84027	<b>NEW</b>
	103	09/10 →	1.364	B	M	4	16	A14NET, LUJ, LUV		84027	<b>NEW</b>
	74	07/13 →	1.398	B	M	4	16	A14XER, LDD		84027	<b>NEW</b>
	103	10/13 →	1.398	B	M	4	16	A14NET		84027	<b>NEW</b>
1.6	80	05/09 →	1.598	B	M	4	16	F16D3, LXT, LXV		82083	
	80	01/12 →	1.598	B	M	4	16	LXT		82083	
	83	05/09 →	1.598	B	M	4	16	F16D4		82083	
	86	12/12 →	1.598	B	M	4	16	F16D4		82083	
	86	12/12 →	1.598	B	M	4	16	LDE		81782	
	86	12/12 →	1.598	B	M	4	16	LDE		82083	
	91	06/11 →	1.598	B	M	4	16	F16D4		82083	
	91	05/09 →	1.598	B	M	4	16	F16D4, LDE		82083	
	91	08/12 →	1.598	B	M	4	16	LDE		82083	
1.7 D	96	01/12 →	1.686	D	M	4	16	LUD		84005	
1.7 TD	96	08/12 →	1.686	D	M	4	16	LUD		84005	

**KW**

**cm<sup>3</sup>**

**NO. OF VALVES**

**MAGNETI MARELLI**
**CHEVROLET**
**Cruze II, Hatchback, Station Wagon**

1.8	104	08/12 →	1.796	B	M	4	16	2H0		82083
	104	05/09 →	1.796	B	M	4	16	2H0, F18D4		82083
	104	06/11 →	1.796	B	M	4	16	F18D4		82083
1.8 LPG	104	06/11 →	1.796		M	4	16	2H0, F18D4		82083
	104	06/11 →	1.796		M	4	16	F18D4		82083
2.0 CDI	90	05/09 →	1.991	D	M	4	16	Z20S1		84014 <b>NEW</b>
	92	05/09 →	1.991	D	M	4	16	Z20S1		84014 <b>NEW</b>
	110	05/09 →	1.991	D	M	4	16	Z20DMH, Z20S1		84014 <b>NEW</b>

**Epica**

2.0	94	01/05 → 12/06	1.998	B	M	4	16	C20SED		81550
	98	01/05 → 12/06	1.998	B	M	4	16	T20SED		81550
2.0 D	110	01/07 →	1.991	D	M	4	16	Z20S		84014 <b>NEW</b>

**Evanda**

2.0	96	03/05 →	1.998	B	M	4	16	X20SED		81550
-----	----	---------	-------	---	---	---	----	--------	--	-------

**HHR**

2.4	125	10/07 → 12/11	2.384	B	M	4	16	LE5		81812
-----	-----	---------------	-------	---	---	---	----	-----	--	-------

**Kalos**

1.2	53	03/05 →	1.150	B	M	4	8	B12S1		81781
	53	03/05 →	1.150	B	M	4	8	F12S3		81783
1.4	61	03/05 →	1.399	B	M	4	8	F14S3		81782
1.4 16V	69	03/05 →	1.399	B	M	4	16	F14D3		81782

**Lacetti**

1.4 16V	70	03/05 →	1.399	B	M	4	16	F14D3		81782
1.6	80	03/05 →	1.598	B	M	4	16	F16D3		81782
1.8	67	03/05 → 12/09	1.796	B	M	4	8	F18D2		81550
	89	08/05 →	1.796	B	M	4	16	F18D3		81782
	89	08/05 →	1.799	B	M	4	16	T18SED		81550
	90	03/05 →	1.799	B	M	4	16	T18SED		81782
2.0 D	89	01/07 →	1.991	D	M	4	16	Z20DM		84014 <b>NEW</b>

**Malibu**

2.0 D	118	04/12 →	1.956	D	M	4	16	LBS		81872
2.4	123	01/12 →	2.384	B	M	4	16	LE9		81812
	125	01/12 →	2.384	B	M	4	16	LE9		81812

**Matiz**

0.8	38	03/05 →	796	B	M	3	6	F8CV		81783
0.8 LPG	38	03/05 →	796		M	3	6	F8CV		81783
1.0	47	03/05 →	995	B	M	4	8	B10S		81783
	49	03/05 →	995	B	M	4	8	B10S1		81783
1.0 LPG	49	03/05 →	995		M	4	8	B10S1		81783

**Nubira, Station Wagon**

1.4	69	01/05 →	1.399	B	M	4	16	F14D3		81782
	70	01/06 →	1.399	B	M	4	16	F14D3		81782
1.6	80	03/05 →	1.598	B	M	4	16	F16D3		81782

**KW**

**cm<sup>3</sup>**

**NO. OF VALVES**

**MAGNETI MARELLI**

## CHEVROLET

### Nubira, Station Wagon

1.8	89	08/05 →	1.796	B	M	4	16	F18D3		81782
	90	03/05 →	1.799	B	M	4	16	T18SED		81782
2.0 D	89	01/07 →	1.991	D	M	4	16	Z20DM, Z20S		84014 <b>NEW</b>
	89	01/05 →	1.991	D	M	4	16	Z20S		84014 <b>NEW</b>

### Orlando

1.4	103	06/12 →	1.362	B	M	4	16	LUJ		84027 <b>NEW</b>
-----	-----	---------	-------	---	---	---	----	-----	--	------------------

### Rezzo

1.6	77	03/05 →	1.598	B	M	4	16	A16DMS		81782
	79	08/05 →	1.598	B	M	4	16	A16DMS		81782
2.0	89	03/05 →	1.998	B	M	4	16	T20SED		81550
	90	08/05 →	1.998	B	M	4	16	T20SED		81550

### Spark I

0.8	38	09/00 → 12/04	796	B	M	3	6	F8CV		81783
1.0	47	11/02 → 12/04	993	B	M	4	8	G10CV		81783

### Spark II

0.8	37	05/05 →	796	B	M	3	6	F8CV		81783
1.0 SX	46	05/05 →	995	B	M	4	8	B10S, LA2		81783
	49	05/05 →	995	B	M	4	8	B10S1		81783

### Trax

1.4	103	12/12 →	1.364	B	M	4	16	LUJ, LUV		84027 <b>NEW</b>
1.4 AWD	103	12/12 →	1.364	B	M	4	16	LUJ		84027 <b>NEW</b>
1.4 LPG	103	04/13 →	1.364		M	4	16	A14NET, B14NET		84027 <b>NEW</b>
1.6	85	12/12 →	1.598	B	M	4	16	F16D4, LDE		82083
1.7 TD	96	12/12 →	1.686	D	M	4	16	LUD		84005
1.7 TD AWD	96	12/12 →	1.686	D	M	4	16	LUD		84005

## CHRYSLER

### 300 C, Touring

3.0 CRD	160	09/05 → 11/12	2.987	D	M	6	24	EXL		82058
---------	-----	---------------	-------	---	---	---	----	-----	--	-------

### Delta

1.4	88	08/11 →	1.368	B	M	4	16	198A4.000	PIERBURG	81369
	88	08/11 →	1.368	B	M	4	16	198A4.000	TESMA	82070
1.4 16V	103	08/11 →	1.368	B	M	4	16	198A7.000	PIERBURG	81369
	103	08/11 →	1.368	B	M	4	16	198A7.000	TESMA	82070
1.6 D Multijet	88	08/11 →	1.598	D	M	4	16	198A2.000		81872
2.0 D Multijet	121	08/11 →	1.956	D	M	4	16	198A5.000		81872

### Grand Voyager V

2.8 CRD	120	10/07 →	2.768	D	M	4	16			84033 <b>NEW</b>
	120	10/07 →	2.777	D	M	4	16	ENS		84033 <b>NEW</b>
	132	09/12 →	2.777	D	M	4	16	ENS		84043 <b>NEW</b>



	KW		cm <sup>3</sup>				NO. OF VALVES		
--	----	--	-----------------	--	--	--	---------------	--	--

## CHRYSLER

### Neon I

1.8 16V	85	09/97 → 08/99	1.796	B	M	4	16	EBD		81733
2.0 16V	98	05/94 → 08/99	1.996	B	M	4	16	420H		81733
	107	06/94 → 08/99	1.996	B	M	4	16	ECC		81733
	109	04/96 → 08/99	1.996	B	M	4	16	420T		81733

### Neon II

1.6	85	11/01 → 12/06	1.598	B	M	4	16	EJD		81733
2.0 16V	98	08/99 → 12/06	1.996	B	M	4	16	420H, ECB		81733
2.0 16V R/T	110	10/01 → 12/06	1.996	B	M	4	16	ECH		81733

### PT Cruiser, Cabrio

1.6	85	11/01 → 12/10	1.598	B	M	4	16	EJD		81733
2.0	100	10/04 → 12/10	1.996	B	M	4	16	ECC		81733
	104	06/00 → 12/10	1.996	B	AM	4	16	ECC		81733

### Sebring II, Cabrio

2.0	104	04/01 → 06/07	1.996	B	M	4	16	ECC		81733
-----	-----	---------------	-------	---	---	---	----	-----	--	-------

### Sebring III, Cabrio

2.0 CRD	103	07/07 → 12/10	1.968	D	M	4	16	ECD		81816
	103	07/07 → 12/10	1.968	D	M	4	16	ECD		84011 <b>NEW</b>

### Stratus, Cabrio

2.0 16V	98	12/95 → 04/01	1.996	B	M	4	16	ECB		81733
2.0 LE	96	06/96 → 04/01	1.996	B	M	4	16	420X		81733
	96	12/95 → 04/01	1.996	B	M	4	16	C00		81733

### Voyager II

2.5 i	72	01/91 → 09/95	2.501	B	M	4	8	K00		81302
	74	08/90 → 09/95	2.501	B	M	4	8	K		81302
2.5 TD	87	01/92 → 09/95	2.500	D	M	4	8	09B, M00		81302

### Voyager III

2.0 i	98	01/95 → 03/01	1.995	B	M	4	16	C00		81733
2.5 TD	85	01/95 → 03/01	2.499	D	M	4	8	425CLIRS/X, ENC	(-)COP	81362

### Voyager IV

2.5 CRD	88	08/05 → 12/08	2.499	D	M	4	16	EDK		84033 <b>NEW</b>
	105	02/00 → 12/08	2.499	D	M	4	16	ENJ		84033 <b>NEW</b>
2.8 CRD	110	06/04 → 12/08	2.776	D	M	4	16	ENR		84033 <b>NEW</b>

### Ypsilon

0.9 Twinair	63	05/11 →	875	B	M	2	8	312A2.000		84008
1.2	51	05/11 →	1.242	B	M	4	8	169A4.000	PIERBURG	81369
	51	05/11 →	1.242	B	M	4	8	169A4.000	TESMA	82070
1.3 Multijet	70	05/11 →	1.248	D	M	4	16	199B1.000		81862

## CITROËN

### AX

1.4 4x4	62	09/86 → 07/92	1.360	B	M	4	8	K2A		81556
1.4 Allure	48	08/92 → 04/94	1.360	B	M	4	8	K1F		81513
1.4 D 4x4	39	06/91 → 07/92	1.360	D	M	4	8	K9A (TUD3)		81556

**KW**

**cm<sup>3</sup>**

**NO. OF VALVES**

**CITROËN**
**AX**

1.4 GTi	66	08/91 → 12/96	1.360	B	M	4	8	KFY (TU3FJ2)	08-1992 →	81513
	69	06/91 → 12/96	1.360	B	M	4	8	KFZ (TU3FJ2)	08-1992 →	81513
	74	06/91 → 12/92	1.360	B	M	4	8	KFZ (TU3FJ2)	→ PROD: 5.278	81556
	74	06/91 → 12/92	1.360	B	M	4	8	KFZ (TU3FJ2)	PROD →: 5.279	81513
10	32	09/86 → 06/92	954	B	M	4	8	C1A		81556
	33	07/86 → 12/98	954	B	M	4	8	CDY (TU9M)		81556
	37	02/87 → 12/98	954	B	M	4	8	CDZ (TU9M)		81556
11	40	12/86 → 04/94	1.124	B	M	4	8	H1A, H1B	12-1986 →	81556
	44	09/86 → 12/97	1.124	B	M	4	8	H1B, HDZ (TU1M)		81556
11 4x4	40	06/91 → 07/92	1.124	B	M	4	8	H1A		81556
14	55	04/87 → 04/97	1.360	B	M	4	8	KDX (TU3M/Z), KDY (TU3FM), KDY (TU3M), KDZ (TU3M/Z)	→ 12-1993	81556
	55	04/87 → 04/97	1.360	B	M	4	8	KDX (TU3M/Z), KDY (TU3FM), KDY (TU3M), KDZ (TU3M/Z)	08-1992 →	81513
	62	01/88 → 12/92	1.360	B	M	4	8	K2A, K2B		81556
14 4x4	55	08/91 → 12/96	1.360	B	M	4	8	KDX (TU3M/Z), KDY (TU3FM), KDY (TU3M), KDZ (TU3M/Z)	08-1992 →	81513
14 D	37	08/91 → 12/97	1.360	D	M	4	8	K9Y (TUD3Y)	01-1993 →	81556
	38	09/88 → 06/92	1.360	D	M	4	8	K9A (TUD3)		81556
15 D	40	08/94 → 12/97	1.527	D	M	4	8	VJY (TUD5)	05-1994 →	81513
	43	08/94 → 12/97	1.527	D	M	4	8	VJY (TUD5), VJZ (TUD5)		81513

**Berlingo I, Van**

1.1 i	44	07/96 →	1.124	B	M	4	8	HDZ (TU1M), HFX (TU1JP)	→ M: 3.762.433	81556
	44	07/96 →	1.124	B	M	4	8	HDZ (TU1M), HFX (TU1JP)	M →: 3.762.434	81797
1.4	48	11/02 →	1.360	G	M	4	8	KFW (TU3JP)		81797
	53	11/02 → 10/05	1.360	B	M	4	8	KFW (TU3JP)		81797
1.4 bivalent	48	11/02 →	1.360		M	4	8	KFW (TU3JP)		81797
1.4 GNC	48	11/02 →	1.360	G	M	4	8	KFW (TU3JP)		81797
1.4 Hybrid	54	05/05 →	1.360		M	4	8	KFW (TU3JP)		81797
1.4 i	55	07/96 →	1.360	B	M	4	8	KFW (TU3JP), KFX (TU3JP)	→ M: 3.666.765	81556
	55	07/96 →	1.360	B	M	4	8	KFW (TU3JP), KFX (TU3JP)	M →: 3.666.766	81797
1.4 i bivalent	55	04/03 →	1.360	BF	M	4	8	KFW (TU3JP)		81797

**KW**

**cm<sup>3</sup>**

**NO. OF VALVES**

**CITROËN**
**Berlingo I, Van**

1.6 16V	80	10/00 →	1.587	B	M	4	16	NFU (TU5JP4)		81753
	81	11/02 →	1.587	B	M	4	16	NFU (TU5JP4)		81753
1.6 HDI 110	80	08/05 →	1.560	D	M	4	16	9HZ (DV6TED4)		81869
1.6 HDI 75	55	07/05 →	1.560	D	M	4	16	9HW (DV6BTED4), DV6B		81869
1.6 HDI 90	66	07/05 →	1.560	D	M	4	16	9HX (DV6ATED4)		81869
1.8 D	43	07/96 →	1.769	D	M	4	8	A9A (XUD7)	07-1996 →	81642
	43	07/98 →	1.769	D	M	4	8	A9A (XUD7)		81642
1.8 i	66	08/99 → 10/02	1.761	B	M	4	8	LFX (XU7JB)		81512
	66	05/97 →	1.761	B	M	4	8	LFX (XU7JB)	01-1998 →	81512
1.8 i 4WD	66	04/97 →	1.761	B	M	4	8	LFX (XU7JB)	01-1998 →	81512
1.9 D	51	07/98 → 10/05	1.868	D	M	4	8	WJY (DW8B), WJZ (DW8)		81713
	50	07/96 →	1.905	D	M	4	8	D9B (XUD9A/L), DJY (XUD9A)	07-1996 →	81642
	51	07/96 → 10/99	1.905	D	M	4	8	DJY (XUD9A)		81642
	51	07/96 →	1.905	D	M	4	8	DJY (XUD9A)	07-1996 →	81642
1.9 D 4WD	51	07/98 →	1.868	D	M	4	8	WJY (DW8B), WJZ (DW8)		81713
1.9 D 70	51	04/99 →	1.868	D	M	4	8	WJY (DW8B), WJZ (DW8)		81713
1.9 D 70 4WD	51	07/98 →	1.868	D	M	4	8	WJY (DW8B), WJZ (DW8)		81713
2.0 HDi 4x4	66	11/02 → 10/05	1.997	D	M	4	8	RHY (DW10TD)		81713
2.0 HDi 90	66	12/99 →	1.997	D	M	4	8	RHY (DW10TD)		81713
2.0 HDi 90 4WD	66	11/00 →	1.997	D	M	4	8	RHY (DW10TD)		81713

**Berlingo II, Van**

1.6	66	04/08 →	1.587	B	M	4	16	NFR (TU5JP4B)		81753
	80	04/08 →	1.587	B	M	4	16	NFU (TU5JP4)		81753
1.6 BlueHDi 100	73	12/14 →	1.560	D	M	4	8	BHY (DV6FD)		81869
1.6 BlueHDi 120	88	12/14 →	1.560	D	M	4	8	BHZ (DV6FC)		81869
1.6 BlueHDi 75	55	04/15 →	1.560	D	M	4	8	9HN (DV6ETED), BHW (DV6FE)		81869
1.6 HDi 110	80	04/08 →	1.560	D	M	4	16	9HZ (DV6TED4)		81869
	82	07/10 →	1.560	D	M	4	8	9HL (DV6C), 9HR (DV6C)		81869
1.6 HDi 115	84	07/10 →	1.560	D	M	4	8	9HL (DV6C)		81869
	84	07/10 →	1.560	D	M	4	8	9HR (DV6C)		81869
1.6 HDi 75	55	04/08 →	1.560	D	M	4	16	9HT (DV6BTED4)		81869
	55	04/08 →	1.560	D	M	4	16	9HT (DV6BUTED4)		81869
1.6 HDi 90	66	07/10 →	1.560	D	M	4	8	9HF (DV6DTED)		81869
	66	04/08 →	1.560	D	M	4	16	9HX (DV6ATED4)		81869
	68	07/10 →	1.560	D	M	4	8	9HP (DV6DTED)		81869
	68	07/10 →	1.560	D	M	4	16	9HP (DV6DTED), 9HX (DV6ATED4)		81869
1.6 HDi 90 16V	66	04/08 →	1.560	D	M	4	16	9HS (DV6TED4BU), 9HX (DV6ATED4)		81869
1.6 VTi 120	88	11/09 →	1.598	B	M	4	16	5FS (EP6C)		82032
	88	11/09 →	1.598	B	M	4	16	5FS (EP6C)		81753

**KW**

**cm<sup>3</sup>**

**NO. OF VALVES**

**MAGNETI MARELLI**
**CITROËN**
**Berlingo II, Van**

1.6 VTi 95	72	07/10 →	1.598	B	M	4	16	5FK (EP6CB)		82032
------------	----	---------	-------	---	---	---	----	-------------	--	-------

**BX, Break**

1.6	85	01/87 → 01/92	1.580	B	M	4	8	B6D, B6E		81554
-----	----	---------------	-------	---	---	---	---	----------	--	-------

1.8 D	44	10/85 → 09/93	1.769	D	M	4	8	161 (XUD7)	→ 12-1986, → PROD: 3583	81554
-------	----	---------------	-------	---	---	---	---	------------	----------------------------	-------

	44	10/85 → 09/93	1.769	D	M	4	8	161 (XUD7)	01-1987 →, PROD →: 3584	81672
--	----	---------------	-------	---	---	---	---	------------	----------------------------	-------

1.9 DT TXD	66	02/92 → 12/94	1.905	D	M	4	8			81672
------------	----	---------------	-------	---	---	---	---	--	--	-------

1.9 GTi	117	01/90 → 01/92	1.905	B	M	4	8		→ PROD: 5409	81554
---------	-----	---------------	-------	---	---	---	---	--	--------------	-------

1.9 GTi 4x4	92	02/92 → 06/94	1.905	B	M	4	8		PROD →: 5410	81512
-------------	----	---------------	-------	---	---	---	---	--	--------------	-------

1.9 RD 4x4	52	01/87 → 01/92	1.905	D	M	4	8		PROD →: 3584	81672
------------	----	---------------	-------	---	---	---	---	--	--------------	-------

1.9 Tzi	92	02/92 → 12/94	1.905	B	M	4	8	D6A (XU9J2)	PROD →: 5410	81512
---------	----	---------------	-------	---	---	---	---	-------------	--------------	-------

11	40	10/88 → 06/92	1.124	B	M	4	8	HDZ (TU1M)	→ 09-1989, → PROD: 4192	81572
----	----	---------------	-------	---	---	---	---	------------	----------------------------	-------

	40	10/88 → 06/92	1.124	B	M	4	8	HDZ (TU1M)	10-1989 →, PROD →: 4193	81556
--	----	---------------	-------	---	---	---	---	------------	----------------------------	-------

	42	10/86 → 06/92	1.124	B	M	4	8	H1A	→ 09-1989, → PROD: 4192	81572
--	----	---------------	-------	---	---	---	---	-----	----------------------------	-------

	42	10/86 → 06/92	1.124	B	M	4	8	H1A	10-1989 →, PROD →: 4193	81556
--	----	---------------	-------	---	---	---	---	-----	----------------------------	-------

14	53	01/86 → 02/93	1.360	B	M	4	8	150C	→ 09-1989, → PROD: 4192	81572
----	----	---------------	-------	---	---	---	---	------	----------------------------	-------

	53	01/86 → 02/93	1.360	B	M	4	8	150C	02-1992 →, PROD →: 5440	81513
--	----	---------------	-------	---	---	---	---	------	----------------------------	-------

	53	01/86 → 02/93	1.360	B	M	4	8	150C	10-1989 →, → 01-1992, PROD →: 4193, → PROD: 5440	81556
--	----	---------------	-------	---	---	---	---	------	---	-------

	55	01/89 → 02/93	1.360	B	M	4	8	KDY (TU3M)	→ 09-1989, → PROD: 4192	81572
--	----	---------------	-------	---	---	---	---	------------	----------------------------	-------

	55	01/89 → 02/93	1.360	B	M	4	8	KDY (TU3M)	02-1992 →, PROD →: 5440	81513
--	----	---------------	-------	---	---	---	---	------------	----------------------------	-------

	55	01/89 → 02/93	1.360	B	M	4	8	KDY (TU3M)	10-1989 →, → 01-1992, PROD →: 4193, → PROD: 5440	81556
--	----	---------------	-------	---	---	---	---	------------	---	-------

	55	01/89 → 02/93	1.360	B	M	4	8	KDY (TU3M), KDZ (TU3M/Z)	→ 09-1989, → PROD: 4192	81572
--	----	---------------	-------	---	---	---	---	-----------------------------	----------------------------	-------

	55	01/89 → 02/93	1.360	B	M	4	8	KDY (TU3M), KDZ (TU3M/Z)	02-1992 →, PROD →: 5440	81513
--	----	---------------	-------	---	---	---	---	-----------------------------	----------------------------	-------

	55	01/89 → 02/93	1.360	B	M	4	8	KDY (TU3M), KDZ (TU3M/Z)	10-1989 →, → 01-1992, PROD →: 4193, → PROD: 5440	81556
--	----	---------------	-------	---	---	---	---	-----------------------------	---	-------

	55	01/89 → 02/93	1.360	B	M	4	8	KDY (TU3M), KDZ (TU3M/Z)	→ 09-1989, → PROD: 4192	81572
--	----	---------------	-------	---	---	---	---	-----------------------------	----------------------------	-------

	55	01/89 → 02/93	1.360	B	M	4	8	KDY (TU3M), KDZ (TU3M/Z)	02-1992 →, PROD →: 5440	81513
--	----	---------------	-------	---	---	---	---	-----------------------------	----------------------------	-------

	55	01/89 → 02/93	1.360	B	M	4	8	KDY (TU3M), KDZ (TU3M/Z)	10-1989 →, → 01-1992, PROD →: 4193, → PROD: 5440	81556
--	----	---------------	-------	---	---	---	---	-----------------------------	---	-------

**KW**

**cm<sup>3</sup>**

**NO. OF VALVES**

**CITROËN**
**BX, Break**

14 E	49	09/85 → 02/93	1.360	B	M	4	8	150F	→ 09-1989, → PROD: 4192	81572
	49	09/85 → 02/93	1.360	B	M	4	8	150F	02-1992 →, PROD →: 5440	81513
	49	09/85 → 02/93	1.360	B	M	4	8	150F	10-1989 →, → 01-1992, PROD →: 4193, → PROD: 5440	81556
	53	04/83 → 02/93	1.360	B	M	4	8	150C	→ 09-1989, → PROD: 4192	81572
	53	04/83 → 02/93	1.360	B	M	4	8	150C	02-1992 →, PROD →: 5440	81513
	53	04/83 → 02/93	1.360	B	M	4	8	150C	10-1989 →, → 01-1992, PROD →: 4193, → PROD: 5440	81556
15	59	10/87 → 05/92	1.580	B	M	4	8	B1E (XU51C)		81512
16	53	01/87 → 02/93	1.580	B	M	4	8	B1E (XU51C)	→ 01-1992, → PROD: 5409	81554
	53	01/87 → 02/93	1.580	B	M	4	8	B1E (XU51C)	02-1992 →, PROD →: 5410	81512
	55	09/88 → 02/93	1.580	B	M	4	8	BAY (XU5CP), BAZ (XU5CP)	→ 01-1992, → PROD: 5409	81554
	55	09/88 → 02/93	1.580	B	M	4	8	BAY (XU5CP), BAZ (XU5CP)	02-1992 →, PROD →: 5410	81512
	58	09/87 → 02/93	1.580	B	M	4	8	B1A (XU51C/K)	→ 01-1992, → PROD: 5409	81554
	58	09/87 → 02/93	1.580	B	M	4	8	B1A (XU51C/K)	02-1992 →, PROD →: 5410	81512
	64	07/85 → 02/93	1.580	B	M	4	8	171D	→ 01-1992, → PROD: 5409	81554
	64	07/85 → 02/93	1.580	B	M	4	8	171D	02-1992 →, PROD →: 5410	81512
	65	05/89 → 12/94	1.580	B	M	4	8	BDY (XU5M), BDZ (XU5M)	→ 01-1992, → PROD: 5409	81554
	65	05/89 → 12/94	1.580	B	M	4	8	BDY (XU5M), BDZ (XU5M)	02-1992 →, PROD →: 5410	81512
	68	10/82 → 12/92	1.580	B	M	4	8	XU52C	→ 01-1992, → PROD: 5409	81554
	68	10/82 → 12/92	1.580	B	M	4	8	XU52C	02-1992 →, PROD →: 5410	81512
76	03/86 → 02/93	1.580	B	M	4	8	180Z	→ 01-1992, → PROD: 5409	81554	
76	03/86 → 02/93	1.580	B	M	4	8	180Z	02-1992 →, PROD →: 5410	81512	

**KW**

**cm<sup>3</sup>**

**NO. OF VALVES**

**MAGNETI MARELLI**
**CITROËN**
**BX, Break**

16 E	65	05/89 → 02/93	1.580	B	M	4	8	BDY (XU5M), BDZ (XU5M)	→ 01-1992, → PROD: 5409	<b>81554</b>
	65	05/89 → 02/93	1.580	B	M	4	8	BDY (XU5M), BDZ (XU5M)	02-1992 →, PROD →: 5410	<b>81512</b>
18 D	44	10/85 → 09/93	1.769	D	M	4	8	161A (XUD7)	→ 12-1986, → PROD: 3583	<b>81554</b>
	44	10/85 → 09/93	1.769	D	M	4	8	161A (XUD7)	01-1987 →, PROD →: 3584	<b>81672</b>
19	75	07/86 → 12/94	1.905	B	M	4	8	D2A (XU92C)	→ 01-1992, → PROD: 5409	<b>81554</b>
	75	07/86 → 12/94	1.905	B	M	4	8	D2A (XU92C)	02-1992 →, PROD →: 5410	<b>81512</b>
	80	06/88 → 12/94	1.905	B	M	4	8	DDZ (XU9M)	→ 01-1992, → PROD: 5409	<b>81554</b>
	80	06/88 → 12/94	1.905	B	M	4	8	DDZ (XU9M)	02-1992 →, PROD →: 5410	<b>81512</b>
	88	06/88 → 12/94	1.905	B	M	4	8	DKZ (XU9JA)	→ 01-1992, → PROD: 5409	<b>81554</b>
	88	06/88 → 12/94	1.905	B	M	4	8	DKZ (XU9JA)	02-1992 →, PROD →: 5410	<b>81512</b>
19 4x4	80	10/90 → 05/91	1.905	B	M	4	8	DDZ (XU9M)	→ PROD: 5.409	<b>81554</b>
19 Cat.	75	07/86 → 12/94	1.905	B	M	4	8	DFZ (XU9J1)	→ 01-1992, → PROD: 5409	<b>81554</b>
	75	07/86 → 12/94	1.905	B	M	4	8	DFZ (XU9J1)	02-1992 →, PROD →: 5410	<b>81512</b>
19 D	47	09/83 → 09/93	1.905	D	M	4	8	162 (XUD9), D9A (XUD9), DJZ (XUD9Y)	→ 12-1986, → PROD: 3583	<b>81554</b>
	47	09/83 → 09/93	1.905	D	M	4	8	162 (XUD9), D9A (XUD9), DJZ (XUD9Y)	01-1987 →, PROD →: 3584	<b>81672</b>
	51	03/87 → 02/93	1.905	D	M	4	8	D9B (XUD9A/U)	PROD →: 3584	<b>81672</b>
19 E	80	06/88 → 02/93	1.905	B	M	4	8	DDZ (XU9M)	→ 01-1992, → PROD: 5409	<b>81554</b>
	80	06/88 → 02/93	1.905	B	M	4	8	DDZ (XU9M)	02-1992 →, PROD →: 5410	<b>81512</b>
19 E 4x4	80	04/89 → 02/93	1.905	B	M	4	8	D2F	→ 01-1992, → PROD: 5409	<b>81554</b>
	80	04/89 → 02/93	1.905	B	M	4	8	D2F	02-1992 →, PROD →: 5410	<b>81512</b>

--	--	--	--	--	--	--	--	--	--

## CITROËN

### BX, Break

19 GTi	88	06/88 → 02/93	1.905	B	M	4	8	DKZ (XU9JA)	→ 01-1992, → PROD: 5409	81554
	88	06/88 → 02/93	1.905	B	M	4	8	DKZ (XU9JA)	02-1992 →, PROD →: 5410	81512
	90	07/86 → 02/93	1.905	B	M	4	8	D6A (XU9J2)	→ 01-1992, → PROD: 5409	81554
	90	07/86 → 02/93	1.905	B	M	4	8	D6A (XU9J2)	02-1992 →, PROD →: 5410	81512
19 GTi 16V	108	03/88 → 02/93	1.905	B	M	4	16	DFW (XU9J4)	→ 01-1992, → PROD: 5409	81554
	108	03/88 → 02/93	1.905	B	M	4	16	DFW (XU9J4)	02-1992 →, PROD →: 5410	81512
19 GTi 4x4	88	06/88 → 02/93	1.905	B	M	4	8	DKZ (XU9JA)	→ 01-1992, → PROD: 5409	81554
	88	06/88 → 02/93	1.905	B	M	4	8	DKZ (XU9JA)	02-1992 →, PROD →: 5410	81512
TRD Turbo	66	03/88 → 02/93	1.769	D	M	4	8	A8A (XUD7TE), AJZ (XUD7TE)		81672
	66	03/88 → 12/94	1.769	D	M	4	8	A8A (XUD7TE), AJZ (XUD7TE)	PROD →: 3584	81672
<b>C 1 I</b>										
1.0	50	06/05 →	998	B	M	3	12	1KR-FE		82063
1.4 HDi	40	06/05 →	1.398	D	M	4	8	8HT (DV4TD)		81798
<b>C 1 II</b>										
1.0 VTi 68	51	04/14 →	998	B	M	3	12	1KR-FE		84054
1.2 VTi 82	60	04/14 →	1.199	B	M	3	12	HMT (EB2D)		84066
<b>C 15</b>										
1.0	33	10/84 → 12/97	954	B	M	4	8	TU9, XV8	→ 12-1988, → PROD: 4192	81572
	33	10/84 → 12/97	954	B	M	4	8	TU9, XV8	01-1989 →, PROD →: 4193	81556
1.0 E	37	11/92 → 07/96	954	B	M	4	8	TU9K	→ PROD: 4192	81572
	37	11/92 → 07/96	954	B	M	4	8	TU9K	PROD →: 4193	81556
1.1	35	10/84 → 12/96	1.124	B	M	4	8	109K, E1A	→ 12-1988, → PROD: 4237	81560
	35	10/84 → 12/96	1.124	B	M	4	8	109K, E1A	→ PROD: 4192	81572
	35	10/84 → 12/96	1.124	B	M	4	8	109K, E1A	01-1989 →, PROD →: 4193	81556
	40	11/88 → 07/96	1.124	B	M	4	8	H1A		81556
1.1 i	44	07/88 → 12/96	1.124	B	M	4	8	HDZ (TU1M)		81556
1.4	49	07/87 → 12/96	1.360	B	M	4	8	K1H (TU3A)	→ PROD: 4192	81572
	49	07/87 → 12/96	1.360	B	M	4	8	K1H (TU3A)	PROD →: 4193	81556

**KW**

**cm<sup>3</sup>**

**NO. OF VALVES**

**CITROËN**
**C 15**

1.4 E	40	07/87 → 12/96	1.360	B	M	4	8	K3A	→ PROD: 4192	81572
	40	07/87 → 12/96	1.360	B	M	4	8	K3A	PROD →: 4193	81556
	44	05/87 → 12/96	1.360	B	M	4	8	150D (XY7)	→ PROD: 4192	81572
	44	05/87 → 12/96	1.360	B	M	4	8	150D (XY7)	PROD →: 4193	81556
1.4 i	55	05/91 → 12/96	1.360	B	M	4	8	KDY (TU3FM), KDY (TU3M)	→ PROD: 4192	81572
	55	05/91 → 12/96	1.360	B	M	4	8	KDY (TU3FM), KDY (TU3M)	PROD →: 4193	81556
1.8 D	44	07/86 → 12/00	1.769	D	M	4	8	161A (XUD7)	→ PROD: 3583	81554
	44	07/86 → 12/00	1.769	D	M	4	8	161A (XUD7)	PROD →: 3584, → PROD: 6264	81672
	44	07/86 → 12/00	1.769	D	M	4	8	161A (XUD7)	PROD →: 6265	81642
1.9 D	44	12/00 → 12/05	1.868	D	M	4	8	WJX (DW8B)		81713

**C 2, Van**

1.1	44	09/03 →	1.124	B	M	4	8	HFX (TU1JP)		81797
1.4	54	09/03 →	1.360	B	M	4	8	KFV (TU3JP)		81797
	55	10/06 →	1.360	B	M	4	8	KFV (TU3JP)		81797
1.4 16V	65	06/06 →	1.360	B	M	4	16	KFU (ET3J4)		82016
1.4 HDi	50	04/09 →	1.398	D	M	4	8	8HX (DV4TD)		81798
	50	09/03 →	1.398	D	M	4	8	8HX (DV4TD), 8HZ (DV4TD)		81798
1.6	80	09/03 →	1.587	B	M	4	16	NFU (TU5JP4)		81753
1.6 HDi	80	09/05 →	1.560	D	M	4	16	9HZ (DV6TED4)		81869
1.6 VTS	90	01/05 →	1.587	B	M	4	16	NFS (TU5JP4S)		81753

**C 25**

1.8	50	11/81 → 01/94	1.796	B	M	4	8	169 (XM7T)		81367
1.8 E	51	07/87 → 02/94	1.796	B	M	4	8	169 (XM7T)		81367
1.9 D	51	07/87 → 02/94	1.905	D	M	4	8	D9B (XUD9A/U)	(-)AC	81822
1.9 D 1400	51	01/88 → 01/94	1.905	D	M	4	8	DJY (XUD9A)	(-)AC	81822
1.9 TD	60	04/92 → 02/94	1.930	D	M	4	8	M705	(-)AC	81822
2.0	62	02/91 → 02/94	1.971	B	M	4	8	170C (XN1T)		81367
2.0 4x4	62	01/90 → 01/94	1.971	B	M	4	8			81367
2.0 E	58	09/81 → 02/94	1.971	B	M	4	8	170A (XN1T), 170B (XN1T)		81367
2.5 D	54	10/85 → 02/94	2.500	D	M	4	8	CRD93L (U25-661)	(-)AC	81822
2.5 D 4x4	54	01/87 → 02/94	2.500	D	M	4	8	CRD93L (U25-661)	(-)AC	81822
2.5 D Turbo	70	08/87 → 02/94	2.500	D	M	4	8	CRD93LS (U25-673)	(-)AC	81822
2.5 D Turbo 4x4	70	08/87 → 02/94	2.500	D	M	4	8	CRD93LS (U25-673)	(-)AC	81822
2.5 DT	70	01/87 → 01/94	2.498	D	M	4	8	CRD93LS (U25-673)	(-)AC	81822

**C 3 I, Pluriel**

1.1 i	44	02/02 →	1.124	B	M	4	8	HFX (TU1A), HFX (TU1JP)		81797
1.4	54	05/03 →	1.360	B	M	4	8	KFV (TU3JP)		81797
1.4 16V	65	12/03 →	1.360	B	M	4	16	KFU (ET3J4)		82016



		<b>KW</b>		<b>cm<sup>3</sup></b>				<b>NO. OF VALVES</b>		
--	--	-----------	--	-----------------------	--	--	--	----------------------	--	--

## CITROËN

### C 3 I, Pluriel

1.4 16V HDi	66	02/02 →	1.398	D	M	4	16	8HY (DV4TED4)		81798
1.4 HDi	50	02/02 →	1.398	D	M	4	8	8HX (DV4TD)		81798
1.4 HDi	55	05/05 →	1.398	D	M	4	8	8HX (DV4TD)		81798
1.4 Hybrid	54	05/05 →	1.360		M	4	8	KFV (TU3JP)		81797
1.4 i	54	02/02 →	1.360	B	AM	4	8	KFV (TU3A), KFV (TU3JP)		81797
1.4 i Bivalent	54	02/02 →	1.360		AM	4	8	KFV (TU3JP)		81797
1.6	80	05/03 →	1.587	B	M	4	16	NFU (TU5JP4)		81753
1.6 16V	80	02/02 →	1.587	B	M	4	16	NFU (TU5JP4)		81753
	81	05/03 → 09/05	1.587	B	M	4	16	NFU (TU5JP4)		81753
1.6 16V HDi	66	10/05 →	1.560	D	M	4	16	9HX (DV6ATED4)		81869
	80	09/05 →	1.560	D	M	4	16	9HZ (DV6TED4)		81869

### C 3 II, Picasso

1.0 VTi 68	50	08/12 →	999	B	M	3	12	ZMZ (EB0)		84066 <b>NEW</b>
1.1	44	11/09 →	1.124	B	M	4	8	HFX (TU1JP)		81797
1.1 BiFuel	44	11/10 →	1.124	BF	M	4	8	HFX (TU1A)		81797
1.2 THP 110	81	10/14 →	1.199	B	M	3	12	HNZ (EB2DT)		84066 <b>NEW</b>
1.2 VTi 82	60	06/12 →	1.199	B	M	3	12	HMZ (EB2F)		84066 <b>NEW</b>
1.4	54	11/09 →	1.360	B	M	4	8	KFT (TU3A), KFV (TU3A)		81797
1.4 HDi 70	50	11/09 →	1.398	D	M	4	8	8HR (DV4C), 8HZ (DV4TD)		81798
1.4 LPG	70	06/13 →	1.397		M	4	16	8FN (EP3)		82032
1.4 VTi	72	11/09 →	1.397	B	M	4	16	8FR (EP3)		82032
1.4 VTi 95	70	02/09 →	1.397	B	M	4	16	8FN (EP3), 8FP (EP3), 8FS (EP3)		82032
	70	11/09 →	1.397	B	M	4	16	8FP (EP3)		82032
1.4 VTi 95 LPG	70	01/12 →	1.397		M	4	16	8FN (EP3)		82032
1.6 BlueHDi 100	73	07/14 →	1.560	D	M	4	8	BHY (DV6FD)		81869
1.6 BlueHDi 75	55	04/15 →	1.560	D	M	4	8	BHW (DV6FE)		81869
1.6 HDi	66	02/09 →	1.560	D	M	4	16	9HX (DV6ATED4)		81869
	68	11/09 →	1.560	D	M	4	8	9HP (DV6DTED)		81869
	80	02/09 →	1.560	D	M	4	16	9HZ (DV6TED4)		81869
1.6 HDi 110	82	11/09 →	1.560	D	M	4	8	9HR (DV6C)		81869
1.6 HDi 115	84	09/12 →	1.560	D	M	4	8	9HD (DV6C)		81869
1.6 HDi 90	66	11/09 →	1.560	D	M	4	16	9HX (DV6ATED4)		81869
	68	07/10 →	1.560	D	M	4	8	9HP (DV6DTED)		81869
1.6 VTi 120	88	11/09 →	1.598	B	M	4	16	5FS (EP6C)		82032
	88	02/09 →	1.598	B	M	4	16	5FS (EP6C), 5FW (EP6)		82032

### C 4 Cactus

1.2 THP 110	81	09/14 →	1.199	B	M	3	12	HNZ (EB2DT)		84066 <b>NEW</b>
1.2 VTi 75	55	09/14 →	1.199	B	M	3	12	HMU (EB2D)		84066 <b>NEW</b>
1.2 VTi 82	60	09/14 →	1.199	B	M	3	12	HMZ (EB2F)		84066 <b>NEW</b>
1.6 BlueHDi 100	73	09/14 →	1.560	D	M	4	8	BHY (DV6FD)		81869
1.6 HDi 90	68	09/14 →	1.560	D	M	4	8	9HP (DV6DTED)		81869

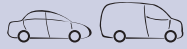
**KW**

**cm<sup>3</sup>**

**NO. OF VALVES**

**MAGNETI MARELLI**
**CITROËN**
**C 4 Aircross**

1.6	86	04/12 →	1.590	B	M	4	16	4A92		82049
1.6 HDi 115	84	04/12 →	1.560	D	M	4	8	9HL (DV6C)		81869
1.6 HDi 115 AWC	84	05/12 →	1.560	D	M	4	8	9HL (DV6C)		81869
1.8 HDi 150	110	04/12 →	1.798	D	M	4	16	4N13		84042 <b>NEW</b>
1.8 HDi 150 AWC	110	04/12 →	1.798	D	M	4	16	4N13		84042 <b>NEW</b>

**C 4 I, Coupé, Picasso, Grand Picasso**

1.4 16V	65	11/04 → 07/11	1.360	B	M	4	16	KFU (ET3J4)		82016
1.6 16V	80	11/04 → 07/11	1.587	B	M	4	16	NFU (TU5JP4)		81753
	103	07/08 →	1.598	B	M	4	16	5FT (EP6DT)		82032
	110	10/08 →	1.598	B	M	4	16	5FX (EP6DT)		82032
1.6 16V Bio-Flex	80	09/07 → 07/08	1.587		M	4	16	NFU (TU5JP4)		81753
1.6 HDi	66	11/04 → 07/11	1.560	D	M	4	16	9HX (DV6ATED4)		81869
	80	11/04 → 07/11	1.560	D	M	4	16	9HY (DV6TED4), 9HZ (DV6TED4)		81869
1.6 HDi 110	82	09/10 →	1.560	D	M	4	8	9HL (DV6C), 9HR (DV6C)		81869
	82	09/10 → 08/13	1.560	D	M	4	8	9HR (DV6C)		81869
1.6 THP 140	103	07/08 → 07/11	1.598	B	M	4	16	5FT (EP6DT)		82032
1.6 THP 150	110	07/08 → 07/11	1.598	B	M	4	16	5FX (EP6DT)		82032
1.6 THP 155	115	09/10 →	1.598	B	M	4	16	5FV (EP6CDT)		82032
1.6 VTi 120	88	07/08 → 07/11	1.598	B	M	4	16	5FW (EP6)		82032
1.8 Bifuel	92	01/09 → 10/12	1.749	BF	M	4	16	6FY (EW7A)	(-)COP	84038 <b>NEW</b>
	92	01/09 → 10/12	1.749	BF	M	4	16	6FY (EW7A)	(+)COP	82089
	92	01/09 → 10/12	1.749	BF	M	4	16	6FY (EW7A)		82089
	92	01/09 → 10/12	1.749	BF	M	4	16	6FY (EW7A)		81799
1.8 i 16V	92	10/06 →	1.749	B	M	4	16	6FY (EW7A)	(-)COP	84038 <b>NEW</b>
	92	10/06 →	1.749	B	M	4	16	6FY (EW7A)	(+)COP	82089
	92	10/06 →	1.749	B	M	4	16	6FY (EW7A)		82089
	92	10/06 →	1.749	B	M	4	16	6FY (EW7A)		81799
2.0 16V	100	11/04 → 07/07	1.997	B	M	4	16	RFN (EW10J4)	(-)COP	84038 <b>NEW</b>
	100	11/04 → 07/07	1.997	B	M	4	16	RFN (EW10J4)	(+)COP	82089
	100	11/04 → 07/07	1.997	B	M	4	16	RFN (EW10J4)		82089
	100	11/04 → 07/07	1.997	B	M	4	16	RFN (EW10J4)		81799
	103	11/04 → 07/11	1.997	B	M	4	16	RFJ (EW10A)	(-)COP	84038 <b>NEW</b>
	103	11/04 → 07/11	1.997	B	M	4	16	RFJ (EW10A)	(+)COP	82089
	103	11/04 → 07/11	1.997	B	M	4	16	RFJ (EW10A)		82089
	103	11/04 → 07/11	1.997	B	M	4	16	RFJ (EW10A)		81799
	130	11/04 → 12/10	1.997	B	M	4	16	RFK (EW10J4S)	(-)COP	84038 <b>NEW</b>
	130	11/04 → 12/10	1.997	B	M	4	16	RFK (EW10J4S)	(+)COP	82089
	130	11/04 → 12/10	1.997	B	M	4	16	RFK (EW10J4S)		82089
2.0 HDi	81	04/07 → 07/08	1.997	D	M	4	8	RHZ (DW10ATED)		81713
	100	11/04 → 12/10	1.997	D	M	4	16	RHR (DW10BTED4)		81800
	103	07/08 → 07/11	1.997	D	M	4	16	RHF (DW10BTED4)		81800



## CITROËN

### C 4 I, Coupé, Picasso, Grand Picasso

2.0 HDi 138	100	10/06 →	1.997	D	M	4	16	RHJ (DW10BTED4), RHR (DW10BTED4)		81800	
2.0 HDi 150	110	07/09 →	1.997	D	M	4	16	RHE (DW10CTED4)		84020	<b>NEW</b>
2.0 HDi 165	120	09/10 →	1.997	D	M	4	16	RHH (DW10CTED4)		84020	<b>NEW</b>
2.0 i 16V	103	10/06 →	1.997	B	M	4	16	RFJ (EW10A)	(-)COP	84038	<b>NEW</b>
	103	10/06 →	1.997	B	M	4	16	RFJ (EW10A)	(+)COP	82089	
	103	10/06 →	1.997	B	M	4	16	RFJ (EW10A)		82089	
	103	10/06 →	1.997	B	M	4	16	RFJ (EW10A)		81799	
2.0 VTR	103	10/06 → 12/07	1.997	B	M	4	16	RFJ (EW10A)	(-)COP	84038	<b>NEW</b>
	103	10/06 → 12/07	1.997	B	M	4	16	RFJ (EW10A)	(+)COP	82089	

### C 4 II, Picasso, Grand Picasso

1.2 THP 110	81	02/15 →	1.199	B	M	3	12	HNZ (EB2DT)		84066	<b>NEW</b>
1.2 THP 130	96	04/14 →	1.199	B	M	3	12	HNY (EB2DTS)		84066	<b>NEW</b>
1.4 VTi 95	70	11/09 →	1.397	B	M	4	16	8FP (EP3)		82032	
1.6 BlueHDi 100	73	01/15 →	1.560	D	M	4	8	BHY (DV6FD)		81869	
1.6 BlueHDi 115	85	08/14 →	1.560	D	M	4	8	BHX (DV6FC)		81869	
1.6 BlueHDi 120	88	07/14 →	1.560	D	M	4	8	BHZ (DV6FC)		81869	
1.6 HDi / BlueHDi 115	85	09/13 →	1.560	D	M	4	8	9HC (DV6C), BHX (DV6FC)		81869	
1.6 HDi 110	82	11/09 →	1.560	D	M	4	8	9HR (DV6C)		81869	
1.6 HDi 115	84	07/12 →	1.560	D	M	4	8	9HD (DV6C), 9HR (DV6C)		81869	
1.6 HDi 90	68	09/13 →	1.560	D	M	4	8	9HP (DV6DTED)		81869	
1.6 THP 155	115	09/13 →	1.598	B	M	4	16	5FV (EP6CDT)		82032	
1.6 THP 165	121	07/14 →	1.598	B	M	4	16	5GZ (EP6FDT)		82032	
1.6 VTi 120	88	09/13 →	1.598	B	M	4	16	5FS (EP6C)		82032	
1.6 VTi 120 LPG	88	09/11 →	1.598		M	4	16	5FS (EP6C)		82032	
2.0 BlueHDi 135	100	09/13 →	1.997	D	M	4	16	AHV (DW10FDD)		82068	
2.0 BlueHDi 150	110	09/13 →	1.997	D	M	4	16	AHX (DW10FD)		82068	
	110	11/09 →	1.997	D	M	4	16	RHE (DW10CTED4)		84020	<b>NEW</b>

### C 5 I, Break

1.8 16V	85	03/01 → 08/04	1.749	B	M	4	16	6FZ (EW7J4)	(-)COP	84038	<b>NEW</b>
	85	03/01 → 08/04	1.749	B	M	4	16	6FZ (EW7J4)	(+)COP	82089	
	85	03/01 → 08/04	1.749	B	M	4	16	6FZ (EW7J4)		82089	
	85	03/01 → 08/04	1.749	B	M	4	16	6FZ (EW7J4)		81799	
2.0 16V	100	03/01 → 08/04	1.997	B	M	4	16	RFN (EW10J4)	(-)COP	84038	<b>NEW</b>
	100	03/01 → 08/04	1.997	B	M	4	16	RFN (EW10J4)	(+)COP	82089	
	100	03/01 → 08/04	1.997	B	M	4	16	RFN (EW10J4)		82089	
	100	03/01 → 08/04	1.997	B	M	4	16	RFN (EW10J4)		81799	
2.0 16V HPi	103	03/01 → 08/04	1.997	B	M	4	16	RLZ (EW10D)	(-)COP	84038	<b>NEW</b>
	103	03/01 → 08/04	1.997	B	M	4	16	RLZ (EW10D)	(+)COP	82089	
	103	03/01 → 08/04	1.997	B	M	4	16	RLZ (EW10D)		82089	
	103	03/01 → 08/04	1.997	B	M	4	16	RLZ (EW10D)		81799	

**KW**

**cm<sup>3</sup>**

**NO. OF VALVES**

**MAGNETI MARELLI**
**CITROËN**
**C 5 I, Break**

2.0 HDi	79	03/01 → 08/04	1.997	D	M	4	8	RHS (DW10ATED), RHZ (DW10ATED)		81713
	80	06/01 → 08/04	1.997	D	M	4	8	RHZ (DW10ATED)		81713
	66	03/01 → 08/04	1.997	D	M	4	8	RHY (DW10TD)		81713
	79	06/01 → 08/04	1.997	D	M	4	8	RHS (DW10ATED), RHZ (DW10ATED)		81713
	80	03/01 → 08/04	1.997	D	M	4	8	RHZ (DW10ATED)		81713
2.2 HDi	98	03/01 → 08/04	2.179	D	M	4	16	4HX (DW12TED4/FAP)		81800
3.0 Carlsson	173	09/03 → 08/04	2.946	B	M	6	24	XFJ (ES9J4S)		81813
3.0 V6	152	03/01 → 08/04	2.946	B	AM	6	24	XFJ (ES9J4S)		81813

**C 5 II, Break**

1.6 HDi	80	09/04 →	1.560	D	M	4	16	9HY (DV6TED4), 9HZ (DV6TED4)		81869
1.8 16V	92	09/05 →	1.749	B	M	4	16	6FY (EW7A)	(-)COP	84038 <b>NEW</b>
	92	09/05 →	1.749	B	M	4	16	6FY (EW7A)	(+)COP	82089
	92	09/05 →	1.749	B	M	4	16	6FY (EW7A)		82089
	92	09/05 →	1.749	B	M	4	16	6FY (EW7A)		81799
	85	09/04 →	1.749	B	M	4	16	6FZ (EW7J4)	(-)COP	84038 <b>NEW</b>
	85	09/04 →	1.749	B	M	4	16	6FZ (EW7J4)	(+)COP	82089
	85	09/04 →	1.749	B	M	4	16	6FZ (EW7J4)		82089
2.0 16V	103	09/04 →	1.997	B	M	4	16	RFJ (EW10A)	(-)COP	84038 <b>NEW</b>
	103	09/04 →	1.997	B	M	4	16	RFJ (EW10A)	(+)COP	82089
	103	09/04 →	1.997	B	M	4	16	RFJ (EW10A)		82089
	103	09/04 →	1.997	B	M	4	16	RFJ (EW10A)		81799
2.0 HDi	100	09/04 →	1.997	D	M	4	16	RHR (DW10BTED4)		81800
2.2 HDi	120	05/06 →	2.179	D	M	4	16	4HP (DW12BTED4), 4HR (DW12BTED4)		82068
	125	04/06 →	2.179	D	M	4	16	4HT (DW12BTED4)		82068
	98	09/04 →	2.179	D	M	4	16	4HX (DW12TED4/FAP)		81800
3.0	173	09/04 →	2.946	B	M	6	24	XFJ (ES9J4S)		81813
3.0 V6	155	10/04 → 04/07	2.946	B	M	6	24	XFU (ES9A)		81813
	152	09/04 →	2.946	B	M	6	24	XFU (ES9A)		81813
	152	09/04 →	2.946	B	M	6	24	XFU (ES9A), XFJ (ES9J4S)		81813

**C 5 III, Break**

1.6 HDi	80	02/08 →	1.560	D	M	4	16	9HZ (DV6TED4)		81869
1.6 HDi 110	82	07/10 →	1.560	D	M	4	8	9HL (DV6C), 9HR (DV6C)		81869
1.6 HDi 115	84	01/12 →	1.560	D	M	4	8	9HL (DV6C), 9HR (DV6C)		81869
1.6 THP 150	110	07/10 →	1.598	B	M	4	16	5FN (EP6CDT)		82032
1.6 THP 155	115	04/09 →	1.598	B	M	4	16	5FV (EP6CDT)		82032
1.6 VTi 120	88	07/10 →	1.598	B	M	4	16	5FS (EP6C)		82032

--	--	--	--	--	--	--	--	--

## CITROËN

### C 5 III, Break

1.8 16V	92	02/08 →	1.749	B	M	4	16	6FY (EW7A)	(-)COP	84038	<b>NEW</b>
	92	02/08 →	1.749	B	M	4	16	6FY (EW7A)	(+)COP	82089	
	92	02/08 →	1.749	B	M	4	16	6FY (EW7A)		82089	
	92	02/08 →	1.749	B	M	4	16	6FY (EW7A)		81799	
2.0 16V	103	02/08 →	1.997	B	M	4	16	RFJ (EW10A)	(-)COP	84038	<b>NEW</b>
	103	02/08 →	1.997	B	M	4	16	RFJ (EW10A)	(+)COP	82089	
	103	02/08 →	1.997	B	M	4	16	RFJ (EW10A)		82089	
	103	02/08 →	1.997	B	M	4	16	RFJ (EW10A)		81799	
2.0 16V BioFlex	103	02/08 →	1.997		M	4	16	RFJ (EW10A)	(-)COP	84038	<b>NEW</b>
	103	02/08 →	1.997		M	4	16	RFJ (EW10A)	(+)COP	82089	
	103	02/08 →	1.997		M	4	16	RFJ (EW10A)		82089	
	103	02/08 →	1.997		M	4	16	RFJ (EW10A)		81799	
2.0 HDi	100	02/08 →	1.997	D	M	4	16	RHF (DW10BTED4), RHR (DW10BTED4)		81800	
	100	02/08 →	1.997	D	M	4	16	RHR (DW10BTED4)		81800	
2.0 HDi 140	103	04/09 →	1.997	D	M	4	16	RHF (DW10BTED4)		81800	
2.0 HDi 150 / BlueHDi 150	110	04/09 →	1.997	D	M	4	16	AHR (DW10FD), RHE (DW10CTED4)	M: DW10CTED4	84020	<b>NEW</b>
	110	04/09 →	1.997	D	M	4	16	AHR (DW10FD), RHE (DW10CTED4)		82068	
2.0 HDi 165	120	04/09 →	1.997	D	M	4	16	RHH (DW10CTED4)		84020	<b>NEW</b>
	120	04/09 →	1.997	D	M	4	16	RHH (DW10CTED4)		81800	
2.0 HDi 180	133	03/15 →	1.997	D	M	4	16	AHW (DW10FC)		82068	
2.2 HDi	125	02/08 →	2.179	D	M	4	16	4HT (DW12BTED4)		82068	
2.2 HDi 165	120	02/08 →	2.179	D	M	4	16	4HP (DW12BTED4)		82068	
2.2 HDi 200	150	07/10 →	2.179	D	M	4	16	4HL (DW12C)		82068	
2.7 HDi	150	02/08 →	2.720	D	M	6	24	DT17ED4		82067	
	150	02/08 →	2.720	D	M	6	24	DT17ED4, UHZ (DT17BTED4)		82067	
3.0 HDi 240	177	04/09 →	2.992	D	M	6	24	DT20C		84019	<b>NEW</b>
3.0 V6	155	02/08 →	2.946	B	M	6	24	XFU (ES9A)		81813	

### C 6

2.2 HDi	120	06/06 →	2.179	D	M	4	16	4HP (DW12BTED4)		82068	
	125	06/06 →	2.179	D	M	4	16	4HT (DW12BTED4)		82068	
2.7 HDi	150	09/05 →	2.720	D	M	6	24	DT17ED4, UHZ (DT17BTED4)		82067	
3.0 HDi	177	04/09 →	2.992	D	M	6	24	DT20C		84019	<b>NEW</b>
3.0 V6	155	09/05 →	2.946	B	M	6	24	XFV (ES9A), XFX (ES9J4S)		81813	

### C 8

2.0	100	07/02 →	1.997	B	M	4	16	RFN (EW10J4)	(-)COP	84038	<b>NEW</b>
	100	07/02 →	1.997	B	M	4	16	RFN (EW10J4)	(+)COP	82089	
	100	07/02 →	1.997	B	M	4	16	RFN (EW10J4)		82089	
	100	07/02 →	1.997	B	M	4	16	RFN (EW10J4)		81799	

**KW**

**cm<sup>3</sup>**

**NO. OF VALVES**

**MAGNETI MARELLI**
**CITROËN**
**C 8**

2.0 16V	103	09/05 →	1.997	B	M	4	16	RFJ (EW10A)	(-)COP	84038	<b>NEW</b>
	103	09/05 →	1.997	B	M	4	16	RFJ (EW10A)	(+)COP	82089	
	103	09/05 →	1.997	B	M	4	16	RFJ (EW10A)		82089	
	103	09/05 →	1.997	B	M	4	16	RFJ (EW10A)		81799	
	104	09/05 →	1.997	B	M	4	16	RFJ (EW10A)	(-)COP	84038	<b>NEW</b>
	104	09/05 →	1.997	B	M	4	16	RFJ (EW10A)	(+)COP	82089	
	104	09/05 →	1.997	B	M	4	16	RFJ (EW10A)		82089	
	104	09/05 →	1.997	B	M	4	16	RFJ (EW10A)		81799	
2.0 HDi	79	07/02 →	1.997	D	M	4	16	RHM (DW10ATED4), RHT (DW10ATED4)		81713	
	80	07/02 →	1.997	D	M	4	16	RHW (DW10ATED4)		81800	
	88	02/07 →	1.997	D	M	4	16	RHK (DW10UTED4)		81800	
2.0 HDi 135	100	03/06 →	1.997	D	M	4	16	RHD (DW10CB), RHD (DW10CTED4), RHR (DW10BTED4)		81800	
2.0 HDi 165	120	03/06 →	1.997	D	M	4	16	RHE (DW10CTED4), RHH (DW10CTED4)		81800	
2.2	116	07/02 →	2.230	B	M	4	16	3FZ (EW12J4)	(-)COP	84038	<b>NEW</b>
	116	07/02 →	2.230	B	M	4	16	3FZ (EW12J4)	(+)COP	82089	
	116	07/02 →	2.230	B	M	4	16	3FZ (EW12J4)		82089	
	116	07/02 →	2.230	B	M	4	16	3FZ (EW12J4)		81799	
2.2 HDi	94	07/02 →	2.179	D	M	4	16	4HW (DW12TED4)		81800	
	120	06/07 →	2.179	D	M	4	16	4HP (DW12BTED4), 4HR (DW12BTED4)		82068	
	125	06/06 →	2.179	D	M	4	16	4HT (DW12BTED4)		82068	
3.0 V6	150	07/02 →	2.946	B	M	6	24	XFX (ES9J4S)		81813	

**C-Crosser**

2.2 HDi	115	02/07 →	2.179	D	M	4	16	4HN (DW12MTED4)		82068	
---------	-----	---------	-------	---	---	---	----	-----------------	--	-------	--

**C-Elysee**

1.2 VTi 72	53	11/12 →	1.199	B	M	3	12	HMY (EB2M)		84066	<b>NEW</b>
1.2 VTi 82	60	12/14 →	1.199	B	M	3	12			84066	<b>NEW</b>
1.6 BlueHDi 100	73	11/14 →	1.560	D	M	4	8	BHY (DV6FD)		81869	
1.6 HDi 92	68	11/12 →	1.560	D	M	4	8	9HJ (DV6DTEDM), 9HP (DV6DTEDE)		81869	
1.6 VTi 115	85	11/12 →	1.587	B	M	4	16	NFP (EC5)		81753	

**CX II, Break**

25 D	54	08/85 → 12/92	2.500	D	M	4	8	M25-660		81822	
25 D Turbo	88	01/87 → 12/92	2.500	D	M	4	8	M25-669		81822	
25 D Turbo 2	88	01/87 → 12/92	2.500	D	M	4	8	M25-669		81822	
25 GTi	89	05/86 → 12/92	2.500	B	M	4	8	M25-668	(-)AC	81822	
25 GTi Turbo 2	115	09/86 → 12/92	2.500	B	M	4	8	M25-667	(-)AC	81822	
	122	08/85 → 12/92	2.500	B	M	4	8	M25-662	(-)AC	81822	
25 i	89	05/86 → 12/92	2.500	B	M	4	8	M25-668	(-)AC	81822	
25 TRi	100	08/85 → 12/92	2.500	B	M	4	8	M25-659	(-)AC	81822	

--	--	--	--	--	--	--	--	--	--

## CITROËN

### DS 3, Cabrio

1.2 THP 110	81	10/14 → 03/15	1.199	B	M	3	12	HNZ (EB2DT)	84066	
1.2 VTi 82	60	01/13 → 03/15	1.199	B	M	3	12	HMZ (EB2F)	84066	
1.4 HDi 70	50	04/10 → 07/15	1.398	D	M	4	8	8HR (DV4C)	81798	
1.4 VTi 95	70	04/10 → 07/15	1.397	B	M	4	16	8FP (EP3)	82032	
1.4 VTi 95 LPG	70	08/12 → 07/15	1.397		M	4	16	8FN (EP3)	82032	
1.4 VTi 98	72	11/09 → 07/15	1.397	B	M	4	16	8FR (EP3)	82032	
1.6 BlueHDi 100	73	07/14 → 07/15	1.560	D	M	4	8	BHY (DV6FD)	81869	
1.6 BlueHDi 120	88	10/13 → 07/15	1.560	D	M	4	8	BHZ (DV6FC)	81869	
1.6 HDi 110	82	11/09 → 07/15	1.560	D	M	4	8	9HR (DV6C)	81869	
1.6 HDi 115	84	08/12 → 07/15	1.560	D	M	4	8	9HD (DV6C), 9HL (DV6C)	81869	
1.6 HDi 115	85	10/13 → 07/15	1.560	D	M	4	8	BHX (DV6FC)	81869	
1.6 HDi 90	68	11/09 → 07/15	1.560	D	M	4	8	9HP (DV6DTEd)	81869	
	69	01/13 → 07/15	1.560	D	M	4	8	9HP (DV6DTEd)	81869	
1.6 Racing	147	02/11 → 07/15	1.598	B	M	4	16	5FU (EP6CDTX)	82032	
	152	02/11 → 07/15	1.598	B	M	4	16	5FD (EP6DTS)	82032	
1.6 THP 150	110	01/13 → 07/15	1.598	B	M	4	16	5FN (EP6CDT)	82032	
	110	01/10 → 07/15	1.598	B	M	4	16	5FN (EP6CDT), 5FX (EP6DT)	82032	
1.6 THP 155	115	04/10 → 07/15	1.598	B	M	4	16	5FR (EP6DT), 5FV (EP6CDT)	82032	
	115	01/13 → 07/15	1.598	B	M	4	16	5FV (EP6CDT)	82032	
1.6 VTi 120	88	04/10 → 07/15	1.598	B	M	4	16	5FS (EP6C)	82032	

### DS 4

1.2 THP 130	96	07/14 → 07/15	1.199	B	M	3	12	HNY (EB2DTS)	84066	
1.6 HDi 110	81	04/11 → 07/15	1.560		M	4	16		81869	
	82	04/11 → 07/15	1.560	D	M	4	8	9HR (DV6C)	81869	
1.6 HDi 115	84	08/12 → 07/15	1.560	D	M	4	8	9HD (DV6C), 9HL (DV6C)	81869	
1.6 HDi 90	68	05/11 → 07/15	1.560	D	M	4	8	9HP (DV6DTEd)	81869	
1.6 THP 155	115	04/11 → 07/15	1.598	B	M	4	16	5FV (EP6CDT)	82032	
1.6 THP 160	120	04/12 → 07/15	1.598	B	M	4	16	5FM (EP6DT)	82032	
1.6 THP 165	121	01/12 → 07/15	1.598	B	M	4	16	5FM (EP6DT), 5GZ (EP6FDT)	82032	
1.6 THP 200	147	04/11 → 07/15	1.598	B	M	4	16	5FU (EP6DTX)	82032	
1.6 VTi 120	88	04/11 → 07/15	1.598	B	M	4	16	5FS (EP6C)	82032	
2.0 HDi 135	100	09/11 → 07/15	1.997	D	M	4	16	RHE (DW10CTED4)	84020	
2.0 HDi 165	120	04/11 → 07/15	1.997	D	M	4	16	RHH (DW10CTED4)	84020	

### DS 5

1.6 BlueHDi 120	88	07/14 → 07/15	1.560	D	M	4	8	BHZ (DV6FC)	81869	
1.6 HDi	85	11/13 → 07/15	1.560	D	M	4	8	BHX (DV6FC)	81869	
1.6 HDi 110	82	11/11 → 07/15	1.560	D	M	4	8	9HR (DV6C)	81869	
1.6 HDi 115	84	06/12 → 07/15	1.560	D	M	4	8	9HD (DV6C)	81869	
1.6 THP 155	115	11/11 → 07/15	1.598	B	M	4	16	5FV (EP6CDT)	82032	
1.6 THP 200	147	11/11 → 07/15	1.598	B	M	4	16	5FU (EP6DTX)	82032	
2.0 BlueHDi 180	133	08/13 → 07/15	1.997	D	M	4	16	AHW (DW10FC)	82068	

**KW**

**cm<sup>3</sup>**

**NO. OF VALVES**

**CITROËN**
**DS 5**

2.0 HDi 135	100	11/11 → 07/15	1.997	D	M	4	16	RHD (DW10CB)		84020	<b>NEW</b>
2.0 HDi 165	120	11/11 → 07/15	1.997	D	M	4	16	RHH (DW10CTED4)		84020	<b>NEW</b>
2.0 HDi 165 Hybrid4 4x4	120	12/11 → 07/15	1.997		M	4	16	RHC (DW10CTED4)		84020	<b>NEW</b>

**Evasion**

1.8	73	05/97 → 07/02	1.761	B	M	4	8	LFZ (XU7JP)	06-1996 →	81512	
1.9 TD	66	11/94 → 07/02	1.905	D	M	4	8	D8B (XUD9TF), DHX (XUD9TF/BTF)		81642	
	68	10/95 → 12/98	1.905	D	M	4	8	D8B (XUD9TF)		81642	
2.0	89	06/94 → 07/02	1.998	B	M	4	8	RFU (XU10J2/C)	06-1994 →	81642	
2.0 16V	100	05/00 → 07/02	1.997	B	M	4	16	RFN (EW10J4)	(-)COP	84038	<b>NEW</b>
	100	05/00 → 07/02	1.997	B	M	4	16	RFN (EW10J4)	(+)COP	82089	
	100	05/00 → 07/02	1.997	B	M	4	16	RFN (EW10J4)		82089	
	100	05/00 → 07/02	1.997	B	M	4	16	RFN (EW10J4)		81799	
	97	05/98 → 04/00	1.998	B	M	4	16	RFV (XU10J4R)		81711	
2.0 HDi	80	08/99 → 07/02	1.997	D	M	4	8	RHZ (DW10ATED)		81713	
2.0 HDi 16V	80	09/99 → 07/02	1.997	D	M	4	16	RHW (DW10ATED4)		81713	
2.0 Turbo C.T.	108	06/94 → 07/02	1.998	B	M	4	8	RGX (XU10J2TE)	06-1994 →	81642	
2.1 TD	80	05/96 → 07/02	2.088	D	M	4	12	P8C (XUD11BTE)	06-1996 →	81353	

**Jumper I**

1.9 D	50	07/99 → 04/02	1.905	D	M	4	8	DJY (XUD9A)		81642	
	51	01/99 → 04/02	1.905	D	M	4	8	D9B (XUD9A/U)		81642	
1.9 TD	66	08/94 → 04/02	1.905	D	M	4	8	D8C (XUD9UTF)		81642	
	66	03/94 → 04/02	1.905	D	M	4	8	DHX (XUD9TF/BTF)		81642	
	68	02/94 → 04/02	1.905	D	M	4	8	D8C (XUD9UTF)		81642	
1.9 TD 4x4	68	08/96 → 04/02	1.905	D	M	4	8	D8C (XUD9UTF)		81642	
2.0	80	02/94 → 04/02	1.998	B	M	4	8	RFW (XU10J2U)		81642	
2.0 4x4	80	08/96 → 04/02	1.998	B	M	4	8	RFW (XU10J2U)		81642	
2.0 HDi	62	11/01 → 04/02	1.997	D	M	4	8	RHV (DW10UTD)		81713	
2.5 D	63	08/94 → 04/02	2.446	D	M	4	8	T9A (DJ5)	→ 04-1996	81752	
	63	08/94 → 04/02	2.446	D	M	4	8	T9A (DJ5)	05-1996 →	81712	
2.5 D 4x4	63	08/96 → 04/02	2.446	D	M	4	8	T9A (DJ5)		81712	
2.5 DT 4x4	76	10/96 → 08/97	2.446	D	M	4	12	THZ (DJ5T)		81712	
2.5 TD	76	08/94 → 04/02	2.446	D	M	4	12	T8A (DJ5T)	→ 04-1996	81752	
	76	08/94 → 04/02	2.446	D	M	4	12	T8A (DJ5T)	05-1996 →	81712	
2.5 TD 4x4	76	08/96 → 04/02	2.446	D	M	4	12	T8A (DJ5T)		81712	
2.5 TDi	79	12/96 → 11/00	2.446	D	M	4	8	THX (DJ5TED)		81712	
2.5 TDi 4x4	79	12/96 → 11/00	2.446	D	M	4	8	THX (DJ5TED)		81712	
2.8 D	64	01/99 → 02/02	2.798	D	M	4	8	8140.63 (F28D)		81316	
2.8 HDi	93	10/00 → 01/02	2.798	D	M	4	8	8140.43S		81316	
	94	09/00 → 04/02	2.798	D	M	4	8	8140.43S		81316	
2.8 HDi 4x4	94	09/00 → 04/02	2.798	D	M	4	8	8140.43S		81316	



--	--	--	--	--	--	--	--	--	--

## CITROËN

### Jumper II

2.0	81	04/02 →	1.998	B	M	4	8	XU10J2		81642
2.0 bivalent	81	02/03 →	1.998		M	4	8	XU10J2		81642
2.0 HDi	62	04/02 →	1.997	D	M	4	8	RHV (DW10TD), RHV (DW10UTD)		81713
	62	04/02 →	1.997	D	M	4	8	RHV (DW10UTD)		81713
2.2 HDi	74	04/02 →	2.179	D	M	4	8	4HY (DW12UTED)		81800
2.8 HDi	94	04/02 →	2.798	D	AM	4	8	8140.43S		81316
	107	05/04 →	2.798	D	M	4	8	8140.43N		81316
	107	05/04 →	2.800	D	M	4	8	8140.43N		81316
2.8 HDi 4x4	94	04/02 →	2.798	D	M	4	8	8140.43S		81316
	94	02/02 → 06/06	2.798	D	M	4	8	F28TDCR		81316
2.8 HDi Trazione integrale	94	04/02 →	2.798	D	AM	4	8	8140.43S		81316

### Jumper III

2.2 HDi 100	74	04/06 →	2.198	D	M	4	16	4HV (P22DTE)		82066
2.2 HDi 120	88	04/06 →	2.198	D	M	4	16	4HU (P22DTE)		82066
2.2 HDi 150	110	07/11 →	2.198	D	M	4	16	4HJ (P22DTE)		82066
3.0 HDi 145	107	07/10 →	2.999	D	M	4	16	F1CE3481N		82094
3.0 HDi 155	115	07/10 →	2.999	D	M	4	16	F1CE0481D (F30DT)		82094
3.0 HDi 160	116	09/06 →	2.999	D	M	4	16	F1CE0481D (F30DT)		82094
3.0 HDi 180	130	07/11 →	2.999	D	M	4	16	F1CE0481D (F30DT)		82094

### Jumpy I

1.6	58	10/95 →	1.581	B	M	4	8	1580SPI, 220A2.000	(-)COP	81368
	58	10/95 →	1.581	B	M	4	8	1580SPI, 220A2.000	(+)COP	81346
	59	10/95 → 08/00	1.581	B	M	4	8	220A2.000	(-)COP	81368
	59	10/95 → 08/00	1.581	B	M	4	8	220A2.000	(+)COP	81346
1.6 i	58	10/95 →	1.581	B	M	4	8	1580SPI, 220A2.000	(-)COP	81368
	58	10/95 →	1.581	B	M	4	8	1580SPI, 220A2.000	(+)COP, 10-1995 →	81346
1.9 D	51	10/95 → 04/98	1.905	D	M	4	8	D9B (XUD9A/U)	10-1995 →	81642
	51	10/95 → 08/98	1.905	D	M	4	8	D9B (XUD9A/U)		81642
1.9 D 70	51	04/98 →	1.868	D	M	4	8	WJY (DW8B), WJZ (DW8)		81713
1.9 DT	65	10/95 → 08/00	1.905	D	M	4	8			81642
1.9 TD	66	10/95 →	1.905	D	M	4	8	DHX (XUD9TF/BTF)	10-1995 →	81642
	66	10/95 →	1.905	D	M	4	8	DHX (XUD9TF/BTF)		81642
	68	04/96 →	1.905	D	M	4	8	D8B (XUD9TF)		81642
2.0	100	04/00 → 12/06	1.997	B	M	4	16	RFN (EW10J4)	(-)COP	84038
	100	04/00 → 12/06	1.997	B	M	4	16	RFN (EW10J4)	(+)COP	82089
	100	04/00 → 12/06	1.997	B	M	4	16	RFN (EW10J4)		82089
	100	04/00 → 12/06	1.997	B	M	4	16	RFN (EW10J4)		81799
2.0 HDi 110	80	03/00 →	1.997	D	M	4	16	RHW (DW10ATED4)		81713
	80	03/00 →	1.997	D	M	4	8	RHZ (DW10ATED)		81713
2.0 HDi 95	69	10/99 →	1.997	D	M	4	8	RHX (DW10BTED)		81713

**KW**

**cm<sup>3</sup>**

**NO. OF VALVES**

**CITROËN**
**Jumpy I**

2.0 i 16V	102	03/00 →	1.997	B	M	4	16	RFN (EW10J4)	(-)COP	84038	<b>NEW</b>
	102	03/00 →	1.997	B	M	4	16	RFN (EW10J4)	(+)COP	82089	
	102	03/00 →	1.997	B	M	4	16	RFN (EW10J4)		82089	
	102	03/00 →	1.997	B	M	4	16	RFN (EW10J4)		81799	

**Jumpy II**

1.9 TD	68	10/99 →	1.905	D	M	4	8	D8B (XUD9TF)		81642	
2.0	100	12/03 → 10/06	1.997	B	M	4	16	RFN (EW10J4)	(-)COP	84038	<b>NEW</b>
	100	12/03 → 10/06	1.997	B	M	4	16	RFN (EW10J4)	(+)COP	82089	
	100	12/03 → 10/06	1.997	B	M	4	16	RFN (EW10J4)		82089	
	100	12/03 → 10/06	1.997	B	M	4	16	RFN (EW10J4)		81799	
2.0 HDi 110	80	12/03 → 10/06	1.997	D	M	4	8	RHZ (DW10ATED)		81713	
2.0 HDi 110 16V	80	12/03 → 10/06	1.997	D	M	4	16	RHW (DW10ATED4)		81713	
2.0 HDi 95	69	10/99 →	1.997	D	M	4	8	RHX (DW10BTED)		81713	

**Jumpy III**

1.6 HDi 90 16V	66	01/07 →	1.560	D	M	4	16	9HU (DV6UTED4)		81869	
1.6 HDi 90 8V	66	01/07 →	1.560	D	M	4	8	9HH (DV6DUM), 9HM (DV6UC)		81869	
2.0 HDi 120	88	01/07 →	1.997	D	M	4	16	RHK (DW10UTED4)		81800	
2.0 HDi 125	94	07/11 →	1.997	D	M	4	16	AHZ (DW10CD)		84020	<b>NEW</b>
2.0 HDi 140	100	01/07 →	1.997	D	M	4	16	RHR (DW10BTED4)		81800	
2.0 HDi 165	120	07/10 →	1.997	D	M	4	16	RHH (DW10CTED4)		84020	<b>NEW</b>
2.0 HDi 95	72	07/11 →	1.997	D	M	4	16	AHY (DW10CE)		84020	<b>NEW</b>
2.0 i	103	01/07 →	1.997	B	M	4	16	RFH (EW10A)	(-)COP	84038	<b>NEW</b>
	103	01/07 →	1.997	B	M	4	16	RFH (EW10A)	(+)COP	82089	
	103	01/07 →	1.997	B	M	4	16	RFH (EW10A)		82089	
	103	01/07 →	1.997	B	M	4	16	RFH (EW10A)		81799	

**Nemo, Van**

1.3 HDi 75	55	10/10 →	1.248	D	M	4	16	FHZ (F13DTE5)		81862	
1.4	54	04/09 →	1.360	B	M	4	8	KFT (TU3A), KFV (TU3A)		81797	
	54	02/08 →	1.360	B	M	4	8	KFV (TU3A)		81797	
1.4 HDi	50	02/08 →	1.398	D	M	4	8	8HS (DV4TED)		81798	
	50	04/09 →	1.399	D	M	4	8	8HS (DV4TED)		81798	

**Saxo**

1.0 X	33	05/96 → 11/98	954	B	M	4	8	CDZ (TU9M)		81556	
	37	05/98 → 06/03	954	B	M	4	8	CDZ (TU9M)		81556	
1.1 X, SX	40	05/96 → 09/03	1.124	B	M	4	8	HDZ (TU1M)	→ 07-2000, → M: 3.666.765	81556	
	40	05/96 → 09/03	1.124	B	M	4	8	HDZ (TU1M)	08-2000 →, M →: 3.666.766	81797	
	44	05/96 → 09/03	1.124	B	M	4	8	HDZ (TU1M), HFX (TU1JP)	→ 07-2000, → M: 3.666.765	81556	
	44	05/96 → 09/03	1.124	B	M	4	8	HDZ (TU1M), HFX (TU1JP)	08-2000 →, M →: 3.666.766	81797	

**KW**

**cm<sup>3</sup>**

**NO. OF VALVES**

**MAGNETI MARELLI**
**CITROËN**
**Saxo**

1.4 VTS	55	05/96 → 06/03	1.360	B	M	4	8	KFW (TU3JP), KFX (TU3JP)	→ 07-2000, → M: 3.666.765	81556
	55	05/96 → 06/03	1.360	B	M	4	8	KFW (TU3JP), KFX (TU3JP)	08-2000 →, M →: 3.666.766	81797
1.5 D	40	09/96 → 09/03	1.527	D	M	4	8	VJY (TUD5)		81513
	42	09/96 → 06/01	1.527	D	M	4	8	VJZ (TUD5)		81513
	43	07/01 → 04/04	1.527	D	M	4	8			81753
1.6	66	02/96 → 06/03	1.587	B	M	4	8	NFZ (TU5JP)		81513
	74	02/01 → 04/04	1.587	B	M	4	8	NFT (TU5JP)		81513
	88	02/96 → 04/04	1.587	B	M	4	16	NFX (TU5JP4)		81753
1.6 VTL,VTR	65	05/96 → 06/03	1.587	B	M	4	8	NFZ (TU5JP)		81513
1.6 VTS	72	09/00 → 09/03	1.587	B	M	4	8	NFT (TU5JP)		81513
	87	06/96 → 09/03	1.587	B	M	4	16	NFX (TU5JP4)		81753

**Visa, Cabrio**

11 E	37	07/82 → 03/91	1.124	B	M	4	8	109/5F		81572
14	44	07/84 → 03/91	1.360	B	M	4	8	150D (XY7)		81572
14 GT	58	03/82 → 03/91	1.360	B	M	4	8	150B (XY8)		81572
16 GTI	83	06/86 → 03/91	1.580	B	M	4	8	B6D	PROD →: 3584	81512
17 D	44	04/84 → 03/91	1.769	D	M	4	8	161A (XUD7)	→ 12-1986, → PROD: 3583	81554
	44	04/84 → 03/91	1.769	D	M	4	8	161A (XUD7)	01-1987 →, PROD →: 3584	81512

**Xantia I, Break**

1.6 i	65	03/93 → 01/98	1.580	B	M	4	8	BFZ (XU5JP)	11-1996 →	81512
	66	04/97 → 01/98	1.761	B	M	4	8	LFX (XU7JB)		81512
1.8 i	74	03/93 → 01/98	1.761	B	M	4	8	LFZ (XU7JP)	03-1993 →, → 10-1996	81512
	74	06/95 → 01/98	1.761	B	M	4	8	LFZ (XU7JP)	11-1996 →	81512
1.8 i 16V	81	06/95 → 01/98	1.761	B	M	4	16	LFY (XU7JP4)	11-1996 →	81710
1.9 D	50	06/94 → 01/98	1.905	D	M	4	8	DJZ (XUD9Y)	→ PROD: 6264	81672
	50	06/94 → 01/98	1.905	D	M	4	8	DJZ (XUD9Y)	PROD →: 6265	81642
	51	06/94 → 01/98	1.905	D	M	4	8	D9B (XUD9A/L)	→ PROD: 6264	81672
	51	06/94 → 01/98	1.905	D	M	4	8	D9B (XUD9A/L)	PROD →: 6265	81642
1.9 SD	55	02/96 → 01/98	1.905	D	M	4	8	DHW (XUD9SD)	→ PROD: 6264	81672
	55	02/96 → 01/98	1.905	D	M	4	8	DHW (XUD9SD)	PROD →: 6265	81642
1.9 Turbo D	66	06/95 → 01/98	1.905	D	M	4	8	D8B (XUD9TF), DHX (XUD9TF/BTF), DHY (XUD9TE/Y)	→ PROD: 6264	81672
	66	06/95 → 01/98	1.905	D	M	4	8	D8B (XUD9TF), DHX (XUD9TF/BTF), DHY (XUD9TE/Y)	PROD →: 6265	81642
	66	10/94 → 01/98	1.905	D	M	4	8	DHX (XUD9TF/BTF), DHY (XUD9TE/Y)	→ PROD: 6264	81672
	66	10/94 → 01/98	1.905	D	M	4	8	DHX (XUD9TF/BTF), DHY (XUD9TE/Y)	PROD →: 6265	81642

**KW**

**cm<sup>3</sup>**

**NO. OF VALVES**

**CITROËN**
**Xantia I, Break**

2.0 i	89	03/93 → 01/98	1.998	B	M	4	8	RFX (XU10J2C)	03-1993 →, → 05-1995	81642
	89	06/95 → 01/98	1.998	B	M	4	8	RFX (XU10J2C)		81642
2.0 i 16V	97	06/95 → 01/98	1.998	B	M	4	16	RFV (XU10J4R)	→ 10-1996	81642
	97	06/95 → 01/98	1.998	B	M	4	16	RFV (XU10J4R)	11-1996 →	81711
	110	06/94 → 01/98	1.998	B	M	4	16	RFT (XU10J4/Z)	06-1995 →, → 10-1996	81642
2.0 Turbo	108	06/95 → 01/98	1.998	B	M	4	8	RGX (XU10J2TE)	06-1995 →	81642
2.1 Turbo D 12V	80	06/95 → 01/98	2.088	D	M	4	12	P8C (XUD11BTE)	06-1995 →	81353
	80	06/96 → 01/98	2.088	D	M	4	12	P8C (XUD11BTE)	11-1996 →	81353
3.0 i 24V	140	01/97 → 01/98	2.946	B	M	6	24	XFZ (ES9J4)	→ T: 08441	81844
	140	01/97 → 01/98	2.946	B	M	6	24	XFZ (ES9J4)	T →: 08442	82042

**Xantia II, Break**

1.6 i SX	65	01/98 → 03/01	1.580	B	M	4	8	BFZ (XU5JP)		81512
1.8 i	66	01/98 → 04/03	1.761	B	M	4	8	LFX (XU7JB)		81512
1.8 i 16V	81	01/98 → 04/03	1.761	B	M	4	16	LFY (XU7JP4)		81710
1.9 SD	55	01/98 → 04/03	1.905	D	M	4	8	DHW (XUD9SD)		81642
1.9 Turbo D	66	01/98 → 04/03	1.905	D	M	4	8	D8B (XUD9TF), DHX (XUD9TF/BTF)		81642
	66	01/98 → 04/03	1.905	D	M	4	8	DHX (XUD9TF/BTF), DHY (XUD9TE/Y)		81642
2.0 HDI 109	80	02/99 → 04/03	1.997	D	M	4	8	RHZ (DW10ATED)		81713
2.0 HDI 90	66	03/99 → 04/03	1.997	D	M	4	8	RHY (DW10TD)		81713
2.0 i	89	01/98 → 04/03	1.998	B	M	4	8	RFX (XU10J2C)		81642
2.0 i 16V	97	01/98 → 04/03	1.998	B	M	4	16	RFV (XU10J4R)		81711
2.0 Turbo	108	01/98 → 04/03	1.998	B	M	4	8	RGX (XU10J2TE)		81642
2.1 Turbo D 12V	80	01/98 → 02/99	2.088	D	M	4	12	P8C (XUD11BTE)	11-1996 →	81353
3.0 V6	140	01/98 → 04/03	2.946	B	M	6	24	XFZ (ES9J4)	→ T: 08441	81844
	140	01/98 → 04/03	2.946	B	M	6	24	XFZ (ES9J4)	T →: 08442	82042

**XM I, Break**

2.0	84	05/89 → 04/94	1.998	B	M	4	8			81642
2.0 i	79	05/89 → 04/94	1.998	B	M	4	8	RDZ (XU10MZ)		81642
	89	05/89 → 06/94	1.998	B	M	4	8	RFZ (XU10J2)		81642
2.0 i Turbo	104	09/92 → 06/94	1.998	B	M	4	8	RGY (XU10J2TE/Z)	01-1109310 →, → 05-1994	81642
2.0 Turbo	104	09/92 → 04/94	1.998	B	M	4	8	RGY (XU10J2TE/Z)		81642
2.1 D 12V	60	05/89 → 06/94	2.138	D	M	4	12	P9A (XUD11A)		81642
2.1 TD 12V	80	11/91 → 04/94	2.088	D	M	4	12	P8A (XUD11ATE), P8C (XUD11BTE), PHZ (XUD11ATE), PJZ (XUD11ATE)	01-1991 →, → 07-1994	81353
	80	05/89 → 06/94	2.088	D	M	4	12	P8A (XUD11ATE), PHZ (XUD11ATE), PJZ (XUD11ATE)	05-1989 →, → 07-1994	81353

KW	cm³					NO. OF VALVES		

## CITROËN

### XM II, Break

2.0 i 16V	97	05/94 → 10/00	1.998	B	M	4	16	RFV (XU10J4R)	08-1994 →	81711
2.0 Turbo	108	05/94 → 10/00	1.998	B	M	4	8	RGX (XU10J2TE)		81642
	108	05/94 → 10/00	1.998	B	M	4	8	RGX (XU10J2TE), RGY (XU10J2TE/Z)		81642
2.1 D12	60	07/94 → 06/96	2.138	D	M	4	12	P9A (XUD11A)		81642
2.1 D12 VSX	60	03/96 → 08/96	2.138	D	M	4	12	P9A (XUD11A)		81642
2.1 TD 12V	80	05/94 → 10/00	2.088	D	M	4	12	P8A (XUD11ATE), P8C (XUD120BTE), PHZ (XUD11ATE), PJZ (XUD11ATE)	01-1994 →	81353
	80	05/94 → 10/00	2.088	D	M	4	12	P8C (XUD11BTE), PHZ (XUD11ATE), PJZ (XUD11ATE)	01-1993 →	81353
2.5 TD	95	05/94 → 10/00	2.446	D	M	4	12	THY (DK5ATE)	→ PROD: 7143	81752
	95	05/94 → 10/00	2.446	D	M	4	12	THY (DK5ATE)	PROD →: 7144	81712
3.0 V6	140	04/97 → 10/00	2.946	B	M	6	24	XFZ (ES9J4)	→ T: 08441	81844
	140	04/97 → 10/00	2.946	B	M	6	24	XFZ (ES9J4)	T →: 08442	82042

### Xsara, Break, Coupé, Picasso, Van

1.4 HDi	50	01/03 → 03/05	1.398	D	M	4	8	8HX (DV4TD)		81798
1.4 i	55	04/97 → 03/05	1.360	B	M	4	8	KFW (TU3JP), KFX (TU3JP)	→ 08-2000, → M: 3.666.765	81556
	55	04/97 → 03/05	1.360	B	M	4	8	KFW (TU3JP), KFX (TU3JP)	09-2000 →, M →: 3.666.766	81797
	55	10/97 → 08/05	1.360	B	M	4	8	KFW (TU3JP), KFX (TU3JP)	→ M: 3.666.765	81556
	55	10/97 → 08/05	1.360	B	M	4	8	KFW (TU3JP), KFX (TU3JP)	M →: 3.666.766	81797
1.5 D	42	04/97 → 09/00	1.527	D	M	4	8	VJZ (TUD5)		81513
	42	10/97 → 09/00	1.527	D	M	4	8	VJZ (TUD5)	→ PROD: 8385	81513
1.6	65	12/99 →	1.587	B	M	4	8	NFZ (TU5JP)		81513
	67	06/02 →	1.587	B	M	4	8	NFZ (TU5JP)		81513
	70	12/99 →	1.587	B	M	4	8	NFV (TU5JP)		81513
1.6 16V	80	09/05 →	1.587	B	M	4	16	NFU (TU5JP4)		81513
	80	09/00 → 03/05	1.587	B	AM	4	16	NFU (TU5JP4)		81753
	80	09/00 → 03/05	1.587	B	M	4	16	NFU (TU5JP4)		81753
	81	06/05 → 09/06	1.587	B	M	4	16	NFU (TU5JP4)		81753
1.6 Chrono	74	04/01 → 10/04	1.587	B	M	4	8			81513
1.6 HDi	66	09/05 →	1.560	D	M	4	16	9HX (DV6ATED4)		81869
	80	05/04 →	1.560	D	M	4	16	9HY (DV6TED4), 9HZ (DV6TED4)		81869
1.6 i	65	04/97 → 09/00	1.587	B	M	4	8	NFZ (TU5JP)	07-1997 →	81513
	65	02/98 → 09/00	1.587	B	M	4	8	NFZ (TU5JP)		81513

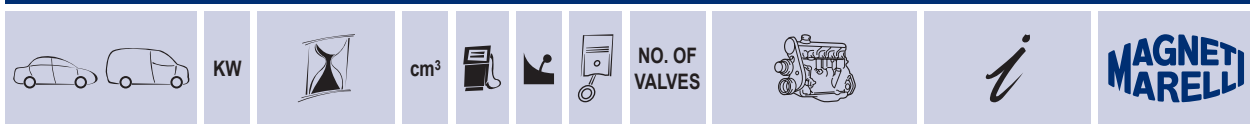

## CITROËN

### Xsara, Break, Coupé, Picasso, Van

1.8 16V	85	02/00 →	1.749	B	M	4	16	6FZ (EW7J4)	(-)COP	84038	<b>NEW</b>
	85	02/00 →	1.749	B	M	4	16	6FZ (EW7J4)	(+)COP	82089	
	85	02/00 →	1.749	B	M	4	16	6FZ (EW7J4)		82089	
	85	02/00 →	1.749	B	M	4	16	6FZ (EW7J4)		81799	
1.8 D	43	04/97 → 09/00	1.769	D	M	4	8	161A (XUD7), A9A (XUD7)		81642	
	43	10/97 → 09/00	1.769	D	M	4	8	A9A (XUD7)		81642	
1.8 i	66	04/97 → 09/00	1.761	B	M	4	8	LFX (XU7JB)		81512	
	66	10/97 → 09/00	1.761	B	M	4	8	LFX (XU7JB)	07-1997 →	81512	
	74	02/98 → 09/00	1.761	B	M	4	8	LFZ (XU7JP)		81512	
1.8 i 16V	81	04/97 → 09/00	1.761	B	M	4	16	LFY (XU7JP4)	07-1997 →	81710	
	81	10/97 → 09/00	1.761	B	M	4	16	LFY (XU7JP4)		81710	
1.8 i Aut.	74	04/97 → 09/00	1.761	B	A	4	8	LFZ (XU7JP)	07-1997 →	81512	
1.8 LPG	81	05/98 → 08/00	1.761		M	4	16	LFY (XU7JP4)		81710	
1.8 SX	76	06/00 → 08/05	1.761	B	M	4	8			81512	
1.8 TD	66	10/97 → 09/00	1.761	D	M	4	8			81642	
1.8 VTS	85	09/00 → 10/04	1.749	B	M	4	16	6FZ (EW7J4)	(-)COP	84038	<b>NEW</b>
	85	09/00 → 10/04	1.749	B	M	4	16	6FZ (EW7J4)	(+)COP	82089	
	85	09/00 → 10/04	1.749	B	M	4	16	6FZ (EW7J4)		82089	
	85	09/00 → 10/04	1.749	B	M	4	16	6FZ (EW7J4)		81799	
1.9 D	51	07/98 → 03/05	1.868	D	M	4	8	WJY (DW8B), WJZ (DW8)		81713	
	50	04/97 → 09/00	1.905	D	M	4	8	DJY (XUD9A)		81642	
	55	01/98 → 09/00	1.905	D	M	4	8	DHV (XUD9BSD)		81642	
1.9 SD	55	01/98 → 09/00	1.905	D	M	4	8	DHV (XUD9BSD)		81642	
1.9 TD	66	04/97 → 09/00	1.905	D	M	4	8	DHY (XUD9TE/Y)		81642	
2.0 16V	100	09/00 → 03/05	1.997	B	M	4	16	RFN (EW10J4)	(-)COP	84038	<b>NEW</b>
	100	09/00 → 03/05	1.997	B	M	4	16	RFN (EW10J4)	(+)COP	82089	
	100	09/00 → 03/05	1.997	B	M	4	16	RFN (EW10J4)		82089	
	100	09/00 → 03/05	1.997	B	M	4	16	RFN (EW10J4)		81799	
	97	07/98 → 09/00	1.998	B	M	4	16	RFV (XU10J4R)		81711	
	120	04/97 → 09/00	1.998	B	M	4	16	RFS (XU10J4RS)	01-1998 →	81711	
2.0 HDi	66	09/00 → 03/05	1.997	D	M	4	8	RHY (DW10TD)		81713	
2.0 HDi 109	80	05/01 → 03/05	1.997	D	AM	4	8	RHZ (DW10ATED)		81713	
2.0 HDi 90	66	02/99 → 03/05	1.997	D	M	4	8	RHY (DW10TD)		81713	
2.0 i 16V	120	02/98 → 03/05	1.998	B	M	4	16	RFS (XU10J4RS)		81711	
<b>ZX, Break</b>											
1,1	40	03/91 → 08/93	1.124	B	M	4	8	H1A, H1B		81556	
	44	03/91 → 06/97	1.124	B	M	4	8	HDZ (TU1M)		81556	
1.4	55	03/91 → 06/97	1.360	B	M	4	8	KDZ (TU3M/Z)		81556	
1.4 D	37	07/94 → 10/97	1.360	D	M	4	8	K9Y (TUD3Y)		81556	

**KW**

**cm<sup>3</sup>**

**NO. OF VALVES**

**CITROËN**
**ZX, Break**

1.4 i	55	10/93 → 10/97	1.360	B	M	4	8	KDX (TU3M/Z), KDY (TU3M), KFX (TU3JP)	07-1994 →, → 07-1995	81556
	55	03/91 → 06/97	1.360	B	M	4	8	KDX (TU3M/Z), KDZ (TU3M/Z), KFX (TU3JP)		81556
1.6 i	65	03/91 → 06/97	1.580	B	M	4	8	BDY (XU5M), BFZ (XU5JP)	→ 08-1992, → PROD: 5409	81554
	65	03/91 → 06/97	1.580	B	M	4	8	BDY (XU5M), BFZ (XU5JP)	09-1992 →, PROD →: 5410	81512
	65	10/93 → 10/97	1.580	B	M	4	8	BDY (XU5M), BFZ (XU5JP)	09-1992 →, PROD →: 5.410	81512
1.8 D	44	06/93 → 06/97	1.769	D	M	4	8	161A (XUD7)		81642
1.8 i	74	07/92 → 06/97	1.761	B	M	4	8	LFZ (XU7JP)	→ PROD: 5409	81554
	74	07/92 → 06/97	1.761	B	M	4	8	LFZ (XU7JP)	PROD →: 5410	81512
1.8 i 16V	81	01/96 → 06/97	1.761	B	M	4	16	LFY (XU7JP4)		81710
1.9 D	47	03/91 → 06/97	1.905	D	M	4	8	DJZ (XUD9Y)	→ 06-1994, → PROD: 6170	81672
	47	03/91 → 06/97	1.905	D	M	4	8	DJZ (XUD9Y)	07-1994 →, PROD →: 6171	81642
	50	06/94 → 10/97	1.905	D	M	4	8	D9B (XUD9A/U)	07-1994 →, PROD →: 6.171	81642
	50	07/93 → 06/97	1.905	D	M	4	8	D9B (XUD9A/U), DJY (XUD9A)	07-1994 →, PROD →: 6.171	81642
1.9 i	88	03/91 → 06/97	1.905	B	M	4	8	DKZ (XU9JA)	→ 08-1992, → PROD: 5409	81554
	88	03/91 → 06/97	1.905	B	M	4	8	DKZ (XU9JA)	09-1992 →, PROD →: 5410	81512
1.9 TD	66	07/92 → 06/97	1.905	D	M	4	8	DHY (XUD9TE/Y)	→ 06-1994, → PROD: 6170	81672
	66	07/92 → 06/97	1.905	D	M	4	8	DHY (XUD9TE/Y)	07-1994 →, PROD →: 6171	81642
2.0 i	89	07/92 → 06/97	1.998	B	M	4	8	RFX (XU10J2C)		81642
2.0 i 16V	110	06/94 → 06/97	1.998	B	M	4	16	RFT (XU10J4/Z)		81672
	112	07/92 → 10/94	1.998	B	M	4	16	RFT (XU10J4/Z), RFY (XU10J4/Z)		81672
	120	05/96 → 06/97	1.998	B	M	4	16	RFS (XU10J4RS)		81672

**DACIA**
**Dokker**

1.2 TCe	85	11/12 →	1.197	B	M	4	16	H5F402		84003
1.5 dCi	55	11/12 →	1.461	D	M	4	8	K9K612		82098
	66	11/12 →	1.461	D	M	4	8	K9K612		82098
1.6	61	11/12 →	1.598	B	M	4	8	K7M812, K7M828		84003

**KW**

**cm<sup>3</sup>**

**NO. OF VALVES**

**MAGNETI MARELLI**
**DACIA**
**Dokker Express**

1.2 TCe 115	84	12/12 →	1.198	B	M	4	16	H5F402		84003
1.5 dCi	55	12/12 →	1.461	D	M	4	8	K9K612		82098
	66	12/12 →	1.461	D	M	4	8	K9K612		82098
1.6	61	12/12 →	1.598	B	M	4	8	K7M812, K7M828		84003

**Duster**

1.2 TCe 125	92	10/13 →	1.197	B	M	4	16	H5F404		84003
1.2 TCe 125 4x4	92	06/15 →	1.197	B	M	4	16	H5F404		84003
1.5 dCi	63	04/10 →	1.461	D	M	4	8	K9K796, K9K830		84007
	66	10/10 →	1.461	D	M	4	8	K9K884, K9K892		82098
	79	06/10 →	1.461	D	M	4	8	K9K896		84007
	80	08/13 →	1.461	D	M	4	8	K9K856		82098
1.5 dCi 4x4	66	10/10 →	1.461	D	M	4	8	K9K884, K9K894		82098
	79	06/10 →	1.461	D	M	4	8	K9K898		84007
	80	08/13 →	1.461	D	M	4	8	K9K858		82098
1.6 16V	77	04/10 →	1.598	B	M	4	16	K4M690, K4M696		84039 <b>NEW</b>
	77	04/10 →	1.598	B	M	4	16	K4M690, K4M696		81806
1.6 16V 4x4	77	06/10 →	1.598	B	M	4	16	K4M606		84039 <b>NEW</b>
	77	06/10 →	1.598	B	M	4	16	K4M606		81806
1.6 16V Hi-Flex	77	08/10 →	1.598		M	4	16	K4M696		84039 <b>NEW</b>
	77	08/10 →	1.598		M	4	16	K4M696		81806
1.6 16V LPG	77	04/11 →	1.598		M	4	16	K4M696		84039 <b>NEW</b>
	77	04/11 →	1.598		M	4	16	K4M696		81806

**Lodgy**

1.2 TCe	85	03/12 →	1.197	B	M	4	16	H5F402		84003
1.5 dCi	66	03/12 →	1.461	D	M	4	8	K9K612		82098
	79	01/13 →	1.461	D	M	4	8	K9K846		82098
	80	06/15 →	1.461	D	M	4	8			82098
1.6	61	03/12 →	1.598	B	M	4	8	K7M812, K7M828		84003
1.6 LPG	61	11/13 →	1.598		M	4	8	K7M812, K7M828		84039 <b>NEW</b>

**Logan**

1.2	54	05/15 →	1.149	B	M	4	16			82090
	55	10/12 →	1.149	B	M	4	16	D4F732		82090
1.2 LPG	55	10/12 →	1.149		M	4	16	D4F734		82090
1.5 dCi	55	10/12 →	1.461	D	M	4	8	K9K612		81810
	55	10/12 →	1.461	D	M	4	8	K9K612		84007
	63	01/13 →	1.461	D	M	4	8	K9K830		81810
	63	01/13 →	1.461	D	M	4	8	K9K830		84007
	66	10/12 →	1.461	D	M	4	8	K9K612		82098
1.6 16V	77	01/13 →	1.598	B	M	4	16	K4M842		84039 <b>NEW</b>
	77	01/13 →	1.598	B	M	4	16	K4M842		81806
TCe 90	66	10/12 →	898	B	M	3	12	H4B400		84003





KW



cm<sup>3</sup>



NO. OF VALVES



MAGNETI MARELLI

**DACIA**

**Logan MCV**

1.2	54	05/15 →	1.149	B	M	4	16	D4F732		82090
	55	02/13 →	1.149	B	M	4	16	D4F732		82090
1.2 LPG	55	02/13 →	1.149		M	4	16	D4F734		82090
1.4	55	02/07 →	1.390	B	M	4	8	K7J710		81579
1.5 dCi	55	02/13 →	1.461	D	M	4	8	K9K612		81810
	55	02/13 →	1.461	D	M	4	8	K9K612		84007
	63	02/13 →	1.461	D	M	4	8	K9K830		81810
	63	02/13 →	1.461	D	M	4	8	K9K830		84007
	66	02/13 →	1.461	D	M	4	8	K9K612		81810
	66	02/13 →	1.461	D	M	4	8	K9K612		84007
	50	02/07 →	1.461	D	M	4	8	K9K792		84007
	55	05/10 →	1.461	D	M	4	8	K9K892		82098
	63	09/07 →	1.461	D	M	4	8	K9K796		84007
1.6	65	05/10 →	1.461	D	M	4	8	K9K892		82098
	64	02/07 →	1.598	B	M	4	8	K7M710		81579
1.6 16V	77	02/07 →	1.598	B	M	4	16	K4M690, K4M696		84039 <b>NEW</b>
	77	02/07 →	1.598	B	M	4	16	K4M690, K4M696		81806
1.6 16V Hi-Flex	77	11/09 →	1.598		M	4	16	K4M690, K4M694		84039 <b>NEW</b>
	77	11/09 →	1.598		M	4	16	K4M690, K4M694		81806
1.6 Bifuel	64	11/08 →	1.598	BF	M	4	8	K7M710		81579
1.6 MPI 85	62	05/10 →	1.598	B	M	4	8	K7M800		84039 <b>NEW</b>
TCe 90	66	02/13 →	898	B	M	3	12	H4B400		84003

**Logan, Station Wagon, Van**

1.2 16V	55	02/06 →	1.149	B	M	4	16	D4F732		82090
1.2 16V LPG	55	02/06 →	1.149		M	4	16	D4F734		82090
1.4	55	03/09 →	1.390	B	M	4	8	K7J710		81579
	55	09/04 →	1.390	B	M	4	8	K7J710		81579
1.4 MPI LPG	55	02/06 →	1.390		M	4	8	K7J710, K7J714		81579
1.5 dCi	55	05/10 →	1.461	D	M	4	8	K9K892		82098
	65	05/10 →	1.461	D	M	4	8	K9K892		82098
	48	09/05 →	1.461	D	M	4	8	K9K790		84007
	50	01/06 →	1.461	D	M	4	8	K9K792		84007
	55	05/10 →	1.461	D	M	4	8	K9K892		82098
	63	09/07 →	1.461	D	M	4	8	K9K796		84007
	65	05/10 →	1.461	D	M	4	8	K9K892		82098
1.6	64	03/09 →	1.598	B	M	4	8	K7M710		81579
	64	09/04 →	1.598	B	M	4	8	K7M710		81579
1.6 16V	77	02/06 →	1.598	B	M	4	16	K4M690, K4M696		84039 <b>NEW</b>
	77	02/06 →	1.598	B	M	4	16	K4M690, K4M696		81806
1.6 16V Flexifuel	77	07/10 →	1.598		M	4	16	K4M696		84039 <b>NEW</b>
	77	07/10 →	1.598		M	4	16	K4M696		81806
1.6 Bifuel	62	05/10 →	1.598	BF	M	4	8	K7M718		81579
	62	05/10 →	1.598	BF	M	4	8	K7M800		84039 <b>NEW</b>
1.6 MPI 85	62	05/10 →	1.598	B	M	4	8	K7M800		84039 <b>NEW</b>



KW



cm<sup>3</sup>



NO. OF VALVES



MAGNETI MARELLI

## DACIA

### Sandero I

1.2 16V	55	11/08 →	1.149	B	M	4	16	D4F732		81820
1.2 16V LPG	55	11/08 →	1.149		M	4	16	D4F732		82090
1.4	55	06/08 →	1.390	B	M	4	8	K7J710		81579
1.4 MPI LPG	53	01/09 →	1.390		M	4	8	K7J714		81579
1.5 dCi	50	11/08 →	1.461	D	M	4	8	K9K792		84007
	55	05/10 →	1.461	D	M	4	8	K9K892		82098
	63	11/08 →	1.461	D	M	4	8	K9K796		84007
	65	05/10 →	1.461	D	M	4	8	K9K892		82098
1.6	64	06/08 →	1.598	B	M	4	8	K7M710		81579
1.6 16V	77	07/11 →	1.598	B	M	4	16	K4M690		84039 <b>NEW</b>
	77	07/11 →	1.598	B	M	4	16	K4M690		81806
1.6 16V Bifuel	77	01/11 →	1.598	BF	M	4	16	K4M690, K4M694, K4M696		84039 <b>NEW</b>
	77	01/11 →	1.598	BF	M	4	16	K4M690, K4M694, K4M696		81806
1.6 MPI 85	62	05/10 →	1.598	B	M	4	8	K7M800		84039 <b>NEW</b>

### Sandero II

1.2	54	05/15 →	1.149	B	M	4	16	D4F732		82090
	55	10/12 →	1.149	B	M	4	16	D4F732		82090
1.2 LPG	55	10/12 →	1.149		M	4	16	D4F732		82090
1.5 dCi	55	10/12 →	1.461	D	M	4	8	K9K612		81810
	55	10/12 →	1.461	D	M	4	8	K9K612		84007
	63	01/13 →	1.461	D	M	4	8	K9K830		84007
	66	10/12 →	1.461	D	M	4	8	K9K612		81810
	66	10/12 →	1.461	D	M	4	8	K9K612		84007
1.6	61	11/12 →	1.598	B	M	4	8	K7M812		84039 <b>NEW</b>
	61	11/12 →	1.598	B	M	4	8	K7M812		81806
1.6 16V	77	01/13 →	1.598	B	M	4	16	K4M842, K4M845		84039 <b>NEW</b>
	77	01/13 →	1.598	B	M	4	16	K4M842, K4M845		81806
TCe 90	66	10/12 →	898	B	M	3	12	H4B400		84003

### Solenza

1.4	55	02/03 →	1.390	B	M	4	8	K7J710		81578
1.9 D	46	02/03 →	1.870	D	M	4	8	F8Q630		81574

## DAEWOO

### Cielo

1.5	66	06/94 → 07/98	1.498	B	M	4	16	V15L		81549
-----	----	---------------	-------	---	---	---	----	------	--	-------

### Espero

1.5 16V	65	10/93 → 09/94	1.498	B	M	4	16	A15MF		81780
	66	02/95 → 06/99	1.498	B	M	4	16	A15MF		81780
1.8	66	02/95 → 09/99	1.796	B	M	4	8	C18LE	→ 10-1995	81606
	70	02/95 → 06/99	1.796	B	M	4	8	C18LE	→ 10-1995	81606

**KW**

**cm<sup>3</sup>**

**NO. OF VALVES**

**MAGNETI MARELLI**
**DAEWOO**
**Espero**

2.0	74	10/91 → 09/93	1.998	B	M	4	8	C20LZ		81606
	77	02/95 → 06/99	1.998	B	M	4	8	C20LE	→ 10-1995	81606
	81	10/93 → 09/94	1.998	B	M	4	8	C20LE		81606

**Evanda**

2.0	96	08/02 →	1.998	B	M	4	16	L88, X20SED		81550
-----	----	---------	-------	---	---	---	----	-------------	--	-------

**Kalos**

1.2	53	04/03 →	1.150	B	M	4	8	B12S1, F12S3		81781
1.4	61	09/02 →	1.399	B	M	4	8	F14S3		81781
	69	05/03 → 12/04	1.399	B	M	4	16	F14D3		81782
1.4 16V	69	04/03 →	1.399	B	M	4	16	F14D3		81782
1.5	62	11/02 → 12/04	1.498	B	M	4	8	F15S		81781

**Korando, Cabrio**

2.3	105	01/99 →	2.295	B	M	4	16	M161.970		81509
2.9 D	72	01/99 →	2.874	D	M	5	10	MB-OM662		81506
2.9 TD	88	01/99 →	2.874	D	M	5	10	MB-OM60129TD		81506
3.2 4x4	156	01/99 →	3.199	B	M	6	24	M104.995		81722

**Lacetti II**

1.6	78	06/99 → 07/03	1.598	B	M	4	16	A16DMS		81782
-----	----	---------------	-------	---	---	---	----	--------	--	-------

**Lacetti III, Hatchback**

1.4	70	02/04 →	1.399	B	M	4	16	F14D3		81782
1.6	80	02/04 →	1.598	B	M	4	16	F16D3		81782
1.8	90	02/04 →	1.799	B	M	4	16	T18SED		81550
1.8 CDX	90	08/03 → 12/04	1.799	B	M	4	16	T18SED		81550

**Lanos**

1.4	55	05/97 →	1.349	B	M	4	8	A14SMS		81781
1.5	63	05/97 →	1.498	B	M	4	8	A15SMS	01-1997 →	81781
	63	05/97 →	1.498	B	M	4	8	A15SMS		81781
1.6 16V	78	05/97 →	1.598	B	M	4	16	A16DMS		81780

**Leganza**

2.0 16V	93	07/00 → 04/04	1.998	B	M	4	16	T20SED		81550
	98	06/97 → 12/02	1.998	B	M	4	16	X20SED		81550
2.2 16V	100	04/99 → 12/02	2.198	B	M	4	16	T22SED		81550

**Magnus**

2.0	96	07/99 →	1.998	B	M	4	16	X20SED		81550
-----	----	---------	-------	---	---	---	----	--------	--	-------

**Matiz**

0.8	38	09/98 →	796	B	M	3	6	F8CV		81783
1.0	47	01/03 →	995	B	M	4	8	B10S		81783

**Musso**

2.2 TD	74	09/99 →	2.299	D	M	4	8	MBOM601		81506
2.3	103	01/99 →	2.295	B	M	4	16	M111.970		81509
2.9 D 4x4	73	01/99 → 09/99	2.874	D	M	5	10	MB-OM662		81506
2.9 TD 4x4	88	01/99 →	2.874	D	M	5	10	MB-OM60129TD		81506
3.2 4x4	162	01/99 →	3.199	B	M	6	24	M104.992		81722

**KW**

**cm<sup>3</sup>**

**NO. OF VALVES**

## DAEWOO

### Nexia I

1.5	44	08/96 → 08/97	1.498	B	M	4	8	G15MF		81549
	52	02/95 → 08/97	1.498	B	M	4	8	G15MF		81549
	55	02/95 → 08/97	1.498	B	M	4	8	G15MF		81549
1.5 16V	66	02/95 → 08/97	1.498	B	M	4	16	A15MF		81780

### Nubira I, Station Wagon

1.6	76	08/02 → 07/03	1.598	B	M	4	16	A16DMS		81782
1.6 16V	66	06/97 →	1.598	B	M	4	16	A16SMS		81782
	76	07/00 →	1.598	B	M	4	16	A16DMS		81782
	78	05/97 →	1.598	B	M	4	16	A16DMS		81782
2.0	81	06/99 → 07/03	1.998	B	M	4	16	C20SED		81550
2.0 16V	93	12/00 →	1.998	B	M	4	16	T20SED		81550
	98	05/97 →	1.998	B	M	4	16	X20SED		81550
	98	05/97 →	1.998	B	M	4	16	X20SED, Z20L		81550

### Nubira II, Station Wagon

1.4	69	10/03 → 12/04	1.399	B	M	4	16	F14D3		81782
1.6	80	07/03 →	1.598	B	M	4	16	F16D3		81782
1.8	90	07/03 →	1.799	B	M	4	16	T18SED		81782

### Rezzo

1.6	77	09/00 →	1.598	B	M	4	16	A16DMS		81782
1.6 SX	66	08/01 → 12/04	1.598	B	M	4	16	A16SMS		81782
2.0	89	09/01 →	1.998	B	M	4	16	X20SED		81550
	94	09/00 →	1.998	B	M	4	16	T20SED		81550

### Tico II

0.8	35	02/95 → 12/00	796	B	M	3	6	F8C		81783
	38	01/96 → 12/00	796	B	M	3	6	F8CV		81783

### Tosca

2.0 TDCi	110	02/06 →	1.991	D	M	4	16	Z20DMH		84014
----------	-----	---------	-------	---	---	---	----	--------	--	-------

## DAIHATSU

### Applause I

1.6 16V	66	06/89 → 07/97	1.590	B	M	4	16	HD		81714
	77	06/89 → 07/97	1.590	B	M	4	16	HD-E		81714
1.6 16V 4WD	77	06/89 → 07/97	1.590	B	M	4	16	HD-E		81714

### Applause II

1.6 16V	73	07/97 → 05/00	1.590	B	M	4	16	HD-E		81714
---------	----	---------------	-------	---	---	---	----	------	--	-------

### Charade III

1.3	56	09/88 → 01/92	1.295	B	M	4	16	HC-C		81714
	66	11/90 → 02/93	1.296	B	M	4	16	HCE		81714
1.3 i	66	06/88 → 12/92	1.296	B	M	4	16	HCE		81714
1.3 i 4WD	66	06/88 → 01/93	1.296	B	M	4	16	HCE		81714

--	--	--	--	--	--	--	--	--	--	--

## DAIHATSU

### Charade IV

1.0	38	09/94 → 03/96	993	B	M	3	6	CB22		81714
1.3	44	09/96 → 11/99	1.296	B	M	4	16	HC		81714
1.3 16V	55	05/96 → 11/99	1.296	B	M	4	16	HCE		81714
1.3 i 16V	62	01/93 → 09/00	1.296	B	M	4	16	HC, HCE		81714
1.5 16V	55	10/94 →	1.499	B	M	4	16	HEE		81714
1.5 HG	55	06/94 → 03/96	1.499	B	M	4	16	HEE, HEEG		81714
1.5 i 16V	66	08/94 →	1.499	B	M	4	16	HEE		81714
	66	01/97 → 11/99	1.499	B	M	4	16	HEE, HEEG		81714
1.6 GTi	77	03/93 → 11/99	1.590	B	M	4	16	HD-E		81714

### Charade VI

1.33 16V	73	05/11 →	1.329	B	M	4	16	1NR-FE		84032
----------	----	---------	-------	---	---	---	----	--------	--	-------

### Copen

1.3	64	03/06 → 09/12	1.298	B	M	4	16	K3-VE	Flange: 3 holes	81808
-----	----	---------------	-------	---	---	---	----	-------	-----------------	-------

### Cuore XIII

1.0	51	04/07 →	998	B	M	3	12	1KR-FE		82063
-----	----	---------	-----	---	---	---	----	--------	--	-------

### Feroza Soft Top, Hard Top

1.6 16V	63	10/88 → 12/99	1.590	B	M	4	16	HDC		81715
1.6 i 16V	70	10/88 → 12/99	1.590	B	M	4	16	HD-E		81715
1.6 i 16V 4x4	70	10/88 → 12/99	1.590	B	M	4	16	HD-E		81715

### Gran Move

1.5 16V	66	10/96 → 07/98	1.499	B	M	4	16	HEEG		81714
1.6 16V	67	05/98 →	1.590	B	M	4	16	HDEP		81714
1.6 GLX	77	06/98 → 07/02	1.589	B	M	4	16	HDEP		81714
1.6 GX	67	06/98 → 07/02	1.589	B	M	4	16	HDEP		81714

### Hijet IV

1.3 i 16V	48	05/98 →	1.295	B	M	4	16	HCE		81714
-----------	----	---------	-------	---	---	---	----	-----	--	-------

### Materia

1.3	67	10/06 →	1.298	B	M	4	16	K3-VE	Flange: 3 holes	81808
1.3 DVVT Turbo	95	10/06 →	1.298	B	M	4	16	K3-VET	Flange: 3 holes	81808
1.5	76	10/06 →	1.495	B	M	4	16	3SZ-VE	Flange: 3 holes	81808
1.5 ECO 4WD	76	10/06 →	1.495	B	M	4	16	3SZ-VE	Flange: 3 holes	81808

### Rocky Soft Top, Hard Top

2.8 TD	67	12/87 → 04/93	2.765	D	M	4	8	DL51		81714
	75	09/91 → 12/98	2.765	D	M	4	8	DL52, DLT		81714

### Sirion I

1.3 Sport	75	08/00 → 01/05	1.298	B	AM	4	16	K3-VE2	Flange: 3 holes	81808
1.3 Sport 4WD	75	08/00 → 03/05	1.298	B	M	4	16	K3-VE2	Flange: 3 holes	81808

### Sirion II

1.0	51	01/05 →	998	B	M	3	12	1KR-FE		82063
1.0 DVVT 4WD	51	04/05 →	998	B	M	3	12	1KR-FE		82063
1.3	64	01/05 →	1.298	B	M	4	16	K3-VE	Flange: 3 holes	81808
	67	03/08 →	1.298	B	M	4	16	K3-VE	Flange: 3 holes	81808
1.3 4WD	64	04/05 →	1.298	B	M	4	16	K3-VE	Flange: 3 holes	81808
	67	03/08 →	1.298	B	M	4	16	K3-VE	Flange: 3 holes	81808

**KW**

**cm<sup>3</sup>**

**NO. OF VALVES**

**MAGNETI MARELLI**

## DAIHATSU

### Sirion II

1.5	76	03/08 →	1.495	B	M	4	16	3SZ-VE	Flange: 3 holes	81808
1.5 4WD	76	05/06 → 10/08	1.495	B	M	4	16	3SZ-VE	Flange: 3 holes	81808

### Storia

1.0	51	04/05 →	998	B	M	3	12	1KR-FE		82063
-----	----	---------	-----	---	---	---	----	--------	--	-------

### Terios I

1.3 4WD	61	10/97 → 10/00	1.296	B	M	4	16	HC-EJ		81715
---------	----	---------------	-------	---	---	---	----	-------	--	-------

### Terios II

1.3 VVT-i	63	11/05 →	1.298	B	M	4	16	K3-VE	Flange: 3 holes	81808
1.3 VVT-i 4x4	63	11/05 →	1.298	B	M	4	16	K3-VE	Flange: 3 holes	81808
1.5 4x4	77	05/06 →	1.495	B	M	4	16	3SZ-VE	Flange: 3 holes	81808
1.5 VVT-i	75	09/10 →	1.495	B	M	4	16	3SZ-VE	Flange: 3 holes	81808
	77	11/05 →	1.495	B	M	4	16	3SZ-VE	Flange: 3 holes	81808
1.5 VVT-i 4x4	75	09/10 →	1.495	B	M	4	16		Flange: 3 holes	81808

### YRV

1.3	64	02/01 →	1.298	B	AM	4	16	K3-VE	Flange: 3 holes	81808
1.3 4WD	64	02/01 →	1.298	B	AM	4	16	K3-VE	Flange: 3 holes	81808
1.3 GTi	95	07/02 →	1.298	B	A	4	16	K3-VET	Flange: 3 holes	81808

## DODGE

### Avenger

2.0 CRD	103	06/07 →	1.968	D	M	4	16	ECD		81816
	103	06/07 →	1.968	D	M	4	16	ECD		84011 <b>NEW</b>

### Caliber

2.0 CRD	103	06/06 →	1.968	D	M	4	16	ECD, ECE		81816
	103	06/06 →	1.968	D	M	4	16	ECD, ECE		84011 <b>NEW</b>

### Journey

2.0 CRD	103	06/08 →	1.968	D	M	4	16	ECE		81816
	103	06/08 →	1.968	D	M	4	16	ECE		84011 <b>NEW</b>

## DS

### DS 3

1.2 VTi 110	81	04/15 →	1.199	B	M	3	12			84066 <b>NEW</b>
1.2 VTi 82	60	04/15 →	1.199	B	M	3	12			84066 <b>NEW</b>
1.6 BlueHDi 100	73	04/15 →	1.560	D	M	4	8			81869
1.6 BlueHDi 120	88	07/15 →	1.560	D	M	4	8			81869
1.6 THP 165	121	07/15 →	1.598	B	M	4	16			82032

### DS 4 / DS 4 CROSSBACK

1.2 VTi	96	07/15 →	1.199	B	M	3	12			84066 <b>NEW</b>
1.6 BlueHDi 120	88	07/15 →	1.560	D	M	4	8			81869
1.6 THP 165	121	07/15 →	1.598	B	M	4	16			82032
2.0 BlueHDi 150	110	07/15 →	1.997	D	M	4	16			82068
2.0 BlueHDi 180	133	07/15 →	1.997	D	M	4	16			82068

--	--	--	--	--	--	--	--	--	--	--

## DS

### DS5

1.6 THP 210	155	04/15 →	1.598	B	M	4	16			82032
2.0 BlueHDi 150	110	04/15 →	1.997	D	M	4	16			82068
2.0 BlueHDi 180	133	04/15 →	1.997	D	M	4	16			82068
2.0 HDi 165 Hybrid4 4x4	120	04/15 →	1.997		M	4	16			84020

## FIAT

### 500 II, 500C

0.9	59	12/13 →	875	B	M	2	8	312A5.000		84008
	63	07/10 →	875	B	M	2	8	312A2.000		84008
	77	10/13 →	875	B	M	2	8	199B6.000		84008
	44	12/13 →	964	B	M	2	8	312A4.000, 312A6.000		84008
	48	09/12 →	964	B	M	2	8	312A4.000		84008
1.2	51	10/07 →	1.242	B	M	4	8	169A4.000	PIERBURG	81369
	51	10/07 →	1.242	B	M	4	8	169A4.000	TESMA	82070
1.2 LPG	51	12/10 →	1.242		M	4	8	169A4.000		84008
1.3 D Multijet	55	10/07 →	1.248	D	M	4	16	169A1.000		81862
	70	12/09 →	1.248	D	M	4	16	199B1.000		81862
1.4	74	10/07 →	1.368	B	M	4	16	169A3.000	PIERBURG	81369
	74	10/07 →	1.368	B	M	4	16	169A3.000	TESMA	82070

### 500L

0.9	77	09/12 →	875	B	M	2	8	199B6.000		84008
0.9 Natural Power	63	03/13 →	875		M	2	8	312A2.000		84008
1.3 D Multijet	62	09/12 →	1.248	D	M	4	16	199B4.000		81862
	70	06/14 →	1.248	D	M	4	16	330A1.000		81862
1.4	70	09/12 →	1.368	B	M	4	16	843A1.000	TESMA	82070
	88	10/13 →	1.368	B	M	4	16	940B7.000	TESMA	82070
1.4 LPG	88	02/14 →	1.368		M	4	16	940B7.000	TESMA	82070
1.6 D Multijet	77	09/12 →	1.598	D	M	4	16	199B5.000		81872
	88	09/13 →	1.598	D	M	4	16	940C1.000, 955A3.000		81872

### 500X

1.3 D Multijet	70	06/15 →	1.248	D	M	4	16	55266963		81862
1.4	100	09/14 →	1.368	B	M	4	16	55263624	TESMA	82070
	103	09/14 →	1.368	B	M	4	16	55263624	TESMA	82070
1.4 4x4	120	02/15 →	1.368	B	M	4	16	55263623	TESMA	82070
	125	02/15 →	1.368	B	M	4	16	55263623	TESMA	82070
1.6	81	11/14 →	1.598	B	M	4	16	55263842		81861
	82	09/14 →	1.598	B	M	4	16	55263842		81861
1.6 D Multijet	84	09/14 →	1.598	D	M	4	16	55260384		81872
	88	09/14 →	1.598	D	M	4	16	55260384		81872

**KW**

**cm<sup>3</sup>**

**NO. OF VALVES**

**MAGNETI MARELLI**
**FIAT**
**Barchetta**

1.8 16V	96	04/95 → 05/05	1.747	B	M	4	16	183A1.000, 188A6.000	→ 08-2000	81331
	96	04/95 → 05/05	1.747	B	M	4	16	183A1.000, 188A6.000	09-2000 →	81348

**Brava**

1.2 16V	64	12/98 → 12/02	1.242	B	M	4	16	182B2.000	PIERBURG	81369
1.2 16V 80	59	10/00 → 10/01	1.242	B	M	4	16	188A5.000	PIERBURG	81369
	60	12/98 → 12/02	1.242	B	M	4	16	182B2.000	→ 03-1999	81369
	60	12/98 → 12/02	1.242	B	M	4	16	182B2.000	04-1999 →, PIERBURG	81369
1.4	55	10/95 → 10/01	1.370	B	M	4	12	182A5.000	→ 12-1997, → M: 705.144	81340
	55	10/95 → 10/01	1.370	B	M	4	12	182A5.000	01-1998 →, M →: 705.145	81351
1.4 12 V	59	10/95 → 08/98	1.370	B	M	4	12	182A3.000	→ 12-1997, → M: 705.144	81340
	59	10/95 → 08/98	1.370	B	M	4	12	182A3.000	01-1998 →, M →: 705.145	81351
1.6 16V	66	10/95 → 10/01	1.581	B	M	4	16	182A6.000	(-)COP	81364
	66	10/95 → 10/01	1.581	B	M	4	16	182A6.000	(+)COP	81341
	76	02/96 → 10/01	1.581	B	M	4	16	182A4.000	(-)COP	81364
	76	02/96 → 10/01	1.581	B	M	4	16	182A4.000	(+)COP	81341
	76	01/99 → 12/02	1.596	B	M	4	16	182B6.000	(-)COP	81364
	76	01/99 → 12/02	1.596	B	M	4	16	182B6.000	(+)COP	81341
1.8 GT 16V	83	10/95 → 10/01	1.747	B	M	4	16	182A2.000	10-1995 →	81331
1.9 D	48	10/95 → 10/01	1.929	D	M	4	8	160A7.000	(-)COP	81372
	48	10/95 → 10/01	1.929	D	M	4	8	160A7.000	(+)COP	81342
1.9 JTD	74	09/00 → 10/01	1.910	D	M	4	8	182B9.000		81330
1.9 JTD 105	77	12/98 → 10/01	1.910	D	M	4	8	182B4.000		81352
1.9 TD 100 S	74	03/96 → 10/01	1.910	D	M	4	8	182A7.000	09-1996 →	81330
1.9 TD 75 S	55	03/96 → 10/01	1.910	D	M	4	8	182A8.000	09-1996 →	81352
2.0	113	09/98 → 08/00	1.998	B	M	5	20	182B7.000		81329

**Bravo I**

1.2 16V 80	59	10/00 → 10/01	1.242	B	M	4	16	188A5.000	PIERBURG	81369
	60	12/98 → 10/00	1.242	B	M	4	16	182B2.000	→ 03-1999	81369
	60	12/98 → 10/00	1.242	B	M	4	16	182B2.000	04-1999 →, PIERBURG	81369
	64	12/98 → 10/01	1.242	B	M	4	16	182B2.000	PIERBURG	81369
1.4	55	10/95 → 10/01	1.370	B	M	4	12	182A5.000	→ 12-1997, → M: 705.144	81340
	55	10/95 → 10/01	1.370	B	M	4	12	182A5.000	01-1998 →, M →: 705.145	81351
	59	10/95 → 10/01	1.370	B	M	4	12	182A3.000	→ 12-1997, → M: 705.144	81340
	59	10/95 → 10/01	1.370	B	M	4	12	182A3.000	01-1998 →, M →: 705.145	81351



**KW**

**cm<sup>3</sup>**

**NO. OF VALVES**

**FIAT**
**Bravo I**

1.6	76	09/00 → 10/01	1.596	B	M	4	16	182B6.000	(-)COP	81364
	76	09/00 → 10/01	1.596	B	M	4	16	182B6.000	(+)COP	81341
1.6 16V	66	10/95 → 10/01	1.581	B	M	4	16	182A6.000	(-)COP, 10-1995 →	81364
	66	10/95 → 10/01	1.581	B	M	4	16	182A6.000	(+)COP, 10-1995 →	81341
	76	03/96 → 10/01	1.581	B	M	4	16	182A4.000	(-)COP	81364
	76	03/96 → 10/01	1.581	B	M	4	16	182A4.000	(+)COP	81341
1.8 GT	83	10/95 → 10/01	1.747	B	M	4	16	182A2.000	10-1995 →	81331
1.9 D	48	10/95 → 10/01	1.929	D	M	4	8	160A7.000	(-)COP	81372
	48	10/95 → 10/01	1.929	D	M	4	8	160A7.000	(+)COP	81342
1.9 JTD	74	09/00 → 10/01	1.910	D	M	4	8	182B9.000		81330
1.9 JTD 105	77	12/98 → 10/01	1.910	D	M	4	8	182B4.000		81352
1.9 TD 100 S	74	03/96 → 10/01	1.910	D	M	4	8	182A7.000	09-1996 →	81330
1.9 TD 75 S	55	03/96 → 10/01	1.910	D	M	4	8	182A8.000	09-1996 →	81352
2.0 HGT 20V	108	10/95 → 07/98	1.998	B	M	5	20	182A1.000	10-1995 →	81329
	113	07/98 → 10/01	1.998	B	M	5	20	182B7.000		81329

**Bravo II, Van**

1.4	66	04/07 →	1.368	B	M	4	16	192B2.000	PIERBURG	81369
	66	04/07 →	1.368	B	M	4	16	192B2.000	TESMA	82070
1.4 16V	103	03/08 →	1.368	B	M	4	16	198A7.000	TESMA	82070
1.4 LPG	66	11/09 →	1.368		M	4	16	192B2.000	TESMA	82070
1.4 T-Jet	88	09/07 →	1.368	B	M	4	16	198A4.000	PIERBURG	81369
	88	09/07 →	1.368	B	M	4	16	198A4.000	TESMA	82070
	110	09/07 →	1.368	B	M	4	16	198A1.000	PIERBURG	81369
	110	09/07 →	1.368	B	M	4	16	198A1.000	TESMA	82070
1.6 D Multijet	66	03/08 →	1.598	D	M	4	16	198A6.000		81872
	77	03/08 →	1.598	D	M	4	16	198A3.000		81872
	77	09/07 →	1.598	D	M	4	16	198A3.000, 844A3.000		81872
	85	11/08 →	1.598	D	M	4	16	955A4.000		81872
	88	03/08 →	1.598	D	M	4	16	198A2.000		81872
1.9 D Multijet	66	04/07 → 12/08	1.910	D	M	4	8	192B5.000		81352
	85	11/06 →	1.910	D	M	4	8	192A1.000, 192B4.000		81352
	88	04/07 →	1.910	D	M	4	8	192A8.000		81352
	110	04/07 →	1.910	D	M	4	16	937A5.000		81872
2.0 D Multijet	120	09/08 →	1.956	D	M	4	16	198A8.000, 844A2.000		81872
	121	09/08 →	1.956	D	M	4	16	198A5.000		81872

**Cinquecento**

0.9	30	07/91 → 12/93	903	B	M	4	8	170A1.000	(-)JAC	81300
	30	07/91 → 12/93	903	B	M	4	8	170A1.000	(+)JAC	81301
0.9 i.e.	30	07/91 → 12/93	903	B	M	4	8	170A1.046	(-)JAC	81300
	30	07/91 → 12/93	903	B	M	4	8	170A1.046	(+)JAC	81301
0.9 i.e. S	29	07/91 → 07/99	899	B	M	4	8	1170A1.000, 1170A1.046		81301
1.1 Sporting	40	10/94 → 01/98	1.108	B	M	4	8	176B2.000		81801

**KW**

**cm<sup>3</sup>**

**NO. OF VALVES**

**FIAT**
**Coupé**

1.8 16V	96	03/96 → 08/00	1.747	B	M	4	16	183A1.000		81331
2.0 16V	102	11/93 → 08/96	1.995	B	M	4	16	836A3.000	02-1994 →	81322
2.0 16V Turbo	140	11/93 → 08/96	1.995	B	M	4	16	175A1.000	02-1994 →	81322
2.0 20V	108	08/96 → 04/98	1.998	B	M	5	20	182A1.000	09-1996 →	81329
	113	04/98 → 08/00	1.998	B	M	5	20	182B3.000		81329
2.0 20V Turbo	162	08/96 → 08/00	1.998	B	M	5	20	175A3.000	09-1996 →	81329

**Croma I**

1900 Turbo D i.d.	66	05/89 → 10/92	1.929	D	M	4	8	154C6.000	T →: 286.050	81309
2000 16V	101	08/92 → 08/96	1.995	B	M	4	16	154E1.000		81490
2000 CHT	74	01/91 → 09/92	1.995	B	M	4	8	154A1.000, 154C5.000		81443

2000 i.e.	83	03/86 → 09/90	1.995	B	M	4	8	834B.048	08-1986 →, → 02-1991, → T: 285.921	81443
	85	10/87 → 08/96	1.995	B	M	4	8	154C3.046, 834B.146	→ 02-1991, → T: 285.921	81443
	85	10/87 → 08/96	1.995	B	M	4	8	154C3.046, 834B.146	03-1991 →, T →: 285.922	81460
	88	03/87 → 09/92	1.995	B	M	4	8	154C3.000, 834B.000	→ 02-1991, → T: 285.921	81443
	88	03/87 → 09/92	1.995	B	M	4	8	154C3.000, 834B.000	03-1991 →, T →: 285.922	81460

2000 i.e. Turbo	110	06/87 → 08/96	1.995	B	M	4	8	154C4.046, 834C.146	→ 02-1991, → T: 285.921	81443
	110	06/87 → 08/96	1.995	B	M	4	8	154C4.046, 834C.146	04-1991 →, T →: 285.922	81460
	114	12/85 → 06/90	1.995	B	M	4	8	154A2.000		81443

2500 TD	85	05/89 → 08/96	2.500	D	M	4	8	8144.97, 8144.97.2400, 8144.97Y	01-1993 →	81325
	85	05/89 → 08/96	2.500	D	M	4	8	8144.97, 8144.97.2400, 8144.97Y	10-1991 →, → 12-1992, → M: 1.340.163	81324

2500 TDE	77	12/91 → 08/96	2.500	D	M	4	8	8144.97S	→ 12-1992, M →: 1.340.163	81324
	77	12/91 → 08/96	2.500	D	M	4	8	8144.97S	01-1993 →	81325

2500 V6	119	06/93 → 08/96	2.492	B	M	6	12	834G.000		19532/E
---------	-----	---------------	-------	---	---	---	----	----------	--	---------

**Croma II**

1.8 16V	103	12/05 →	1.796	B	M	4	16	939A4.000		82083
1.9 D Multijet	85	06/05 →	1.910	D	M	4	8	939A7.000		81352
	88	06/05 →	1.910	D	M	4	8	939A1.000		81352
	100	12/05 →	1.910	D	M	4	16	939A8.000		81872
	110	06/05 →	1.910	D	M	4	16	939A2.000		81872
2.2 16V	108	06/05 →	2.198	B	M	4	16	194A1.000		81812
2.4 D Multijet	147	06/05 →	2.387	D	M	5	20	939A3.000		81872

**KW**

**cm<sup>3</sup>**

**NO. OF VALVES**

**MAGNETI MARELLI**
**FIAT**
**Doblò I, Cargo**

1.2	48	03/01 →	1.242	B	M	4	8	223A5.000	MAGMA	81370
1.3 D Multijet	55	10/05 → 01/10	1.248	D	M	4	16	199A2.000		81862
	62	10/05 →	1.248	D	M	4	16	223A9.000		81862
1.3 JTD	55	05/05 →	1.248	D	M	4	16	199A2.000		81862
1.3 JTD 16V	51	05/04 → 12/06	1.248	D	M	4	16	188A8.000, 188A9.000		81862
	51	12/04 → 05/05	1.248	D	M	4	16	188A9.000		81862
1.3 JTD 16V Multijet	62	08/06 →	1.248	D	M	4	16	223A9.000		81862
1.4	57	10/05 →	1.368	B	M	4	8	350A1.000	PIERBURG	81369
	57	10/05 →	1.368	B	M	4	8	350A1.000	TESMA	82070
1.6	68	09/02 →	1.596	B	M	4	16	182B6.000	(-)COP	81364
	68	09/02 →	1.596	B	M	4	16	182B6.000	(+)COP	81341
1.6 16V	76	10/01 →	1.596	B	M	4	16	182B6.000	(-)COP	81364
	76	10/01 →	1.596	B	M	4	16	182B6.000	(+)COP	81341
1.6 Natural Power	76	09/02 →	1.596		M	4	16	182B6.000	(-)COP	81364
	76	09/02 →	1.596		M	4	16	182B6.000	(+)COP	81341
1.9 D	46	03/01 →	1.910	D	M	4	8	223A6.000		81352
1.9 D Multijet	88	10/05 →	1.910	D	M	4	8	186A9.000		81352
1.9 JTD	77	07/03 →	1.910	D	M	4	8	223A7.000, 223B1.000		81352
	74	10/01 →	1.910	D	M	4	8	182B9.000		81352
	74	10/01 →	1.910	D	M	4	8	182B9.000, 223B2.000		81352
1.9 JTD Multijet	88	12/06 →	1.910	D	M	4	8	186A9.000		81352

**Doblò II, Cargo**

1.3 D Multijet	66	02/10 →	1.248	D	M	4	16	199A3.000, 263A2.000		81862
1.4	70	02/10 →	1.368	B	M	4	16	843A1.000	TESMA	82070
	70	04/10 →	1.368	B	M	4	16	843A1.000	(-)COP	84038 <b>NEW</b>
	70	04/10 →	1.368	B	M	4	16	843A1.000	(+)COP	82089
	70	04/10 →	1.368	B	M	4	16	843A1.000		82089
	88	10/11 →	1.368	B	M	4	16	198A4.000	TESMA	82070
1.4 Natural Power	88	06/10 →	1.368		M	4	16	198A4.000	TESMA	82070
1.6 D Multijet	66	02/10 →	1.598	D	M	4	16	263A4.000		81872
	66	02/10 →	1.598	D	M	4	16	263A4.000, 263A5.000		81872
	74	02/10 →	1.598	D	M	4	16	263A3.000		81872
	77	02/10 →	1.598	D	M	4	16	198A3.000		81872
2.0 D Multijet	99	02/10 →	1.956	D	M	4	16	263A1.000		81872

**Ducato I**

1.9 D	52	01/88 → 08/90	1.929	D	M	4	8	149B1.000		81489
1.9 TD	60	03/89 → 08/90	1.929	D	M	4	8	280A1.000		81489
2.0	55	07/85 → 08/90	1.971	B	M	4	8	170B		81367
	55	07/85 → 08/90	1.971	B	M	4	8	170B, XN1T		81367
	58	01/82 → 08/90	1.971	B	M	4	8	XN1T		81367
	62	03/89 → 08/90	1.971	B	M	4	8	170D		81367
2.4 D	53	01/82 → 08/90	2.428	D	M	4	8	8144.61	→ 09-1986	81492
	53	01/82 → 08/90	2.428	D	M	4	8	8144.61	10-1986 →	81488

**KW**

**cm<sup>3</sup>**

**NO. OF VALVES**

**FIAT**
**Ducato I**

2.5 D	55	01/82 → 08/90	2.500	D	M	4	8	8144.67, CRD93L (U25-661)		81822
2.5 D 4x4	55	03/89 → 08/90	2.500	D	M	4	8	8144.67		81488
2.5 TD	68	01/86 → 08/90	2.445	D	M	4	8	8144.21		81488
	68	01/87 → 08/90	2.445	D	M	4	8	8144.21, 8144.21.220		81488
2.5 TD 4x4	68	01/86 → 08/90	2.445	D	M	4	8	8144.21		81488
	70	09/86 → 05/90	2.499	D	M	4	8	8140.27		81488

**Ducato II**

1.9 D	52	07/90 → 03/94	1.929	D	M	4	8	149B1.000		81489
1.9 TD	60	03/89 → 03/94	1.929	D	M	4	8	280A1.000		81489
2.0	62	07/90 → 03/94	1.971	B	M	4	8	170D		81367
2.0 4x4	63	06/90 → 05/94	1.971	B	M	4	8	170D		81367
2.5 D	55	07/90 → 03/94	2.500	D	M	4	8	8144.67		81488
2.5 D 4x4	55	07/90 → 03/94	2.500	D	M	4	8	8144.67		81488
2.5 TD	70	07/90 → 03/94	2.500	D	M	4	8	8140.27		81488
2.5 TD 4x4	70	07/90 → 03/94	2.500	D	M	4	8	8140.27		81488

**Ducato III**

1.9 D	50	04/98 → 04/02	1.905	D	M	4	8	D9B, D9B (XUD9A), DJY		81642
	50	04/98 → 04/02	1.905	D	M	4	8	DJY		81642
	51	03/94 → 04/02	1.929	D	M	4	8	230A2.000	03-1994 →	81320
1.9 D Combinato	51	06/95 → 04/02	1.929	D	M	4	8	230A2.000		81320
1.9 TD	66	04/98 → 04/02	1.905	D	M	4	8	DHX (XUD9TF/L)		81642
	60	03/94 → 04/02	1.929	D	M	4	8	230A3.000	(-)AC	81318
	60	03/94 → 04/02	1.929	D	M	4	8	230A3.000	(+)AC	81319
1.9 TD CAT	59	08/94 → 04/02	1.929	D	M	4	8	230A4.000	(-)AC	81318
	59	08/94 → 04/02	1.929	D	M	4	8	230A4.000	(+)AC	81319
1.9 TD Combinato	59	08/94 → 04/02	1.929	D	M	4	8	230A4.000	(-)AC	81318
	59	08/94 → 04/02	1.929	D	M	4	8	230A4.000	(+)AC	81319
1.9 TD Panorama/ Combinato	60	03/94 → 04/02	1.929	D	M	4	8	230A3.000	(-)AC	81318
	60	03/94 → 04/02	1.929	D	M	4	8	230A3.000	(+)AC	81319
2.0	80	03/94 → 04/02	1.998	B	M	4	8	RFW		81642
2.0 4x4	80	11/94 → 11/01	1.998	B	M	4	8	RFW		81642
2.0 JTD	62	10/01 → 04/02	1.997	D	M	4	8	RHV (DW10)		81713
2.0 Panorama/ Combinato	80	03/94 → 04/02	1.998	B	M	4	8	RFW		81642
2.5 D	62	03/94 → 04/02	2.500	D	M	4	8	8140.67		81316
2.5 D 4x4	62	03/94 → 04/02	2.500	D	M	4	8	8140.67		81316
2.5 D Combinato	62	08/94 → 04/02	2.500	D	M	4	8	8140.67		81316
2.5 TD	80	06/94 → 08/98	2.499	D	M	4	8	8140.47		81316
	85	06/94 → 04/98	2.499	D	M	4	8	8140.47		81316
2.5 TD 4x4	80	11/94 → 04/98	2.499	D	M	4	8	8140.47		81316
	85	11/94 → 04/98	2.499	D	M	4	8	8140.47		81316

--	--	--	--	--	--	--	--	--	--

## FIAT

### Ducato III

2.5 TDI	80	03/94 → 04/02	2.500	D	M	4	8	8140.47R		81316
	85	03/94 → 04/02	2.500	D	M	4	8	8140.47		81316
2.5 TDI 4x4	85	04/97 → 04/02	2.500	D	M	4	8	8140.47		81316
2.5 TDI Panorama/ Combinato	80	07/94 → 04/02	2.500	D	M	4	8	8140.47R		81316
	85	03/94 → 04/02	2.500	D	M	4	8	8140.47		81316
2.8 D	64	02/98 → 04/02	2.800	D	M	4	8	8140.63		81316
2.8 D 4x4	64	08/98 → 04/02	2.800	D	M	4	8	8140.63		81316
2.8 IDTD 4x4	90	05/98 → 09/01	2.799	D	M	4	8	8140.43		81316
2.8 JTD	94	11/00 → 04/02	2.798	D	M	4	8	8140.43S		81316
	94	03/01 → 04/02	2.799	D	M	4	8	8140.43S		81316
2.8 JTD 4x4	94	11/00 → 04/02	2.798	D	M	4	8	8140.43S		81316
	94	10/01 → 04/02	2.799	D	M	4	8	8140.43S		81316
2.8 TD 4x4	64	05/98 → 11/01	2.799	D	M	4	8	8140.63		81316
	90	05/98 → 09/01	2.799	D	M	4	8	8140.43		81316
2.8 TDI	90	10/97 → 04/02	2.800	D	M	4	8	8140.43		81316
2.8 TDI 4x4	90	07/99 → 04/02	2.800	D	M	4	8	8140.43		81316

### Ducato IV

2.0	81	04/02 →	1.998	B	M	4	16	RFL		81642
2.0 4x4	81	05/02 → 07/06	1.998	B	M	4	16	RFL		81642
2.0 Bipower	81	11/02 →	1.998		M	4	16	RFL		81642
2.0 JTD	62	04/02 →	1.997	D	M	4	8	RHV (DW10)		81713
2.3 JTD	81	04/02 →	2.286	D	M	4	16	F1AE0481C		82024
2.8 JTD	94	04/02 →	2.798	D	M	4	8	8140.43S		81316
	107	04/04 → 07/06	2.800	D	M	4	8	8140.43N		81316
2.8 JTD 4x4	94	07/02 →	2.798	D	M	4	8	8140.43S		81316
2.8 JTD Power	107	05/04 →	2.800	D	M	4	8	8140.43N		81316

### Ducato V

100 Multijet 2,2 D	74	07/06 →	2.198	D	M	4	16	4HV		82066
110 Multijet 2,3 D	83	10/11 →	2.287	D	M	4	16	F1AE3481G		82024
115 Multijet 2,0 D	85	06/11 →	1.956	D	M	4	16	250A1.000, 250A2.000		82094
	85	06/11 →	1.956	D	M	4	16	250A1.000, 250A2.000		81872
120 Multijet 2,3 D	88	07/06 →	2.287	D	M	4	16	F1AE0481D		82024
	88	07/06 →	2.287	D	M	4	16	F1AE0481D, FPT		82024
120 Multijet 2,3 D 4x4	88	03/10 →	2.287	D	M	4	16	F1AE0481D		82024
	88	03/10 →	2.287	D	M	4	16	F1AE0481D		81872
130 Multijet 2,3 D	93	08/06 →	2.287	D	M	4	16	F1AE0481T		82024
	96	01/07 →	2.287	D	M	4	16	F1AE0481N, F1AE3481D, F1AGL411D		82024
	96	01/07 →	2.287	D	M	4	16	F1AE3481D, F1AGL411D		82024
140 Natural Power	100	04/09 →	2.999		M	4	16	F1CE0441A		82094
	100	04/09 →	2.999		M	4	16	F1CE0441A, F1CFA401A		82094

**KW**

**cm<sup>3</sup>**

**NO. OF VALVES**

**MAGNETI MARELLI**
**FIAT**
**Ducato V**

150 Multijet 2,3 D	109	06/11 →	2.287	D	M	4	16	F1AE3481E		82024
	107	04/10 →	2.999	D	M	4	16	F1CE3481N		82094
160 Multijet 3,0 D	115	10/06 →	2.999	D	M	4	16	F1CE0481D		82094
	115	07/06 →	2.999	D	M	4	16	F1CE3481M		82094
	116	07/06 →	2.999	D	M	4	16	F1CE0481D		82094
	116	07/06 →	2.999	D	M	4	16	F1CE0481D, F1CE3481M		82094
180 Multijet 3,0 D	130	06/11 →	2.999	D	M	4	16	F1CE3481E		82094

**Duna I, Weekend**

1.7 DS	44	01/87 → 12/91	1.698	D	M	4	8	149B3.000	(+)COP	81456
60 1.1	43	01/87 → 12/91	1.116	B	M	4	8	146A6.000		81434
70 1.3	49	01/87 → 12/91	1.301	B	M	4	8	146A5.000		81434

**Elba**

1.3	43	04/86 → 12/93	1.297	B	M	4	8	127A2.011		81434
1.3 D	33	04/86 → 10/92	1.301	D	M	4	8	127A5.000		81434
1.5	52	04/86 → 10/92	1.499	B	M	4	8	149C1.000	(+)COP, (+)AC	81303
1.7 D	43	04/89 → 12/96	1.698	D	M	4	8	146B2.000	(+)COP, (-)SS, (-)AC	81456
	43	04/89 → 12/96	1.698	D	M	4	8	146B2.000	(+)SS, (+)AC	81344

**Fiorino II, Pick Up (147)**

1.3	49	12/87 → 08/93	1.301	B	M	4	8	146A5.000		81434
1.7 D	42	01/88 → 10/93	1.697	D	M	4	8	149B2.000	(+)COP	81456
	44	12/87 → 12/90	1.698	D	M	4	8	149B3.000	(+)COP	81456

**Fiorino III, Pick Up (Uno)**

1.3	49	01/88 → 12/94	1.301	B	M	4	8	146A5.000		81434
1.4	49	05/94 → 05/01	1.372	B	M	4	8	146D5.000	(-)COP, → M: 9.470.268	81314
	49	05/94 → 05/01	1.372	B	M	4	8	146D5.000	(-)COP, M →: 9.470.269	81366
	49	05/94 → 05/01	1.372	B	M	4	8	146D5.000	(+)COP, → M: 9.470.268	81476
	49	05/94 → 05/01	1.372	B	M	4	8	146D5.000	(+)COP, M →: 9.470.269	81343
	52	11/92 → 10/96	1.372	B	M	4	8	146C5.000	(-)COP, → M: 9.470.268	81314
	52	11/92 → 10/96	1.372	B	M	4	8	146C5.000	(-)COP, M →: 9.470.269	81366
	52	11/92 → 10/96	1.372	B	M	4	8	146C5.000	(+)COP, → M: 9.470.268	81476
	52	11/92 → 10/96	1.372	B	M	4	8	146C5.000	(+)COP, M →: 9.470.269	81343

**KW**

**cm<sup>3</sup>**

**NO. OF VALVES**

**MAGNETI MARELLI**
**FIAT**
**Fiorino III, Pick Up (Uno)**

1.6	55	01/94 → 05/01	1.581	B	M	4	8	146C6.000, 146D6.000	(-)COP, → M: 9.470.268	81314
	55	01/94 → 05/01	1.581	B	M	4	8	146C6.000, 146D6.000	(-)COP, M →: 9.470.269	81366
	55	01/94 → 05/01	1.581	B	M	4	8	146C6.000, 146D6.000	(+)COP, → M: 9.470.268	81476
	55	01/94 → 05/01	1.581	B	M	4	8	146C6.000, 146D6.000	(+)COP, M →: 9.470.269	81343
1.7 D	42	10/93 → 10/99	1.697	D	M	4	8	146B2.000	(+)COP, (-)SS, (-)AC	81456
	42	10/93 → 10/99	1.697	D	M	4	8	146B2.000	(+)SS, (+)AC	81344
	44	01/88 → 10/99	1.697	D	M	4	8	146B2.000	(+)COP, (-)SS, (-)AC	81456
	44	01/88 → 10/99	1.697	D	M	4	8	146B2.000	(+)SS, (+)AC	81344
	44	05/88 → 10/99	1.698	D	M	4	8	149B3.000	(+)COP, (-)SS, (-)AC	81456
	44	05/88 → 10/99	1.698	D	M	4	8	149B3.000	(+)SS, (+)AC	81344
1.7 TD	46	11/96 → 05/00	1.697	D	M	4	8	146D7.000		81344
	46	01/97 → 05/01	1.698	D	M	4	8	146D7.000		81344
60 1.1	40	05/88 → 12/93	1.116	B	M	4	8	146A9.000		81434
60 1.7 D	42	05/88 → 10/96	1.697	D	M	4	8	146B2.000	(+)COP, (-)SS, (-)AC	81456
	42	05/88 → 10/96	1.697	D	M	4	8	146B2.000	(+)SS, (+)AC	81344
	44	05/88 → 05/00	1.698	D	M	4	8	149B3.000	(+)COP, (-)SS, (-)AC	81456
	44	05/88 → 05/00	1.698	D	M	4	8	149B3.000	(+)SS, (+)AC	81344
65 1.7 TD	46	01/97 → 05/01	1.698	D	M	4	8	146D7.000		81344
70 1.3	49	01/88 → 12/94	1.301	B	M	4	8	146A5.000		81434
70 i.e. 1.4	49	05/94 → 05/01	1.372	B	M	4	8	146C5.000, 146D5.000	(-)COP, → M: 9.470.268	81314
	49	05/94 → 05/01	1.372	B	M	4	8	146C5.000, 146D5.000	(-)COP, M →: 9.470.269	81366
	49	05/94 → 05/01	1.372	B	M	4	8	146C5.000, 146D5.000	(+)COP, → M: 9.470.268	81476
	49	05/94 → 05/01	1.372	B	M	4	8	146C5.000, 146D5.000	(+)COP, M →: 9.470.269	81343
75 i.e. 1.6	55	10/93 → 05/01	1.581	B	M	4	8	146C6.000, 146D6.000	(-)COP, → M: 9.470.268	81314
	55	10/93 → 05/01	1.581	B	M	4	8	146C6.000, 146D6.000	(-)COP, M →: 9.470.269	81366
	55	10/93 → 05/01	1.581	B	M	4	8	146C6.000, 146D6.000	(+)COP, → M: 9.470.268	81476
	55	10/93 → 05/01	1.581	B	M	4	8	146C6.000, 146D6.000	(+)COP, M →: 9.470.269	81343
<b>Fiorino IV</b>										
1.3 D Multijet	55	11/07 →	1.248	D	M	4	16	199A2.000, 199A9.000		81862
	70	07/09 →	1.248	D	M	4	16	199B1.000, 330A1.000		81862
1.4	54	11/07 →	1.360	B	M	4	8	KFT, KFV		81797
1.4 Natural Power	57	10/09 →	1.368		M	4	8	350A1.000	TESMA	82070

**KW**

**cm<sup>3</sup>**

**NO. OF VALVES**

**FIAT**
**Freemont**

2.0 JTD	100	08/11 →	1.956	D	M	4	16	939B5.000		81872
	103	08/11 →	1.956	D	M	4	16	939B5.000, 940A5.000		81872
	120	08/11 →	1.956	D	M	4	16	939B5.000		81872
	125	08/11 →	1.956	D	M	4	16	939B5.000		81872
2.0 JTD 4x4	120	08/11 →	1.956	D	M	4	16	939B5.000		81872
	125	08/11 →	1.956	D	M	4	16	939B5.000		81872

**Grande Punto, Van**

1.2	48	10/05 →	1.242	B	M	4	8	199A4.000	PIERBURG	81369
	48	10/05 →	1.242	B	M	4	8	199A4.000	TESMA	82070
	51	09/10 →	1.242	B	M	4	8	169A4.000	TESMA	82070
1.2 LPG	51	07/08 →	1.242		M	4	8	199A4.000	TESMA	82070
1.3 D Multijet 1.3 D Multijet	51	07/08 →	1.248	D	M	4	16	199B2.000		81862
	55	10/05 →	1.248	D	M	4	16	199A2.000		81862
	56	06/09 →	1.248	D	M	4	16	199A2.000		81862
	62	04/10 →	1.248	D	M	4	16	199B4.000, 223A9.000		81862
	66	10/05 →	1.248	D	M	4	16	199A3.000		81862
1.4	55	06/06 →	1.368	B	M	4	8	199A7.000	TESMA	82070
	57	10/05 →	1.368	B	M	4	8	350A1.000	PIERBURG	81369
	57	10/05 →	1.368	B	M	4	8	350A1.000	TESMA	82070
1.4 16V	70	10/05 →	1.368	B	M	4	16	199A6.000	PIERBURG	81369
	70	10/05 →	1.368	B	M	4	16	199A6.000	TESMA	82070
	112	09/07 → 07/12	1.368	B	M	4	16	198A1.000	TESMA	82070
1.4 LPG	57	12/08 →	1.368		M	4	8	350A1.000	TESMA	82070
1.4 Natural Power	57	07/08 →	1.368		M	4	8	350A1.000	PIERBURG	81369
1.4 T-Jet	88	09/07 →	1.368	B	M	4	16	198A4.000	PIERBURG	81369
	88	09/07 →	1.368	B	M	4	16	198A4.000	TESMA	82070
1.6 D Multijet	88	07/08 →	1.598	D	M	4	16	955A3.000		81872
1.9 D Multijet	85	06/06 →	1.910	D	M	4	8	939A7.000		81872
	88	10/05 →	1.910	D	M	4	8	939A1.000		81352
	96	10/05 →	1.910	D	M	4	8	199A5.000		81352

**Idea**

1.2 16V	59	01/04 →	1.242	B	M	4	16	188A5.000	PIERBURG	81369
	59	01/04 →	1.242	B	M	4	16	188A5.000	TESMA	82070
1.3 D Multijet	66	10/05 →	1.248	D	M	4	16	199A3.000		81862
	70	05/08 →	1.248	D	M	4	16	199B1.000		81862
1.3 JTD	51	01/04 →	1.248	D	M	4	16	188A9.000		81862
1.4	57	10/05 →	1.368	B	M	4	8	350A1.000	PIERBURG	81369
	57	10/05 →	1.368	B	M	4	8	350A1.000	TESMA	82070
	66	12/03 →	1.368	B	M	4	16	192B2.000	PIERBURG	81369
1.4 16V	70	01/04 →	1.368	B	M	4	16	843A1.000	PIERBURG	81369
	70	01/04 →	1.368	B	M	4	16	843A1.000	TESMA	82070
1.4 LPG	57	03/09 →	1.368		M	4	8	350A1.000	TESMA	82070
1.6 D Multijet	88	05/08 →	1.598	D	M	4	16	350A2.000		81872
1.9 JTD	74	01/04 →	1.910	D	M	4	8	188B2.000		81352



**KW**

**cm<sup>3</sup>**

**NO. OF VALVES**

**FIAT**
**Linea**

1.3 D Multijet	66	06/07 →	1.248	D	M	4	16	199A3.000		81862
	70	09/09 →	1.248	D	M	4	16	199A3.000		81862
1.4	57	06/07 →	1.368	B	M	4	8	350A1.000	PIERBURG	81369
1.4	57	06/07 →	1.368	B	M	4	8	350A1.000	TESMA	82070
1.4 T-Jet	88	09/07 →	1.368	B	M	4	16	198A4.000	PIERBURG	81369
	88	09/07 →	1.368	B	M	4	16	198A4.000	TESMA	82070
1.6 D Multijet	77	06/09 →	1.598	D	M	4	16	198A3.000		81872

**Marea, Weekend**

1.2 16V	60	10/98 → 05/02	1.242	B	M	4	16	182B2.000	PIERBURG	81369
1.4 80 12V	59	09/96 → 05/02	1.370	B	M	4	12	182A3.000	→ 12-1997, → M: 705.144	81340
	59	09/96 → 05/02	1.370	B	M	4	12	182A3.000	01-1998 →, M →: 705.145	81351
1.6	68	03/99 → 08/00	1.581	B	M	4	16	185A3.000	(-)COP	81364
	68	03/99 → 08/00	1.581	B	M	4	16	185A3.000	(+)COP	81341
	76	09/00 → 08/02	1.596	B	M	4	16	182B6.000	(-)COP	81364
	76	09/00 → 08/02	1.596	B	M	4	16	182B6.000	(+)COP	81341
1.6 100 16V	76	09/96 → 05/02	1.581	B	M	4	16	182A4.000	(-)COP	81364
	76	09/96 → 05/02	1.581	B	M	4	16	182A4.000	(+)COP	81341
1.6 100 16V Bipower	76	04/99 → 05/02	1.581		M	4	16	185A3.000, 186A4.000	(-)COP	81364
	76	04/99 → 05/02	1.581		M	4	16	185A3.000, 186A4.000	(+)COP	81341
1.6 16V	75	04/97 → 02/99	1.581	B	M	4	16	185A3.000	(-)COP	81364
	75	04/97 → 02/99	1.581	B	M	4	16	185A3.000	(+)COP	81341
1.6 SX	72	09/00 → 08/02	1.581	B	M	4	16	182B5.098	(-)COP	81364
	72	09/00 → 08/02	1.581	B	M	4	16	182B5.098	(+)COP	81341
1.8 115 16V	83	09/96 → 05/02	1.747	B	M	4	16	182A2.000		81331
1.9 JTD 105	77	04/99 → 01/01	1.910	D	M	4	8	182B4.000		81352
1.9 JTD 110	81	01/01 → 05/02	1.910	D	M	4	8	186A6.000		81352
1.9 TD 100	74	09/96 → 05/02	1.910	D	M	4	8	182A7.000		81330
	74	09/96 → 05/02	1.910	D	M	4	8	182A7.000, 182B9.000		81330
1.9 TD 75	55	09/96 → 05/02	1.910	D	M	4	8	182A8.000	(+)COP, 05-1999 →	81303
	55	09/96 → 05/02	1.910	D	M	4	8	182A8.000	→ 04-1999	81330
	55	09/96 → 05/02	1.910	D	M	4	8	182A8.000	05-1999 →	81352
2.0 150 20V	108	09/96 → 04/99	1.998	B	M	5	20	182A1.000	10-1996 →	81329
	110	01/01 → 05/02	1.998	B	M	5	20	185A8.000		81329
	113	04/99 → 01/01	1.998	B	M	5	20	182B7.000		81329
2.4 JTD 130	96	04/99 → 05/02	2.387	D	M	5	10	185A6.000, 839A5.000		81330
	96	04/99 → 05/02	2.387	D	M	5	10	185A6.000, 839A5.000		81352
2.4 TD 125	91	09/96 → 04/99	2.387	D	M	5	10	185A2.000	11-1996 →	81330

**KW**

**cm<sup>3</sup>**

**NO. OF VALVES**

**MAGNETI MARELLI**
**FIAT**
**Multipla**

1.6	68	05/04 → 08/05	1.596	G	M	4	16	182B6.000	(-)COP	81364
	68	05/04 → 08/05	1.596	G	M	4	16	182B6.000	(+)COP	81341
	74	03/01 → 08/05	1.596	G	M	4	16	182B6.000	(-)COP	81364
	74	03/01 → 08/05	1.596	G	M	4	16	182B6.000	(+)COP	81341
	76	09/00 → 06/10	1.596	B	M	4	16	182B6.000	(-)COP	81364
	76	09/00 → 06/10	1.596	B	M	4	16	182B6.000	(+)COP	81341
1.6 100 16V	76	04/99 → 06/10	1.581	B	M	4	16	182A4.000	(-)COP	81364
	76	04/99 → 06/10	1.581	B	M	4	16	182A4.000	(+)COP	81341
1.6 16V	70	04/02 → 06/10	1.596	B	M	4	16	182B6.000	(-)COP	81364
	70	04/02 → 06/10	1.596	B	M	4	16	182B6.000	(+)COP	81341
1.6 16V Bipower	76	04/99 → 06/10	1.581		M	4	16	186A4.000	(-)COP	81364
	76	04/99 → 06/10	1.581		M	4	16	186A4.000	(+)COP	81341
	76	10/01 → 06/10	1.596		M	4	16	182B6.000	(-)COP	81364
	76	10/01 → 06/10	1.596		M	4	16	182B6.000	(+)COP	81341
1.6 16V Blupower	70	04/99 → 06/10	1.581	G	M	4	16	186A3.000	(-)COP	81364
	70	04/99 → 06/10	1.581	G	M	4	16	186A3.000	(+)COP	81341
1.9 JTD	88	04/02 → 06/10	1.910	D	M	4	8	186A9.000		81352
1.9 JTD 105	77	04/99 → 06/10	1.910	D	M	4	8	182B4.000		81352
1.9 JTD 110	81	03/01 → 07/02	1.910	D	M	4	8	186A6.000		81352
1.9 JTD 115	85	07/02 → 06/10	1.910	D	M	4	8	186A8.000		81352

**Palio I, Weekend**

1.2	44	07/97 → 08/02	1.242	B	M	4	8	178B7.045, 178C4.066, 188A4.000	MAGMA	81370
	50	06/99 → 10/00	1.242	B	M	4	8	178E2.000	→ M: 9.042.882	81801
	50	06/99 → 10/00	1.242	B	M	4	8	178E2.000	M →: 9.042.883, MAGMA	81370
	50	06/99 → 10/02	1.242	B	M	4	8	178E2.000	MAGMA	81370
	52	06/04 →	1.242	B	M	4	8	178E9.011	MAGMA	81370
	54	06/98 →	1.242	B	M	4	8	176A8.000, 178B5.000, 178E2.000	→ M: 9.042.882	81801
	54	06/98 →	1.242	B	M	4	8	176A8.000, 178B5.000, 178E2.000	M →: 9.042.883, MAGMA	81370
	59	09/01 →	1.242	B	M	4	16	188A5.000	PIERBURG	81369
	44	02/01 →	1.242	B	M	4	8	178C4.066, 188A4.000	M →: 9.042.883, MAGMA	81370
	54	04/96 → 02/01	1.242	B	M	4	8	178B5.000	→ M: 9.042.882	81801
	54	04/96 → 02/01	1.242	B	M	4	8	178B5.000	M →: 9.042.883, MAGMA	81370
1.2 Flex	44	07/97 → 08/02	1.242		M	4	8	188A4.000	MAGMA	81370
1.2 LPG	44	07/97 → 08/02	1.242		M	4	8	188A4.000	MAGMA	81370
1.4	51	04/96 →	1.372	B	M	4	8	178B2.000	(-)COP, (-)SS	81366
	51	04/96 →	1.372	B	M	4	8	178B2.000	(-)COP, (+)AC	81339
	51	04/96 →	1.372	B	M	4	8	178B2.000	(+)COP, (-)SS	81343
	51	04/96 →	1.372	B	M	4	8	178B2.000	(+)COP, (+)AC	81303

**KW**

**cm<sup>3</sup>**

**NO. OF VALVES**

**MAGNETI MARELLI**
**FIAT**
**Palio I, Weekend**

1.4 Cat.	51	04/96 →	1.372	B	M	4	8	178B2.016	(-)COP, (-)SS	81366
	51	04/96 →	1.372	B	M	4	8	178B2.016	(-)COP, (+)AC	81339
	51	04/96 →	1.372	B	M	4	8	178B2.016	(+)COP, (-)SS	81343
	51	04/96 →	1.372	B	M	4	8	178B2.016	(+)COP, (+)AC	81303
1.5	62	02/02 →	1.461	B	M	4	8	178E5.022	(-)COP	81364
	62	02/02 →	1.461	B	M	4	8	178E5.022	(+)COP	81341
1.6	68	07/97 → 10/03	1.581	B	M	4	16	178C7.098, 178D2.011	(-)COP	81364
	68	07/97 → 10/03	1.581	B	M	4	16	178C7.098, 178D2.011	(+)COP	81341
1.6 16V	74	04/96 →	1.581	B	M	4	16	178B3.000	(-)COP	81364
	74	04/96 →	1.581	B	M	4	16	178B3.000	(+)COP	81341
	74	04/96 → 02/01	1.581	B	M	4	16	178B3.000	(-)COP, 07-1997 →	81364
	74	04/96 → 02/01	1.581	B	M	4	16	178B3.000	(+)COP, 07-1997 →	81341
	76	02/01 →	1.596	B	M	4	16	182B6.000	(-)COP	81364
	76	02/01 →	1.596	B	M	4	16	182B6.000	(+)COP	81341
1.7 TD	51	04/96 → 03/01	1.698	D	M	4	8	176A3.000	(-)COP, → 09-1999, → M: 2.427.906	81365
	51	04/96 → 03/01	1.698	D	M	4	8	176A3.000	(+)COP, → 09-1999, → M: 2.427.906	81304
	51	04/96 → 03/01	1.698	D	M	4	8	176A3.000	10-1999 →, M →: 2.427.907	82086
1.9 D	46	03/01 →	1.910	D	M	4	8	223A6.000		81352
1.9 JTD	59	09/01 →	1.910	D	M	4	8	188A2.000		81352
<b>Panda I, Van</b>										
1.1	37	05/91 → 03/95	1.108	B	M	4	8	156C.046		81801
	40	09/00 → 02/04	1.108	B	M	4	8	187A1.000	→ M: 2.533.528, MAGMA	81370
	40	09/00 → 02/04	1.108	B	M	4	8	187A1.000	M →: 2.533.529, PIERBURG	81369
1000	32	01/86 → 04/92	999	B	M	4	8	156A2.100		81801
	32	01/86 → 02/92	999	B	M	4	8	156A2.100, 156A3.100		81801
	37	01/85 → 12/92	999	B	M	4	8	156A3.000		81801
1000 4x4	33	05/86 → 12/94	999	B	M	4	8	141C2.000, 156A2.246		81801
	37	01/86 → 12/92	999	B	M	4	8	156A3.000		81801
1000 i.e	33	08/92 → 02/04	999	B	M	4	8	156A2.246		81801
1000 i.e. Cat.	33	10/87 → 08/98	999	B	M	4	8	141C2.000, 156A2.246		81801
1100	37	05/91 → 12/99	1.108	B	M	4	8	156C.046		81801
	40	02/95 → 09/03	1.108	B	M	4	8	176B2.000, 187A1.000		81801
1100 4x4	40	02/95 → 07/04	1.108	B	M	4	8	176B2.000		81801
1100 Trekking 4x4	37	10/91 → 07/04	1.108	B	M	4	8	156C.046		81801
1300 D	27	04/86 → 12/92	1.302	D	M	4	8	156A5.000		81434
650	22	01/82 → 07/04	652	B	M	2	4	141A.000		81415

**KW**

**cm<sup>3</sup>**

**NO. OF VALVES**

**FIAT**
**Panda I, Van**

750	25	01/86 → 07/92	764	B	M	4	8	141B.000		81458
	25	01/86 → 01/95	770	B	M	4	8	141B.000		81458
	25	01/86 → 10/03	770	B	M	4	8	141B.000, 156A4.000, 156A4.048		81801
900	29	04/92 → 12/96	899	B	M	4	8	1170A1.046		81300
	33	10/80 → 06/94	903	B	M	4	8	100GL3.000, 146A.000	→ 12-1991	81415
	33	10/80 → 06/94	903	B	M	4	8	100GL3.000, 146A.000	01-1992 →	81300

**Panda II, Van**

1.1	40	09/03 →	1.108	B	M	4	8	187A1.000	→ M: 2.533.528, MAGMA	81370
	40	09/03 →	1.108	B	M	4	8	187A1.000	M →: 2.533.529, PIERBURG	81369
	40	09/04 →	1.108	B	M	4	8	187A1.000	MAGMA	81370
	40	09/04 →	1.108	B	M	4	8	187A1.000	PIERBURG	81369
1.2	44	09/03 →	1.242	B	M	4	8	188A4.000	→ M: 2.533.528, MAGMA	81370
	44	09/03 →	1.242	B	M	4	8	188A4.000	M →: 2.533.529, PIERBURG	81369
	44	09/03 →	1.242	B	M	4	8	188A4.000	TESMA	82070
	44	09/04 →	1.242	B	M	4	8	188A4.000	→ M: 2533528, MAGMA	81370
	44	09/04 →	1.242	B	M	4	8	188A4.000	M →: 2533529, PIERBURG	81369
	51	03/10 →	1.242	B	M	4	8	169A4.000	TESMA	82070
1.2 4x4	44	09/04 →	1.242	B	M	4	8	188A4.000	→ M: 2533528, MAGMA	81370
	44	09/04 →	1.242	B	M	4	8	188A4.000	M →: 2533529, PIERBURG	81369
	44	10/04 →	1.242	B	M	4	8	188A4.000	→ M: 2.533.528, MAGMA	81370
	44	10/04 →	1.242	B	M	4	8	188A4.000	M →: 2.533.529, PIERBURG	81369
	44	10/04 →	1.242	B	M	4	8	188A4.000	TESMA	82070
	51	11/09 →	1.242	B	M	4	8	169A4.000	TESMA	82070
1.2 LPG	44	04/09 →	1.242		M	4	8	188A4.000	PIERBURG	81369
	44	04/09 →	1.242		M	4	8	188A4.000	TESMA	82070
	51	11/10 →	1.242		M	4	8	169A4.000	TESMA	82070
1.2 Natural Power	44	01/07 → 11/09	1.242		M	4	8	188A4.000	PIERBURG	81369
	44	01/07 → 11/09	1.242		M	4	8	188A4.000	TESMA	82070
1.3 D Multijet	51	09/03 →	1.248	D	M	4	16	188A8.000, 188A9.000		81862
	55	01/06 →	1.248	D	M	4	16	169A1.000		81862
	55	06/06 →	1.248	D	M	4	16	169A1.000, 169A5.000		81862

	<b>KW</b>		<b>cm<sup>3</sup></b>				<b>NO. OF VALVES</b>		
--	-----------	--	-----------------------	--	--	--	----------------------	--	--

## FIAT

### Panda II, Van

1.3 D Multijet 4x4	51	10/04 →	1.248	D	M	4	16	188A8.000, 188A9.000		81862
	55	01/06 →	1.248	D	M	4	16	169A1.000		81862
	55	09/10 →	1.248	D	M	4	16	169A1.000, 169A5.000		81862
1.4	74	10/06 →	1.368	B	M	4	16	169A3.000	PIERBURG	81369
	74	10/06 →	1.368	B	M	4	16	169A3.000	TESMA	82070
1.4 Natural Power	51	01/10 →	1.368		M	4	8	350A1.000	TESMA	82070
	57	09/10 →	1.368		M	4	8	350A1.000	TESMA	82070

### Panda III, Van

0.9	57	02/12 →	875	B	M	2	8	312A2.000, 312A7.000		84008
	59	12/13 →	875	B	M	2	8	312A5.000		84008
	63	02/12 →	875	B	M	2	8	312A2.000		84008
	44	12/13 →	964	B	M	2	8	312A4.000, 312A6.000		84008
	48	02/12 →	964	B	M	2	8	312A4.000		84008
0.9 4x4	63	09/12 →	875	B	M	2	8	312A2.000		84008
	66	06/14 →	875	B	M	2	8	312A7.000		84008
0.9 Natural Power	59	01/15 →	875		M	2	8	312A2.000		84008
	63	07/12 →	875		M	2	8	312A2.000		84008
1.2	51	02/12 →	1.242	B	M	4	8	169A4.000	TESMA	82070
1.2 LPG	51	06/12 →	1.242		M	4	8	169A4.000	TESMA	82070
1.3 D Multijet	55	02/12 →	1.248	D	M	4	16	199A1.000, 199A9.000		81862
	70	04/15 →	1.248	D	M	4	16	199B1.000, 312B1.000, 330A1.000		81862
1.3 D Multijet 4x4	55	06/12 →	1.248	D	M	4	16	199A1.000, 199A9.000		81862
	59	06/14 →	1.248	D	M	4	16	225A2.000, 312A8.000, 312B2.000		81862
	70	04/15 →	1.248	D	M	4	16	199B1.000, 312B1.000, 330A1.000		81862
1.2	51	02/12 →	1.242	B	M	4	8	169A4.000	PIERBURG	81369
1.2 LPG	51	06/12 →	1.242		M	4	8	169A4.000	PIERBURG	81369

### Punto Evo, Van

1.2	48	10/09 → 02/12	1.242	B	M	4	8	199A4.000	TESMA	82070
	51	10/09 → 02/12	1.242	B	M	4	8	169A4.000	TESMA	82070
1.3 D Multijet	51	07/08 → 02/12	1.248	D	M	4	16	199B2.000		81862
	55	10/09 → 02/12	1.248	D	M	4	16	199A2.000, 199A9.000		81862
	62	10/09 → 02/12	1.248	D	M	4	16	199B4.000, 223A9.000		81862
	66	10/09 → 02/12	1.248	D	M	4	16	199A3.000		81862
	70	10/09 → 02/12	1.248	D	M	4	16	199B1.000		81862
1.4	55	07/09 → 02/12	1.368	B	M	4	8	199A7.000	TESMA	82070
	57	10/09 → 02/12	1.368	B	M	4	8	350A1.000	TESMA	82070
1.4 16V	77	10/09 → 02/12	1.368	B	M	4	16	955A6.000	TESMA	82070
	99	10/09 → 02/12	1.368	B	M	4	16	955A2.000	TESMA	82070
1.4 LPG	57	06/09 → 02/12	1.368		M	4	8	350A1.000	TESMA	82070
1.4 Natural Power	57	10/09 → 02/12	1.368		M	4	8	350A1.000	TESMA	82070
1.6 D Multijet	88	10/09 → 02/12	1.598	D	M	4	16	955A3.000		81872

**KW**

**cm<sup>3</sup>**

**NO. OF VALVES**

**MAGNETI MARELLI**
**FIAT**
**Punto I, Cabrio, Van**

55 1.1	40	09/93 → 09/99	1.108	B	M	4	8	176A6.000, 176B2.000		81801
60 1.2	43	04/94 → 06/00	1.242	B	M	4	8	176A7.000		81801
	44	05/95 → 06/00	1.242	B	M	4	8	176B1.000, 176B4.000		81801
75 1.2	54	10/93 → 09/99	1.242	B	M	4	8	176A8.000		81801
85 16V 1.2	63	04/97 → 06/00	1.242	B	M	4	16	176B9.000	PIERBURG	81369
90 1.6	65	04/94 → 04/97	1.581	B	M	4	8	176A9.000	(-)COP, 10-1993 →	81339
	65	04/94 → 04/97	1.581	B	M	4	8	176A9.000	(+)COP	81303
1.1	40	04/96 → 02/00	1.108	B	M	4	8	176B2.000		81801
1.2 16V	63	04/97 → 09/99	1.242	B	M	4	16	176B9.000	PIERBURG	81369
1.4 GT Turbo	96	09/96 → 09/99	1.372	B	M	4	8	176B6.000	(-)COP	81339
	96	09/96 → 09/99	1.372	B	M	4	8	176B6.000	(+)COP	81303
	98	01/94 → 09/96	1.372	B	M	4	8	176A4.000	(-)COP	81339
	98	01/94 → 09/96	1.372	B	M	4	8	176A4.000	(+)COP	81303
1.6	65	01/94 → 04/97	1.581	B	M	4	8	176A9.000	(-)COP	81339
	65	01/94 → 04/97	1.581	B	M	4	8	176A9.000	(+)COP	81303
1.7 D	42	04/96 → 02/00	1.698	D	M	4	8	176B3.000	(-)COP	81365
	42	04/96 → 02/00	1.698	D	M	4	8	176B3.000	(+)COP	81304
1.7 TD	46	09/96 → 09/99	1.698	D	M	4	8	176B7.000	(+)COP	81304
	52	04/96 → 02/00	1.698	D	M	4	8	176A5.000	(-)COP	81365
	52	04/96 → 02/00	1.698	D	M	4	8	176A5.000	(+)COP	81304
1.7 TD	46	09/96 → 09/99	1.698	D	M	4	8	176B7.000		82086
	51	01/94 → 09/99	1.698	D	M	4	8	176A3.000	(-)COP, → 08-1996	81365
	51	01/94 → 09/99	1.698	D	M	4	8	176A3.000	(+)COP, → 08-1996	81304
	51	01/94 → 09/99	1.698	D	M	4	8	176A3.000	08-1996 →	82086
	52	01/94 → 09/99	1.698	D	M	4	8	176A5.000	(-)COP, → 08-1996	81365
	52	01/94 → 09/99	1.698	D	M	4	8	176A5.000	(+)COP, → 08-1996	81304
	52	01/94 → 09/99	1.698	D	M	4	8	176A5.000	08-1996 →	82086

**Punto II, Cabrio, Van**

1.2 16V 80	59	09/99 →	1.242	B	M	4	16	188A5.000	PIERBURG	81369
1.2 60	44	02/00 → 10/09	1.242	B	M	4	8	188A4.000	MAGMA	81370
	44	09/99 →	1.242	B	M	4	8	188A4.000	MAGMA	81370
1.2 Bifuel	44	08/07 →	1.242	BF	M	4	8	188A4.000	PIERBURG	81369
	44	08/07 →	1.242	BF	M	4	8	188A4.000	TESMA	82070
1.2 Natural Power	44	09/03 →	1.242		M	4	8	188A4.000	→ M: 2533528, MAGMA	81370
	44	09/03 →	1.242		M	4	8	188A4.000	M →: 2533529, PIERBURG	81369
	44	09/03 →	1.242		M	4	8	188A4.000	M →: 2533529, TESMA	82070
1.3 D Multijet	55	02/05 → 10/09	1.248	D	M	4	16	188A9.000		81862
1.3 JTD	51	06/03 → 10/05	1.248	D	M	4	16	188A9.000		81862
1.3 JTD 16V	51	06/03 →	1.248	D	M	4	16	188A9.000		81862

	KW		cm <sup>3</sup>				NO. OF VALVES		
--	----	--	-----------------	--	--	--	---------------	--	--

## FIAT

### Punto II, Cabrio, Van

1.4	70	09/03 →	1.368	B	M	4	16	843A1.000	PIERBURG	81369
	71	11/05 →	1.368	B	M	4	16	199A6.000	PIERBURG	81369
	71	11/05 →	1.368	B	M	4	16	199A6.000	TESMA	82070
1.8 130 HGT	96	09/99 →	1.747	B	M	4	16	183A1.000, 188A6.000	→ 08-2000, M: 183 A1.000	81331
	96	09/99 →	1.747	B	M	4	16	183A1.000, 188A6.000	09-2000 →, M: 188 A6.000	81348
1.9 D 60	44	02/00 → 10/09	1.910	D	M	4	8	188A3.000		81352
1.9 DS 60	44	09/99 →	1.910	D	M	4	8	188A3.000		81352
1.9 JTD	63	10/01 →	1.910	D	M	4	8	188A7.000		81352
	74	06/03 →	1.910	D	M	4	8	188B2.000		81352
1.9 JTD 80	59	09/99 →	1.910	D	M	4	8	188A2.000		81352

### Punto III, Van

0.9	74	12/13 →	875	B	M	2	8	199B6.000		84008
	77	07/13 →	875	B	M	2	8	199B6.000		84008
0.9 Bifuel	63	03/12 →	875	BF	M	2	8	312A2.000		84008
0.9 Twinair Turbo	63	03/12 →	875	B	M	2	8	312A2.000		84008
1.2	49	02/14 →	1.242	B	M	4	8	199B9.000	PIERBURG	81369
	49	02/14 →	1.242	B	M	4	8	199B9.000	TESMA	82070
	51	03/12 →	1.242	B	M	4	8	169A4.000	TESMA	82070
1.3 D Multijet	55	03/12 →	1.248	D	M	4	16	199A2.000, 199A9.000		81862
	59	12/13 →	1.248	D	M	4	16	199B8.000		81862
	62	03/12 →	1.248	D	M	4	16	199B4.000		81862
	66	01/10 → 02/12	1.248	D	M	4	16	199A3.000		81862
	70	03/12 →	1.248	D	M	4	16	199B1.000		81862
1.4	55	03/12 →	1.368	B	M	4	8	199A7.000	TESMA	82070
	57	03/12 →	1.368	B	M	4	8	350A1.000	TESMA	82070
1.4 Bifuel	57	03/12 →	1.368	BF	M	4	8	350A1.000	TESMA	82070
1.4 LPG	57	03/09 →	1.368		M	4	8	350A1.000	TESMA	82070
1.4 Multi Air	77	03/12 →	1.368	B	M	4	16	955A6.000	TESMA	82070
1.4 Natural Power	57	03/12 →	1.368		M	4	8	350A1.000	TESMA	82070
1.4 Turbo Multi Air	99	03/12 →	1.368	B	M	4	16	955A2.000	TESMA	82070

### Qubo

1.3 D Multijet	55	02/08 →	1.248	D	M	4	16	199A2.000, 199A9.000		81862
	70	07/10 →	1.248	D	M	4	16	199B1.000		81862
1.4	54	02/08 →	1.360	B	M	4	8	KFT, KfV		81797
1.4 Natural Power	57	10/09 →	1.368		M	4	8	350A1.000	PIERBURG	81369
	57	10/09 →	1.368		M	4	8	350A1.000	TESMA	82070

### Regata, Weekend

100 Super 1.6	74	10/83 → 12/90	1.585	B	M	4	8	149A2.000, 149A4.000		81436
---------------	----	---------------	-------	---	---	---	---	----------------------	--	-------

**KW**

**cm<sup>3</sup>**

**NO. OF VALVES**

**MAGNETI MARELLI**
**FIAT**
**Scudo I**

1.6	58	02/96 → 12/06	1.581	B	M	4	8	220A2.000	(-)COP	81368
	58	02/96 → 12/06	1.581	B	M	4	8	220A2.000	(+)COP	81346
1.9 D	51	04/98 → 12/06	1.868	D	M	4	8	WJY (DW8B), WJZ (DW8)		81642
	51	04/98 → 12/06	1.868	D	M	4	8	WJZ (DW8)		81642
	51	02/96 → 04/98	1.905	D	M	4	8	D9B		81642
1.9 TD	66	02/96 → 12/06	1.905	D	M	4	8	DHX (XUD9TF/L)		81642
	68	02/96 → 12/06	1.905	D	M	4	8	D8B		81642
1.9 TD Eco	66	02/96 → 12/06	1.905	D	M	4	8	DHX (XUD9TF/L)		81642
2.0	100	05/00 → 12/06	1.997	B	M	4	16	RFN (EW10J4)	(-)COP	84038 <b>NEW</b>
	100	05/00 → 12/06	1.997	B	M	4	16	RFN (EW10J4)	(+)COP	82089
	100	05/00 → 12/06	1.997	B	M	4	16	RFN (EW10J4)		82089
	100	05/00 → 12/06	1.997	B	M	4	16	RFN (EW10J4)		81799
2.0 16V	100	06/00 → 12/06	1.997	B	M	4	16	RFN (EW10J4)	(-)COP	84038 <b>NEW</b>
	100	06/00 → 12/06	1.997	B	M	4	16	RFN (EW10J4)	(+)COP	82089
	100	06/00 → 12/06	1.997	B	M	4	16	RFN (EW10J4)		82089
	100	06/00 → 12/06	1.997	B	M	4	16	RFN (EW10J4)		81799
2.0 JTD	69	01/04 → 12/06	1.997	D	M	4	8	RHX		81713
	80	12/99 → 12/06	1.997	D	M	4	8	RHZ		81713
2.0 JTD 16V	80	05/99 → 12/06	1.997	D	M	4	16	RHW (DW10ATED4)		81713

**Scudo II**

1.6 D Multijet	66	01/07 →	1.560	D	M	4	16	9HU		81869
2.0 D Multijet	88	01/07 →	1.997	D	M	4	16	RHK		81800
	94	04/11 →	1.997	D	M	4	16	RH02		84020 <b>NEW</b>
	100	01/07 →	1.997	D	M	4	16	DW10BTED4, RHR		81800
	100	01/07 →	1.997	D	M	4	16	RHR		81800
	120	07/10 →	1.997	D	M	4	16	RH02, RHH		84020 <b>NEW</b>
2.0 D Multijet 4x4	88	01/07 →	1.997	D	M	4	16	RHK		81800
	94	04/11 →	1.997	D	M	4	16	RH02		84020 <b>NEW</b>

**Sedici**

1.6 16V	79	06/06 →	1.586	B	M	4	16	M16A		82026
	88	06/06 →	1.586	B	M	4	16	M16A		82026
1.6 16V 4x4	79	06/06 →	1.586	B	M	4	16	M16A		82026
	88	06/06 →	1.586	B	M	4	16	M16A		82026
1.9 D Multijet	88	06/06 →	1.910	D	M	4	8	D19AA		81352
1.9 D Multijet 4x4	88	06/06 →	1.910	D	M	4	8	D19AA		81352
2.0 D Multijet	99	06/06 →	1.956	D	M	4	16	D20AA		81872
2.0 D Multijet 4x4	99	06/06 →	1.956	D	M	4	16	D20AA		81872

**Seicento, Van**

0.9	29	01/98 → 01/10	899	B	M	4	8	1170A1.046		81300
-----	----	---------------	-----	---	---	---	---	------------	--	-------



**KW**

**cm<sup>3</sup>**

**NO. OF VALVES**

**FIAT**
**Seicento, Van**

1.1	40	01/98 → 01/10	1.108	B	M	4	8	176B2.000	→ 04-1999, → M: 9.042.882	81801
	40	01/98 → 01/10	1.108	B	M	4	8	176B2.000	05-1999 →, M →: 9.042.883, MAGMA	81370
	40	01/98 → 01/10	1.108	B	M	4	8	176B2.000, 187A1.000	→ 04-1999, → M: 9.042.882	81801
	40	01/98 → 01/10	1.108	B	M	4	8	176B2.000, 187A1.000	05-1999 →, M →: 9.042.883, MAGMA	81370

**Siena I**

1.2	44	09/01 → 12/09	1.242	B	M	4	8	178C4.066, 188A4.000	MAGMA	81370
	54	09/98 → 12/09	1.242	B	M	4	8	178B5.000	→ 06-1999	81801
	54	09/98 → 12/09	1.242	B	M	4	8	178B5.000	07-1999 →, MAGMA	81370
	59	09/01 → 12/09	1.242	B	M	4	16	188A5.000	PIERBURG	81369
1.2 Flex	52	03/04 → 05/05	1.242		M	4	8	178E9.011	TESMA	82070
1.3 JTD	51	09/03 → 12/09	1.248	D	M	4	16	188A9.000		81862
1.4	57	01/07 → 12/09	1.368	B	M	4	8	178F3.011, 350A1.000	TESMA	82070
	51	04/96 → 12/09	1.372	B	M	4	8	178B2.000	(-)COP, (-)AC, (-)SS	81366
	51	04/96 → 12/09	1.372	B	M	4	8	178B2.000	(-)COP, (+)SS, (+)AC	81339
	51	04/96 → 12/09	1.372	B	M	4	8	178B2.000	(+)COP, (-)AC, (-)SS	81343
	51	04/96 → 12/09	1.372	B	M	4	8	178B2.000	(+)COP, (+)SS, (+)AC	81303
1.4 Cat.	51	04/96 → 12/09	1.372	B	M	4	8	178B2.016	(-)COP, (-)AC, (-)SS	81366
	51	04/96 → 12/09	1.372	B	M	4	8	178B2.016	(-)COP, (+)SS, (+)AC	81339
	51	04/96 → 12/09	1.372	B	M	4	8	178B2.016	(+)COP, (-)AC, (-)SS	81343
	51	04/96 → 12/09	1.372	B	M	4	8	178B2.016	(+)COP, (+)SS, (+)AC	81303
1.5 Bipower	57	09/03 → 12/05	1.498	BF	M	4	8	178A6.011	(-)COP	81364
	57	09/03 → 12/05	1.498	BF	M	4	8	178A6.011	(+)COP	81341
1.6	76	11/00 → 12/09	1.596	B	M	4	16	182B6.000	(-)COP	81364
	76	11/00 → 12/09	1.596	B	M	4	16	182B6.000	(+)COP	81341
1.6 16V	78	09/98 → 12/09	1.581	B	M	4	16	178B3.000	(-)COP	81364
	78	09/98 → 12/09	1.581	B	M	4	16	178B3.000	(+)COP	81341
1.7 TD	51	02/06 → 12/09	1.697	D	M	4	8	176A3.000		82086
1.9 D	46	11/00 →	1.910	D	M	4	8	223A6.000		81352

**Siena II**

1.3 JTD	51	11/07 →	1.248	D	M	4	16	188A9.000		81862
1.4	57	11/07 →	1.368	B	M	4	8	199A1.000	TESMA	82070

**Stilo, Station Wagon**

1.2 16V	59	02/02 → 11/06	1.242	B	M	4	16	188A5.000	PIERBURG	81369
1.4 16V	66	03/05 → 11/06	1.368	B	M	4	16	192B2.000	PIERBURG	81369
	66	03/05 → 11/06	1.368	B	M	4	16	192B2.000	TESMA	82070
	70	01/04 → 11/06	1.368	B	M	4	16	843A1.000	PIERBURG	81369
	70	01/04 → 11/06	1.368	B	M	4	16	843A1.000	TESMA	82070

**KW**

**cm<sup>3</sup>**

**NO. OF VALVES**

**FIAT**
**Stilo, Station Wagon**

1.6 16V	76	01/03 → 08/08	1.596	B	M	4	16	182B6.000	(-)COP	81364
	76	01/03 → 08/08	1.596	B	M	4	16	182B6.000	(+)COP	81341
	77	03/05 → 12/07	1.598	B	M	4	16	192B3.000		82083
	77	05/05 → 11/06	1.598	B	M	4	16	192B3.000	(-)COP	81364
	77	05/05 → 11/06	1.598	B	M	4	16	192B3.000	(+)COP	81341
	76	10/01 → 11/06	1.596	B	M	4	16	182B6.000	(-)COP	81364
	76	10/01 → 11/06	1.596	B	M	4	16	182B6.000	(+)COP	81341
1.8 16V	98	01/03 → 08/08	1.747	B	M	4	16	192A4.000		81348
	98	10/01 → 11/06	1.747	B	M	4	16	192A4.000		81348
1.9 D	66	09/04 → 08/08	1.910	D	M	4	8	192B5.000		81352
1.9 D Multijet	74	09/05 → 11/06	1.910	D	M	4	8	192A9.000		81352
	88	09/05 → 11/06	1.910	D	M	4	8	192A8.000		81352
	110	09/05 → 11/06	1.910	D	M	4	16	937A5.000		81872
1.9 JTD	59	01/03 → 08/08	1.910	D	M	4	8	192A3.000		81352
	85	01/03 → 08/08	1.910	D	M	4	8	192A1.000, 937A7.000		81352
	93	09/03 → 11/06	1.910	D	M	4	16	937A4.000		81872
	100	04/04 → 11/06	1.910	D	M	4	16	192B1.000		81872
	103	01/04 → 11/06	1.910	D	M	4	16	192A5.000		81872
	59	02/02 → 11/06	1.910	D	M	4	8	192A3.000		81352
	66	09/04 → 11/06	1.910	D	M	4	8	192B5.000		81352
	85	10/01 → 11/06	1.910	D	M	4	8	192A1.000, 937A7.000		81352
2.4 20V	125	10/01 → 11/06	2.446	B	M	5	20	192A2.000		81329

**Strada**

1.2	44	04/03 →	1.242	B	M	4	8	188A4.000	MAGMA	81370
	44	04/03 →	1.242	B	M	4	8	188A4.000	TESMA	82070
	54	06/99 →	1.242	B	M	4	8	178B5.000	TESMA	82070
	54	06/99 →	1.242	B	M	4	8	178B5.000		81801
1.3 D Multijet	62	05/06 →	1.248	D	M	4	16	223A9.000		81862
	70	10/10 →	1.248	D	M	4	16	199B1.000		81862
1.7 TD	51	06/99 →	1.698	D	M	4	8	176A3.000	(-)COP, → M: 2.427.906	81365
	51	06/99 →	1.698	D	M	4	8	176A3.000	(+)COP, → M: 2.427.906	81304
	51	06/99 →	1.698	D	M	4	8	176A3.000	M →: 2.427.907	82086
1.9 D	46	12/00 →	1.910	D	M	4	8	223A6.000		81352
1.9 JTD	59	04/03 →	1.910	D	M	4	8	188A2.000		81352

**Talento**

1.9 D	52	03/89 → 03/94	1.929	D	M	4	8	149B1.000		81489
2.0	55	03/89 → 03/94	1.971	B	M	4	8	170B		81367



KW



cm<sup>3</sup>



NO. OF VALVES



**FIAT**

**Tempra, Station Wagon**

1.4 i.e.	51	03/92 → 08/96	1.372	B	M	4	8	160A1.046, 836A4.000	(-)COP, → M: 9.336.692, (+)AC	81314
	51	03/92 → 08/96	1.372	B	M	4	8	160A1.046, 836A4.000	(-)COP, 01-1993 →, M →: 9.336.693, (+)AC	81339
	51	03/92 → 08/96	1.372	B	M	4	8	160A1.046, 836A4.000	(-)COP, M →: 9.336.693, (-)SS	81366
	51	03/92 → 08/96	1.372	B	M	4	8	160A1.046, 836A4.000	(+)COP, → M: 9.336.692, (+)AC	81476
	51	03/92 → 08/96	1.372	B	M	4	8	160A1.046, 836A4.000	(+)COP, 01-1993 →, M →: 9.336.693, (+)AC	81303
	51	03/92 → 08/96	1.372	B	M	4	8	160A1.046, 836A4.000	(+)COP, M →: 9.336.693, (-)SS	81343
	51	03/92 → 08/96	1.372	B	M	4	8	160A1.046, 836A4.000	→ 12-1992, → M: 9.336.692, (+)SS, (+)AC	81333
	51	10/92 → 08/96	1.372	B	M	4	8	160A1.046, 836A4.000	(-)COP, 01-1993 →, (+)AC	81339
	51	10/92 → 08/96	1.372	B	M	4	8	160A1.046, 836A4.000	(+)COP, 01-1993 →, (+)AC	81303
	51	10/92 → 08/96	1.372	B	M	4	8	160A1.046, 836A4.000	→ 12-1992, → M: 9.336.692	81333
	57	03/91 → 08/96	1.372	B	M	4	8	159A2.000	(-)COP, → M: 9.336.692, (+)AC	81314
	57	03/91 → 08/96	1.372	B	M	4	8	159A2.000	(-)COP, 01-1993 →, (+)AC	81339
	57	03/91 → 08/96	1.372	B	M	4	8	159A2.000	(-)COP, M →: 9.336.693, (-)SS	81366
	57	03/91 → 08/96	1.372	B	M	4	8	159A2.000	(+)COP, → M: 9.336.692, (+)AC	81476
	57	03/91 → 08/96	1.372	B	M	4	8	159A2.000	(+)COP, 01-1993 →, (+)AC	81303
	57	03/91 → 08/96	1.372	B	M	4	8	159A2.000	(+)COP, M →: 9.336.693, (-)SS	81343
57	03/91 → 08/96	1.372	B	M	4	8	159A2.000	→ 12-1992, → M: 9.336.692	81333	

**KW**

**cm<sup>3</sup>**

**NO. OF VALVES**

**FIAT**
**Tempra, Station Wagon**

1.6	51	04/90 → 06/93	1.581	B	M	4	8	159A3.048	(-)COP, (+)AC	81314
	51	04/90 → 06/93	1.581	B	M	4	8	159A3.048	(+)COP, (+)AC	81476
	51	04/90 → 06/93	1.581	B	M	4	8	159A3.048	(+)SS, (+)AC	81333
	63	12/90 → 04/93	1.581	B	M	4	8	159A3.000	(-)COP, (+)AC	81314
	63	12/90 → 04/93	1.581	B	M	4	8	159A3.000	(+)COP, (+)AC	81476
	63	12/90 → 04/93	1.581	B	M	4	8	159A3.000	(+)SS, (+)AC	81333
	63	03/90 → 04/93	1.581	B	M	4	8	159A3.000, 159B9.000	(-)COP, (+)AC	81314
	63	03/90 → 04/93	1.581	B	M	4	8	159A3.000, 159B9.000	(+)COP, (+)AC	81476
	63	03/90 → 04/93	1.581	B	M	4	8	159A3.000, 159B9.000	(+)SS, (+)AC	81333
1.6 i.e.	55	06/92 → 08/96	1.581	B	M	4	8	159A3.048, 835C1.000	(-)COP, (+)AC	81339
	55	06/92 → 08/96	1.581	B	M	4	8	159A3.048, 835C1.000	(+)COP, (+)AC	81303
	57	06/90 → 07/92	1.581	B	M	4	8	159A3.046	(-)COP, (+)AC	81314
	57	06/90 → 07/92	1.581	B	M	4	8	159A3.046	(+)COP, (+)AC	81476
	57	06/90 → 07/92	1.581	B	M	4	8	159A3.046	(+)SS, (+)AC	81333
	57	10/90 → 08/96	1.581	B	M	4	8	159A3.046, 835C1.000	(-)COP, → 12-1992, (+)AC	81314
	57	10/90 → 08/96	1.581	B	M	4	8	159A3.046, 835C1.000	(-)COP, 01-1993 →, (+)AC	81339
	57	10/90 → 08/96	1.581	B	M	4	8	159A3.046, 835C1.000	(+)COP, → 12-1992, (+)AC	81476
	57	10/90 → 08/96	1.581	B	M	4	8	159A3.046, 835C1.000	(+)COP, 01-1993 →, (+)AC	81303
	57	10/90 → 08/96	1.581	B	M	4	8	159A3.046, 835C1.000	→ 12-1992, (+)AC, (+)SS, (+)AC	81333
	63	06/94 → 08/96	1.581	B	M	4	8	159B9.000	(-)COP, (+)AC	81339
	63	06/94 → 08/96	1.581	B	M	4	8	159B9.000	(+)COP, (+)AC	81303
1.8 i.e.	66	06/94 → 08/96	1.581	B	M	4	8	159B9.000	(-)COP, (+)AC	81339
	66	06/94 → 08/96	1.581	B	M	4	8	159B9.000	(+)COP, (+)AC	81303
	66	09/93 → 08/96	1.756	B	M	4	8	835C4.000		81315
	74	10/94 → 08/96	1.756	B	M	4	8	836A5.000	01-1992 →, → 07-1996	81315
	74	10/94 → 08/96	1.756	B	M	4	8	836A5.000		81315
	76	09/93 → 08/96	1.756	B	M	4	8	835C2.000	01-1992 →, → 07-1996	81315
	76	09/93 → 08/96	1.756	B	M	4	8	835C2.000		81315
	77	03/92 → 08/96	1.756	B	M	4	8	159A4.046	01-1992 →, → 07-1996	81315
	77	03/92 → 12/93	1.756	B	M	4	8	159A4.046		81315
	81	03/90 → 08/96	1.756	B	M	4	8	159A4.000	→ 06-1992	81477
1.9 D	81	03/90 → 08/96	1.756	B	M	4	8	159A4.000	07-1992 →	81315
	48	07/91 → 08/96	1.929	D	M	4	8	149A1.000, 160A7.000	(-)COP	81363
	48	07/91 → 08/96	1.929	D	M	4	8	149A1.000, 160A7.000	(+)COP	81347

		KW		cm <sup>3</sup>				NO. OF VALVES		
--	--	----	--	-----------------	--	--	--	---------------	--	--

**FIAT**
**Tempra, Station Wagon**

1.9 TD	66	05/90 → 08/96	1.929	D	M	4	8	160A6.000, 160D1.000	(-)COP, → M: 1.071.902, (+)AC	81326
	66	05/90 → 08/96	1.929	D	M	4	8	160A6.000, 160D1.000	(+)COP, → M: 1.071.902, (+)AC	81464
2.0 i.e.	83	10/90 → 08/96	1.995	B	M	4	8	159A6.046	→ 12-1991	81460
	83	10/90 → 08/96	1.995	B	M	4	8	159A6.046	01-1992 →	81315
2.0 i.e. 4x4	83	03/92 → 03/95	1.995	B	M	4	8	159A6.046		81315

**Tipo I**

1.1	41	01/88 → 10/91	1.108	B	M	4	8	160A3.000		81801
1.4 i.e.	57	05/89 → 04/95	1.372	B	M	4	8	159A2.000	(-)COP, (+)AC	81314
	57	05/89 → 04/95	1.372	B	M	4	8	159A2.000	(+)AC, (+)SS	81333
	57	05/89 → 04/95	1.372	B	M	4	8	159A2.000	(+)COP, (+)AC	81476
	51	05/89 → 04/95	1.372	B	M	4	8	160A1.046, 836A4.000	(-)COP, (+)AC	81314
	51	05/89 → 04/95	1.372	B	M	4	8	160A1.046, 836A4.000	(+)AC, (+)SS	81333
	51	05/89 → 04/95	1.372	B	M	4	8	160A1.046, 836A4.000	(+)COP, (+)AC	81476
1.6	61	01/88 → 10/91	1.581	B	M	4	8	160A2.000	(-)COP, (+)AC	81314
	61	01/88 → 10/91	1.581	B	M	4	8	160A2.000	(+)AC, (+)SS	81333
	61	01/88 → 10/91	1.581	B	M	4	8	160A2.000	(+)COP, (+)AC	81476
1.6 i.e.	66	02/88 → 05/91	1.595	B	M	4	8	149C2.046		81477
	55	10/92 → 04/95	1.581	B	M	4	8	159A3.048, 835C1.000	(-)COP, (+)AC	81314
	55	10/92 → 04/95	1.581	B	M	4	8	159A3.048, 835C1.000	(+)AC, (+)SS	81333
	55	10/92 → 04/95	1.581	B	M	4	8	159A3.048, 835C1.000	(+)COP, (+)AC	81476
	57	07/90 → 01/93	1.581	B	M	4	8	159A3.046	(-)COP, (+)AC	81314
	57	07/90 → 01/93	1.581	B	M	4	8	159A3.046	(+)AC, (+)SS	81333
	57	07/90 → 01/93	1.581	B	M	4	8	159A3.046	(+)COP, (+)AC	81476
1.6 SX DGT	66	05/89 → 10/95	1.581	B	M	4	8	159A3.000		81477
1.7 D	43	01/88 → 10/94	1.697	D	M	4	8	149B4.000	(-)COP, 01-1993 →	81363
	43	01/88 → 10/94	1.697	D	M	4	8	149B4.000	(+)COP, → 12-1992	81463
	43	01/88 → 10/94	1.697	D	M	4	8	149B4.000	(+)COP, 01-1993 →	81347
	45	01/88 → 10/95	1.697	D	M	4	8	149B4.000	(-)COP, 01-1993 →	81363
	45	01/88 → 10/95	1.697	D	M	4	8	149B4.000	(+)COP, → 12-1992	81463
	45	01/88 → 10/95	1.697	D	M	4	8	149B4.000	(+)COP, 01-1993 →	81347
1.8 i.e.	71	03/93 → 04/95	1.756	B	M	4	8	836A5.000		81315
	66	09/93 → 04/95	1.756	B	M	4	8	835C4.000		81315
	81	10/90 → 06/93	1.756	B	M	4	8	159A4.000		81315
	74	10/94 → 10/95	1.756	B	M	4	8	159A4.000, 836A5.000		81315
	76	04/93 → 04/95	1.756	B	M	4	8	835C2.000		81315
	77	10/90 → 06/93	1.756	B	M	4	8	159A4.046		81315
1.8 i.e. 16V Sport	100	11/89 → 06/92	1.756	B	M	4	16	160A5.000		81477
1.9 D	48	07/91 → 08/95	1.929	D	M	4	8	149A1.000, 160A7.000	(-)COP, 01-1993 →	81363
	48	07/91 → 08/95	1.929	D	M	4	8	149A1.000, 160A7.000	(+)COP, → 12-1992	81463
	48	07/91 → 08/95	1.929	D	M	4	8	149A1.000, 160A7.000	(+)COP, 01-1993 →	81347

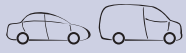
**KW**

**cm<sup>3</sup>**

**NO. OF VALVES**

**MAGNETI MARELLI**
**FIAT**
**Tipo I**

1.9 TD	59	03/92 → 06/93	1.929	D	M	4	8	160B6.046	(-)COP, → 12-1992, (+)SS, (+)AC	81326
	59	03/92 → 06/93	1.929	D	M	4	8	160B6.046	(+)COP, → 12-1992, (+)SS, (+)AC	81464
	66	09/90 → 04/95	1.929	D	M	4	8	160A6.000, 160A6.046, 160D1.000	(-)COP, → 12-1992, (+)AC, (+)SS, (+)AC	81326
	66	09/90 → 04/95	1.929	D	M	4	8	160A6.000, 160A6.046, 160D1.000	(+)COP, → 12-1992, (+)AC, (+)SS, (+)AC	81464
2.0 16V	107	07/91 → 04/95	1.995	B	M	4	16	160A8.046		81315
2.0 i.e.	80	06/90 → 03/92	1.995	B	M	4	8	159A5.046	→ 06-1991	81460
	80	06/90 → 03/92	1.995	B	M	4	8	159A5.046	07-1991 →	81315
	83	03/90 → 04/95	1.995	B	M	4	8	159A6.046	→ 06-1991	81460
	83	03/90 → 04/95	1.995	B	M	4	8	159A6.046	07-1991 →	81315
2.0 i.e. 16V Sport	102	03/93 → 04/95	1.995	B	M	4	16	836A3.000		81322

**Tipo II**

1.3 D Multijet	70	10/15 →	1.248	D	M	4	16	199B1.000, 55266963		81862
1.4	70	10/15 →	1.368	B	M	4	16	843A1.000	TESMA	82070

**Ulysse I**

1.8	73	05/97 → 08/02	1.761	B	M	4	8	LFW		81512
1.9 TD	66	02/95 → 08/02	1.905	D	M	4	8	DHX (XUD9TF/L)	→ 04-1995	81672
	66	02/95 → 08/02	1.905	D	M	4	8	DHX (XUD9TF/L)	05-1995 →	81642
2.0	89	06/94 → 08/02	1.998	B	M	4	8	RFU (XU10J2C)		81642
2.0 16V	100	09/00 → 08/02	1.997	B	M	4	16	RFN (EW10J4)		81711
	97	05/98 → 09/00	1.998	B	M	4	16	RFV		81711
2.0 JTD	80	10/99 → 08/02	1.997	D	M	4	8	RHZ		81713
2.0 JTD 16V	80	05/99 → 08/02	1.997	D	M	4	16	RHW (DW10ATED4)		81713
2.0 Turbo	108	06/94 → 08/02	1.998	B	M	4	8	RGX (XU10J2CTE)		81642
2.1 TD	80	03/96 → 10/99	2.088	D	M	4	12	P8C	04-1996 →	81353

**Ulysse II**

2.0	100	08/02 → 06/11	1.997	B	M	4	16	RFN (EW10J4)	(-)COP	84038	<b>NEW</b>
	100	08/02 → 06/11	1.997	B	M	4	16	RFN (EW10J4)	(+)COP	82089	
	100	08/02 → 06/11	1.997	B	M	4	16	RFN (EW10J4)		82089	
	100	08/02 → 06/11	1.997	B	M	4	16	RFN (EW10J4)		81799	
2.0 D Multijet	88	05/06 → 06/11	1.997	D	M	4	16	RHK		81800	
	100	05/06 → 06/11	1.997	D	M	4	16	RHR		81800	
2.0 JTD	79	05/03 → 08/06	1.997	D	M	4	16	RHM (DW10ATED4)		81713	
	80	08/02 → 08/06	1.997	D	M	4	16	RHW (DW10ATED4)		81713	
2.2 D Multijet	125	03/08 → 06/11	2.179	D	M	4	16	4HS, 4HT (DW12BTED4)		82068	
2.2 JTD	94	08/02 → 08/06	2.179	D	M	4	16	4HW (DW12ATED4)		81800	
	120	03/08 → 06/11	2.179	D	M	4	16	4HP, 4HR		82068	
3.0	150	08/02 → 06/11	2.946	B	M	6	24	XFW		81813	

		KW		cm <sup>3</sup>				NO. OF VALVES			
--	--	----	--	-----------------	--	--	--	---------------	--	--	--

## FIAT

### Uno I

1.0	31	06/89 → 02/92	999	B	M	4	8	156A2.000		81801
1.0 iE	34	05/98 → 08/00	999	B	M	4	8	156A2.246		81801
1.1	41	01/92 → 06/06	1.108	B	M	4	8	160A3.000	MAGMA	81370
	43	10/88 → 06/06	1.108	B	M	4	8	146A4.048, 160A3.000	MAGMA	81370
1.3 Super Diesel	33	06/83 → 03/92	1.302	D	M	4	8	127A5.000, 146B1.000		81434
1.4	51	07/91 → 07/96	1.372	B	M	4	8	160A1.046	(-)COP	81366
	51	07/91 → 07/96	1.372	B	M	4	8	160A1.046	(+)COP	81343
	74	01/89 → 12/91	1.372	B	M	4	8	146A8.000	(-)COP	81366
	74	01/89 → 12/91	1.372	B	M	4	8	146A8.000	(+)COP	81343
1.4 Turbo i.e.	82	09/89 → 09/93	1.372	B	M	4	8	146A8.046	(-)COP	81481
	87	12/89 → 12/96	1.372	B	M	4	8	146A8.000	(-)COP	81481
1.7 D	43	11/94 → 08/00	1.697	D	M	4	8	146B2.000	(+)COP	81469
1.9 D	44	09/89 → 03/94	1.929	D	M	4	8	149B5.046	(+)COP	81469
	58	01/89 → 12/91	1.929	D	M	4	8		(+)COP	81469
45 0.9	33	03/83 → 09/92	903	B	M	4	8	146A.000, 146A1.000		81415
45 1.0	32	06/86 → 12/93	999	B	M	4	8	156A2.048, 156A2.100		81801
45 i.e. 1.0	33	04/84 → 10/95	999	B	M	4	8	156A2.246		81801
50 1.1	37	01/90 → 12/93	1.108	B	M	4	8	156C.046	01-1989 →, → 12-1991	81801
50 i.e. 1.1	36	06/92 → 12/93	1.116	B	M	4	8	146C3.000		81801
55 1.0	41	11/93 → 08/00	996	B	M	4	8	146C4.011		81434
60 1.1	42	04/89 → 12/92	1.108	B	M	4	8	160A3.000		81801
60 Diesel 1.7	42	09/89 → 12/93	1.698	D	M	4	8	146B2.000	(+)COP	81469
70 i.e. 1.4	51	09/89 → 12/93	1.372	B	M	4	8	160A1.046	(-)COP, (-)AC	81481
	51	09/89 → 12/93	1.372	B	M	4	8	160A1.046	(-)COP, (+)AC	81314
	51	09/89 → 12/93	1.372	B	M	4	8	160A1.046	(+)COP, (+)AC	81476
	51	09/89 → 12/93	1.372	B	M	4	8	160A1.046	(+)SS, (+)AC	81333
	53	09/89 → 12/93	1.372	B	M	4	8	146C1.000	(-)COP, (-)AC	81481
	53	09/89 → 12/93	1.372	B	M	4	8	146C1.000	(-)COP, (+)AC	81314
	53	09/89 → 12/93	1.372	B	M	4	8	146C1.000	(+)COP, (+)AC	81476
	53	09/89 → 12/93	1.372	B	M	4	8	146C1.000	(+)SS, (+)AC	81333
70 TD 1.4	52	10/86 → 10/90	1.367	D	M	4	8	146B.000, 146B3.000	(+)COP, → 12-1989, M: 146B.000	81450

## FORD

### B-Max, Van

1.0 EcoBoost	74	10/12 →	998	B	M	3	12	SFJA, SFJB, SFJC, SFJD		84036	
	88	10/12 →	998	B	M	3	12	M1JA		84036	
	92	10/12 →	998	B	M	3	12	M1JE		84036	
1.4	66	10/12 →	1.388	B	M	4	16	SPJD		82027	
1.4 LPG	63	08/13 →	1.388		M	4	16	RTJC		82027	
	66	08/13 →	1.388		M	4	16	RTJC		82027	

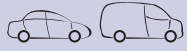
**KW**

**cm<sup>3</sup>**

**NO. OF VALVES**

**FORD**
**B-Max, Van**

1.5 TDCi	55	10/12 →	1.499	D	M	4	8	UGJC		81798
	55	10/12 →	1.499	D	M	4	8	UGJC		81869
1.6 TDCi	70	10/12 →	1.560	D	M	4	8	T3JB		81798
	70	10/12 →	1.560	D	M	4	8	T3JB		81869
1.6 Ti	77	10/12 →	1.596	B	M	4	16	IQJA		82027

**C-Max I**

1.6	74	02/07 → 09/10	1.596	B	M	4	16	HWDA, HWDB, SHDA, SHDB, SHDC		82027
	85	04/07 → 09/10	1.596	B	M	4	16	HXDA, HXDB, SIDA		82027
1.6 TDCi	66	02/07 → 09/10	1.560	D	M	4	16	GPDA, HHDA, HHDB		81869
	74	02/07 → 09/10	1.560	D	M	4	16	G8DC, MTDA		81798
	74	02/07 → 09/10	1.560	D	M	4	16	G8DC, MTDA		81869
1.8	90	02/07 → 09/10	1.798	B	M	4	16	QQDC		81804
	92	02/07 → 09/10	1.798	B	M	4	16	QQDA, QQDB		81804
1.8 Flexifuel	92	02/07 → 09/10	1.798		M	4	16	Q7DA		81804
1.8 TDCi	85	02/07 → 09/10	1.753	D	M	4	8	KKDA		81802
2.0	107	02/07 → 09/10	1.999	B	M	4	16	AODA, AODB, AODE, SYDA		81804
2.0 CNG	107	04/09 → 09/10	1.999		M	4	16	SYDA		81804
2.0 LPG	107	06/08 → 09/10	1.999		M	4	16	SYDA		81804
2.0 TDCi	81	02/08 → 09/10	1.997	D	M	4	16	IXDA		81800
	98	02/07 → 09/10	1.997	D	M	4	16	G6DC, G6DE, G6DF		81800
	100	02/07 → 09/10	1.997	D	M	4	16	G6DA, G6DB, G6DD, G6DG		81800

**C-Max II, Van**

1.0 EcoBoost	74	10/12 →	998	B	M	3	12	M2DA, SFDA		84036	<b>NEW</b>
	92	10/12 →	998	B	M	3	12	M1DA		84036	<b>NEW</b>
1.6 CNG	86	01/13 →	1.596		M	4	16	MUDA		82027	
1.6 EcoBoost	110	12/10 →	1.596	B	M	4	16	JQDA, JQDB		82027	
	134	12/10 →	1.596	B	M	4	16	JTDA, JTDB		82027	
1.6 Flexifuel	88	02/11 →	1.596		M	4	16	MUDA		82027	
1.6 LPG	86	02/12 →	1.596		M	4	16	MUDA		82027	
	88	02/12 →	1.596		M	4	16	MUDA		82027	
1.6 TDCi	85	12/10 →	1.560	D	M	4	8	T1DA, T1DB		81869	
1.6 Ti	63	12/10 →	1.596	B	M	4	16	XTDA		82027	
	77	12/10 →	1.596	B	M	4	16	IQDA, IQDB		82027	
	92	12/10 →	1.596	B	M	4	16	PNDA		82027	
2.0 TDCi	85	02/11 →	1.997	D	M	4	16	TYDA		84020	<b>NEW</b>
	100	02/11 →	1.997	D	M	4	16	UKDB		84020	<b>NEW</b>
	103	02/11 →	1.997	D	M	4	16	UFDB		84020	<b>NEW</b>
	110	03/15 →	1.997	D	M	4	16	T7DB		82068	
	120	12/10 →	1.997	D	M	4	16	TXDB		84020	<b>NEW</b>
125	03/15 →	1.997	D	M	4	16	T8DE		82068		



		KW		cm <sup>3</sup>				NO. OF VALVES		
--	--	----	--	-----------------	--	--	--	---------------	--	--

## FORD

### Cougar

2.0 16V	96	08/98 → 12/01	1.988	B	M	4	16	EDBA, EDBB, EDBC, EDBD		81803
2.5 ST 200	151	01/00 → 12/01	2.495	B	M	6	24	SGA		81845
2.5 V6 24V	125	06/00 → 12/01	2.495	B	M	6	24	LCBB, LCBC, LCBE		81845
	125	08/98 → 12/01	2.544	B	M	6	24	LCBA		81845

### Ecosport II

1.0 EcoBoost	92	10/13 →	998	B	M	3	12	M1JC		84036	
	103	03/16 →	998	B	M	3	12	YYJD		84036	
1.5 TDCi	66	10/13 →	1.499	D	M	4	8	UGJE		81798	
	66	10/13 →	1.499	D	M	4	8	UGJE		81869	
1.5 Ti	82	10/13 →	1.498	B	M	4	16	UEJB		82027	
1.6 Ti-VCT	90	08/12 →	1.596	B	M	4	16	HXJD, IQJB		82027	

### Escort Classic

1.6 16V	66	10/98 → 07/00	1.597	B	M	4	16	L1E		81803
1.8 TD	66	10/98 → 07/00	1.753	D	M	4	8	RFD, RFK		81657

### Escort IV, Station Wagon, Cabrio, Express

1.1	37	12/85 → 07/90	1.117	B	M	4	8	GSG	→ 12-1988	81531
	37	05/86 → 07/90	1.117	B	M	4	8	GSG		81531
1.3	44	02/86 → 07/90	1.297	B	M	4	8	JBB, JLA, JLB		81650
	46	07/88 → 07/90	1.297	B	M	4	8	JBA		81650
	46	07/88 → 10/90	1.297	B	M	4	8	JBA	02-1986 →, → 04-1991	81650
1.4	51	10/85 → 10/90	1.392	B	M	4	8	FUAA		81538
	54	01/86 → 07/90	1.392	B	M	4	8	F6B, F6D, FUC		81538
	55	01/86 → 07/90	1.392	B	M	4	8	FUA	01-1986 →	81538
	55	01/86 → 07/90	1.392	B	M	4	8	FUA		81538
1.4 i	54	02/86 → 07/90	1.392	B	M	4	8	F6B, F6D, FUC		81538
1.6	58	01/86 → 07/90	1.597	B	M	4	8	LP2		81538
	60	02/86 → 07/90	1.597	B	M	4	8	LUC		81538
	65	04/89 → 07/90	1.598	B	M	4	8	LUG	02-1982 →, → 12-1992	81538
1.6 D	40	02/86 → 07/90	1.608	D	M	4	8	LTA		81536
1.6 i	66	01/86 → 07/90	1.597	B	M	4	8	L4B		81538
	75	08/89 → 07/90	1.597	B	M	4	8	LJB	02-1982 →, → 12-1992	81538
	75	08/89 → 07/90	1.597	B	M	4	8	LJB		81538
	66	01/86 → 05/90	1.598	B	M	4	8	L4B		81538
1.6 Turbo RS	97	01/86 → 07/90	1.597	B	M	4	8	LNB	02-1982 →, → 12-1992	81538
1.6 XR3i	77	01/86 → 07/90	1.597	B	M	4	8	LR2, LRB		81538
1.8 D	44	07/88 → 07/90	1.753	D	M	4	8	RTA, RTB		81651
	44	01/89 → 07/90	1.753	D	M	4	8	RTA, RTB	01-1990 →	81651

**KW**

**cm<sup>3</sup>**

**NO. OF VALVES**

**MAGNETI MARELLI**
**FORD**
**Escort V, Station Wagon, Cabrio, Express**

1.3	44	07/90 → 09/92	1.299	B	M	4	8	J4B, J6A	→ 04-1991	81650
	44	07/90 → 09/92	1.299	B	M	4	8	J4B, J6A	05-1991 →	81653
	44	09/91 → 09/92	1.299	B	M	4	8	J4B, J6A		81653
	46	07/90 → 12/94	1.299	B	M	4	8	JBD	05-1991 →	81653
1.4	52	07/90 → 12/94	1.391	B	M	4	8	F6F, F6G		81538
	52	07/90 → 09/92	1.392	B	M	4	8	F6F, F6G		81538
1.6	66	07/90 → 08/92	1.598	B	M	4	8	LUJ, LUK		81538
	77	07/90 → 12/92	1.598	B	M	4	8	LJF		81538
1.8 16V	77	02/92 → 12/92	1.796	B	M	4	16	RDA		81655
1.8 16V XR3i	77	02/92 → 12/92	1.796	B	M	4	16	RDA		81655
	96	02/92 → 12/92	1.796	B	M	4	16	RQB		81655
1.8 D	44	07/90 → 12/92	1.753	D	M	4	8	RTE, RTF, RTH		81651
	44	07/90 → 12/94	1.753	D	M	4	8	RTH		81651
RS 2000	110	05/91 → 12/92	1.998	B	M	4	16	N7A	→ 06-1991	81654

**Escort VI, Station Wagon, Cabrio**

1.3	44	09/92 → 01/95	1.299	B	M	4	8	J4B, J6A		81653
1.4	52	09/92 → 01/95	1.391	B	M	4	8	F6F, F6G		81538
	52	12/92 → 04/94	1.392	B	M	4	8	F6F, F6G		81538
	55	01/94 → 01/95	1.392	B	M	4	8	F4B, FUH		81538
1.4 i	55	07/93 → 01/95	1.392	B	M	4	8	F4B		81538
1.6 16V XR3i	66	12/92 → 01/95	1.597	B	M	4	16	L1E		81655
1.6 i 16V	65	01/94 → 01/95	1.597	B	M	4	16	L1H		81655
	66	09/92 → 01/95	1.597	B	M	4	16	L1E		81655
	66	08/93 → 01/95	1.597	B	M	4	16	L1E, L1K		81655
1.8 16V XR3i	77	12/92 → 01/95	1.796	B	M	4	16	RDA		81655
	96	09/92 → 01/95	1.796	B	M	4	16	RQB		81655
1.8 D	44	09/92 → 01/95	1.753	D	M	4	8	RTE, RTF, RTH		81651
	44	08/93 → 01/95	1.753	D	M	4	8	RTE, RTF, RTH	01-1990 →	81651
	44	09/92 → 01/95	1.753	D	M	4	8	RTH	01-1990 →	81651
1.8 i 16V	77	09/92 → 01/95	1.796	B	M	4	16	RDA		81655
	77	01/93 → 01/95	1.796	B	M	4	16	RDA	01-1990 →	81655
	96	02/93 → 01/95	1.796	B	M	4	16	RQB		81655
1.8 TD	66	02/93 → 01/95	1.753	D	M	4	8	RFD, RFK		81657
	66	02/93 → 01/95	1.753	D	M	4	8	RFD, RFK, RFS		81657
1.8 XR3i 16V 4x4	77	08/93 → 01/95	1.796	B	M	4	16	RDA		81655
	96	08/93 → 01/95	1.796	B	M	4	16	RQB		81655

**Escort VII, Station Wagon, Cabrio, Express**

1.3	44	01/95 → 10/98	1.299	B	M	4	8	J4B, J6A		81653
1.4	54	01/95 →	1.392	B	M	4	8	F4B		81538
	55	01/95 → 10/98	1.392	B	M	4	8	F4B		81538
	55	02/95 → 08/98	1.392	B	M	4	8	F4B	01-1986 →	81538
	55	01/95 → 02/99	1.392	B	M	4	8	F4B, FUH		81538
1.6 16V	66	01/95 → 10/98	1.597	B	M	4	16	L1E		81655
1.6 16V 4x4	66	01/95 → 10/98	1.597	B	M	4	16	L1E		81655

**KW**

**cm<sup>3</sup>**

**NO. OF VALVES**

**FORD**
**Escort VII, Station Wagon, Cabrio, Express**

1.6 16V XR3i	65	02/95 → 12/96	1.597	B	M	4	16	L1H		81655
	66	02/95 → 09/99	1.597	B	M	4	16	L1E		81655
1.6 i 16V	65	01/95 → 08/95	1.597	B	M	4	16	L1H		81655
	66	01/95 → 02/99	1.597	B	M	4	16	L1E, L1K		81655
1.8 16V	77	01/95 → 08/95	1.796	B	M	4	16	RDA		81655
	85	01/95 → 10/98	1.796	B	M	4	16	RKC		81655
1.8 16V XR3i	77	02/95 → 08/98	1.796	B	M	4	16	RDA		81655
	85	10/95 → 08/98	1.796	B	M	4	16	RKC		81655
	96	02/95 → 08/00	1.796	B	M	4	16	RQB		81655
1.8 D	44	01/95 → 12/96	1.753	D	M	4	8	RTE, RTF, RTH		81651
	44	01/95 →	1.753	D	M	4	8	RTF, RTH		81651
1.8 TD	66	01/95 → 10/98	1.753	D	M	4	8	RFD, RFK		81657
1.8 Turbo D	51	12/95 → 06/01	1.753	D	M	4	8	RVA		81657

**Fiesta II, Van**

1.8 D	43	03/89 → 12/95	1.753	D	M	4	8	RTC, RTD, RTG		81651
-------	----	---------------	-------	---	---	---	---	---------------	--	-------

**Fiesta III, Van**

1.0	33	03/89 → 12/95	1.001	B	M	4	8	TLB	→ 04-1991	81650
	33	03/89 → 12/95	1.001	B	M	4	8	TLB	05-1991 →	81653
1.1	37	03/89 → 12/95	1.119	B	M	4	8	G6A	→ 04-1991	81650
	37	03/89 → 12/95	1.119	B	M	4	8	G6A	05-1991 →	81653
	40	03/89 → 12/95	1.119	B	M	4	8	GUD, GUE	→ 04-1991	81650
	40	03/89 → 12/95	1.119	B	M	4	8	GUD, GUE	05-1991 →	81653
1.3	44	09/91 → 02/96	1.299	B	M	4	8	J6B		81653
	44	03/89 → 12/92	1.299	B	M	4	8	JBC	→ 04-1991	81650
	44	03/89 → 12/92	1.299	B	M	4	8	JBC	05-1991 →	81653
1.3 Cat.	44	05/91 → 01/97	1.299	B	M	4	8	J6B		81653
1.4	52	03/89 → 12/95	1.391	B	M	4	8	F6E		81538
	54	03/89 → 12/95	1.391	B	M	4	8	FUG, FUJ		81538
1.4 Cat.	54	03/89 → 12/95	1.391	B	M	4	8	F4A		81538
1.6	65	01/89 → 01/94	1.597	B	M	4	8	LUH		81538
1.6 i 16V	65	01/94 → 12/95	1.597	B	M	4	16	L1G		81655
1.6 Turbo	96	03/90 → 10/92	1.598	B	M	4	8	LHA		81538
1.6 XR2i	81	03/89 → 01/94	1.597	B	M	4	8	LJC		81538
	76	03/89 → 03/93	1.598	B	M	4	8	LJD		81538
1.8 16V	77	02/92 → 12/95	1.796	B	M	4	16	RDB		81655
1.8 D	44	09/91 → 02/96	1.753	D	M	4	8	RTC, RTD, RTG		81651
1.8 TD	55	03/93 → 12/95	1.753	D	M	4	8	RFL		81657
1.8 XR2i 16V	96	02/92 → 12/95	1.796	B	M	4	16	RQC		81655

**Fiesta IV, Van**

1.25 i 16V	55	08/95 → 01/02	1.242	B	M	4	16	DHA, DHB, DHC, DHD, DHE, DHF, DHG		81598
1.3	44	02/96 →	1.299	B	M	4	8	J4C		81653

**KW**

**cm<sup>3</sup>**

**NO. OF VALVES**

**MAGNETI MARELLI**
**FORD**
**Fiesta IV, Van**

1.3 i	37	08/95 → 01/02	1.299	B	M	4	8	JJA, JJC, JJE, JJJ, JJK, JJM		81716
	44	08/95 → 01/02	1.299	B	M	4	8	J4C, J4J, J4L, J4Q, J4R, J4T, JBC		81716
1.4 i	66	04/96 → 10/99	1.388	B	M	4	16	FHA		81598
1.4 i 16V	66	04/96 → 01/02	1.388	B	M	4	16	FHA, FHE		81598
1.6 16V Sport	76	02/00 → 01/02	1.596	B	M	4	16	L1T, L1V		81598
1.8 D	44	08/95 → 04/00	1.753	D	M	4	8	RTJ, RTK		81651
	44	02/96 → 04/02	1.753	D	M	4	8	RTK	01-1989 →	81651
1.8 Di	55	09/00 → 08/03	1.753	D	M	4	8	RTN, RTP		81802
	55	04/00 → 01/02	1.753	D	M	4	8	RTN, RTP, RTQ		81802
D 1.8	44	05/98 → 04/02	1.753	D	M	4	8	RTJ, RTK		81651
TD 1.8	55	03/00 → 08/03	1.753	D	M	4	8	RTN, RTP, RTQ		81802

**Fiesta V, Van**

1.25 16V	51	03/03 → 06/08	1.242	B	M	4	16	M7JA, M7JB	→ 04-2005	81598
	51	03/03 → 06/08	1.242	B	M	4	16	M7JA, M7JB	05-2005 →	82027
	55	05/02 → 06/08	1.242	B	M	4	16	FUJA, FUJB	→ 04-2005	81598
	55	05/02 → 06/08	1.242	B	M	4	16	FUJA, FUJB	05-2005 →	82027
1.3	44	11/01 → 06/08	1.299	B	M	4	8	BAJA		82018
	51	11/01 → 06/08	1.299	B	M	4	8	A9JA, A9JB		82018
1.4 16V	59	11/01 → 06/08	1.388	B	M	4	16	FXJA, FXJB	→ 04-2005	81598
	59	11/01 → 06/08	1.388	B	M	4	16	FXJA, FXJB	05-2005 →	82027
1.4 TDCi	50	11/01 → 06/08	1.399	D	M	4	8	F6JA, F6JB		81798
1.6 16V	74	11/01 → 06/08	1.596	B	M	4	16	FYJA, FYJB	→ 04-2005	81598
	74	11/01 → 06/08	1.596	B	M	4	16	FYJA, FYJB	05-2005 →	82027
1.6 TDCi	66	11/04 → 06/08	1.560	D	M	4	16	HHJA, HHJB		81869
ST150	110	03/05 → 06/08	1.999	B	M	4	16	N4JB		81804

**Fiesta VI, Van**

1.0	48	01/13 →	998	B	M	3	12	XMJA, XMJB		84036	<b>NEW</b>
	59	10/12 →	998	B	M	3	12	P4JA, P4JB, P4JC, P4JD		84036	<b>NEW</b>
1.0 EcoBoost	48	01/13 →	998	B	M	3	12	XMJA, XMJB		84036	<b>NEW</b>
	59	10/12 →	998	B	M	3	12	P4JA, P4JB, P4JC, P4JD		84036	<b>NEW</b>
	74	01/13 →	998	B	M	3	12	SFJA, SFJB, SFJC, SFJD		84036	<b>NEW</b>
	92	09/12 →	998	B	M	3	12	M1JE		84036	<b>NEW</b>
	92	09/12 →	998	B	M	3	12	M1JE, M1JH		84036	<b>NEW</b>
	103	05/14 →	998	B	M	3	12	YYJA, YYJB		84036	<b>NEW</b>
1.0 Sport	103	05/14 →	998	B	M	3	12	YYJA, YYJB		84036	<b>NEW</b>
1.25	44	06/08 →	1.242	B	M	4	16	STJA, STJB		82027	
	44	10/12 →	1.242	B	M	4	16	STJB		82027	
	60	01/09 →	1.242	B	M	4	16	SNJA, SNJB		82027	
	60	06/08 →	1.242	B	M	4	16	SNJA, SNJB, SNJC, SNJD		82027	
1.4	71	06/08 →	1.388	B	M	4	16	SPJA, SPJC		82027	

	<b>KW</b>		<b>cm<sup>3</sup></b>				<b>NO. OF VALVES</b>		
--	-----------	--	-----------------------	--	--	--	----------------------	--	--

## FORD

### Fiesta VI, Van

1.4 LPG	68	01/09 →	1.388		M	4	16	RTJA, RTJB		82027
	71	01/09 →	1.388		M	4	16	RTJA, RTJB		82027
1.4 TDCi	50	01/09 →	1.399	D	M	4	8	F6JB		81798
	51	07/10 →	1.399	D	M	4	8	F6JD, KVJA		81798
	51	07/10 →	1.399	D	M	4	8	F6JD, KVJA		81869
1.5 TDCi	55	09/12 →	1.499	D	M	4	8	UGJC		81798
	55	09/12 →	1.499	D	M	4	8	UGJC		81869
1.6 ST	134	03/13 →	1.596	B	M	4	16	JTJA		82027
1.6 TDCi	55	06/08 →	1.560	D	M	4	16	HHJF, UBJA		81869
	66	06/08 →	1.560	D	M	4	16	HHJC, HHJD, HHJE		81869
	66	01/09 →	1.560	D	M	4	16	HHJC, HHJD, HHJE		81798
	70	02/10 →	1.560	D	M	4	8	T3JA, TZJA, TZJB		81869
	70	02/10 →	1.560	D	M	4	8	T3JA, TZJA, TZJB		81798
1.6 Ti	77	09/12 →	1.596	B	M	4	16	IQJA		82027
	88	06/08 →	1.596	B	M	4	16	HXJA, HXJB		82027
	99	12/10 →	1.596	B	M	4	16	U5JA		82027

### Focus C-Max

1.6	74	10/03 → 03/07	1.596	B	M	4	16	HWDA, HWDB	→ 04-2005	81598
	74	10/03 → 03/07	1.596	B	M	4	16	HWDA, HWDB	05-2005 →	82027
1.6 TDCi	66	02/05 → 03/07	1.560	D	M	4	16	HHDA, HHDB		81869
	80	10/03 → 03/07	1.560	D	M	4	16	G8DA, G8DB		81869
1.6 Ti	85	08/04 → 03/07	1.596	B	M	4	16	HXDA, SIDA	→ 04-2005	81598
	85	08/04 → 03/07	1.596	B	M	4	16	HXDA, SIDA	05-2005 →	82027
1.8	88	10/03 → 03/07	1.798	B	M	4	16	CSDA, CSDB		81804
	92	04/04 → 03/07	1.798	B	M	4	16	Q7DA, QQDA, QQDB		81804
1.8 Flexifuel	92	01/06 → 03/07	1.798		M	4	16	Q7DA		81804
1.8 TDCi	85	01/05 → 03/07	1.753	D	M	4	8	KKDA		81802
2.0	107	03/04 → 03/07	1.999	B	M	4	16	AODA, AODB, SYDA		81804
2.0 TDCi	98	10/03 → 03/07	1.997	D	M	4	16	G6DC, G6DE, G6DF		81800
	100	10/03 → 03/07	1.997	D	M	4	16	G6DA, G6DB, G6DD, G6DG		81800

### Focus I, Station Wagon

1.4 16V	55	10/98 → 11/04	1.388	B	M	4	16	FXDA, FXDB, FXDC, FXDD	10-1998 →	81598
	55	02/99 → 11/04	1.388	B	M	4	16	FXDA, FXDB, FXDC, FXDD		81598
1.6 16V	74	10/98 → 11/04	1.596	B	M	4	16	FYDA, FYDB, FYDC, FYDD, FYDH	10-1998 →	81598
	74	02/99 → 11/04	1.596	B	M	4	16	FYDA, FYDB, FYDC, FYDD, FYDH		81598
1.6 16V Flexifuel	75	01/02 → 11/04	1.596		M	4	16	FYDH		81598
1.8 16V	85	10/98 → 11/04	1.796	B	M	4	16	EYDB, EYDC, EYDD, EYDE, EYDF, EYDG, EYDI, EYDJ, EYDL		81803

**KW**

**cm<sup>3</sup>**

**NO. OF VALVES**

**FORD**
**Focus I, Station Wagon**

1.8 BiFuel	82	02/03 → 01/05	1.796	BF	M	4	16			81803
1.8 DI / TDDi	55	08/99 → 11/04	1.753	D	M	4	8	BHDA, BHDB		81802
1.8 TDCi	74	08/02 → 11/04	1.753	D	M	4	8	FFDA		81802
	85	03/01 → 11/04	1.753	D	M	4	8	F9DA, F9DB		81802
1.8 Turbo DI / TDDi	55	08/01 → 03/05	1.753	D	M	4	8	BHDA, BHDB		81802
	66	10/98 → 11/04	1.753	D	M	4	8	C9DA, C9DB, C9DC		81802
2.0 16V	96	10/98 → 11/04	1.988	B	M	4	16	EDDB, EDDC, EDDD, EDDF		81803
RS	158	10/02 → 11/04	1.988	B	M	4	16	HMDA		81803
ST170	127	03/02 → 11/04	1.988	B	M	4	16	ALDA		81803

**Focus II, Station Wagon, Cabrio**

1.4	59	07/04 → 09/12	1.388	B	M	4	16	ASDA, ASDB	→ 04-2005	81598
	59	07/04 → 09/12	1.388	B	M	4	16	ASDA, ASDB	05-2005 →	82027
	59	04/05 → 09/12	1.388	B	M	4	16	ASDA, ASDB		82027
1.6	74	07/04 → 09/12	1.596	B	M	4	16	HWDA, HWDB, SHDA, SHDB, SHDC	→ 04-2005	81598
	74	07/04 → 09/12	1.596	B	M	4	16	HWDA, HWDB, SHDA, SHDB, SHDC	05-2005 →	82027
	74	10/06 → 07/11	1.596	B	M	4	16	HWDA, HWDB, SHDA, SHDB, SHDC		82027
1.6 LPG	85	10/09 → 07/11	1.596		M	4	16	SIDA		82027
1.6 TDCi	66	01/05 → 09/12	1.560	D	M	4	16	GPDA, GPDB, GPDC, HHDA, HHDB		81869
	66	07/04 → 09/12	1.560	D	M	4	16	GPDA, GPDC, HHDA, HHDB		81869
	66	04/05 → 09/12	1.560	D	M	4	16	HHDA, HHDB		81869
	74	07/04 → 09/12	1.560	D	M	4	16	G8DC, MTDA		81798
	74	07/04 → 09/12	1.560	D	M	4	16	G8DC, MTDA		81869
	80	07/04 → 09/12	1.560	D	M	4	16	G8DA, G8DB, G8DD, G8DE, G8DF		81869
	81	12/07 → 09/12	1.560	D	M	4	16	G8DA		81798
1.6 Ti	85	07/04 → 09/12	1.596	B	M	4	16	HXDA, HXDB	→ 04-2005	81598
	85	07/04 → 09/12	1.596	B	M	4	16	HXDA, HXDB	05-2005 →	82027
	85	04/05 → 09/12	1.596	B	M	4	16	HXDA, HXDB		82027
	85	07/04 → 09/12	1.596	B	M	4	16	HXDA, HXDB, SIDA	→ 04-2005	81598
	85	07/04 → 09/12	1.596	B	M	4	16	HXDA, HXDB, SIDA	05-2005 →	82027
1.8	92	03/06 → 09/12	1.798	B	M	4	16	Q7DA, QQDB		81804
	92	03/06 → 09/12	1.798	B	M	4	16	QQDB		81804
1.8 Flexifuel	92	01/06 → 09/12	1.798		M	4	16	Q7DA		81804
	96	12/05 → 01/08	1.798		M	4	16	QQDD		81804
	96	12/05 → 01/08	1.798		M	4	16			81804
	97	12/05 → 01/08	1.798		M	4	16			81804
1.8 TDCi	85	01/05 → 09/12	1.753	D	M	4	8	KKDA, KKDB		81802

**KW**

**cm<sup>3</sup>**

**NO. OF VALVES**

**MAGNETI MARELLI**
**FORD**
**Focus II, Station Wagon, Cabrio**

2.0	107	10/06 → 07/11	1.999	B	M	4	16	AODA, AODB		81804
	107	07/04 → 09/12	1.999	B	M	4	16	AODA, AODB, AODE		81804
2.0 CNG	107	04/09 → 07/11	1.999		M	4	16	SYDA		81804
2.0 LPG	107	06/08 → 07/11	1.999		M	4	16	SYDA		81804
2.0 TDCi	81	02/08 → 07/11	1.997	D	M	4	16	IXDA		81800
	98	07/04 → 01/08	1.997	D	M	4	16	G6DE, G6DF		81800
	100	07/04 → 09/12	1.997	D	M	4	16	G6DA, G6DB, G6DD		81800
2.5 RS	224	01/09 → 07/11	2.521	B	M	5	20	JZDA		82056
2.5 RS 500	257	05/10 → 07/11	2.521	B	M	5	20	JZDA		82056
2.5 ST	166	10/05 → 09/12	2.522	B	M	5	20	HYDA		82056

**Focus III, Station Wagon, Van**

1.0 EcoBoost	74	02/12 →	998	B	M	3	12	M2DA		84036	<b>NEW</b>
	92	02/12 →	998	B	M	3	12	M1DA		84036	<b>NEW</b>
1.6 EcoBoost	110	07/10 →	1.596	B	M	4	16	JQDA, JQDB, YUDA		82027	
	134	07/10 →	1.596	B	M	4	16	JTDA, JTDB		82027	
1.6 Flexifuel	88	07/10 →	1.596		M	4	16	MUDA		82027	
	110	07/13 →	1.596		M	4	16	YUDA		82027	
1.6 LPG	86	02/12 →	1.596		M	4	16	MUDA		82027	
	88	02/12 →	1.596		M	4	16	MUDA		82027	
1.6 TDCi	70	07/10 →	1.560	D	M	4	8	T3DA, T3DB		81869	
	85	07/10 →	1.560	D	M	4	8	T1DA, T1DB		81869	
1.6 TDCi ECOnetic	77	05/12 →	1.560	D	M	4	8	NGDA, NGDB		81798	
	77	05/12 →	1.560	D	M	4	8	NGDA, NGDB		81869	
1.6 Ti	63	08/11 →	1.596	B	M	4	16	XTDA		82027	
	77	07/10 →	1.596	B	M	4	16	IQDB		82027	
	88	02/12 →	1.596	B	M	4	16	MUDA		82027	
	92	07/10 →	1.596	B	M	4	16	PNDA		82027	
2.0 ST	184	07/12 →	1.999	B	M	4	16	R9DA		81804	
2.0 TDCi	85	07/10 →	1.997	D	M	4	16	TYDA		84020	<b>NEW</b>
	100	07/10 →	1.997	D	M	4	16	UKDB		84020	<b>NEW</b>
	103	07/10 →	1.997	D	M	4	16	UFDB		84020	<b>NEW</b>
	110	11/14 →	1.997	D	M	4	16	T7DB		82068	
	120	07/10 →	1.997	D	M	4	16	TXDB		84020	<b>NEW</b>
	136	11/14 →	1.997	D	M	4	16	T8DA		82068	

**Fusion**

1.25	55	08/04 → 12/12	1.242	B	M	4	16	FUJA, FUJB	→ 04-2005	81598
	55	08/04 → 12/12	1.242	B	M	4	16	FUJA, FUJB	05-2005 →	82027
1.4	59	08/02 → 12/12	1.388	B	M	4	16	FXJA, FXJB, FXJC	→ 04-2005	81598
	59	08/02 → 12/12	1.388	B	M	4	16	FXJA, FXJB, FXJC	05-2005 →	82027
1.4 LPG	59	01/10 → 12/12	1.388		M	4	16	UTJA		82027
	59	01/10 → 12/12	1.388		M	4	16	UTJA		81598
1.4 TDCi	50	08/02 → 07/05	1.399	D	M	4	8	F6JA, F6JB		81798
1.6	74	08/02 → 11/08	1.596	B	M	4	16	FYJA, FYJB, FYJC	→ 04-2005	81598
	74	08/02 → 11/08	1.596	B	M	4	16	FYJA, FYJB, FYJC	05-2005 →	82027

**KW**

**cm<sup>3</sup>**

**NO. OF VALVES**

**MAGNETI MARELLI**
**FORD**
**Fusion**

1.6 TDCi	66	11/04 → 12/12	1.560	D	M	4	16	HHJA, HHJB		81869
----------	----	---------------	-------	---	---	---	----	------------	--	-------

**Galaxy I**

1.9 TDI	66	03/95 → 05/06	1.896	D	M	4	8	1Z, AHU, ANU	(-)COP, → 04-2000	81522
	66	03/95 → 05/06	1.896	D	M	4	8	1Z, AHU, ANU	(+)COP	82080
	66	03/95 → 05/06	1.896	D	M	4	8	1Z, AHU, ANU	(+)COP, → 04-2000	82080
	66	03/95 → 05/06	1.896	D	M	4	8	1Z, AHU, ANU	05-2000 →, M: ANU	81816
	66	03/95 → 05/06	1.896	D	M	4	8	1Z, AHU, ANU		84011 <b>NEW</b>
	81	08/97 → 04/00	1.896	D	M	4	8	AFN, AVG	(-)COP, → 04-2000	81522
	81	08/97 → 04/00	1.896	D	M	4	8	AFN, AVG	(+)COP	82080
	81	08/97 → 04/00	1.896	D	M	4	8	AFN, AVG	(+)COP, → 04-2000	82080
	85	04/00 → 05/06	1.896	D	M	4	8	AUY	M: VW19NPD	81816
	85	04/00 → 05/06	1.896	D	M	4	8	AUY		84011 <b>NEW</b>
	96	02/03 → 05/06	1.896	D	M	4	8	ASZ		84010 <b>NEW</b>
	96	02/03 → 05/06	1.896	D	M	4	8	ASZ		81791
	110	05/05 → 05/06	1.896	D	M	4	8	BTB		84010 <b>NEW</b>
	110	05/05 → 05/06	1.896	D	M	4	8	BTB		81791
2.8 i V6	128	11/95 → 04/00	2.792	B	M	6	12	AAA, AMY		81773
2.8 i V6 4x4	128	04/96 → 04/00	2.792	B	M	6	12	AAA, AMY		81773
2.8 V6	150	04/00 → 05/06	2.792	B	M	6	24	AYL		81773

**Galaxy II**

1.6 EcoBoost	118	11/10 → 06/15	1.596	B	M	4	16	JTWA, JTWB		82027
1.6 TDCi	85	02/11 → 06/15	1.560	D	M	4	8	T1WA, T1WB		81798
	85	02/11 → 06/15	1.560	D	M	4	8	T1WA, T1WB		81869
1.8 TDCi	74	05/06 → 06/15	1.753	D	M	4	8	FFWA		81802
	92	05/06 → 06/15	1.753	D	M	4	8	QYWA		81802
2.0	107	05/06 → 06/15	1.999	B	M	4	16	AOWA, AOWB		81804
2.0 EcoBoost	149	03/10 → 06/15	1.999	B	M	4	16	TNWA		81804
2.0 Flexifuel	107	05/06 → 06/15	1.999		M	4	16	TBWA, TBWB		81804
2.0 TDCi	85	11/07 → 06/15	1.997	D	M	4	16	KLWA, TYWA		81800
	96	05/06 → 06/15	1.997	D	M	4	16	AZWA		81800
	100	05/06 → 06/15	1.997	D	M	4	16	AZWC, UKWA	→ 05-2009	81800
	103	05/06 → 06/15	1.997	D	M	4	16	QXWA, QXWB, QXWC, UFWA		81800
	120	03/10 → 06/15	1.997	D	M	4	16	TXWA		84020 <b>NEW</b>
2.2 TDCi	129	03/08 → 12/12	2.179	D	M	4	16	Q4BA, Q4WA		82068
	147	11/10 → 06/15	2.179	D	M	4	16	KNWA		82068
2.3	118	09/07 → 06/15	2.261	B	M	4	16	SEWA		81804

**Galaxy III**

2.0 EcoBoost	176	01/15 →	1.999	B	M	4	16	R9CD, R9CI		81804
2.0 TDCi	110	01/15 →	1.997	D	M	4	16	T7CI, T7CJ, T7CK, T7CL		82068
	132	01/15 →	1.997	D	M	4	16	T8CG, T8CH, T8CI, T8CJ		82068



--	--	--	--	--	--	--	--	--	--

## FORD

### Galaxy III

2.0 TDCi 4x4	110	05/15 →	1.997	D	M	4	16			82068
	132	05/15 →	1.997	D	M	4	16	T8CG, T8CH, T8CI, T8CJ		82068
2.0 TDCi Bi-Turbo	154	01/15 →	1.997	D	M	4	16	T9CB, T9CC		82068

### Grand C-Max

1.0 EcoBoost	74	10/12 →	998	B	M	3	12	M2DA, SFDA		84036	
	92	10/12 →	998	B	M	3	12	M1DA		84036	
1.6 EcoBoost	110	12/10 →	1.596	B	M	4	16	JQDA, JQDB		82027	
	134	12/10 →	1.596	B	M	4	16	JTDA, JTDB		82027	
1.6 TDCi	70	12/10 →	1.560	D	M	4	8	T3DA, T3DB		81798	
	85	12/10 →	1.560	D	M	4	8	T1DA, T1DB		81798	
1.6 Ti	77	12/10 →	1.596	B	M	4	16	IQDA, IQDB		82027	
	92	12/10 →	1.596	B	M	4	16	PNDA		82027	
2.0 TDCi	85	02/11 →	1.997	D	M	4	16	TYDA		84020	
	100	02/11 →	1.997	D	M	4	16	UKDB		84020	
	103	02/11 →	1.997	D	M	4	16	UFDB		84020	
	120	12/10 →	1.997	D	M	4	16	TXDB		84020	

### KA I, StreetKa, Van

1.0 i	38	07/97 → 09/99	999	B	M	4	8	ZH10JRB		81716	
	48	09/99 → 11/08	999	B	M	4	8			81716	
1.3 i	36	06/98 → 11/08	1.299	B	M	4	8	JJD, JJF, JJG, JJH, JJJ		81716	
	37	09/96 → 10/02	1.299	B	M	4	8	JJB		81716	
	44	09/96 → 11/08	1.299	B	M	4	8	BAA, J4D, J4K, J4M, J4N, J4P, J4S	M: DU13BAYA, M: DU13BAA	82018	
	44	09/96 → 11/08	1.299	B	M	4	8	BAA, J4D, J4K, J4M, J4N, J4P, J4S	M: J4P, M: J4D, M: J4K, M: J4P	81716	
	44	05/02 → 05/05	1.299	B	M	4	8	BAA, J4D, J4K, J4M, J4N, J4P, J4S		82018	
	51	08/02 → 11/08	1.299	B	M	4	8	A9A, A9B		82018	
1.6	70	09/00 → 11/08	1.597	B	M	4	8	CDB, CDC		82018	
	70	05/03 → 07/05	1.599	B	M	4	8	CDRA, CDRB		82018	
1.6 i	71	11/05 → 09/08	1.597	B	M	4	8			82018	
	70	07/03 → 11/08	1.599	B	M	4	8	CDB, CDC		82018	

### KA II

1.2	51	10/08 →	1.242	B	M	4	8	FP4	PIERBURG	81369
1.3 TDCi	55	10/08 →	1.248	D	M	4	16	FD4		81862

### Kuga I

2.0 TDCi	100	03/08 → 11/12	1.997	D	M	4	16	G6DG, UKDA		81800	
	103	03/10 → 11/12	1.997	D	M	4	16	UFDA		84020	
2.0 TDCi 4x4	100	03/08 → 11/12	1.997	D	M	4	16	G6DG, UKDA		81800	
	103	03/10 → 11/12	1.997	D	M	4	16	UFDA		84020	
	120	03/10 → 11/12	1.998	D	M	4	16	TXDA		84020	
2.5	147	03/09 → 11/12	2.522	B	M	5	20	HYDB, HYDC		82056	
2.5 4x4	147	03/09 →	2.522	B	M	5	20	HYDB		82056	

**KW**

**cm<sup>3</sup>**

**NO. OF VALVES**

**MAGNETI MARELLI**
**FORD**
**Kuga II, Van**

1.6 EcoBoost	110	03/13 →	1.596	B	M	4	16	JQMA, JQMB		82027
1.6 EcoBoost 4x4	110	03/13 →	1.596	B	M	4	16	JQMA, JQMB		82027
	134	03/13 →	1.596	B	M	4	16	JTMA		82027
2.0 TDCi	100	03/13 →	1.997	D	M	4	16	UKMA		84020 <b>NEW</b>
	103	03/13 →	1.997	D	M	4	16	UFMA		84020 <b>NEW</b>
	88	09/14 →	1.998	D	M	4	16	XRMA, XRMB		84020 <b>NEW</b>
	110	09/14 →	1.998	D	M	4	16	T7MA, T7MB		84020 <b>NEW</b>
2.0 TDCi 4x4	100	03/13 →	1.997	D	M	4	16	UKMA		84020 <b>NEW</b>
	103	03/13 →	1.997	D	M	4	16	UFMA		84020 <b>NEW</b>
	110	09/14 →	1.998	D	M	4	16	T7MA, T7MB		84020 <b>NEW</b>
	120	03/13 →	1.998	D	M	4	16	TXDA, TXMA		84020 <b>NEW</b>
	132	09/14 →	1.998	D	M	4	16	T8MA, T8MB		82068

**Maverick II**

2.3 16V	110	03/04 →	2.261	B	M	4	16	GZ		81804
3.0 V6 24V	145	02/01 →	2.967	B	A	6	24	AJ	→ 03-2004	81845
	145	02/01 →	2.967	B	A	6	24	AJ	05-2003 →	82036
	149	03/04 →	2.967	B	M	6	24	AJ		82036

**Mondeo I, Station Wagon**

1.6 i 16V	65	07/94 → 08/96	1.597	B	M	4	16	L1J		82004
	66	02/93 → 08/96	1.597	B	M	4	16	L1F		82004
1.8 4x4	85	02/93 → 08/96	1.796	B	M	4	16	RKA		82004
1.8 i 16V	82	07/94 → 08/96	1.796	B	M	4	16	RKB		82004
	85	02/93 → 08/96	1.796	B	M	4	16	RKA		82004
1.8 i 16V 4x4	85	02/93 → 08/96	1.796	B	M	4	16	RKA		82004
1.8 TD	65	06/93 → 08/96	1.753	D	M	4	8	RFM, RFN		81656
	66	10/95 → 08/96	1.753	D	M	4	8	RFM, RFN		81656
2.0 i 16V	97	12/94 → 08/96	1.988	B	M	4	16	NGA		82004
	100	02/93 → 08/96	1.988	B	M	4	16	NGA	02-1993 →	82004
	100	04/93 → 08/96	1.988	B	M	4	16	NGA		82004
2.0 i 16V 4x4	97	12/94 → 08/96	1.988	B	M	4	16	NGA		82004
	100	04/93 → 08/96	1.988	B	M	4	16	NGA		82004
2.5 i 24V	125	07/94 → 08/96	2.544	B	M	6	24	SEA		81845

**Mondeo II, Station Wagon**

1.6 i	66	08/96 → 09/00	1.597	B	M	4	16	L1J		82004
1.6 i 16V	70	05/98 → 09/00	1.597	B	M	4	16	L1L, L1N, L1Q		82004
1.8 i	85	08/96 → 09/00	1.796	B	M	4	16	RKB, RKF, RKH, RKJ, RKK	→ 04-1998	82004
	85	08/96 → 09/00	1.796	B	M	4	16	RKB, RKF, RKH, RKJ, RKK		82004
1.8 TD	66	08/96 → 09/00	1.753	D	M	4	8	RFN		81656
2.0 i	96	08/96 → 09/00	1.988	B	M	4	16	NGA, NGB, NGC, NGD		82004
2.5 24V	125	06/00 → 09/00	2.495	B	M	6	24	LCBD, SEB, SEC		81845
	125	06/00 → 09/00	2.495	B	M	6	24	SEB, SEC		81845
	125	08/96 → 09/00	2.544	B	M	6	24	SEA		81845

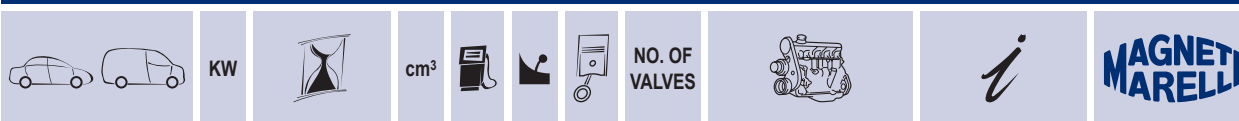

## FORD

### Mondeo II, Station Wagon

2.5 ST 200	151	05/99 → 09/00	2.495	B	M	6	24	SGA		81845
------------	-----	---------------	-------	---	---	---	----	-----	--	-------

### Mondeo III, Station Wagon

1.8 16V	81	10/00 → 03/07	1.798	B	M	4	16	CGBA, CGBB		81804
	92	10/00 → 03/07	1.798	B	M	4	16	CHBA, CHBB		81804
1.8 SCi	96	06/03 → 03/07	1.798	B	M	4	16	CFBA		81804
2.0 16V	107	10/00 → 03/07	1.999	B	AM	4	16	CJBA, CJBB		81804
2.0 16V DI / TDDi / TDCi	66	10/00 → 03/07	1.998	D	M	4	16	D5BA, SDBA		81805
2.0 16V TDDi / TDCi	85	10/00 → 03/07	1.998	D	M	4	16	D6BA, HJBA, HJBB, HJBC		81805
2.0 TDCi	96	10/01 → 03/07	1.998	D	M	4	16	FMBA, N7BA		81805
2.2 TDCi	110	09/04 → 03/07	2.198	D	M	4	16	QJBC, QJBD		81805
	114	09/04 → 03/07	2.198	D	M	4	16	QJBA, QJBB		81805
2.5 V6 24V	125	10/00 → 03/07	2.495	B	AM	6	24	LCBD		82036
3.0 V6 24V	150	09/04 → 03/07	2.967	B	M	6	24	REBA		82036
ST220	166	04/02 → 03/07	2.967	B	M	6	24	MEBA		82036

### Mondeo IV, Station Wagon

1.6 EcoBoost	118	02/11 → 09/14	1.596	B	M	4	16	JTBA		82027
	118	02/11 → 09/14	1.596	B	M	4	16	JTBB		82027
1.6 TDCi	85	02/11 → 09/14	1.560	D	M	4	8	T1BA, T1BB, T1BC		81869
1.6 Ti	81	03/07 → 09/14	1.596	B	M	4	16	RHBA		82027
	88	07/10 → 09/14	1.596	B	M	4	16	KGBA		82027
	92	03/07 → 09/14	1.596	B	M	4	16	PNBA		82027
1.8 TDCi	74	03/07 → 09/14	1.753	D	M	4	8	FFBA		81802
	92	06/07 →	1.753	D	M	4	8	KHBA, QYBA		81802
2.0	107	03/07 → 09/14	1.999	B	M	4	16	AOBA, AOBC, TBBA		81804
2.0 EcoBoost	176	07/10 → 09/14	1.999	B	M	4	16	TPBA		81804
2.0 Flexifuel	107	03/09 → 09/14	1.999		M	4	16	TBBA, TBBB		81804
2.0 LPG	107	07/09 → 09/14	1.999		M	4	16	TBBA		81804
2.0 SCTi	149	03/10 → 09/14	1.976	B	M	4	16	TNBA		81804
2.0 TDCi	85	11/07 → 09/14	1.997	D	M	4	16	KLBA, LPBA, TYBA		81800
	96	03/07 → 09/14	1.997	D	M	4	16	AZBA		81800
	100	03/07 → 09/14	1.997	D	M	4	16	AZBC, UKBA, UKBB		81800
	103	03/07 → 09/14	1.997	D	M	4	16	QXBA, QXBB, UFBA, UFBB		81800
	120	03/10 → 09/14	1.997	D	M	4	16	TXBA, TXBB		84020 <b>NEW</b>
	129	03/08 → 10/10	2.179	D	M	4	16	Q4BA		82068
	147	07/10 → 09/14	2.179	D	M	4	16	KNBA		82068
2.3	118	07/07 → 09/14	2.261	B	M	4	16	SEBA		81804
2.5	162	03/07 → 09/14	2.521	B	M	5	20	HUBA		82056

**KW**

**cm<sup>3</sup>**

**NO. OF VALVES**

**FORD**
**Mondeo V, Station Wagon**

1.0 EcoBoost	92	02/15 →	999	B	M	3	12	M1CA, M1CB		84036	<b>NEW</b>
2.0 EcoBoost	146	05/15 →	1.999	B	M	4	16	TNCC		81804	
	149	09/14 →	1.999	B	M	4	16	TNCD, TNCF		81804	
	176	09/14 →	1.999	B	M	4	16	R9CB, R9CF, R9CH		81804	
2.0 TDCi	110	09/14 →	1.998	D	M	4	16	T7CE		82068	
	132	09/14 →	1.998	D	M	4	16	T8CC		82068	
2.0 TDCi 4x4	110	02/15 →	1.998	D	M	4	16	T7CE		82068	
	132	02/15 →	1.998	D	M	4	16	T8CC		82068	
2.0 TDCi Bi-Turbo	154	03/15 →	1.998	D	M	4	16	T9CA		82068	
	154	05/15 →	1.998	D	M	4	16			82068	

**Orion II**

1.3	44	12/85 → 07/90	1.297	B	M	4	8	JBB, JLA, JLB		81531	
1.4	52	03/86 → 07/90	1.392	B	M	4	8	FUAA		81538	
	54	01/86 → 07/90	1.392	B	M	4	8	FUC		81538	
	55	12/85 → 07/90	1.392	B	M	4	8	FUA		81538	
1.4 Cat.	54	02/87 → 07/90	1.392	B	M	4	8	F6B, F6D		81538	
1.6	66	12/85 → 07/90	1.597	B	M	4	8	LUC		81538	
1.6 i	75	08/89 → 07/90	1.597	B	M	4	8	LJB		81538	
	77	03/86 → 07/90	1.597	B	M	4	8	LRB		81538	
1.6 i Cat.	66	03/86 → 07/90	1.597	B	M	4	8	L4B		81538	
1.8 D	44	01/89 → 07/90	1.753	D	M	4	8	RTA, RTB		81651	

**Orion III**

1.3	44	07/90 → 12/93	1.299	B	M	4	8	J4B, J6A	→ 04-1991	81650	
	44	07/90 → 12/93	1.299	B	M	4	8	J4B, J6A	05-1991 →	81653	
1.4	52	07/90 → 12/93	1.391	B	M	4	8	F6F, F6G		81538	
	54	07/90 → 12/93	1.392	B	M	4	8	FUH		81538	
1.6	66	07/90 → 12/92	1.598	B	M	4	8	LUJ, LUK		81538	
1.6 i	77	07/90 → 09/92	1.598	B	M	4	8	LJF		81538	
1.6 i 16V	66	07/92 → 12/93	1.597	B	M	4	16	L1E, L1K		81655	
1.8 D	44	11/90 → 12/93	1.753	D	M	4	8	RTE, RTF, RTH		81651	
1.8 i 16V	77	02/92 → 12/93	1.796	B	M	4	16	RDA		81655	
	96	01/92 → 12/93	1.796	B	M	4	16	RQB		81655	
1.8 TD	66	03/92 → 12/93	1.753	D	M	4	8	RFD, RFK		81657	

**P 100 II**

2.0	57	10/87 → 12/92	1.993	B	M	4	8	NAE		81602	
-----	----	---------------	-------	---	---	---	---	-----	--	-------	--

**Puma**

1.4 16V	66	11/97 → 10/00	1.388	B	M	4	16	FHD, FHF		81598	
1.6 16V	76	08/00 → 06/02	1.596	B	M	4	16	L1W		81598	
1.7 16V	92	03/97 → 06/02	1.679	B	M	4	16	MHA, MHB		81598	
ST 160	118	06/99 → 06/02	1.679	B	M	4	16			81598	

--	--	--	--	--	--	--	--	--	--

## FORD

### Scorpio I, Station Wagon

1.8	66	04/85 → 02/92	1.796	B	M	4	8	REC	10-1984 →, → 12-1990, VA	81602
2.0	77	03/90 → 08/92	1.998	B	M	4	8	N8B	→ 01-1991	81654
	80	11/88 → 10/92	1.998	B	M	4	8	N8A	→ 01-1991	81654
	80	06/89 → 03/93	1.998	B	M	4	8	N8B	→ 01-1991	81654
2.0 i	74	10/85 → 12/90	1.993	B	M	4	8	NRC		81602
	85	04/85 → 02/92	1.993	B	M	4	8	NRA, NRI	→ 12-1988	81602
	85	04/85 → 02/92	1.993	B	M	4	8	NRA, NRI	01-1989 →, → 01-1991	81654
2.5 TD	88	05/89 → 09/94	1.998	B	M	4	8	N9D	→ 01-1991	81654
	92	05/89 → 02/92	1.998	B	M	4	8	N9B	→ 01-1991	81654
	85	08/93 → 09/94	2.500	D	M	4	8	SCB	→ 09-1993	81302
	85	08/93 → 09/94	2.500	D	M	4	8	SCB		81302

### Scorpio II, Station Wagon

2.3 i 16V	108	06/96 → 08/98	2.295	B	M	4	16	Y5A		81654
2.5 TD	85	10/94 → 08/98	2.500	D	M	4	8	SCC	→ 09-1996	81302
	85	10/94 → 08/98	2.500	D	M	4	8	SCC	06-1996 →	81302
	92	09/96 → 08/98	2.500	D	M	4	8	VM	(-)COP	81362

### Sierra II, Station Wagon

1.6	53	01/88 → 02/93	1.597	B	M	4	8	LSF	(-)SS	81532
	53	01/88 → 02/93	1.597	B	M	4	8	LSF	(+)SS	81602
	53	01/88 → 02/93	1.597	B	M	4	8	LSF	(+)SS, VA	81602
	53	01/88 → 02/93	1.597	B	M	4	8	LSF		81532
	55	01/87 → 02/93	1.597	B	M	4	8	LSE	(+)SS	81602
	55	01/87 → 02/93	1.597	B	M	4	8	LSE		81532
1.6 i	59	10/89 → 02/93	1.597	B	M	4	8	L6B	(+)SS	81602
	59	10/89 → 02/93	1.597	B	M	4	8	L6B		81532
	59	10/89 → 02/93	1.598	B	M	4	8	L6B	(+)SS	81602
	59	10/89 → 02/93	1.598	B	M	4	8	L6B		81532
2.0	77	01/87 → 02/93	1.993	B	M	4	8	N8C, NES	(+)SS	81602
	77	01/87 → 02/93	1.993	B	M	4	8	N8C, NES	→ 01-1991	81654
	77	01/87 → 02/93	1.993	B	M	4	8	N8C, NES		81532
	80	07/89 → 12/92	1.998	B	M	4	8	N8A	(+)SS	81602
	80	07/89 → 12/92	1.998	B	M	4	8	N8A		81532
2.0 16V Cosworth 4x4	162	01/90 → 02/93	1.993	B	M	4	16	N5D		81602
2.0 16V Cosworth 4x4 Cat.	162	01/90 → 02/93	1.993	B	M	4	16	N5C		81602
2.0 4x4	88	01/90 → 02/93	1.998	B	M	4	8	N9C	(+)SS	81602
	88	01/90 → 02/93	1.998	B	M	4	8	N9C		81532
	88	02/90 → 02/93	1.998	B	M	4	8	N9C	→ 01-1991	81654
	92	01/90 → 02/93	1.998	B	M	4	8	N9C	→ 01-1991	81654

**KW**

**cm<sup>3</sup>**

**NO. OF VALVES**

**FORD**
**Sierra II, Station Wagon**

2.0 i	74	01/87 → 02/93	1.993	B	M	4	8	NE5, NEJ	(+)SS	81602
	74	01/87 → 02/93	1.993	B	M	4	8	NE5, NEJ		81532
	85	01/87 → 02/93	1.993	B	M	4	8	N4A, N4I	(+)SS	81602
	85	01/87 → 02/93	1.993	B	M	4	8	N4A, N4I	→ 01-1991	81654
	80	06/89 → 02/93	1.998	B	M	4	8	N8A	(+)SS	81602
	80	06/89 → 02/93	1.998	B	M	4	8	N8A		81532
	88	01/90 → 02/93	1.998	B	M	4	8	N9C	→ 01-1991	81654
	92	06/89 → 02/93	1.998	B	M	4	8	N9B	→ 01-1991	81654
	92	01/90 → 02/93	1.998	B	M	4	8	N9C	→ 01-1991	81654
2.0 i Cat.	74	01/87 → 02/93	1.993	B	M	4	8	N4B	(+)SS	81602
	74	01/87 → 02/93	1.993	B	M	4	8	N4B		81532
2.0 RS Cosworth	150	11/87 → 01/90	1.993	B	M	4	16	N5B		81602
<b>S-Max</b>										
1.6 EcoBoost	118	02/11 →	1.596	B	M	4	16	JTWA, JTWB		82027
1.6 TDCi	85	02/11 →	1.560	D	M	4	8	T1WA, T1WB		81798
	85	02/11 →	1.560	D	M	4	8	T1WA, T1WB		81869
1.8 TDCi	74	01/07 →	1.753	D	M	4	8	FFWA		81802
	92	05/06 →	1.753	D	M	4	8	QYWA		81802
2.0	107	05/06 →	1.999	B	M	4	16	AOWA, AOWB		81804
2.0 EcoBoost	146	07/10 →	1.999	B	M	4	16	TNWB		81804
	149	03/10 →	1.999	B	M	4	16	TNWA		81804
	176	02/15 →	1.999	B	M	4	16	R9CD, R9CI		81804
	176	07/10 →	1.999	B	M	4	16	TPWA		81804
2.0 Flexifuel	107	05/06 →	1.999		M	4	16	TBWA, TBWB		81804
2.0 TDCi	85	11/07 →	1.997	D	M	4	16	KLWA, TYWA		81800
	96	05/06 →	1.997	D	M	4	16	AZWA		81800
	100	05/06 →	1.997	D	M	4	16	AZWC, UKWA		81800
	103	05/06 →	1.997	D	M	4	16	QXWA, QXWB, QXWC, UFWA		81800
	110	02/15 →	1.997	D	M	4	16	T7CI, T7CJ, T7CK, T7CL		82068
	120	03/10 →	1.997	D	M	4	16	TXWA		84020 <b>NEW</b>
	132	02/15 →	1.997	D	M	4	16	T8CG, T8CH, T8CI, T8CJ		82068
2.0 TDCi 4x4	110	02/15 →	1.997	D	M	4	16	T7CI, T7CJ, T7CK, T7CL		82068
	132	02/15 →	1.997	D	M	4	16	T8CG, T8CH, T8CI, T8CJ		82068
2.0 TDCi Bi-Turbo	154	02/15 →	1.997	D	M	4	16	T9CB, T9CC		82068
2.2 TDCi	129	03/08 →	2.179	D	M	4	16	Q4WA		82068
	147	07/10 →	2.179	D	M	4	16	KNWA		82068
2.3	118	07/07 →	2.261	B	M	4	16	SEWA		81804
2.5 ST	162	05/06 →	2.521	B	M	5	20	HUWA		82056

--	--	--	--	--	--	--	--	--	--	--

## FORD

### Tourneo I Connect, Grand Tourneo Connect

1.8 16V	85	06/02 → 12/13	1.796	B	M	4	16	EYPA, EYPC, EYPD		81803
1.8 TDCi	66	06/02 → 12/13	1.753	D	M	4	8	HCPA, HCPB, P9PA, P9PB, P9PC, P9PD, R3PA, RWPE, RWPF		81802
	81	08/06 → 12/13	1.753	D	M	4	8	RWPA, RWPC, RWPD		81802
1.8 TDCi /TDDi /DI	55	06/02 → 12/13	1.753	D	M	4	8	BHPA, P7PA, P7PB, R2PA		81802

### Tourneo II Connect, Courier, Custom

1.0 EcoBoost	74	11/13 →	998	B	M	3	12	M2GA, M2GB		84036 <b>NEW</b>
1.6 EcoBoost	110	11/13 →	1.596	B	M	4	16	JQGA		82027
1.6 TDCi	55	09/13 →	1.560	D	M	4	8	UBGA		81798
	55	09/13 →	1.560	D	M	4	8	UBGA		81869
	70	09/13 →	1.560	D	M	4	8	TZGA, TZGB		81798
	70	09/13 →	1.560	D	M	4	8	TZGA, TZGB		81869
	85	09/13 →	1.560	D	M	4	8	T1GA		81798
	85	09/13 →	1.560	D	M	4	8	T1GA		81869
2.2 TDCi	74	04/12 →	2.198	D	M	4	16	DRF4, DRFF, DRFG		82066
	92	04/12 →	2.198	D	M	4	16	CYF4, CYFF		82066
	114	04/12 →	2.198	D	M	4	16	CVFF		82066

### Transit Connect I

1.8 16V	85	06/02 → 12/13	1.796	B	M	4	16	EYPA, EYPC, EYPD		81803
1.8 16V LPG	85	06/02 → 12/13	1.796		M	4	16	EYPC		81803
1.8 Di	55	06/02 → 12/13	1.753	D	M	4	8	BHPA, P7PA, P7PB, R2PA		81802
1.8 TDCi	66	06/02 → 12/13	1.753	D	M	4	8	HCPA, HCPB, P9PA, P9PB, P9PC, P9PD, R3PA, RWPE, RWPF		81802
	81	08/06 → 12/13	1.753	D	M	4	8	RWPA, RWPC, RWPD		81802

### Transit Connect II, Courier

1.0 EcoBoost	74	02/13 →	998	B	M	3	12	M2GA		84036 <b>NEW</b>
1.6 EcoBoost	110	11/13 →	1.596	B	M	4	16	JQGA		82027
1.6 TDCi	55	02/13 →	1.560	D	M	4	8	UBGA		81798
	55	02/13 →	1.560	D	M	4	8	UBGA		81869
	70	02/13 →	1.560	D	M	4	8	TZGA, TZGB		81798
	70	02/13 →	1.560	D	M	4	8	TZGA, TZGB		81869
	85	02/13 →	1.560	D	M	4	8	T1GA		81798
	85	02/13 →	1.560	D	M	4	8	T1GA		81869

### Transit Custom

2.2 TDCi	74	04/12 →	2.198	D	M	4	16	DRF4, DRFF, DRFG		82066
	92	04/12 →	2.198	D	M	4	16	CYF4, CYFF		82066
	114	04/12 →	2.198	D	M	4	16	CVFF		82066

**KW**

**cm<sup>3</sup>**

**NO. OF VALVES**

**FORD**
**Transit IV**

1.6	46	09/85 → 09/92	1.593	B	M	4	8	LAT	VA	81602
	46	09/85 → 09/92	1.593	B	M	4	8	LAT		81532
2.0	57	12/85 → 09/92	1.993	B	M	4	8	N6T	VA	81602
	57	12/85 → 09/92	1.993	B	M	4	8	N6T		81532
	57	11/85 → 09/92	1.994	B	M	4	8	NAT, NAV	VA	81602
	57	11/85 → 09/92	1.994	B	M	4	8	NAT, NAV		81532
2.5 D	50	01/86 → 09/91	2.496	D	M	4	8	4AB		81559
	52	09/88 → 09/92	2.496	D	M	4	8	4AB, 4BA, 4CA		81559
	52	10/88 → 09/91	2.496	D	M	4	8	4BA, 4CA		81559
2.5 DI	52	09/88 → 09/92	2.496	D	M	4	8	4BA, 4CA		81559

**Transit Tourneo I**

2.0	84	11/94 → 12/00	1.998	B	M	4	8	NSH		81602
2.4 D	55	08/94 → 06/00	2.496	D	M	4	8	4HA		81559
2.5 DI	51	11/94 → 12/00	2.496	D	M	4	8	4FA, 4FB, 4FC, 4FD		81559
	56	11/94 → 12/00	2.496	D	M	4	8	4HA, 4HB, 4HC		81559
2.5 TD	63	11/94 → 12/00	2.496	D	M	4	8	4GA, 4GB, 4GC		81559
	74	04/98 → 12/00	2.496	D	M	4	8	4EB, 4EC		81559

**Transit Tourneo II**

2.2 TDCi	81	07/06 → 08/14	2.198	D	M	4	16	QVFA		82066
	85	10/08 → 08/14	2.198	D	M	4	16	SRFA, SRFB, SRFC, SRFD, SRFE		82066
	96	07/06 → 08/14	2.198	D	M	4	16	QWFA		82066
	103	10/07 → 08/14	2.198	D	M	4	16	PGFA, PGFB, UHFA, UHFB		82066

**Transit V**

2.0	66	09/91 → 09/94	1.993	B	M	4	8	NBA		81602
	72	09/91 → 08/94	1.994	B	M	4	8	NCA		81602
2.0 i	72	09/91 → 07/94	1.994	B	M	4	8	NCA		81602
2.5 DI	51	09/91 → 08/94	2.496	D	M	4	8	4AB, 4BC, 4CC, 4FA		81559
	51	08/91 → 07/94	2.496	D	M	4	8	4BC, 4CC, 4FA		81559
	59	09/91 → 07/94	2.496	D	M	4	8	4DA		81559
	63	10/92 → 06/94	2.496	D	M	4	8	4GA		81559
2.5 TD	63	10/92 → 07/94	2.496	D	M	4	8	4GA, 4GB, 4GC		81559
	74	09/91 → 07/94	2.496	D	M	4	8	4EA		81559

**Transit VI**

2.0	84	09/95 → 03/00	1.998	B	M	4	8	NSF, NSG		81602
2.0 CNG	84	06/94 → 03/00	1.998		M	4	8	NSH		81602
2.5 DI	51	08/94 → 03/00	2.496	D	M	4	8	4FA, 4FB, 4FC, 4FD		81559
	56	07/94 → 03/00	2.496	D	M	4	8	4HB, 4HC		81559
	85	08/97 → 03/00	2.496	D	M	4	8	4ED		81559
2.5 TD	55	08/94 → 06/00	2.496	D	M	4	8	4HA, 4HD		81559
	63	01/95 → 03/00	2.496	D	M	4	8	4GA, 4GB, 4GC, 4GD, 4GE, 4GF		81559
	74	07/94 → 03/00	2.496	D	M	4	8	4EB, 4EC		81559



**KW**

**cm<sup>3</sup>**

**NO. OF VALVES**

**MAGNETI MARELLI**
**FORD**
**Transit VI**

2.5 TDI	74	06/94 → 03/00	2.496	D	M	4	8	4EB, 4EC		81559
---------	----	---------------	-------	---	---	---	---	----------	--	-------

**Transit VII**

2.0 DI	55	08/00 → 05/06	1.998	D	M	4	16	D3FA		81805
	63	08/00 → 05/06	1.998	D	M	4	16	F3FA		81805
	74	08/00 → 05/06	1.998	D	M	4	16	ABFA		81805
2.0 TDCi	92	08/02 → 05/06	1.998	D	M	4	16	F1FA		81805
	92	08/02 → 05/06	1.998	D	M	4	16	F1FA		81805
2.3	105	03/01 → 03/06	2.295	B	M	4	16	E5FC		81654
	107	08/00 → 03/06	2.295	B	M	4	16	E5FA		81654
2.3 16V	107	04/01 → 05/06	2.295	B	M	4	16	E5FA, E5FC		81654
2.3 16V [RWD]	107	08/00 → 05/06	2.295	B	M	4	16	E5FA, E5FC		81654
2.4 DI	55	01/00 → 05/06	2.402	D	M	4	16	F4FA		82057
	66	01/00 → 05/06	2.402	D	M	4	16	D2FA, D2FB, D2FE		82057
	88	01/00 → 05/06	2.402	D	M	4	16	D4FA		82057
2.4 DI [RWD]	55	01/00 → 05/06	2.402	D	M	4	16	F4FA		82057
	88	01/00 → 05/06	2.402	D	M	4	16	D4FA		82057
2.4 TD	55	08/00 → 08/03	2.402	D	M	4	16	F4FA		82057
2.4 TDCi	101	03/04 → 05/06	2.402	D	M	4	16	H9FA		82057
2.4 Tdci	66	10/01 → 03/06	2.402	D	M	4	16	D2FE		82057
	88	08/00 → 08/03	2.402	D	M	4	16	D4FA		82057
2.4 TDE	85	03/04 → 05/06	2.402	D	M	4	16	FXFA		82057
2.4 TDE	92	07/01 → 05/06	2.402	D	M	4	16	DOFA		82057
	92	07/01 → 05/06	2.402	D	M	4	16	DOFA		82057

**Transit XIII**

2.2 TDCi	63	04/06 → 08/14	2.198	D	M	4	16	P8FA, P8FB		82066
	74	10/11 → 08/14	2.198	D	M	4	16	DRFA, DRFB, DRFC, DRFD, DRFE		82066
	81	04/06 → 08/14	2.198	D	M	4	16	QVFA		82066
	85	10/08 → 08/14	2.198	D	M	4	16	SRFA, SRFB, SRFC, SRFD, SRFE		82066
	92	10/11 → 08/14	2.198	D	M	4	16	CYFA, CYFB, CYFC, CYFD		82066
	96	04/06 → 08/14	2.198	D	M	4	16	QWFA		82066
	103	10/07 → 08/14	2.198	D	M	4	16	PGFA, PGFB, UHFA, UHFB, UHFC		82066
2.3 16V [RWD]	107	04/06 → 08/14	2.261	B	M	4	16	GZFA, GZFB, GZFC		81654
2.4 TDCi	74	04/06 → 08/14	2.402	D	M	4	16	PHFA, PHFC		82057
	85	04/06 → 08/14	2.402	D	M	4	16	JXFA, JXFC		82057
	103	04/06 → 08/14	2.402	D	M	4	16	H9FD		82057
2.4 TDCi [RWD]	74	04/06 → 08/14	2.402	D	M	4	16	PHFA, PHFC		82057
	85	04/06 → 08/14	2.402	D	M	4	16	JXFA, JXFC		82057
	103	04/06 → 08/14	2.402	D	M	4	16	H9FB, H9FD		82057
	103	04/06 → 08/14	2.402	D	M	4	16	H9FD		82057
2.4 TDCi 4x4	103	11/06 → 08/14	2.402	D	M	4	16	H9FB		82057

**KW**

**cm<sup>3</sup>**

**NO. OF VALVES**

**HONDA**
**Accord IV, Aerodeck, Coupé**

2.0 16V	66	01/90 → 03/93	1.997	B	M	4	16	F20A6		81708
	81	01/90 → 03/93	1.997	B	M	4	16	F20A2, F20A3		81708
2.0 i 16V	98	01/90 → 03/93	1.997	B	M	4	16	F20A4, F20A8		81708
	98	01/92 → 09/93	1.997	B	M	4	16	F20A7		81708
	98	03/93 → 12/93	1.997	B	M	4	16	F20Z3		81708
2.2 i 16V	108	01/91 → 12/93	2.156	B	M	4	16	F22A8		81708
	110	01/90 → 03/93	2.156	B	M	4	16	F22A3		81708
	110	01/91 → 12/93	2.156	B	M	4	16	F22A7		81708
2.2 i 16V Automatic	108	01/90 → 03/93	2.156	B	M	4	16	F22A3		81708

**Accord V, Aerodeck, Coupé**

1.9 i	85	02/96 → 10/98	1.850	B	M	4	16	F18A3		81708
2.0	100	09/93 → 12/97	1.997	B	M	4	16	F20B3		81708
2.0 i	85	03/93 → 01/96	1.997	B	M	4	16	F20Z2		81708
2.0 i LS	96	02/96 → 10/98	1.997	B	M	4	16	F20Z1		81708
2.0 i LS 16V	100	09/93 → 02/98	1.997	B	M	4	16	F20B3		81708
2.0 i S	96	03/93 → 01/96	1.997	B	M	4	16	F20Z1		81708
2.0 TDi	77	04/96 → 10/98	1.994	D	M	4	8	20T2N		81707
2.2 i ES	110	09/93 → 02/98	2.156	B	M	4	16	F22B5		81708
2.2 i VTEC	110	02/96 → 10/98	2.156	B	M	4	16	F22Z2		81708
2.3 i SR	116	03/93 → 01/96	2.259	B	M	4	16	H23A3		81709

**Accord VI, Aerodeck, Hatchback, Coupé**

1.6	85	12/99 → 12/02	1.590	B	M	4	16	D16B6		81838
	65	10/98 → 12/02	1.598	B	M	4	12	A16A5		81838
1.6 i	85	10/98 → 12/02	1.590	B	M	4	16	D16B6		81838
1.6 LS	79	10/98 → 12/02	1.590	B	M	4	16	D16B7		81838
2.0	108	12/99 → 12/02	1.997	B	M	4	16	F20B6		81708
2.0 i	108	10/98 → 01/01	1.997	B	M	4	16	F20B6		81708
2.0 i 16V	108	02/98 → 06/03	1.997	B	M	4	16	F20B5, F20B7		81708
2.0 TDi	77	12/99 → 10/00	1.994	D	M	4	8	20T2N		81707
2.0 Turbo DI	77	02/99 → 12/02	1.994	D	M	4	8	20T2N		81707
2.3	113	01/01 → 06/03	2.254	B	M	4	16	F23A1, F23Z5		81708
	113	11/00 → 12/02	2.254	B	M	4	16	F23Z5		81708
2.3 16 V	118	02/98 →	2.254	B	M	4	16	F23A7		81708
2.3 VTi	113	02/98 → 10/02	2.254	B	M	4	16	F23A3		81708

**Accord VII, Aerodeck, Hatchback, Coupé**

2.0	114	02/03 → 05/08	1.998	B	AM	4	16	K20A6		81708
	114	04/03 → 05/08	1.998	B	M	4	16	K20A6		81708
2.0 Trazione integrale	114	02/03 → 05/08	1.998	B	AM	4	16	K20A6		81708
2.2 i-CTDi	103	01/04 → 05/08	2.204	D	M	4	16	N22A1		82093

**Civic II Shuttle**

1.4 i 16V	66	01/88 → 12/92	1.396	B	M	4	16	D14A1		81613
1.5 i 16V	69	01/88 → 11/91	1.493	B	M	4	16	D15B2		81613
1.6 4x4	85	01/88 → 12/92	1.590	B	M	4	16	D16A, D16A7		81613
1.6 i 16V 4WD	81	01/88 → 02/95	1.590	B	M	4	16	D16A6		81613

		KW		cm <sup>3</sup>				NO. OF VALVES			
--	--	----	--	-----------------	--	--	--	---------------	--	--	--

## HONDA

### Civic IV, Hatchback

1.3 16 V	55	09/89 → 09/91	1.343	B	M	4	16	D13B2		81611
1.5 i 16V	66	10/88 → 09/91	1.493	B	M	4	16	D15B2		81613
	69	10/88 → 09/91	1.493	B	M	4	16	D15B2		81613
1.6 4x4	110	01/88 → 12/91	1.590	B	M	4	16	D16W4		81613
1.6 i 16V	96	09/87 → 09/91	1.590	B	M	4	16	D16A7		81613
	96	09/87 → 09/91	1.590	B	M	4	16	D16A7, D16A9		81613
	80	10/87 → 09/91	1.590	B	M	4	16	D16A6		81613
	81	10/87 → 09/91	1.590	B	M	4	16	D16Z2		81613
1.6 i 16V 4x4	80	10/89 → 09/91	1.590	B	M	4	16	D16A6		81613
1.6 i 16V Vtec	110	10/89 → 09/91	1.595	B	M	4	16	B16A1		81613

### Civic IX, Hatchback, Coupé

1.4 i-VTEC	73	02/12 →	1.339	B	M	4	16	L13Z4		84065	<b>NEW</b>
------------	----	---------	-------	---	---	---	----	-------	--	-------	------------

### Civic V, Hatchback, Coupé

1.3 16V	55	10/91 → 11/95	1.343	B	M	4	16	D13B2		81613
1.5	61	01/92 → 12/92	1.493	B	M	4	16	D15B2		81613
	66	10/93 → 12/95	1.493	B	M	4	16	D15B2		81613
	74	10/93 → 12/95	1.493	B	M	4	16	D15B2, D15Z1		81613
1.5 i 16V	66	10/91 → 11/95	1.493	B	M	4	16	D15B2, D15Z2		81613
	69	10/91 → 11/95	1.493	B	M	4	16	D15B2, D15Z1		81613
1.5 i LSi	74	08/93 → 11/95	1.493	B	M	4	16	D15B7		81613
1.6 16V Vtec	92	10/91 → 11/95	1.590	B	M	4	16	D16Z6		81613
1.6 4x4	92	01/92 → 10/95	1.590	B	M	4	16	D16Z7		81613
1.6 EX	88	08/93 → 10/95	1.590	B	M	4	16	D16A7		81613
1.6 i	77	01/94 → 11/95	1.590	B	M	4	16	D16Y7		81613
1.6 i Vtec	118	01/94 → 11/95	1.595	B	M	4	16	B16A2		81839
	92	01/94 → 03/96	1.590	B	M	4	16	D16Y6, D16Z9		81613
1.6 VTi	118	10/91 → 11/95	1.595	B	M	4	16	B16A2		81839
1.6 VTi 16V	118	10/91 → 11/95	1.595	B	M	4	16	B16A2		81839

### Civic VI, Hatchback, Aerodeck, Fastback, Coupé

1.4	55	11/95 → 10/98	1.396	B	M	4	16	D14A4		81613
1.4 16V	55	04/98 → 02/01	1.396	B	M	4	16	D14A7	M: SOHC	81838
	66	04/98 → 02/01	1.396	B	M	4	16	D14A8	M: SOHC	81838
1.4 i	55	11/95 → 02/01	1.396	B	M	4	16	D14A3, D14Z1		81838
	55	09/95 → 02/01	1.396	B	M	4	16	D14A5, D14A7, D14Z3		81613
	66	09/94 → 02/01	1.396	B	M	4	16	D14A2, D14A6, D14A8, D14Z4		81613
	66	11/95 → 02/01	1.396	B	M	4	16	D14A4, D14Z2, D14Z4		81613
1.4 i S	66	11/95 → 02/01	1.396	B	M	4	16	D14A4, D14Z2, D14Z4		81613
1.5 16V	84	04/98 → 02/01	1.493	B	M	4	16	D15Z8		81838
1.5 i	84	11/95 → 02/01	1.493	B	M	4	16	D15Z6		81838
1.5 i Vtec-E	66	09/94 → 01/97	1.493	B	M	4	16	D15Z3		81613
1.6	92	11/98 → 10/00	1.590	B	M	4	16	D16W4		81838
	93	10/95 → 09/00	1.590	B	M	4	16	D16Y2		81613
1.6 16V	85	04/98 → 02/01	1.590	B	M	4	16	D16B2		81838

**KW**

**cm<sup>3</sup>**

**NO. OF VALVES**

**MAGNETI MARELLI**
**HONDA**
**Civic VI, Hatchback, Aerodeck, Fastback, Coupé**

1.6 i	77	03/96 → 03/00	1.590	B	M	4	16	D16Y7	M: SOHC	81838
	83	09/94 → 01/97	1.590	B	M	4	16	D16Y3		81613
	84	11/95 → 02/01	1.590	B	M	4	16	D16Y5		81838
1.6 i Vtec	92	11/95 → 02/01	1.590	B	M	4	16	D16Y6, D16Y8		81838
	92	03/96 → 03/00	1.590	B	M	4	16	D16Y8		81838
	118	04/99 → 12/00	1.595	B	M	4	16	B16A2		81839
1.6 VTi	93	09/94 → 01/97	1.590	B	M	4	16	D16Y2		81613
	118	01/97 → 02/01	1.595	B	M	4	16	B16A2		81839
	118	11/95 → 02/01	1.595	B	M	4	16	B16A2		81839
1.8 16V	124	04/98 → 02/01	1.797	B	M	4	16	B18C4		81839
2.0 i D	77	04/98 → 02/01	1.994	D	M	4	8	20T2N		81707
2.0 i TD	63	01/97 → 02/01	1.994	D	M	4	8	20T2R		81707
2.0 TDiC	77	11/98 → 10/00	1.994	D	M	4	8	20T2N		81707
	74	11/98 → 10/00	1.994	D	M	4	8	20T2N		81707

**Civic VII, Hatchback, Coupé**

1.4	66	12/00 → 09/05	1.396	B	M	4	16	D14Z5		82039
1.4 i	55	02/01 → 09/05	1.396	B	M	4	16	D14Z6		81838
1.4 iS	66	02/01 → 09/05	1.396	B	AM	4	16	D14Z5, D14Z6		82039
1.6	84	02/01 → 09/05	1.586	B	M	4	16	R16A1		82039
	81	02/01 → 09/05	1.590	B	M	4	16	D16V1		82039
1.6 i	81	02/01 → 12/05	1.590	B	AM	4	16	D16V1		82039
1.7	85	02/01 → 09/05	1.668	B	M	4	16	D17A6		82039
1.7 i	88	05/01 → 12/05	1.668	B	M	4	16	D17A8		82039
1.7 i VTEC	92	05/01 → 12/05	1.668	B	M	4	16	D17A5, D17A9		82039

**Civic VIII, Hatchback, Coupé**

1.4	61	09/05 →	1.339	B	M	4	8	L13A7		82045
	73	10/08 →	1.339	B	M	4	16	L13Z1		84065 <b>NEW</b>
2.2 CTDi	103	09/05 →	2.204	D	M	4	16	N22A2		82093

**Concerto**

1.4	61	10/89 → 10/92	1.396	B	M	4	16	D14A1		81613
	66	08/89 → 10/91	1.396	B	M	4	16	D14A1, D14A8		81613
1.5 i 16V	66	08/89 → 03/95	1.493	B	M	4	16	D15B2		81613
1.6	96	10/89 → 10/92	1.590	B	M	4	16	D16A9		81613
1.6 16V	78	08/89 → 03/95	1.590	B	M	4	16	D16Z2		81613
1.6 i 16V	82	08/89 → 03/95	1.590	B	M	4	16	D16Z2		81613
	90	08/89 → 03/95	1.590	B	M	4	16	D16A8		81613

**CR-V II**

2.2 CTDi	103	02/05 → 09/06	2.204	D	M	4	16	N22A2		82093
----------	-----	---------------	-------	---	---	---	----	-------	--	-------

**CR-V III**

2.2 i-CTDi 4WD	103	01/07 →	2.204	D	M	4	16	N22A2		82093
----------------	-----	---------	-------	---	---	---	----	-------	--	-------

**CRX II**

1.6 i 16V	91	10/87 → 02/92	1.590	B	M	4	16	D16Z5		81613
1.6 i 16V Vtec	110	10/89 → 02/92	1.595	B	M	4	16	B16A1		81613

		KW		cm <sup>3</sup>				NO. OF VALVES		
--	--	----	--	-----------------	--	--	--	---------------	--	--

## HONDA

### CRX III

1.6 ESi	92	03/92 → 12/98	1.590	B	M	4	16	D16Y8, D16Z6	81613
1.6 i VTi	118	03/92 → 12/98	1.595	B	M	4	16	B16A2	81613

### FR-V

1.7	92	08/04 →	1.668	B	M	4	16	D17A2	82039
2.2 i CTDi	103	07/05 →	2.204	D	M	4	16	N22A1	82093

### HR-V

1.6 16V	77	03/99 →	1.590	B	M	4	16	D16W1	81838
1.6 16V 4WD	77	03/99 →	1.590	B	M	4	16	D16W1	81838
	91	10/99 →	1.590	B	M	4	16	D16W5	81838

### Integra II

1.8 Type-R	140	11/97 → 10/01	1.797	B	M	4	16	B18C6	81839
------------	-----	---------------	-------	---	---	---	----	-------	-------

### Jazz II

1.2	57	03/02 → 07/08	1.243	B	M	4	8	L12A1	82045
1.3	61	03/02 → 07/08	1.339	B	M	4	8	L13A1	82045

### Jazz III

1.2	66	07/08 →	1.198	B	M	4	16	L12B1	82045
1.3 i	73	07/08 →	1.339	B	M	4	16	L13Z1	82045

### Prelude IV

2.0 i 16V	98	02/92 → 09/96	1.997	B	M	4	16	F20A4	81708
2.2 i 16V Vtec	136	02/93 → 09/96	2.157	B	M	4	16	H22A2	81708
2.3 i 16V	118	02/92 → 09/96	2.259	B	M	4	16	H23A2	81709

### Prelude V

2.0 16V	98	10/96 → 10/00	1.997	B	M	4	16	F20A4	81708
2.2 16V	147	10/96 → 10/00	2.157	B	M	4	16	H22A5	81708
	136	10/96 → 10/00	2.157	B	M	4	16	H22A2, H22A5	81708

### Shuttle

2.2 16V	110	10/94 → 02/98	2.156	B	M	4	16	F22B8	81708
2.2 4x4	102	06/94 → 09/97	2.156	B	M	4	16	F22B9	81708
2.3 16V	110	10/97 → 06/04	2.254	B	M	4	16	F23A7	81708
2.3 16V 4x4	110	10/97 → 06/02	2.254	B	M	4	16	F23A	81708

### Stream I

1.7 16V	92	05/01 →	1.668	B	M	4	16	D17A2	82039
2.0 16V	115	05/01 →	1.998	B	M	4	16	K20A1	82039

## HYUNDAI

### Accent I

1.3	40	09/95 → 05/98	1.341	B	M	4	12	G4EH	82020
	44	10/94 → 01/00	1.341	B	M	4	12	G4EH	81784
	55	10/94 → 01/00	1.341	B	M	4	12	G4EH	81784
1.3 i 12V	62	10/94 → 01/00	1.341	B	M	4	12	G4EH	81784
1.5 i 12V	65	10/94 → 01/00	1.495	B	M	4	12	G4EK	81784
1.5 i 16V	73	12/95 → 01/00	1.495	B	M	4	16	G4ER	82020

**KW**

**cm<sup>3</sup>**

**NO. OF VALVES**

**MAGNETI MARELLI**
**HYUNDAI**
**Accent II**

1.3	55	01/00 → 11/05	1.341	B	M	4	12	G4EA		81784
	61	01/00 → 11/05	1.341	B	M	4	12	G4EA		81784
	62	08/02 → 11/05	1.341	B	M	4	12	G4EH		81784
	63	01/00 → 11/05	1.341	B	A	4	12	G4EA		81784
1.5	66	01/00 → 11/05	1.495	B	M	4	12	G4EB		82020
	75	09/00 → 11/05	1.495	B	AM	4	16	G4EC-G		82020
	75	09/99 → 10/02	1.495	B	M	4	16	G4FK		82020
1.5 CRDi	60	04/02 → 11/05	1.493	D	M	3	12	D3EA		82085
1.6	77	12/02 → 11/05	1.599	B	M	4	16	G4ED-G		82020

**Accent III**

1.4 GL	71	11/05 → 11/10	1.399	B	M	4	16	G4EE		82020
1.5 CRDi GLS	81	11/05 → 11/10	1.493	D	M	4	16	D4FA		84058 <b>NEW</b>
1.6 GLS	82	11/05 → 11/10	1.599	B	M	4	16	G4ED		82020

**Atos, Atos Prime**

0.8	38	04/99 → 07/03	798	B	M	3	6	G3HJ		81837
1.0 i	40	02/98 → 03/02	999	B	AM	4	12	G4HC		81837
	43	03/01 →	999	B	M	4	12	G4HC-E		81837
1.1	43	06/03 →	1.086	B	M	4	12	G4HD		84018 <b>NEW</b>
	43	08/03 → 05/05	1.086	B	M	4	12	G4HD		81837
	46	03/04 →	1.086	B	M	4	12	G4HG		84018 <b>NEW</b>

**Coupé I**

1.6 16V	77	03/02 → 08/09	1.599	B	M	4	16	G4ED-G		82020
	79	03/02 → 08/09	1.599	B	M	4	16	G4ED-G		82020
	85	03/98 → 04/02	1.599	B	M	4	16	G4GR		81785
1.6 i 16V	84	12/96 → 04/02	1.599	B	M	4	16	4G61		81785
2.0	100	08/01 → 08/09	1.975	B	M	4	16	G4GC-G		81785
	101	08/99 → 01/02	1.975	B	M	4	16	G4DF		81785
	102	03/02 → 08/09	1.975	B	M	4	16	G4GC-G		81785
2.0 16V	99	03/01 → 04/02	1.975	B	M	4	16	G4DF		81785
	102	08/96 → 04/02	1.975	B	M	4	16	G4GF		81785
2.0 GLS	105	02/03 → 08/09	1.975	B	M	4	16	G4GC-G		81785
2.7 V6	121	01/07 → 08/09	2.656	B	M	6	24	G6BA-G		82021
	123	03/02 → 08/09	2.656	B	M	6	24	G6BA-G		82021

**Elantra I**

1.6	66	06/00 → 07/06	1.599	B	M	4	16	G4GR		82020
	77	05/03 → 07/06	1.599	B	M	4	16	G4ED-G		82020
	79	06/00 → 07/06	1.599	B	AM	4	16	G4ED-G		82020
	82	09/03 → 07/06	1.599	B	M	4	16	G4GA		82020
1.8	79	06/00 → 07/03	1.795	B	M	4	16	G4BB		81785
	97	06/00 → 07/06	1.795	B	M	4	16	G4BB		81785
2.0	102	06/00 → 07/06	1.975	B	M	4	16	G4GC-G		81785
	104	06/00 → 07/06	1.975	B	AM	4	16	G4GC		81785
	105	10/03 → 07/06	1.975	B	M	4	16	G4GC		81785
2.0 CRDi	83	04/01 → 07/06	1.991	D	M	4	16	D4EA		82085

--	--	--	--	--	--	--	--	--	--

## HYUNDAI

### Elantra II

1.6 CVVT	90	06/06 → 06/11	1.591	B	M	4	16	G4FC		84015	
2.0 CVVT	105	06/06 → 06/11	1.975	B	M	4	16	G4GC	→ 10-2006	84015	
	105	06/06 → 06/11	1.975	B	M	4	16	G4GC	11-2006 →	81785	

### Elantra III

1.6	97	06/11 →	1.591	B	M	4	16	G4FG		84015	
1.8	110	09/10 →	1.797	B	M	4	16	G4NB-B		84064	

### Galopper I

2.5 Tci D	77	08/98 → 12/03	2.476	D	M	4	8	D4BH		81787	
2.5 TD	65	08/98 → 12/03	2.476	D	M	4	8	D4BA		81787	
	62	08/91 → 07/98	2.477	D	M	4	8	4D56T		81787	
2.5 TD intercooler	70	08/91 → 07/98	2.477	D	M	4	8	4D56T		81787	

### Getz

1.1	46	09/02 → 09/05	1.086	B	M	4	12	G4HD		84018	
	49	09/05 → 06/09	1.086	B	M	4	12	G4HD, G4HG		82020	
1.3	63	09/03 → 09/05	1.341	B	M	4	12	G4EA		81784	
1.3 i	60	09/02 → 03/04	1.341	B	M	4	12	G4EA		81784	
1.4 i	71	08/05 →	1.399	B	M	4	16	G4EE		82020	
1.5 CRDi	60	03/03 → 09/05	1.493	D	M	3	12	D3EA		82085	
	65	08/05 → 06/09	1.493	D	M	4	16	D4FA		84058	
1.5 CRDi GLS	75	07/04 → 08/05	1.493	D	M	4	16	D4FA		84058	
	81	08/05 → 06/09	1.493	D	M	4	16	D4FA		84058	
1.6	77	09/02 → 09/05	1.599	B	M	4	16	G4ED-G		82020	
	78	08/05 →	1.599	B	M	4	16	G4ED-G		82020	

### Grace

2.5 TD	59	06/98 → 10/01	2.476	D	M	4	8	D4BF		81787	
--------	----	---------------	-------	---	---	---	---	------	--	-------	--

### Grandeur III

2.2 CRDi	110	06/06 →	2.188	D	M	4	16	D4EB		84059	
	114	06/06 →	2.188	D	M	4	16	D4EB		84059	

### H 100

2.5 D	55	07/93 → 12/94	2.477	D	M	4	8	D4BA, D4BX		81787	
	57	12/94 → 03/00	2.477	D	M	4	8	D4BA		81787	
2.5 TD	59	07/93 → 03/00	2.476	D	M	4	8	D4BF		81787	
2.5 TDiC	59	06/98 → 10/03	2.476	D	M	4	8	D4BF		81787	

### Highway Van

2.7 V6 24V	125	03/00 →	2.656	B	A	6	24	G6BA		82021	
------------	-----	---------	-------	---	---	---	----	------	--	-------	--

### i10 I

1.1	48	12/07 →	1.086	B	M	4	12	G4HG		84018	
	49	01/08 →	1.086	B	M	4	12	G4HG		84018	
	51	04/11 →	1.086	B	M	4	12	G4HG		84018	
1.2	57	11/08 →	1.248	B	M	4	16	G4LA		84015	
	63	04/11 →	1.248	B	M	4	16	G4LA		84040	

### i10 II

1.2	64	12/13 →	1.248	B	M	4	16	G4LA		84040	
-----	----	---------	-------	---	---	---	----	------	--	-------	--

**KW**

**cm<sup>3</sup>**

**NO. OF VALVES**

**MAGNETI MARELLI**
**HYUNDAI**
**i20 I**

1.1 CRDi	55	03/12 →	1.120	D	M	3	12	D3FA		84063	<b>NEW</b>
1.2	57	09/08 →	1.248	B	M	4	16	G4LA		84040	<b>NEW</b>
	63	03/12 →	1.248	B	M	4	16	G4LA		84040	<b>NEW</b>
1.4	74	09/08 →	1.396	B	M	4	16	G4FA		84015	<b>NEW</b>
1.6	93	09/08 →	1.591	B	M	4	16	G4FC		84015	<b>NEW</b>
1.6 CRDi	94	01/09 →	1.582	D	M	4	16	D4FB		84063	<b>NEW</b>

**i20 II, Coupé**

1.2	55	11/14 →	1.248	B	M	4	16	G4LA		84040	<b>NEW</b>
	62	11/14 →	1.248	B	M	4	16	G4LA		84040	<b>NEW</b>

**i30 I, Station Wagon**

1.4	77	10/07 → 11/11	1.396	B	M	4	16	G4FA		84015	<b>NEW</b>
	80	10/07 → 11/11	1.396	B	M	4	16	G4FA		84015	<b>NEW</b>
1.6	85	10/07 → 11/11	1.591	B	M	4	16	G4FC		84015	<b>NEW</b>
	90	10/07 → 11/11	1.591	B	M	4	16	G4FC		84015	<b>NEW</b>
	93	02/08 → 11/11	1.591	B	M	4	16	G4FC		84015	<b>NEW</b>
1.6 CRDi	66	10/07 → 11/11	1.582	D	M	4	16	D4FB		84058	<b>NEW</b>
	85	10/07 → 11/11	1.582	D	M	4	16	D4FB		84058	<b>NEW</b>
	94	01/10 → 11/11	1.582	D	M	4	16	D4FB		84058	<b>NEW</b>
2.0	105	10/07 → 11/11	1.975	B	M	4	16	G4GC, G4GC-G		81785	
2.0 CRDi	100	10/07 → 11/11	1.991	D	M	4	16	D4EA		84059	<b>NEW</b>
	103	10/07 → 11/11	1.991	D	M	4	16	D4EA		84059	<b>NEW</b>

**i30 II, Station Wagon, Coupé**

1.4	74	01/15 →	1.368	B	M	4	16	G4LC	→ 12-2014	84015	<b>NEW</b>
	73	12/11 →	1.396	B	M	4	16	G4FA	→ 12-2014	84015	<b>NEW</b>
	73	06/12 →	1.396	B	M	4	16	G4FA		84015	<b>NEW</b>
1.4 CRDi	66	12/11 →	1.396	D	M	4	16	D4FC		84063	<b>NEW</b>
1.6	88	01/12 →	1.591	B	M	4	16	G4FC		84015	<b>NEW</b>
	88	06/12 →	1.591	B	M	4	16	G4FG		84015	<b>NEW</b>
	95	06/12 →	1.591	B	M	4	16	G4FG		84015	<b>NEW</b>
1.6 CRDi	81	12/11 →	1.582	D	M	4	16	D4FB		84063	<b>NEW</b>
	94	12/11 →	1.582	D	M	4	16	D4FB		84063	<b>NEW</b>
	94	06/12 →	1.582	D	M	4	16	D4FB-5P		84063	<b>NEW</b>
1.6 GDI	95	12/11 →	1.591	B	M	4	16	G4FG		84015	<b>NEW</b>
	99	12/11 →	1.591	B	M	4	16	G4FD		84015	<b>NEW</b>
1.6 T-GDI	137	01/15 →	1.591	B	M	4	16	G4FJ		84015	<b>NEW</b>

**i40**

1.6 GDI	99	03/12 →	1.591	B	M	4	16	G4FD		84015	<b>NEW</b>
2.0 GDI	130	07/11 →	1.999	B	M	4	16	G4NC		84064	<b>NEW</b>
	131	03/12 →	1.999	B	M	4	16	G4NC		84064	<b>NEW</b>

**ix 20**

1.4	66	11/10 →	1.396	B	M	4	16	G4FA		84015	<b>NEW</b>
1.6	92	11/10 →	1.591	B	M	4	16	G4FC		84015	<b>NEW</b>

**ix 35**

1.6	99	11/10 →	1.591	B	M	4	16	G4FD		84015	<b>NEW</b>
-----	----	---------	-------	---	---	---	----	------	--	-------	------------



--	--	--	--	--	--	--	--	--	--

## HYUNDAI

### Lantra I

1.5 i.e.	63	10/90 → 11/95	1.468	B	M	4	8	G15B, G4DJ	81784
1.6 i.e. 16V	78	10/90 → 11/95	1.596	B	M	4	16	G4CR	81785
	84	10/90 → 11/95	1.596	B	M	4	16	G4CR	81785
1.8 i.e. 16V	93	10/90 → 11/95	1.836	B	M	4	16	G4CN	81786

### Lantra II, Station Wagon

1.5 12V	65	12/96 → 09/00	1.495	B	M	4	12	G4EK	81784
1.6 16V	84	11/95 → 09/00	1.599	B	M	4	16	4G61	81785
1.6 i	66	11/95 → 09/00	1.599	B	M	4	16	G4GR	81785
1.8 16V	94	11/95 → 09/00	1.795	B	M	4	16	G4GM	81785
1.9 D	50	03/98 → 09/00	1.905	D	M	4	8	DJY	81642
2.0 16V	102	08/96 → 09/00	1.975	B	M	4	16	G4GF	81785

### Matrix

1.5 CRDi	75	12/04 → 08/10	1.493	D	M	4	16	D4FA	84058	
	60	10/01 → 08/10	1.496	D	M	3	12	D3EA	82085	
1.5 CRDi VGT	81	08/05 → 08/10	1.493	D	M	4	16	D4FA	84058	
1.6	66	01/02 → 12/05	1.599	B	M	4	16	G4ED-L	82020	
	76	06/01 → 08/10	1.599	B	AM	4	16	G4ED-G	82020	
1.8	90	06/01 → 08/10	1.795	B	M	4	16	G4GB-G	81785	

### Pony III / Excel

1.3	43	10/89 → 01/95	1.299	B	M	4	8	G4DG	81784
	49	10/89 → 01/95	1.299	B	M	4	8	G4DG	81784
1.5	53	10/89 → 01/95	1.468	B	M	4	8	G15B, G4DJ	81784
1.5 i	61	10/89 → 01/95	1.468	B	M	4	8	G15B, G4DJ	81784
	62	10/89 → 01/95	1.468	B	M	4	8	G15B, G4DJ	81784

### S Coupé

1.5 GS	57	03/90 → 12/92	1.468	B	M	4	8	G4DJ	81784
1.5 i	62	02/90 → 05/96	1.468	B	M	4	8	G15B, G4DJ	81784
	65	04/92 → 05/96	1.495	B	M	4	12	G4EK	81784
1.5 i Turbo	85	04/91 → 05/96	1.495	B	M	4	12	G4EK-TC	81784

### Santa Fé I

2.0 CRDi	83	08/01 → 03/06	1.991	D	M	4	16	D4EA	82085	
2.0 CRDi 4x4	83	04/01 → 03/06	1.991	D	AM	4	16	D4EA	82085	
	92	08/03 → 03/06	1.991	D	M	4	16	D4EA	82085	
2.0 CRDi Trazione integrale	107	11/03 → 02/06	1.991	D	M	4	16	D4EA	82085	
2.2 CRDi	110	10/05 → 03/06	2.188	D	M	4	16	D4EB	84059	
2.7 V6 4x4	127	02/01 → 03/06	2.656	B	A	6	24	G6BA-G	82021	

### Santa Fé II

2.2 CRDi	102	03/06 →	2.188	D	M	4	16	D4EB	84059	
	114	03/06 →	2.188	D	M	4	16	D4EB	84059	
	145	01/09 →	2.199	D	M	4	16	D4HB	84059	

**KW**

**cm<sup>3</sup>**

**NO. OF VALVES**

**MAGNETI MARELLI**
**HYUNDAI**
**Santa Fé II**

2.2 CRDi 4x4	102	03/06 →	2.188	D	M	4	16	D4EB		84059	<b>NEW</b>
	110	10/05 → 03/06	2.188	D	M	4	16	D4EB		84059	<b>NEW</b>
	114	03/06 →	2.188	D	M	4	16	D4EB		84059	<b>NEW</b>
	145	01/09 →	2.199	D	M	4	16	D4HB		84059	<b>NEW</b>
2.2 CRDi GLS	110	03/06 →	2.188	D	M	4	16	D4EB		84059	<b>NEW</b>
2.2 CRDi GLS 4x4	110	03/06 →	2.188	D	M	4	16	D4EB		84059	<b>NEW</b>

**Sonata II**

2.0 i 16V	96	01/91 → 10/93	1.997	B	M	4	16	G4CP-D		81786	
-----------	----	---------------	-------	---	---	---	----	--------	--	-------	--

**Sonata III**

2.0 i 16V	92	06/96 → 06/98	1.997	B	M	4	16	G4CP-DM		81786	
	102	05/93 → 06/98	1.997	B	M	4	16	G4CP-D		81786	

**Sonata IV**

2.5 V6 24V	118	06/98 → 10/01	2.493	B	A	6	24	G6BV-G		82021	
2.7 V6	127	10/01 → 11/04	2.656	B	AM	6	24	G6BA-G		82021	
	129	11/02 → 11/04	2.656	B	M	6	24	G6BA		82021	

**Sonata V**

2.0 CRDi	100	02/06 → 12/10	1.991	D	M	4	16	D4EA		84059	<b>NEW</b>
	103	02/06 → 12/10	1.991	D	M	4	16	D4EA		84059	<b>NEW</b>
	110	03/09 → 12/10	1.991	D	M	4	16	D4EA		84059	<b>NEW</b>

**Starex**

2.5 D	57	10/97 → 04/04	2.476	D	M	4	8	D4BF		81787	
2.5 TD	59	06/97 → 04/04	2.476	D	M	4	8	D4BF		81787	
2.5 TD 4WD	59	02/98 → 04/04	2.476	D	M	4	8	D4BF		81787	

**Tiburon**

1.6 CVVT	78	10/06 → 12/08	1.599	B	M	4	16	G4ED-G		82020	
2.0 CVVT	105	10/06 → 12/08	1.975	B	M	4	16	G4GC		81785	

**Trajjet**

2.0	103	01/04 → 07/08	1.975	B	M	4	16	G4GC-G		81785	
	104	11/03 → 07/08	1.975	B	M	4	16	G4GC	02-2004 →	81785	
2.0 CRDi	83	04/01 → 07/08	1.991	D	AM	4	16	D4EA		82085	
	92	08/05 → 07/08	1.991	D	M	4	16	D4EA		82085	
2.7 V6	127	09/00 → 07/08	2.656	B	A	6	24	G6BA-G		82021	

**Tucson I**

2.0	104	08/04 → 03/10	1.975	B	M	4	16	G4GC		81785	
2.0 CRDi	83	08/04 → 03/10	1.991	D	M	4	16	D4EA	→ 12-2005	82085	
	83	08/04 → 03/10	1.991	D	M	4	16	D4EA	01-2006 →	84059	<b>NEW</b>
	88	01/07 → 03/10	1.991	D	M	4	16	D4EA		84059	<b>NEW</b>
	100	01/06 → 03/10	1.991	D	M	4	16	D4EA		84059	<b>NEW</b>
	103	01/06 → 03/10	1.991	D	M	4	16	D4EA-V		84059	<b>NEW</b>
	110	01/09 → 03/10	1.991	D	M	4	16	D4EA		84059	<b>NEW</b>

**KW**

**cm<sup>3</sup>**

**NO. OF VALVES**

## HYUNDAI

### Tucson I

2.0 CRDi Trazione integrale	83	08/04 → 03/10	1.991	D	M	4	16	D4EA	→ 12-2005	82085	
	83	08/04 → 03/10	1.991	D	M	4	16	D4EA	01-2006 →	84059	<b>NEW</b>
	88	01/07 → 03/10	1.991	D	M	4	16	D4EA		84059	<b>NEW</b>
	100	01/06 → 03/10	1.991	D	M	4	16	D4EA		84059	<b>NEW</b>
	103	01/06 → 03/10	1.991	D	M	4	16	D4EA-F, D4EA-V		84059	<b>NEW</b>
	110	01/09 → 03/10	1.991	D	M	4	16	D4EA		84059	<b>NEW</b>
2.0 Trazione integrale	104	08/04 → 03/10	1.975	B	M	4	16	G4GC		81785	
2.7 Trazione integrale	129	08/04 → 03/10	2.656	B	M	6	24	G6BA-G		82021	

### Tucson III

1.6 GDi	97	06/15 →	1.591	B	M	4	16	G4FD		84015	<b>NEW</b>
1.6 T-GDI	130	06/15 →	1.591	B	M	4	16	G4FJ		84015	<b>NEW</b>
1.6 T-GDI Trazione integrale	130	06/15 →	1.591	B	M	4	16	G4FJ		84015	<b>NEW</b>

### Velostar

1.6 GDI	103	03/11 →	1.591	B	M	4	16	G4FD		84015	<b>NEW</b>
1.6 T-GDI	137	10/12 →	1.591	B	M	4	16	G4FJ		84015	<b>NEW</b>

### XG

250	120	12/98 → 12/05	2.493	B	M	6	24	G6AV		82021	
-----	-----	---------------	-------	---	---	---	----	------	--	-------	--

## INFINITI

### Q30

1.5 D	80	11/15 →	1.461	D	M	4	8			82098	
-------	----	---------	-------	---	---	---	---	--	--	-------	--

## INNOCENTI

### Elba

1.3	49	08/91 → 12/96	1.301	B	M	4	8	146A5.000		81434	
1.4 i.e.	49	09/94 → 12/96	1.372	B	M	4	8	146C5.000, 146D5.000	(-)COP, → 02-1995	81314	
	49	09/94 → 12/96	1.372	B	M	4	8	146C5.000, 146D5.000	(-)COP, 03-1995 →	81366	
	49	09/94 → 12/96	1.372	B	M	4	8	146C5.000, 146D5.000	(+)COP, → 02-1995	81476	
	49	09/94 → 12/96	1.372	B	M	4	8	146C5.000, 146D5.000	(+)COP, 03-1995 →	81343	
1.6 i.e.	55	09/94 → 12/96	1.580	B	M	4	8	146C6.000, 146D6.000	(-)COP	81314	
	55	09/94 → 12/96	1.580	B	M	4	8	146C6.000, 146D6.000	(+)COP	81476	
1.7 D	42	08/91 → 12/96	1.697	D	M	4	8	146B2.000	(+)COP, (-)SS, (-)AC	81456	
	42	08/91 → 12/96	1.697	D	M	4	8	146B2.000	(+)SS, (+)AC	81344	

### Koral

55	40	01/90 → 12/92	1.116	B	M	4	8	146A6.000	(-)COP	81481	
----	----	---------------	-------	---	---	---	---	-----------	--------	-------	--

### Mini

1.0	27	10/85 → 10/91	999	B	M	4	8	99H	BC	81419	
-----	----	---------------	-----	---	---	---	---	-----	----	-------	--

**KW**

**cm<sup>3</sup>**

**NO. OF VALVES**

**IVECO**
**Daily II**

30-10	76	01/97 → 05/99	2.798	D	M	4	8	8140.23.		81332
30-10 C	76	01/97 → 05/99	2.798	D	M	4	8	8140.23.		81332
30-8	55	01/92 → 08/98	2.499	D	M	4	8	8140.07.2700	→ 12-1995	81334
	55	01/92 → 08/98	2.499	D	M	4	8	8140.07.2700	01-1996 →	81332
	55	01/89 → 08/98	2.499	D	M	4	8	8140.07.2700, 8140.07.2712		81332
	60	01/92 → 08/98	2.499	D	M	4	8	8140.67F.	→ 12-1995	81334
	60	01/89 → 08/98	2.499	D	M	4	8	8140.67F., 8140.67F.3710, 8140.67F.3711, 8140.67F.3713, 8140.67F.3721		81332
	60	01/92 → 08/98	2.499	D	M	4	8	8140.67F., 8140.67F.3710, 8140.67F.3711, 8140.67F.3713, 8140.67F.3721	01-1996 →	81332
	62	09/98 → 05/99	2.798	D	M	4	8	8140.63.		81332
30-8 V	62	09/98 → 05/99	2.798	D	M	4	8	8140.63.		81332
35-10	68	01/89 → 12/96	2.499	D	M	4	8	8140.97.2781	→ 12-1990	81491
	68	01/89 → 12/96	2.499	D	M	4	8	8140.97.2781	01-1991 →, → 12-1995	81334
	76	01/89 → 12/96	2.499	D	M	4	8	8140.47R.2790	→ 12-1990	81491
	76	01/89 → 12/96	2.499	D	M	4	8	8140.47R.2790	01-1991 →, → 12-1995	81334
	76	01/96 → 05/99	2.798	D	M	4	8	8140.23.		81332
35-10 K	76	01/97 → 05/99	2.798	D	M	4	8	8140.23.		81332
35-12	90	05/96 → 05/99	2.798	D	M	4	8	8140.43.		81332
35-12 K	90	09/96 → 08/98	2.798	D	M	4	8	8140.43.		81332
35-8	62	09/98 → 05/99	2.798	D	M	4	8	8140.63.		81332
35-8 K	62	09/98 → 05/99	2.798	D	M	4	8	8140.63.		81332
40-10 V	76	01/90 → 04/96	2.499	D	M	4	8	8140.27.2720		81334
45-10	76	01/89 → 04/96	2.499	D	M	4	8	8140.27.2720		81334
45-10 V	76	01/89 → 04/96	2.499	D	M	4	8	8140.27.2720		81334
49-10	76	01/89 → 04/96	2.499	D	M	4	8	8140.27.2700, 8140.47R.2790		81334
	76	05/96 → 05/99	2.798	D	M	4	8	8140.23.		81332
49-10 K	76	01/89 → 04/96	2.499	D	M	4	8	8140.27.2700, 8140.47R.2790		81334
	76	05/96 → 05/99	2.798	D	M	4	8	8140.23.		81332
49-10 V	76	01/89 → 04/96	2.499	D	M	4	8	8140.27.2700, 8140.47R.2790		81334
49-12	90	05/96 → 05/99	2.798	D	M	4	8	8140.43.		81332
49-12 K	90	05/96 → 05/99	2.798	D	M	4	8	8140.43.		81332
49-12 V	90	05/96 → 05/99	2.798	D	M	4	8	8140.43.		81332
59-12 K	90	05/96 → 05/99	2.798	D	M	4	8	8140.43.		81332

**KW**

**cm<sup>3</sup>**

**NO. OF VALVES**

**IVECO**
**Daily II**

59-12 V	90	05/96 → 05/99	2.798	D	M	4	8	8140.43.		81332
A 40-10	76	01/91 → 12/96	2.499	D	M	4	8	8140.27.2720		81334
A 45-10	76	01/91 → 04/96	2.499	D	M	4	8	8140.27.2720		81334

**Daily III**

29 L 12	85	09/02 → 04/06	2.287	D	M	4	16	F1AE0481B		82024
29 L 12 V	85	09/02 → 07/07	2.287	D	M	4	16	F1AE0481B		82024
35 C 14	100	09/04 → 04/06	2.998	D	M	4	16	F1CE0481A		82095
35 C 14, 35 S 14	100	01/05 → 04/06	2.287	D	M	4	16	F1AE0481M		82095
35 C 17, 35 S 17	122	01/05 → 04/06	2.998	D	M	4	16	F1CE0481B		82095
40 C 14	100	09/04 → 04/06	2.998	D	M	4	16	F1CE0481A		82095
40 C 17, 40 S 17	122	01/05 → 04/06	2.998	D	M	4	16	F1CE0481B		82095
50 C 14	100	09/04 → 04/06	2.998	D	M	4	16	F1CE0481A		82095
50 C 17	122	09/04 → 04/06	2.998	D	M	4	16	F1CE0481B		82095
65 C 14	100	09/04 → 04/06	2.998	D	M	4	16	F1CE0481A		82095
65 C 17	122	09/04 → 04/06	2.998	D	M	4	16	F1CE0481B		82095

**Daily IV**

35C15	107	05/06 → 08/11	2.998	D	M	4	16	F1CE0481FA		82095
35C15 V, 35C15 V/P	107	05/06 → 08/11	2.998	D	M	4	16	F1CE0481FA		82095
35C18	130	05/06 → 08/11	2.998	D	M	4	16	F1CE0481HA		82095
35C18 V, 35C18 V/P, 35S18 V, 35S18 V/P	130	05/06 → 08/11	2.998	D	M	4	16	F1CE0481HA		82095
35C18, 35S18	130	05/06 → 08/11	2.998	D	M	4	16	F1CE0481HA		82095
40C15	107	05/06 → 08/11	2.998	D	M	4	16	F1CE0481FA		82095
40C15 V, 40C15 V/P	107	05/06 → 08/11	2.998	D	M	4	16	F1CE0481FA		82095
40C18	130	05/06 → 08/11	2.998	D	M	4	16	F1CE0481HA		82095
40C18 V, 40C18 V/P	130	05/06 → 08/11	2.998	D	M	4	16	F1CE0481HA		82095
45C15	107	05/06 → 08/11	2.998	D	M	4	16	F1CE0481FA		82095
45C15 V	107	05/06 → 08/11	2.998	D	M	4	16	F1CE0481FA		82095
45C18	130	05/06 → 08/11	2.998	D	M	4	16	F1CE0481HA		82095
45C18, 45C18 /P, 45C18 D, 45C18 D/P	130	05/06 → 08/11	2.998	D	M	4	16	F1CE0481HA		82095
50C15	107	05/06 → 08/11	2.998	D	M	4	16	F1CE0481FA		82095
50C15 V, 50C15 V/P	107	05/06 → 08/11	2.998	D	M	4	16	F1CE0481FA		82095
50C18	130	05/06 → 08/11	2.998	D	M	4	16	F1CE0481HA		82095
50C18 V, 50C18 V/P	130	05/06 → 08/11	2.998	D	M	4	16	F1CE0481HA		82095
60C15	107	05/06 → 08/11	2.998	D	M	4	16	F1CE0481FA		82095
60C15 V	107	05/06 → 08/11	2.998	D	M	4	16	F1CE0481FA		82095
60C15, 60C15 /P, 60C15 D, 60C15 D/P	107	05/06 → 08/11	2.998	D	M	4	16	F1CE0481FA		82095
60C18	130	05/06 → 08/11	2.998	D	M	4	16	F1CE0481HC		82095
65C15	107	05/06 → 08/11	2.998	D	M	4	16	F1CE0481FA		82095
65C15, 65C15 /P, 65C15 D, 65C15 D/P	107	05/06 → 08/11	2.998	D	M	4	16	F1CE0481FA		82095
65C18	130	05/06 → 08/11	2.998	D	M	4	16	F1CE0481HC		82095

**KW**

**cm<sup>3</sup>**

**NO. OF  
VALVES**

**MAGNETI  
MARELLI**
**JAGUAR**
**X Type, Estate**

2.0 D	96	07/03 → 11/09	1.998	D	M	4	16	FMBA, FMBB, R4-X404		81805
2.0 V6	115	03/02 → 10/05	2.099	B	M	6	24			81845
2.2 D	107	01/07 → 11/09	2.198	D	M	4	16	LJ46G		81805
	114	10/05 → 11/09	2.198	D	M	4	16	LJ46G		81805
2.5	144	02/04 → 12/09	2.495	B	M	6	24			81845
2.5 V6 Trazione integrale	144	06/01 → 11/09	2.495	B	M	6	24			81845
3.0	169	02/04 → 12/09	2.967	B	M	6	24	AJ-V6		81845
3.0 V6 Trazione integrale	169	06/01 → 11/07	2.967	B	M	6	24	AJ-V6		81845

**XF I**

2.2 D	120	04/11 → 04/15	2.179	D	M	4	16	224DT		82068
	140	05/11 → 04/15	2.179	D	M	4	16	224DT		82068
	147	03/12 → 04/15	2.179	D	M	4	16	224DT		82068

**XF II, Sportbrake**

2.2 D	120	09/12 → 04/14	2.179	D	M	4	16	224DT		82068
	147	09/12 → 04/14	2.179	D	M	4	16	224DT		82068

**JEEP**
**Cherokee II (XJ)**

2.5	89	10/95 → 09/01	2.469	B	M	4	8	EPE	(-)COP	81362
2.5 TD	85	01/88 → 09/01	2.499	D	M	4	8	ENC	(-)COP	81362

**Cherokee III (KJ)**

2.5 CRD 4x4	105	09/01 → 01/08	2.499	D	M	4	16	R425DOHC		84035 <b>NEW</b>
2.8 CRD 4x4	110	11/02 → 01/08	2.776	D	M	4	16	ENR		84035 <b>NEW</b>
	120	11/04 → 01/08	2.776	D	M	4	16	ENR		84035 <b>NEW</b>

**Cherokee IV (KK)**

2.8 CRD 4x4	130	05/08 →	2.777	D	M	4	16	ENS		84035 <b>NEW</b>
2.8 CRDi 4x4	147	01/10 →	2.777	D	M	4	16	ENS		84043 <b>NEW</b>

**Commander**

3.0 CRD 4x4	160	04/06 → 12/10	2.987	D	M	6	24	EXL		82058
-------------	-----	---------------	-------	---	---	---	----	-----	--	-------

**Compass**

2.0 CRD	103	08/06 →	1.968	D	M	4	16	ECD, ECE		81816
	103	08/06 →	1.968	D	M	4	16	ECD, ECE		84011 <b>NEW</b>
2.0 CRD 4x4	103	09/06 →	1.968	D	M	4	16	ECE		81816
	103	09/06 →	1.968	D	M	4	16	ECE		84011 <b>NEW</b>

**Grand Cherokee I**

2.5 TD 4x4	85	10/95 → 04/99	2.499	D	M	4	8	M51, M52	(-)COP	81362
2.5 TD Laredo	85	10/96 → 09/98	2.498	D	M	4	8		(-)COP	81362

**Grand Cherokee II**

3.1 TD 4x4	103	04/99 → 12/01	3.125	D	M	5	10	EXA	(-)COP	81362
------------	-----	---------------	-------	---	---	---	----	-----	--------	-------

**Grand Cherokee III**

3.0 CRD 4x4	155	05/06 → 12/10	2.987	D	M	6	24	EXL		82058
	160	06/05 → 12/10	2.987	D	M	6	24	EXL		82058

--	--	--	--	--	--	--	--	--	--

## JEEP

### Patriot

2.0 CRD	103	02/07 →	1.968	D	M	4	16	ECD, ECE		81816
	103	02/07 →	1.968	D	M	4	16	ECD, ECE		84011 <b>NEW</b>
2.0 CRD 4x4	103	02/07 →	1.968	D	M	4	16	ECD, ECE		81816
	103	02/07 →	1.968	D	M	4	16	ECD, ECE		84011 <b>NEW</b>

### Renegade

1.4	103	07/14 →	1.368	B	M	4	16	EAM	TESMA	82070
1.4 4x4	125	07/14 →	1.368	B	M	4	16	EAM	TESMA	82070
1.6	81	07/14 →	1.598	B	M	4	16	EJH		81861
1.6 CRD	88	07/14 →	1.598	D	M	4	16	EJK		81872
2.0 CRD 4x4	88	07/14 →	1.956	D	M	4	16	EBT		81872
	103	07/14 →	1.956	D	M	4	16	EBT		81872
	125	07/14 →	1.956	D	M	4	16	EBT		81872

### Wrangler II

2.4	105	11/02 → 04/07	2.429	B	M	4	16	ED1	(-)COP	81365
	105	11/02 → 04/07	2.429	B	M	4	16	ED1	(+)COP	81304
2.8 CRDi	130	11/06 → 04/07	2.776	D	M	4	16	ENS		84035 <b>NEW</b>

### Wrangler III

2.8 CRD	147	11/10 →	2.776	D	M	4	16	ENS		84043 <b>NEW</b>
	130	04/07 →	2.777	D	M	4	16	ENS		84043 <b>NEW</b>

## KIA

### Carens II

2.0 CRDi	83	07/02 →	1.991	D	M	4	16	D4EA		82085
	103	11/05 →	1.991	D	M	4	16	D4EA		84059 <b>NEW</b>
2.0 CVT	102	08/04 →	1.975	B	M	4	16	G4GC		81785

### Carens III

1.6 CVT	93	10/10 →	1.591	B	M	4	16	G4FC		84015 <b>NEW</b>
	97	08/09 →	1.591	B	M	4	16	G4FC		84015 <b>NEW</b>
2.0 CRDi 115	85	05/07 →	1.991	D	M	4	16	D4EA		84059 <b>NEW</b>
2.0 CRDi 135	100	08/09 →	1.991	D	M	4	16	D4EA		84059 <b>NEW</b>
2.0 CRDi 140	103	09/06 →	1.991	D	M	4	16	D4EA		84059 <b>NEW</b>

### Carens IV

1.6 GDi	99	03/13 →	1.591	B	M	4	16	G4FD		84015 <b>NEW</b>
2.0 GDi	122	03/13 →	1.999	B	M	4	16	G4NC		84064 <b>NEW</b>
	130	03/13 →	1.999	B	M	4	16	G4NC		84064 <b>NEW</b>

### Carnival I

2.9 TD	93	08/99 → 10/01	2.903	D	M	4	16	J3		82038
--------	----	---------------	-------	---	---	---	----	----	--	-------

### Carnival II

2.9 TD	93	01/99 →	2.903	D	M	4	16	J3		82038
--------	----	---------	-------	---	---	---	----	----	--	-------

### Cee'd I, Station Wagon

1.4	77	12/06 → 12/12	1.396	B	M	4	16	G4FA		84015 <b>NEW</b>
	80	12/06 → 12/12	1.396	B	M	4	16	G4FA		84015 <b>NEW</b>
1.4 CVT	66	06/10 → 12/12	1.396	B	M	4	16	G4FA-L		84015 <b>NEW</b>

**KW**

**cm<sup>3</sup>**

**NO. OF VALVES**

**MAGNETI MARELLI**
**KIA**
**Cee'd I, Station Wagon**

1.6	85	09/07 → 12/12	1.591	B	M	4	16	G4FC		84015	<b>NEW</b>
	90	12/06 → 12/12	1.591	B	M	4	16	G4FC		84015	<b>NEW</b>
	93	02/08 → 12/12	1.591	B	M	4	16	G4FC		84015	<b>NEW</b>
1.6 CRDi 115	85	12/06 → 12/12	1.582	D	M	4	16	D4FB		84058	<b>NEW</b>
1.6 CRDi 90	66	12/06 → 12/12	1.582	D	M	4	16	D4FB-L		84058	<b>NEW</b>
1.6 CVVT	92	10/10 → 12/12	1.591	B	M	4	16	G4FC		84015	<b>NEW</b>
2.0	105	12/06 → 12/12	1.975	B	M	4	16	G4GC		81785	
2.0 CRDi	100	06/07 → 12/12	1.991	D	M	4	16	D4EA		84059	<b>NEW</b>
2.0 CRDi 140	103	09/07 → 12/12	1.991	D	M	4	16	D4EA-F		82085	

**Cee'd II, Station Wagon**

1.4 CRDi 90	66	05/12 →	1.396	D	M	4	16	D4FC		84063	<b>NEW</b>
1.4 CVVT	66	05/12 →	1.396	B	M	4	16	G4FA-L		84015	<b>NEW</b>
	73	05/12 →	1.396	B	M	4	16	G4FA		84015	<b>NEW</b>
1.6 CRDi 110	81	05/12 →	1.582	D	M	4	16	D4FB		84063	<b>NEW</b>
1.6 CRDi 128	94	05/12 →	1.582	D	M	4	16	D4FB		84063	<b>NEW</b>
1.6 CVVT	92	05/12 →	1.591	B	M	4	16	G4FC		84015	<b>NEW</b>
1.6 GDI	99	05/12 →	1.591	B	M	4	16	G4FD		84015	<b>NEW</b>
1.6 GT	150	06/13 →	1.591	B	M	4	16	G4FJ		84015	<b>NEW</b>

**Cerato I**

1.5 CRDi	75	07/05 →	1.493	D	M	4	16	D4FA		84058	<b>NEW</b>
1.6	90	05/06 →	1.591	B	M	4	16	G4FC		84015	<b>NEW</b>
	90	05/06 →	1.591	B	M	4	16	G4FC		82020	
	77	07/04 →	1.599	B	M	4	16	G4ED		82020	
1.6 CRDi	85	06/05 →	1.582	D	M	4	16	D4FB		84058	<b>NEW</b>
2.0	105	04/04 →	1.975	B	M	4	16	G4GC		81785	
2.0 CRDi	83	04/04 →	1.991	D	M	4	16	D4EA	→ 05-2005	82085	
	83	04/04 →	1.991	D	M	4	16	D4EA	06-2005 →	84059	<b>NEW</b>

**Cerato II**

1.6	93	01/10 →	1.591	B	M	4	16	G4FC		84015	<b>NEW</b>
1.6 CVVT	91	02/09 →	1.591	B	M	4	16	G4FC		84015	<b>NEW</b>
1.6 MPi	96	06/13 →	1.591	B	M	4	16	G4FC		84015	<b>NEW</b>

**Joice**

2.0	88	09/01 →	1.997	B	M	4	16	G4CP		81786	
	102	02/00 →	1.997	B	M	4	16	G4CP		81786	

**Magentis I**

2.5 V6	124	05/01 →	2.493	B	A	6	24	G6BV		82021	
--------	-----	---------	-------	---	---	---	----	------	--	-------	--

**Magentis II**

2.0 CRDi	100	11/05 → 12/08	1.991	D	M	4	16	D4EA		84059	<b>NEW</b>
	103	04/06 →	1.991	D	M	4	16	D4EA		84059	<b>NEW</b>
	110	04/06 →	1.991	D	M	4	16	D4EA		84059	<b>NEW</b>



**KW**

**cm<sup>3</sup>**

**NO. OF VALVES**

**MAGNETI  
MARELLI**
**KIA**
**Picanto I**

1.0	45	04/04 →	999	B	M	4	12	G4HE		84018	<b>NEW</b>
	46	11/09 →	999	B	M	4	12	G4HE		84018	<b>NEW</b>
1.1	48	04/04 →	1.086	B	M	4	12	G4HG		84018	<b>NEW</b>
1.1 CRDi	55	11/05 →	1.120	D	M	3	12	D3FA		84058	<b>NEW</b>

**Picanto II**

1.2	63	09/11 →	1.248	B	M	4	16	G4LA		84040	<b>NEW</b>
-----	----	---------	-------	---	---	---	----	------	--	-------	------------

**Pride I, Van**

1.5 CRDi LX	81	03/05 →	1.493	D	M	4	16	D4FA		84058	<b>NEW</b>
1.6 CVT LX	82	03/05 →	1.599	B	M	4	16	G4ED		82020	

**Pro Cee'd I**

1.4	77	02/08 → 09/12	1.396	B	M	4	16	G4FA		84015	<b>NEW</b>
	80	02/08 → 09/12	1.396	B	M	4	16	G4FA		84015	<b>NEW</b>
1.4 CVT	66	06/10 → 09/12	1.396	B	M	4	16	G4FA-L		84015	<b>NEW</b>
1.6	90	02/08 → 09/12	1.591	B	M	4	16	G4FC		84015	<b>NEW</b>
	93	02/08 → 09/12	1.591	B	M	4	16	G4FC		84015	<b>NEW</b>
1.6 CRDi 115	85	02/08 → 09/12	1.582	D	M	4	16	D4FB		84058	<b>NEW</b>
1.6 CRDi 90	66	02/08 → 09/12	1.582	D	M	4	16	D4FB-L		84058	<b>NEW</b>
1.6 CVT	92	10/10 → 02/13	1.591	B	M	4	16	G4FC		84015	<b>NEW</b>
2.0	105	02/08 → 09/12	1.975	B	M	4	16	G4GC		81785	
2.0 CRDi 140	103	02/08 → 09/12	1.991	D	M	4	16	D4EA-F		84059	<b>NEW</b>
2.0 LPG	105	01/09 → 12/09	1.975		M	4	16	G4GC		81785	

**Pro Cee'd II**

1.4 CRDi 90	66	03/13 →	1.396	D	M	4	16	D4FC		84063	<b>NEW</b>
1.4 CVT	73	03/13 →	1.396	B	M	4	16	G4FA		84015	<b>NEW</b>
1.6 CRDi 110	81	03/13 →	1.582	D	M	4	16	D4FB		84063	<b>NEW</b>
1.6 CRDi 128	94	03/13 →	1.582	D	M	4	16	D4FB		84063	<b>NEW</b>
1.6 GDI	99	03/13 →	1.591	B	M	4	16	G4FD		84015	<b>NEW</b>
1.6 GT	150	06/13 →	1.591	B	M	4	16	G4FJ		84015	<b>NEW</b>

**Rio II**

1.4 16V	71	03/05 →	1.399	B	M	4	16	G4EE		82020	
1.5 CRDi	65	06/08 →	1.493	D	M	4	16	D4FA		84063	<b>NEW</b>
	81	03/05 →	1.493	D	M	4	16	D4FA	→ 04-2008	84058	<b>NEW</b>
1.6 16V	82	03/05 →	1.599	B	M	4	16	G4ED		82020	
1.6 CVT	82	03/05 →	1.599	B	M	4	16	G4ED		82020	

**Rio III**

1.1 CRDi	55	09/11 →	1.120	D	M	3	12	D3FA		84063	<b>NEW</b>
1.2 CVT	62	11/14 →	1.248	B	M	4	16	G4LA		84040	<b>NEW</b>
1.25 CVT	63	09/11 →	1.248	B	M	4	16	G4LA		84040	<b>NEW</b>
1.25 LPG	63	09/11 →	1.248		M	4	16	G4LA		84040	<b>NEW</b>
1.4 CRDi	66	09/11 →	1.396	D	M	4	16	D4FC		84063	<b>NEW</b>
1.4 CVT	79	09/11 →	1.396	B	M	4	16	G4FA		84015	<b>NEW</b>
	80	09/11 →	1.396	B	M	4	16	G4FA		84015	<b>NEW</b>
1.6 CVT	90	06/12 →	1.591	B	M	4	16	G4FC		84015	<b>NEW</b>

**KW**

**cm<sup>3</sup>**

**NO. OF  
VALVES**

**MAGNETI  
MARELLI**
**KIA**
**Soul I**

1.6	91	09/09 → 12/10	1.591	B	M	4	16	G4FG		84015	<b>NEW</b>
1.6 CVT	77	02/09 →	1.591	B	M	4	16	G4FC		84015	<b>NEW</b>
	93	02/09 →	1.591	B	M	4	16	G4FC		84015	<b>NEW</b>
	95	03/12 →	1.591	B	M	4	16	G4FC		84015	<b>NEW</b>
1.6 GDI	103	06/11 →	1.591	B	M	4	16	G4FD		84015	<b>NEW</b>

**Soul II**

1.6 GDI	97	02/14 →	1.591	B	M	4	16	G4FD		84015	<b>NEW</b>
---------	----	---------	-------	---	---	---	----	------	--	-------	------------

**Sportage II**

2.0 16V 4WD	104	09/04 →	1.975	B	M	4	16	G4GC		81785	
2.0 CRDi	83	02/05 →	1.991	D	M	4	16	D4EA		82085	
	83	02/05 →	1.991	D	M	4	16	D4EA		84059	<b>NEW</b>
	100	01/06 →	1.991	D	M	4	16	D4EA		84059	<b>NEW</b>
	103	01/06 →	1.991	D	M	4	16	D4EA-V		82085	
	103	01/06 →	1.991	D	M	4	16	D4EA-V		84059	<b>NEW</b>
	110	09/08 →	1.991	D	M	4	16	D4EA		84059	<b>NEW</b>
2.0 CRDi 4WD	83	09/04 →	1.991	D	M	4	16	D4EA		82085	
	83	09/04 →	1.991	D	M	4	16	D4EA		84059	<b>NEW</b>
	100	01/06 →	1.991	D	M	4	16	D4EA		84059	<b>NEW</b>
	103	01/06 →	1.991	D	M	4	16	D4EA-F, D4EA-V		82085	
	103	01/06 →	1.991	D	M	4	16	D4EA-F, D4EA-V		84059	<b>NEW</b>
	110	09/08 →	1.991	D	M	4	16	D4EA		84059	<b>NEW</b>
2.0 i 16V	104	09/04 →	1.975	B	M	4	16	G4GC		81785	
2.7 V6 4WD	129	09/04 →	2.656	B	M	6	24	G6BA		82021	

**Sportage III**

1.6 GDI	97	09/15 →	1.591	B	M	4	16	G4FD		84015	<b>NEW</b>
	99	02/11 →	1.591	B	M	4	16	G4FD		84015	<b>NEW</b>
	130	09/15 →	1.591	B	M	4	16	G4FJ		84015	<b>NEW</b>
1.6 GDI 4WD	130	09/15 →	1.591	B	M	4	16	G4FJ		84015	<b>NEW</b>
2.0 CVT	120	07/10 →	1.998	B	M	4	16	G4KD		84064	<b>NEW</b>
	122	07/10 →	1.998	B	M	4	16	G4KD		84064	<b>NEW</b>
2.0 CVT AWD	120	07/10 →	1.998	B	M	4	16	G4KD		84064	<b>NEW</b>
2.0 GDI	122	02/14 →	1.998	B	M	4	16	G4NC		84064	<b>NEW</b>
2.0 GDI AWD	122	02/14 →	1.998	B	M	4	16	G4NC		84064	<b>NEW</b>

**Venga**

1.4 CVT	66	02/10 →	1.396	B	M	4	16	G4FA-L		84015	<b>NEW</b>
1.6 CVT	92	02/10 →	1.591	B	M	4	16	G4FC		84015	<b>NEW</b>

**LADA**
**110**

1.5	54	01/95 →	1.499	B	M	4	8	BA32111		81717	
	56	10/00 →	1.499	B	M	4	8	VAZ-2111		81717	
	57	01/95 →	1.499	B	M	4	8	VAZ-2111		81717	
2.0 i	110	08/96 →	1.998	B	M	4	16	C20XE		81550	

**KW**

**cm<sup>3</sup>**

**NO. OF VALVES**

**LADA**
**Niva I**

1600	54	01/87 → 03/95	1.569	B	M	4	8	BA32121		81999
1700 i	59	06/96 →	1.690	B	M	4	8	BA321214		81999
1700 i 4x4	60	10/00 →	1.690	B	M	4	8	BA321214		81999
1900 Diesel	47	01/93 →	1.905	D	M	4	8	XUD9A		81672
	55	01/99 →	1.905	D	M	4	8	XUD9SD		81672

**Nova**

1300	48	09/85 → 12/91	1.294	B	M	4	8	BA32105		81999
1500	49	08/94 →	1.451	B	M	4	8	BA32103		81999
	55	09/85 → 02/93	1.458	B	M	4	8	BA32103		81999
1600	56	01/88 → 10/01	1.570	B	M	4	8	BA32106		81999
1700	62	08/94 →	1.690	B	M	4	8	B032123		81999
1700 i Classic	62	06/96 →	1.690	B	M	4	8	B032123		81999

**Samara**

1.5	57	04/96 →	1.499	B	M	4	8	VAZ-2111		81717
1100	43	02/96 →	1.099	B	M	4	8	BA321081		81717
	39	02/88 → 12/94	1.100	B	M	4	8	BA321081	→ 02-1992	81619
	39	02/88 → 12/94	1.100	B	M	4	8	BA321081	03-1992 →	81717
	45	09/91 →	1.288	B	M	4	8	BA32108	→ 02-1992	81619
1300	45	09/91 →	1.288	B	M	4	8	BA32108	03-1992 →	81717
	48	01/86 → 12/94	1.288	B	M	4	8	BA32108	→ 02-1992	81619
	48	01/86 → 12/94	1.288	B	M	4	8	BA32108	03-1992 →	81717
	50	02/96 →	1.288	B	M	4	8	BA321115		81717
	52	02/95 →	1.499	B	M	4	8	BA32111		81717
1500	50	09/91 →	1.500	B	M	4	8	BA321083	→ 02-1992	81619
	50	09/91 →	1.500	B	M	4	8	BA321083	03-1992 →	81717

**Samara Forma**

1.5	57	01/00 →	1.499	B	M	4	8	VAZ-2111		81717
1100	39	07/91 →	1.100	B	M	4	8	BA321081	→ 02-1992	81619
	39	07/91 →	1.100	B	M	4	8	BA321081	03-1992 →	81717
1300	45	07/91 →	1.288	B	M	4	8	BA32108	→ 02-1992	81619
	45	07/91 →	1.288	B	M	4	8	BA32108	03-1992 →	81717
	46	05/90 →	1.288	B	M	4	8	BA32108	→ 02-1992	81619
	46	05/90 →	1.288	B	M	4	8	BA32108	03-1992 →	81717
	48	05/89 → 07/97	1.288	B	M	4	8	BA32108	→ 02-1992	81619
	48	05/89 → 07/97	1.288	B	M	4	8	BA32108	03-1992 →	81717
	50	02/96 →	1.288	B	M	4	8	BA321115		81717
	52	11/94 →	1.499	B	M	4	8	BA32111		81717
1500	50	07/91 →	1.500	B	M	4	8	BA321083	→ 02-1992	81619
	50	07/91 →	1.500	B	M	4	8	BA321083	03-1992 →	81717
	53	09/91 →	1.500	B	M	4	8	BA321083	→ 02-1992	81619
	53	09/91 →	1.500	B	M	4	8	BA321083	03-1992 →	81717

**Toscana**

1500	55	09/83 → 02/93	1.458	B	M	4	8	BA32103		81999
------	----	---------------	-------	---	---	---	---	---------	--	-------

**KW**

**cm<sup>3</sup>**

**NO. OF VALVES**

**LANCIA**
**Dedra, Station Wagon**

1.6	66	10/94 → 07/99	1.581	B	M	4	8	159B9.000	(-)COP	81339
	66	10/94 → 07/99	1.581	B	M	4	8	159B9.000	(+)COP	81303
1.6 16V	76	01/96 → 07/99	1.581	B	M	4	16	182A4.000	(-)COP	81339
	76	01/96 → 07/99	1.581	B	M	4	16	182A4.000	(+)COP	81303
1.6 i.e.	55	04/93 → 07/99	1.581	B	M	4	8	835C1.000	(-)COP	81339
	55	04/93 → 07/99	1.581	B	M	4	8	835C1.000	(+)COP	81303
	57	08/89 → 03/93	1.581	B	M	4	8	835A1.046	(-)COP	81314
	57	08/89 → 03/93	1.581	B	M	4	8	835A1.046	(+)COP	81476
	57	08/89 → 03/93	1.581	B	M	4	8	835A1.046	(+)SS	81333
	66	08/89 → 06/94	1.581	B	M	4	8	835A1.000	(-)COP	81314
	66	08/89 → 06/94	1.581	B	M	4	8	835A1.000	(+)COP	81476
	66	08/89 → 06/94	1.581	B	M	4	8	835A1.000	(+)SS	81333
1.6 LE	66	07/94 → 07/99	1.581	B	M	4	8	159B9.000	(-)COP	81339
	66	07/94 → 07/99	1.581	B	M	4	8	159B9.000	(+)COP	81303
1.8 16V LE	83	03/96 → 07/99	1.747	B	M	4	16	182A2.000		81331
1.8 GT 16V	96	03/96 → 07/99	1.747	B	M	4	16	183A1.000		81331
1.8 i.e.	66	08/93 → 07/99	1.756	B	M	4	8	835C5.000		81315
	74	07/94 → 07/99	1.756	B	M	4	8	836A5.000		81315
	77	09/89 → 07/99	1.756	B	M	4	8	835A2.046	05-1994 →	81315
	77	09/89 → 07/99	1.756	B	M	4	8	835A2.046	09-1989 →, → 04-1994	81460
	80	09/89 → 06/94	1.756	B	M	4	8	835A2.000		81460
1.9 TDS	66	07/94 → 07/99	1.929	D	M	4	8	160D1.000, 835A4.000	(-)COP	81363
	66	07/94 → 07/99	1.929	D	M	4	8	160D1.000, 835A4.000	(+)COP	81347
	66	04/89 → 07/99	1.929	D	M	4	8	160D1.000, 835A4.000, 835A4.046	(-)COP, → 04-1994	81326
	66	04/89 → 07/99	1.929	D	M	4	8	160D1.000, 835A4.000, 835A4.046	(-)COP, 05-1994 →	81363
	66	04/89 → 07/99	1.929	D	M	4	8	160D1.000, 835A4.000, 835A4.046	(+)COP, → 04-1994	81464
	66	04/89 → 07/99	1.929	D	M	4	8	160D1.000, 835A4.000, 835A4.046	(+)COP, 05-1994 →	81347
2.0 16V	102	07/94 → 07/99	1.995	B	M	4	16	836A3.000		81322
2.0 HF Integrale	124	11/90 → 07/94	1.995	B	M	4	8	835A7.046		81315
2.0 i.e.	83	09/89 → 07/99	1.995	B	M	4	8	835A5.046	05-1994 →	81315
	83	09/89 → 07/99	1.995	B	M	4	8	835A5.046	09-1989 →, → 04-1994	81460
	86	09/89 → 07/92	1.995	B	M	4	8	835A5.000		81460
2.0 i.e. Turbo	119	04/91 → 07/99	1.995	B	M	4	8	835A8.046		81315
2.0 i.e. Turbo Integrale	121	05/90 → 07/94	1.995	B	M	4	8	835A7.000		81315
2.0 Integrale	102	07/94 → 07/99	1.995	B	M	4	16	836A3.000		81322
2.0 Turbo	130	11/90 → 06/94	1.995	B	M	4	8	835A8.000		81315

--	--	--	--	--	--	--	--	--	--

## LANCIA

### Delta I

1.1	47	01/86 → 12/90	1.116	B	M	4	8	831B8.000	(-)COP	81481
1.3	58	09/83 → 08/92	1.301	B	M	4	8	831A2.000	(-)COP	81481
	55	09/79 → 08/92	1.301	B	M	4	8	831A2.000, 831B.000	(-)COP	81481
1.5	63	09/79 → 12/92	1.498	B	M	4	8	831A1.000, 831B1.000	(-)COP, → 03-1986	81481
1.6 GT i.e.	66	05/87 → 08/92	1.585	B	M	4	8	149C2.000		81436
1.6 HF Turbo	122	08/86 → 05/93	1.585	B	M	4	8			81436
2.0 16V HF Evo Integrale	155	06/93 → 01/94	1.995	B	M	4	16	831E5.000, 831E5.046		81490
2.0 16V HF Integrale	144	03/89 → 09/91	1.995	B	M	4	16	831D5.000		81490
2.0 HF Integrale	130	12/86 → 12/92	1.995	B	M	4	8	831C5.046		81490

### Delta II

1.4 i.e.	51	10/94 → 08/99	1.372	B	M	4	8	160A1.046, 836A4.000	(-)COP, 04-1995 →	81339
	51	10/94 → 08/99	1.372	B	M	4	8	160A1.046, 836A4.000	(+)COP, 04-1995 →	81303
	51	10/94 → 08/99	1.372	B	M	4	8	160A1.046, 836A4.000	→ 03-1995	81333
1.6 i.e.	55	06/93 → 08/99	1.581	B	M	4	8	835C1.000	(-)COP, 04-1995 →, (+)SS, (+)AC	81339
	55	06/93 → 08/99	1.581	B	M	4	8	835C1.000	(+)COP, 04-1995 →, (+)SS, (+)AC	81303
	55	06/93 → 08/99	1.581	B	M	4	8	835C1.000	→ 03-1995	81333
1.6 i.e. 16V	66	03/96 → 08/99	1.581	B	M	4	16	182A6.000	(-)COP	81364
	66	03/96 → 08/99	1.581	B	M	4	16	182A6.000	(+)COP	81341
1.6 i.e. 16V	76	01/96 → 08/99	1.581	B	M	4	16	182A4.000	(-)COP	81364
	76	01/96 → 08/99	1.581	B	M	4	16	182A4.000	(+)COP	81341
1.8 i.e.	66	07/94 → 08/99	1.756	B	M	4	8	835C4.000, 836A6.000, 836C4.000		81315
	76	06/93 → 08/99	1.756	B	M	4	8	835C2.000		81315
1.8 i.e. 16V	83	03/96 → 08/99	1.747	B	M	4	16	182A2.000		81331
1.8 i.e. 16V GT	96	03/96 → 08/99	1.747	B	M	4	16	183A1.000		81331
1.9 TD	66	10/94 → 08/99	1.929	D	M	4	8	160D1.000, 835A4.000	(-)COP	81363
	66	10/94 → 08/99	1.929	D	M	4	8	160D1.000, 835A4.000	(+)COP	81347
2.0 16V	102	06/93 → 08/99	1.995	B	M	4	16	836A3.000		81322
2.0 16V Turbo	137	06/93 → 08/99	1.995	B	M	4	16	836A2.000		81322
	142	07/96 → 08/99	1.995	B	M	4	16	175A4.000		81322

### Delta III

1.4	88	09/08 → 08/14	1.368	B	M	4	16	198A4.000	PIERBURG	81369
	88	09/08 → 08/14	1.368	B	M	4	16	198A4.000	TESMA	82070
	110	09/08 → 08/14	1.368	B	M	4	16	198A1.000	PIERBURG	81369
	110	09/08 → 08/14	1.368	B	M	4	16	198A1.000	TESMA	82070
1.4 16V	103	07/10 → 08/14	1.368	B	M	4	16	198A7.000	TESMA	82070
1.4 Bifuel	88	07/11 → 08/14	1.368	BF	M	4	16	198A4.000	TESMA	82070
1.6 D Multijet	77	04/11 → 08/14	1.598	D	M	4	16	944A3.000		81872
	85	08/08 → 08/14	1.598	D	M	4	16	955A4.000		81872
	88	09/08 → 08/14	1.598	D	M	4	16	198A2.000		81872
1.8	147	01/09 → 08/14	1.742	B	M	4	16	939B1.000		81331

**KW**

**cm<sup>3</sup>**

**NO. OF VALVES**

**LANCIA**
**Delta III**

1.9 D Multijet	140	01/09 → 08/14	1.910	D	M	4	16	844A1.000		81872
2.0 D Multijet	120	09/08 → 08/14	1.956	D	M	4	16	844A2.000		81872
	121	09/08 → 08/14	1.956	D	M	4	16	198A5.000, 198A8.000		81872

**Kappa, Station Wagon, Coupé**

2.0 16V Turbo	151	02/95 → 10/01	1.995	B	M	4	16	838A4.000		81490
2.0 20V	114	07/96 → 03/01	1.998	B	M	5	20	838A6.000		81329
	107	10/94 → 10/01	1.998	B	M	5	20	838A1.000		81329
	114	07/96 → 10/01	1.998	B	M	5	20	838A6.000		81329
2.0 20V Turbo	162	06/98 → 10/01	1.998	B	M	5	20	175A3.000		81329
2.4 20V	129	11/96 → 03/01	2.446	B	M	5	20	838A2.000		81329
	129	08/94 → 10/01	2.446	B	M	5	20	838A2.000, 838A2.027		81329
2.4 JTD	100	06/98 → 10/01	2.387	D	M	5	10	838A8.000		81352
2.4 T.DS	91	08/94 → 10/01	2.387	D	M	5	10	838A3.000, 838A7.000	→ 08-1997, → M: 727.390	81330
	91	08/94 → 10/01	2.387	D	M	5	10	838A3.000, 838A7.000	09-1997 →, M →: 727.391	81352
3.0 24V	150	08/94 → 10/01	2.959	B	M	6	24	838B.000		81355

**Lybra, Station Wagon**

1.6	76	10/00 → 10/05	1.596	B	M	4	16	182B6.000	(-)COP	81364
	76	10/00 → 10/05	1.596	B	M	4	16	182B6.000	(+)COP	81341
1.6 16V	76	07/99 → 10/05	1.581	B	M	4	16	182A4.000, 182B6.000	(-)COP	81364
	76	07/99 → 10/05	1.581	B	M	4	16	182A4.000, 182B6.000	(+)COP	81341
1.8 16V	96	07/99 → 10/05	1.747	B	M	4	16	839A4.000, 839A7.000		81331
	96	07/99 → 10/05	1.747	B	M	4	16	839A4.000, 839A7.000, 839A9.000		81331
1.9 JTD	85	05/01 → 10/05	1.910	D	M	4	8	937A2.000		81352
	77	07/99 → 09/00	1.910	D	M	4	8	AR32302		81352
	81	09/00 → 05/01	1.910	D	M	4	8	AR37101		81352
2.0 20V	110	09/00 → 10/05	1.998	B	M	5	20	185A8.000		81329
	113	07/99 → 09/00	1.998	B	M	5	20	182B7.000		81329
2.4 20V	125	10/01 → 10/05	2.446	B	M	5	20	192A2.000		81329
2.4 JTD	110	05/02 → 10/05	2.387	D	M	5	10	841C.000		81796
	110	05/02 → 10/05	2.387	D	M	5	10	841C.000		81352
	99	07/99 → 02/01	2.387	D	M	5	10	839A5.000, AR32501		81352
	103	09/00 → 05/02	2.387	D	M	5	10	839A6.000		81352

**Musa**

1.3 D Multijet	51	10/04 → 09/12	1.248	D	M	4	16	188A9.000		81862
	66	09/06 → 09/12	1.248	D	M	4	16	199A3.000		81862
	70	03/09 → 09/12	1.248	D	M	4	16	199B1.000		81862
1.4	57	09/05 → 09/12	1.368	B	M	4	8	350A1.000	PIERBURG	81369
	57	09/05 → 09/12	1.368	B	M	4	8	350A1.000	TESMA	82070
	66	10/07 → 09/12	1.368	B	M	4	16	192B2.000	TESMA	82070
	70	10/04 → 09/12	1.368	B	M	4	16	843A1.000	PIERBURG	81369
	70	10/04 → 09/12	1.368	B	M	4	16	843A1.000	TESMA	82070

--	--	--	--	--	--	--	--	--	--	--

## LANCIA

### Musa

1.4 LPG	57	11/10 → 09/12	1.368		M	4	8	350A1.000	TESMA	82070
1.6 D Multijet	85	07/08 → 09/12	1.598	D	M	4	16	350A2.000, 350A3.000		81872
	88	07/08 → 09/12	1.598	D	M	4	16	350A2.000		81872
	74	10/04 → 09/12	1.910	D	M	4	8	188B2.000		81352

### Phedra

2.0	100	09/02 → 11/10	1.997	B	M	4	16	RFN (EW10J4)	(-)COP	84038	<b>NEW</b>
	100	09/02 → 11/10	1.997	B	M	4	16	RFN (EW10J4)	(+)COP	82089	
	100	09/02 → 11/10	1.997	B	M	4	16	RFN (EW10J4)		82089	
	100	09/02 → 11/10	1.997	B	M	4	16	RFN (EW10J4)		81799	
2.0 D Multijet	100	07/06 → 11/10	1.997	D	M	4	16	RHR (DW10BTED4)		81800	
2.0 JTD	79	07/03 → 11/10	1.997	D	M	4	16	RHM (DW10ATED4)		81713	
	88	06/06 → 11/10	1.997	D	M	4	16	RHK (DW10UTED4)		81800	
	80	09/02 → 11/10	1.997	D	M	4	16	RHW (DW10ATED4)		81713	
2.2 D Multijet	125	03/08 → 11/10	2.179	D	M	4	16	4HS, 4HT		82068	
2.2 JTD	120	04/06 → 11/10	2.179	D	M	4	16	4HP, 4HR		82068	
	94	09/02 → 11/10	2.179	D	M	4	16	4HW (DW12ATED4)		81800	
3.0 V6	150	09/02 → 11/10	2.946	B	M	6	24	ES9J4S		81813	

### Prisma

1.3	58	01/83 → 02/92	1.301	B	M	4	8	831A2.000	(-)COP	81481
1.6	73	08/86 → 02/92	1.585	B	M	4	8	831B6.000		81436

### Thema I, Station Wagon

2000 16V	112	08/92 → 12/93	1.995	B	M	4	16	834F1.000		81490
2000 16V Turbo	133	12/88 → 06/90	1.995	B	M	4	16	834C1.000		81490
	148	10/92 → 07/94	1.995	B	M	4	16	834F2.000		81490
2000 i.e	86	09/88 → 05/92	1.995	B	M	4	8	834B1.000		81460
	85	09/87 → 05/92	1.995	B	M	4	8	834B.146		81460
2000 i.e. 16V	104	02/89 → 05/92	1.995	B	M	4	16	834B2.246		81490
	108	05/88 → 08/92	1.995	B	M	4	16	834B2.000		81490
2000 i.e. 16V Turbo	130	04/89 → 05/92	1.995	B	M	4	16	834C1.246		81490
	133	12/88 → 06/90	1.995	B	M	4	16	834C1.000		81490
2000 i.e.Turbo	110	07/86 → 05/90	1.995	B	M	4	8	834C.146	12-1985 →, → 05-1990	81460
2000 Turbo	110	01/89 → 03/92	1.995	B	M	4	8	834C.146		81460
2000 Turbo 16V	148	11/92 → 07/94	1.995	B	M	4	16	834F2.000		81490
2500 Turbo DS	85	06/88 → 05/92	2.499	D	M	4	8	8144.97	11-1991 →	81324
	77	05/88 → 07/92	2.500	D	M	4	8	8144.97S	11-1991 →	81324
	85	05/92 → 07/94	2.500	D	M	4	8	8144.97Y		81325
3000 V6	126	08/92 → 07/94	2.959	B	M	6	12	834F.000		81331

### Thesis

2.0 Turbo	136	07/02 → 07/09	1.998	B	M	5	20	841E.000		81329
2.4	125	07/02 → 07/09	2.446	B	M	5	20	841D.000		81329
2.4 D Multijet	136	04/06 → 07/09	2.387	D	M	5	20	841P.000		81872

**KW**

**cm<sup>3</sup>**

**NO. OF VALVES**

**LANCIA**
**Thesis**

2.4 JTD	120	09/03 → 07/09	2.387	D	M	5	20	841M.000, 841N.000		81872
	129	05/03 → 07/09	2.387	D	M	5	20	841G.000		81872
	110	07/02 → 07/09	2.387	D	M	5	10	841C.000		81352
3.0 V6	158	07/02 → 07/09	2.959	B	A	6	24	841A.000		81355
	169	05/03 → 07/09	3.179	B	M	6	24	841L.000		81355

**Y10**

1.0 Fire	37	03/85 → 02/90	999	B	M	4	8	156A2.000		81801
	32	06/85 → 06/91	999	B	M	4	8	156A2.100		81801
	33	03/85 → 02/92	999	B	M	4	8	156A2.000, 156A2.246		81801
1.0 Fire Trazione integrale	37	12/87 → 02/90	999	B	M	4	8	156A2.000		81801
	33	12/87 → 02/92	999	B	M	4	8	156A2.000, 156A2.246		81801
1.1 Fire	40	01/95 → 12/95	1.108	B	M	4	8	176B2.000		81801
1.1 Fire Trazione integrale	40	01/95 → 12/95	1.108	B	M	4	8	176B2.000		81801
1.1 i.e Fire	42	08/89 → 06/92	1.108	B	M	4	8	156C.000		81801
1.1 i.e Fire Trazione integrale	42	08/89 → 06/92	1.108	B	M	4	8	156C.000		81801
1.1 i.e. Fire	37	07/89 → 09/95	1.108	B	M	4	8	156C.046		81801
1.1 i.e. Fire Trazione integrale	37	09/92 → 12/95	1.108	B	M	4	8	156C.046		81801
1.3 i.e.	53	02/89 → 12/95	1.297	B	M	4	8	146A5.046, 156B.000		81434
	56	11/87 → 05/93	1.301	B	M	4	8	156B.000		81434

**Y**

1.1	40	11/95 → 09/03	1.108	B	M	4	8	176B2.000		81801
1.2	44	03/96 → 09/03	1.242	B	M	4	8	188A4.000, 840A3.000	→ 08-2000	81801
	44	03/96 → 09/03	1.242	B	M	4	8	188A4.000, 840A3.000	09-2000 →, MAGMA	81370
1.2 16V	59	10/00 → 09/03	1.242	B	M	4	16	188A5.000	PIERBURG	81369
	63	04/97 → 09/03	1.242	B	M	4	16	176B9.000	PIERBURG	81369
1.4 12V	55	03/96 → 09/03	1.370	B	M	4	12	840A4.000	→ M: 705.144	81340
	55	03/96 → 09/03	1.370	B	M	4	12	840A4.000	M →: 705.145	81351
	59	10/96 → 09/03	1.370	B	M	4	12	840A2.000	→ M: 705.144	81340
1.4 12V	59	10/96 → 09/03	1.370	B	M	4	12	840A2.000	M →: 705.145	81351

**Ypsilon I**

1.2	44	10/03 → 12/11	1.242	B	M	4	8	188A4.000	MAGMA	81370
	44	10/03 → 12/11	1.242	B	M	4	8	188A4.000	TESMA	82070
	51	08/10 → 12/11	1.242	B	M	4	8	169A4.000	TESMA	82070
	59	10/03 → 12/11	1.242	B	M	4	16	188A5.000	PIERBURG	81369
	59	10/03 → 12/11	1.242	B	M	4	16	188A5.000	TESMA	82070
1.3 D Multijet	55	09/06 → 12/11	1.248	D	M	4	16	199A2.000		81862
	66	09/06 → 12/11	1.248	D	M	4	16	199A3.000		81862
	77	05/07 → 12/11	1.248	D	M	4	16	199A3.000		81862
1.3 JTD	51	10/03 → 12/11	1.248	D	M	4	16	188A9.000		81862
1.4	57	02/06 → 12/11	1.368	B	M	4	8	350A1.000	PIERBURG	81369
	57	02/06 → 12/11	1.368	B	M	4	8	350A1.000	TESMA	82070



--	--	--	--	--	--	--	--	--	--

## LANCIA

### Ypsilon I

1.4 16V	70	10/03 → 12/11	1.368	B	M	4	16	843A1.000	PIERBURG	81369
	70	10/03 → 12/11	1.368	B	M	4	16	843A1.000	TESMA	82070
1.4 LPG	57	11/10 → 12/11	1.368		M	4	8	350A1.000	TESMA	82070

### Ypsilon II

0.9 CNG	63	05/11 →	875		M	2	8	312A2.000		84008
0.9 Twinair	59	12/13 →	875	B	M	2	8	312A2.000, 312A5.000		84008
	63	05/11 →	875	B	M	2	8	312A2.000		84008
1.2	51	05/11 →	1.242	B	M	4	8	169A4.000	TESMA	82070
1.2 Bifuel	49	05/11 →	1.242	BF	M	4	8	169A4.000	TESMA	82070
	51	05/11 →	1.242	BF	M	4	8	169A4.000	TESMA	82070
1.3 Multijet	70	05/11 →	1.248	D	M	4	16	199B1.000		81862

### Zeta

2.0 16V	100	07/00 → 09/02	1.997	B	M	4	16	RFN	(-)COP	84038	
	100	07/00 → 09/02	1.997	B	M	4	16	RFN	(+)COP	82089	
	100	07/00 → 09/02	1.997	B	M	4	16	RFN		82089	
	100	07/00 → 09/02	1.997	B	M	4	16	RFN		81799	
	97	05/98 → 07/00	1.998	B	M	4	16	RFV (XU10J4R)		81711	
2.0 JTD	80	04/00 → 09/02	1.997	D	M	4	8	RHZ (DW10ATED)		81713	
2.0 JTD 16V	80	09/99 → 09/02	1.997	D	M	4	16	RHW, RHW (DW10ATED4)		81713	
2.0 Turbo	108	05/95 → 09/02	1.998	B	M	4	8	RGX (XU10J2TE)		81642	
2.1 TD	80	05/96 → 09/99	2.088	D	M	4	12	P8C		81353	

## LAND ROVER

### Defender Cabrio, Station Wagon, Pickup

2.4 Td4 4x4	90	05/07 →	2.402	D	M	4	16	ZSD-424		82057
-------------	----	---------	-------	---	---	---	----	---------	--	-------

### Discovery I

2.0 16 V 4x4	99	06/89 → 10/98	1.994	B	M	4	16	20T4H		81707
--------------	----	---------------	-------	---	---	---	----	-------	--	-------

### Discovery Sport

2.0 4WD	177	12/14 →	1.999	B	M	4	16	204PT		81804
2.2 D 4WD	110	12/14 →	2.179	D	M	4	16	224DT		82068
	140	12/14 →	2.179	D	M	4	16	224DT		82068

### Freelander I

2.0 DI 4x4	72	02/98 → 11/00	1.994	D	M	4	8	20T2N		81707
2.5 V6 4x4	130	11/00 → 10/06	2.497	B	M	6	24	25K4F		82029

### Freelander II

2.0 Si4 4x4	177	10/11 → 10/14	1.999	B	M	4	16	204PT		81804
2.2 eD4	110	08/10 → 10/14	2.179	D	M	4	16	224DT, DW12BTED4		82068
2.2 SD4 4x4	140	08/10 → 10/14	2.179	D	M	4	16	224DT		82068
2.2 TD4 4x4	110	10/06 → 10/14	2.179	D	M	4	16	224DT, DW12BTED4		82068
	112	01/07 → 10/14	2.179	D	M	4	16	224DT		82068
	115	10/06 → 10/14	2.179	D	M	4	16	224DT		82068
	118	10/06 → 10/14	2.179	D	M	4	16	224DT, DW12BTED4		82068

**KW**

**cm<sup>3</sup>**

**NO. OF VALVES**

**MAGNETI MARELLI**

## LAND ROVER

### Range Rover Evoque, Cabrio

2.0 4x4	177	06/11 →	1.999	B	M	4	16	204PT		81804
2.2 D	110	06/11 →	2.179	D	M	4	16	224DT		82068
2.2 D 4x4	110	06/11 →	2.179	D	M	4	16	224DT		82068
	140	06/11 →	2.179	D	M	4	16	224DT		82068

### Range Rover II

2.5 D 4x4	100	07/94 → 03/02	2.497	D	M	6	12	256T (BMW)		81597
-----------	-----	---------------	-------	---	---	---	----	------------	--	-------

### Range Rover III

3.0 D 4x4	130	03/02 → 08/12	2.926	D	M	6	24	306D1		81795
-----------	-----	---------------	-------	---	---	---	----	-------	--	-------

## LEXUS

### HS

250h	110	07/09 →	2.362		M	4	16	2AZ-FXE		82055
------	-----	---------	-------	--	---	---	----	---------	--	-------

### IS II

200d	110	07/10 →	2.231	D	M	4	16	2AD-FTV		82071
220d	130	10/05 →	2.231	D	M	4	16	2AD-FHV		82071

### RX I

300	148	07/00 → 03/03	2.995	B	M	6	24	1MZ-FE		82051
300 AWD	148	10/00 → 05/03	2.995	B	A	6	24	1MZ-FE		82051
	164	07/00 → 05/03	2.995	B	M	6	24	1MZ-FE		82051

### RX II

300	150	05/03 → 12/08	2.995	B	M	6	24	1MZ-FE		82051
330	171	04/03 → 01/06	3.311	B	M	6	24	3MZ-FE		82051
330 AWD	171	04/03 → 12/08	3.311	B	M	6	24	3MZ-FE		82051
400h	155	09/05 → 12/08	3.311		M	6	24	3MZ-FE		82051
400h AWD	155	09/04 → 12/08	3.311		M	6	24	3MZ-FE		82051

## LOTUS

### Elise I

1.8	88	08/95 → 11/00	1.796	B	M	4	16	18K4F		81615
111 S	107	03/99 → 11/00	1.796	B	M	4	16	18K4K		81615

## MAZDA

### 2 I

1.2	55	02/03 →	1.242	B	M	4	16	FUJA		81598
1.25	55	04/03 →	1.242	B	M	4	16	FUJA		81598
1.3 L	67	04/03 → 06/07	1.348	B	M	4	16	ZJ04		81598
1.4	59	02/03 →	1.388	B	M	4	16	FXJA		81598
1.4 CD	50	04/03 →	1.399	D	M	4	8	F6JA, F6JB		81798
1.6	74	02/03 →	1.596	B	M	4	16	FYJA		81598

### 2 II, Saloon

1.3	55	10/07 → 06/15	1.349	B	M	4	16	ZJ-VE		84060	<b>NEW</b>
	63	10/07 → 06/15	1.349	B	M	4	16	ZJ-VE		84060	<b>NEW</b>
1.3 BiFuel	55	05/11 → 11/14	1.349	BF	M	4	16	ZJ46		84060	<b>NEW</b>
	62	05/11 → 11/14	1.349	BF	M	4	16	ZJ46		84060	<b>NEW</b>

**KW**

**cm<sup>3</sup>**

**NO. OF VALVES**

**MAZDA**
**2 II, Saloon**

1.3 MZR	62	01/10 → 06/15	1.349	B	M	4	16	ZJ-VE		84060	<b>NEW</b>
1.4 MZR-CD	50	01/08 → 06/15	1.399	D	M	4	8	Y404		81798	
1.5	76	10/07 → 06/15	1.498	B	M	4	16	ZY-DE, ZY-VE		84060	<b>NEW</b>
1.5 MZR	75	06/11 → 06/15	1.498	B	M	4	16	ZY05, ZY66		84060	<b>NEW</b>
1.6 MZ-CD	66	10/08 → 06/15	1.560	D	M	4	16	Y406, Y646		81869	
	70	06/11 → 06/15	1.560	D	M	4	8	Y655, Y661		81869	

**3 I, Saloon**

1.4	62	10/03 → 06/09	1.349	B	M	4	16	ZJ-VE		84060	<b>NEW</b>
	59	02/04 → 06/09	1.388	B	M	4	16	FXJA		84060	<b>NEW</b>
1.6	77	10/03 → 06/09	1.598	B	M	4	16	B6ZE		84060	<b>NEW</b>
	77	02/04 → 06/09	1.598	B	M	4	16	Z6		84060	<b>NEW</b>
1.6 DI Turbo	80	06/04 → 06/09	1.560	D	M	4	16	Y601		81869	
1.6 MZ-CD	66	06/06 → 12/09	1.560	D	M	4	16	Y406		81869	
2.0	110	10/03 → 06/09	1.999	B	M	4	16	LF17		81804	
2.0 MZR-CD	105	12/06 → 06/09	1.998	D	M	4	16	RF7J		82092	
2.3	118	03/04 → 03/09	2.261	B	M	4	16	L3-VE		81804	
	126	06/00 → 03/03	2.261	B	M	4	16	L3-VE		81804	
2.3 DiSi Turbo MPS	184	06/06 → 06/09	2.261	B	M	4	16	L3YH		81804	
2.3 MPS Turbo	191	12/06 → 06/09	2.261	B	M	4	16	L3-VDT, L3N9		81804	
2.3 MZR	115	03/04 → 03/09	2.261	B	M	4	16	L3-VE		81804	
2.3 MZR Sport	126	10/03 → 06/09	2.261	B	M	4	16	L3YS, L3YT		81804	

**3 II, Saloon**

1.6 MZR	77	06/09 →	1.598	B	M	4	16	Z6		84060	<b>NEW</b>
1.6 MZR CD	80	12/08 →	1.560	D	M	4	16	Y601, Y642		81869	
	80	12/08 →	1.560	D	M	4	16	Y642		81869	
	85	11/10 →	1.560	D	M	4	8	Y650, Y655		81869	
2.0 MZR	110	06/09 →	1.999	B	M	4	16	LF-DE, LF17		81804	
2.0 MZR DISI	111	06/09 →	1.999	B	M	4	16	LF5H, LF5W		81804	
2.3 MPS Turbo	191	06/09 →	2.261	B	M	4	16	L3-VDT, L3KG		81804	

**3 III, Saloon**

1.6	77	09/13 →	1.598	B	M	4	16	Z6Y1		84060	<b>NEW</b>
	77	09/13 →	1.598	B	M	4	16	Z6Y1, Z6Y3		84060	<b>NEW</b>

**5 I**

1.8	85	03/05 →	1.798	B	M	4	16	L823		81804	
2.0	107	03/05 →	1.999	B	M	4	16	LFF7		81804	
2.0 CD	81	03/05 →	1.998	D	M	4	16	RF7J		82092	
	105	06/05 →	1.998	D	M	4	16	RF7J		82092	
2.3	122	02/05 →	2.261	B	M	4	16			81804	

**5 II**

1.6 CD	85	09/10 →	1.560	D	M	4	8	Y650, Y655		81869	
1.8 MZR	85	09/10 →	1.798	B	M	4	16	L850		81804	
2.0	106	01/11 →	1.999	B	M	4	16	LFZB		81804	
	110	09/10 →	1.999	B	M	4	16	LF5H		81804	

**KW**

**cm<sup>3</sup>**

**NO. OF VALVES**

**MAGNETI MARELLI**
**MAZDA**
**6 I, Hatchback, Station Wagon**

1.8	88	08/02 → 08/07	1.798	B	M	4	16	L813		81804
	88	08/02 → 08/07	1.798	B	M	4	16	L813, L823, L828		81804
2.0	104	06/02 → 08/07	1.999	B	M	4	16	LF17, LF18		81804
	108	03/05 → 08/07	1.999	B	M	4	16	LFF7		81804
2.0 CiTD 4x4	89	10/02 → 02/05	1.998	D	M	4	16	RF5C		82092
	100	10/02 → 02/05	1.998	D	M	4	16	RF5C		82092
2.0 DI	89	08/02 → 08/07	1.998	D	M	4	16	RF5C		82092
	100	06/02 → 08/07	1.998	D	M	4	16	RF5C		82092
	105	06/05 → 08/07	1.998	D	M	4	16	RF7J		82092
2.3	122	06/02 → 08/07	2.261	B	M	4	16	L3C1		81804
2.3 AWD	119	11/02 → 08/07	2.261	B	M	4	16	L3C1		81804
2.3 MPS Turbo	191	12/05 → 08/07	2.261	B	M	4	16	L3KG		81804
2.5	125	08/07 →	2.488	B	M	4	16	L5-VE		81804

**6 II, Hatchback, Station Wagon**

1.8 MZR	88	08/07 →	1.798	B	M	4	16	L813		81804
2.0 MZR	108	08/07 →	1.999	B	M	4	16	LF17		81804
	114	01/10 →	1.999	B	M	4	16	LF-DE		81804
2.0 MZR-CD	103	08/07 →	1.998	D	M	4	16	RF7J		82092
2.5 MZR	125	08/07 →	2.488	B	M	4	16	L5-VE		81804

**121**

1.25	55	03/96 → 04/03	1.242	B	M	4	16	DHF, DHG		81598
1.3	37	03/96 → 04/03	1.299	B	M	4	8	JJK, JJM		81716
	44	03/96 → 04/03	1.299	B	M	4	8	J4R, J4T		81716
1.3 i 16V	53	11/90 → 03/96	1.324	B	M	4	16	B3 (16V)		81598
1.8 D	44	03/96 → 04/03	1.753	D	M	4	8	RTJ, RTK		81651

**323 F VI**

2.0 TD	66	09/98 → 12/01	1.998	D	M	4	8			82092
	74	01/01 → 05/04	1.998	D	M	4	16	RF4F		82092

**323 S VI**

2.0 DiTD	74	10/00 → 10/02	1.998	D	M	4	16	RF4F		82092
2.0 TD	66	09/98 → 05/04	1.998	D	M	4	16	RF3F		82092

**626 V, Hatchback, Station Wagon**

2.0 DI TD	66	04/98 → 10/02	1.998	D	M	4	16	RF3F		82092
	66	04/98 → 10/02	1.998	D	M	4	16	RF3F		82092
2.0 TD	81	10/00 → 10/02	1.998	D	M	4	8	RF59		82092
	81	10/00 → 10/02	1.998	D	M	4	8			82092
2.0 Turbo DI	74	04/98 → 10/02	1.998	D	M	4	16	RF4F		82092
	74	04/98 → 10/02	1.998	D	M	4	8			82092

**CX - 7**

2.3 MZR DISI Turbo	190	10/07 →	2.261	B	M	4	16	L3-VDT		81804
	191	09/09 →	2.261	B	M	4	16	L3-VDT		81804

**MPV**

2.0 DI	100	07/02 → 02/06	1.998	D	M	4	16	RF5C		82092
2.3	104	07/02 → 02/06	2.261	B	M	4	16	L3		81804

--	--	--	--	--	--	--	--	--	--

## MAZDA

### MX - 5 III

1.8	93	03/05 →	1.798	B	M	4	16	L8-DE, L828	81804
2.0	118	09/08 →	1.999	B	M	4	16	LF-DE, LF62	81804

### Premacy

2.0 TD	66	10/99 → 07/00	1.998	D	M	4	16	RF3F	82092
	74	07/00 → 03/05	1.998	D	M	4	16	RF4F	82092
2.3 SVT	122	02/05 → 03/05	2.261	B	M	4	16	L333	81804

### Tribute

2.0	91	03/00 → 05/08	1.989	B	M	4	16	YF	81803
2.0 4WD	91	03/00 → 05/08	1.989	B	M	4	16	YF	81803
2.3 AWD	110	04/04 → 05/08	2.261	B	M	4	16	L3-VE	81804
2.3 GX	110	12/03 → 10/04	2.261	B	M	4	16	L3-VE	81804

## MEGA

### Club I

1.1 i	44	01/92 → 06/99	1.124	B	M	4	8	TU1MC	81556
1.4 i	55	01/92 → 06/99	1.361	B	M	4	8		81513
1.4 i 4x4	55	01/92 → 06/99	1.361	B	M	4	8		81513
1.5 D	43	01/94 → 06/99	1.527	B	M	4	8		81513
1.5 D 4x4	43	01/94 → 06/99	1.527	B	M	4	8		81513

### Club II

1.4 i	55	06/99 →	1.361	B	M	4	8		81513
-------	----	---------	-------	---	---	---	---	--	-------

## MERCEDES-BENZ

### 100

D	41	12/90 → 12/94	2.399	D	M	4	8	OM616	81508
	53	02/88 → 05/92	2.399	D	M	4	8	OM616.963	81508
	55	12/90 → 02/96	2.399	D	M	4	8	OM616, OM616.963	81723
	55	12/90 → 02/96	2.399	D	M	4	8	OM616.963	81508

### 190 (W201)

2.0	75	01/86 → 05/90	1.996	B	M	4	8	M102.924	81509
	77	09/84 → 05/90	1.996	B	M	4	8	M102.924	81509
D 2.0	55	08/89 → 08/93	1.997	D	M	4	8	OM601.911	81504
D 2.5	66	04/85 → 08/93	2.497	D	M	5	10	OM602.911	81506
	69	08/89 → 08/93	2.497	D	M	5	10	OM602.911	81506
E 1.8	80	04/90 → 08/93	1.797	B	M	4	8	M102.910	81509
E 2.0	87	01/85 → 08/93	1.996	B	M	4	8	M102.962	81509
	93	10/82 → 06/93	1.996	B	M	4	8	M102.961	81509
	90	10/82 → 06/93	1.996	B	M	4	8	M102.961, M102.962	81509
E 2.3	97	09/86 → 08/91	2.298	B	M	4	8	M102.985	81509
	100	10/86 → 08/93	2.298	B	M	4	8	M102.985	81509
E 2.5-16	143	03/89 → 08/93	2.498	B	M	4	16	M102.991	81509
	150	09/88 → 08/93	2.498	B	M	4	16	M102.990	05-1991 →, → 05-1993 81509
E 2.6	118	09/86 → 08/93	2.597	B	M	6	12	M103.942	81507

**KW**

**cm<sup>3</sup>**

**NO. OF VALVES**

**MERCEDES-BENZ**
**190 (W201)**

E Evolution II 2.5	173	05/90 → 08/93	2.498	B	M	4	8	M102.992	05-1991 →, → 05-1993	81509
Turbo-D 2.5	90	02/88 → 08/93	2.497	D	M	5	10	OM602.961	01-1985 →, → 05-1993	81506
	93	02/88 → 08/93	2.497	D	M	5	10	OM602.961	01-1985 →, → 05-1993	81506

**Citan**

108 CDI	55	11/12 →	1.461	D	M	4	8	OM607.951		82098
109 CDI	66	11/12 →	1.461	D	M	4	8	OM607.951		82098
	66	11/12 →	1.461	D	M	4	8	OM607.951		82098

**CLA**

CLA 180 CDI / d	80	10/13 →	1.461	D	M	4	8	OM607.951		82098
CLA 180 d	80	07/15 →	1.461	D	M	4	8	OM607.951		82098

**Classe A I (W168)**

A 140	60	07/97 → 08/04	1.397	B	M	4	8	M166.940		82087
	60	01/01 → 08/04	1.598	B	A	4	8	M166.960		82087
A 160	75	07/97 → 08/04	1.598	B	M	4	8	M166.960		82087
A 160 CDI	44	07/98 → 02/01	1.689	D	M	4	16	OM668.941		82087
	55	02/01 → 08/04	1.689	D	M	4	16	OM668.940		82087
A 170 CDI	66	07/98 → 02/01	1.689	D	M	4	16	OM668.940		82087
	70	02/01 → 08/04	1.689	D	M	4	16	OM668.942		82087
A 190	92	03/99 → 08/04	1.898	B	M	4	8	M166.990		82087
A 210	103	03/02 → 08/04	2.084	B	M	4	8	M166.995		82087

**Classe A II (W169)**

A 150	70	09/04 → 06/12	1.498	B	M	4	8	M266.920		82017
A 160	70	04/09 → 06/12	1.498	B	M	4	8	M266.920		82017
A 160 CDI	60	09/04 → 06/12	1.991	D	M	4	16	OM640.942		82017
A 170	85	09/04 → 06/12	1.699	B	M	4	8	M266.940		82017
A 180	85	04/09 → 06/12	1.699	B	M	4	8	M266.940		82017
A 180 CDI	80	09/04 → 06/12	1.991	D	M	4	16	OM640.940		82017
A 200	100	09/04 → 06/12	2.034	B	M	4	8	M266.960		82017
A 200 CDI	100	09/04 → 06/12	1.991	D	M	4	16	OM640.941		82017
	103	09/04 → 06/12	1.991	D	M	4	16	OM640.941		82017
A 200 TURBO	142	09/05 → 06/12	2.034	B	M	4	8	M266.980		82017

**Classe A III (W176)**

A 160 CDI / d	66	06/13 →	1.461	D	M	4	8	OM607.951		82098
A 180 CDI / d	80	06/12 →	1.461	D	M	4	8	OM607.951		82098

**Classe B I (W245)**

B 150	70	03/05 → 11/11	1.498	B	M	4	8	M266.920		82017
B 160	70	04/09 → 11/11	1.498	B	M	4	8	M266.920		82017
B 170	85	03/05 → 11/11	1.699	B	M	4	8	M266.940		82017
B 170 NGT	85	04/08 → 11/11	2.034		M	4	8	M266.960		82017
B 180	85	04/09 → 11/11	1.699	B	M	4	8	M266.940		82017
B 180 CDI	80	03/05 → 11/11	1.991	D	M	4	16	OM640.940		82017

--	--	--	--	--	--	--	--	--	--

## MERCEDES-BENZ

### Classe B I (W245)

B 180 NGT	85	04/08 → 11/11	2.034		M	4	8	M266.960		82017
B 200	100	03/05 → 11/11	2.034	B	M	4	8	M266.960		82017
B 200 CDI	100	03/05 → 11/11	1.991	D	M	4	16	OM640.941		82017
	103	03/05 → 11/11	1.991	D	M	4	16	OM640.941		82017
B 200 TURBO	142	03/05 → 11/11	2.034	B	M	4	8	M266.980		82017

### Classe B II (W246)

B 160 CDI / d	66	05/13 →	1.461	D	M	4	8	OM607.951		82098
B 180 CDI / d	80	02/13 →	1.461	D	M	4	8	OM607.951		82098

### Classe C I (W202), Station Wagon (S202)

C 180	89	11/94 → 05/00	1.799	B	M	4	16	M111.921		81499
	90	03/93 → 05/00	1.799	B	M	4	16	M111.920, M111.921		81499
C 180 T	90	06/96 → 09/00	1.799	B	M	4	16	M111.920, M111.921		81499
	95	09/00 → 03/01	1.998	B	M	4	16	M111.952		81499
C 200	100	01/94 → 05/00	1.998	B	M	4	16	M111.941, M111.945		81499
C 200 CDI	75	03/98 → 05/00	2.151	D	M	4	16	OM611.960		81499
C 200 D	55	03/93 → 05/00	1.997	D	M	4	8	OM601.913		81722
	65	10/96 → 05/00	1.997	D	M	4	16	OM604.915	06-1993 →	81504
C 200 Kompressor	132	10/95 → 05/00	1.998	B	M	4	16	M111.944		81499
	141	11/96 → 05/00	1.998	B	M	4	16	M111.944		81499
C 200 T	100	06/96 → 03/01	1.998	B	M	4	16	M111.941, M111.945		81499
C 200 T CDI	75	03/98 → 03/01	2.151	D	M	4	16	OM611.960		82088
C 200 T D	65	10/96 → 03/01	1.997	D	M	4	16	OM604.915		81723
C 200 T Kompressor	120	09/00 → 03/01	1.998	B	M	4	16	M111.956		81499
	141	11/96 → 03/01	1.998	B	M	4	16	M111.944		81499
C 220	110	03/93 → 05/00	2.199	B	M	4	16	M111.961		81499
C 220 CDI	92	09/97 → 05/00	2.151	D	M	4	16	OM611.960		82088
C 220 D	55	07/96 → 05/00	2.155	D	M	4	16	OM604.910		81723
	70	08/93 → 05/00	2.155	D	M	4	16	OM604.910		81723
C 220 T CDI	92	09/97 → 03/01	2.151	D	M	4	16	OM611.960		82088
C 220 T D	55	06/96 → 03/01	2.155	D	M	4	16	OM604.910		82088
	70	06/96 → 09/98	2.155	D	M	4	16	OM604.910		81499
C 230	110	06/96 → 06/97	2.295	B	M	4	16	M111.974		81499
C 230 Kompressor	142	10/95 → 05/00	2.295	B	M	4	16	M111.975		81725
C 230 T	110	06/96 → 06/98	2.295	B	M	4	16	M111.974		81499
C 230 T Kompressor	142	06/97 → 09/00	2.295	B	M	4	16	M111.975		81725
C 240	125	06/97 → 05/00	2.398	B	M	6	18	M112.910		81730
C 240 T	125	06/97 → 09/00	2.398	B	M	6	18	M112.910		81730
	125	09/00 → 03/01	2.597	B	M	6	18	M112.915		81730
C 250 D	83	05/93 → 05/00	2.497	D	M	5	20	OM605.910		81506
C 250 T Turbo-D	110	06/96 → 03/01	2.497	D	M	5	20	OM605.960		82088
C 250 Turbo-D	110	10/95 → 05/00	2.497	D	M	5	20	OM605.960	01-1997 →	81726
C 280	142	05/93 → 05/00	2.799	B	M	6	24	M104.941		81722
	145	06/97 → 05/00	2.799	B	M	6	18	M112.920		81722
C 280 T	145	06/97 → 03/01	2.799	B	M	6	18	M112.920		81722

**KW**

**cm<sup>3</sup>**

**NO. OF VALVES**

**MERCEDES-BENZ**
**Classe C I (W202), Station Wagon (S202)**

C 36 AMG	206	05/94 → 05/00	3.606	B	M	6	24	M104.941 (AMG3.6)		81722
C 43 AMG	225	08/97 → 05/00	4.266	B	M	8	24	M113.944	01-1998 →	81730

**Classe C II (W203), Station Wagon (S203), Coupé (CL203)**

C 160 Kompressor	90	05/02 → 05/08	1.796	B	M	4	16	M271.921		84004
C 180 Kompressor	105	05/02 → 02/07	1.796	B	M	4	16	M271.946		84004
C 200 CDI	75	02/01 → 02/07	2.148	D	M	4	16	OM646.962		82088
	75	03/01 → 08/07	2.148	D	M	4	16	OM611.962, OM646.962		82082
	85	03/01 → 08/07	2.148	D	AM	4	16	OM611.962		82088
	85	09/00 → 02/07	2.148	D	M	4	16	OM611.962		82088
	90	04/03 → 02/07	2.148	D	M	4	16	OM646.962		82088
C 200 CGI Kompressor	125	07/03 → 02/07	1.796	B	M	4	16	M271.942		84004
C 220	120	05/02 → 05/08	1.796	B	M	4	16	M271.940		84004
C 220 CDI	100	03/01 → 01/04	2.148	D	M	4	16	OM611.962		82088
	100	05/00 → 02/07	2.148	D	M	4	16	OM611.962		82088
	105	03/01 → 08/07	2.148	D	AM	4	16	OM611.962		82088
	105	05/00 → 02/07	2.148	D	M	4	16	OM611.962		82088
	110	02/03 → 02/07	2.148	D	M	4	16	OM646.963		82088
	100	08/06 → 08/07	2.149	D	M	4	16	OM646.963		82088
C 230 Kompressor	141	02/04 → 02/07	1.796	B	M	4	16	M271.948		84004
C 240	125	05/00 → 02/07	2.597	B	M	6	18	M112.912		81730
C 240 4-matic	125	07/02 → 02/07	2.597	B	M	6	18	M112.916		81730
C 270 CDI	120	12/00 → 02/07	2.685	D	M	5	20	OM612.962		82088
	125	03/01 → 08/07	2.685	D	AM	5	20	OM612.962		82088
	125	12/00 → 02/07	2.685	D	M	5	20	OM612.962		82088
C 320	160	09/02 → 05/08	3.199	B	M	6	18	M112.946		81730
	160	05/00 → 02/07	3.199	B	A	6	18	M112.946		81730
C 320 4-matic	160	07/02 → 02/07	3.199	B	M	6	18	M112.953		81730
C 320 CDI	165	01/05 → 02/07	2.987	D	M	6	24	OM642.910		82058
C 55 AMG	270	02/04 → 02/07	5.439	B	M	8	24	M113.988		81730

**Classe C III (W204), Station Wagon (S204), Coupé (C204)**

C 180	115	06/11 →	1.796	B	M	4	16	M271.820		84004
C 180 CDI	88	01/11 → 01/14	2.143	D	M	4	16	OM651.913		84044 <b>NEW</b>
C 180 CGI	115	01/07 → 01/14	1.796	B	M	4	16	M271.820		84004
C 180 Kompressor	115	01/08 → 01/14	1.597	B	M	4	16	M271.910		84004
	115	01/07 → 01/14	1.796	B	M	4	16	M271.952		84004
C 200	137	05/11 → 01/14	1.796	B	M	4	16	M271.820		84004
C 200 CDI	100	01/11 → 01/14	2.143	D	M	4	16	OM651.913		84044 <b>NEW</b>
	100	08/07 → 12/11	2.148	D	M	4	16	OM646.811		82082
	100	01/07 → 12/10	2.148	D	M	4	16	OM646.811, OM646.812		82082
C 200 CGI	135	01/07 → 01/14	1.796	B	M	4	16	M271.820		84004
	135	08/07 → 08/14	1.796	B	M	4	16	M271.820, M271.860		84004
C 200 Kompressor	135	01/07 → 01/14	1.796	B	M	4	16	M271.950		84004



**KW**

**cm<sup>3</sup>**

**NO. OF VALVES**

**MERCEDES-BENZ**
**Classe C III (W204), Station Wagon (S204), Coupé (C204)**

C 220 CDI	120	10/08 → 01/14	2.143	D	M	4	16	OM651.911		84044	<b>NEW</b>
	120	01/07 → 11/08	2.148	D	M	4	16	OM646.811		82082	
	120	06/11 →	2.143	D	M	4	16	OM651.911		84044	<b>NEW</b>
	125	12/08 → 01/14	2.143	D	M	4	16	OM651.911		84044	<b>NEW</b>
	125	01/07 → 11/08	2.148	D	M	4	16	OM646.811		82082	
C 220 CDI 4-matic	125	02/13 → 01/14	2.143	D	M	4	16	OM651.912		84044	<b>NEW</b>
C 250	150	06/11 →	1.796	B	M	4	16	M271.860		84004	
C 250 CDI	150	08/08 → 01/14	2.143	D	M	4	16	OM651.911		84044	<b>NEW</b>
C 250 CDI 4-matic	150	01/11 → 01/14	2.143	D	M	4	16	OM651.912		84044	<b>NEW</b>
C 250 CGI	150	07/09 → 01/14	1.796	B	M	4	16	M271.860		84004	
C 300 CDI 4-matic	170	01/11 → 01/14	2.987	D	M	6	24	OM642.832		82058	
C 320 CDI	165	01/07 → 01/14	2.987	D	M	6	24	OM642.960		82058	
C 320 CDI 4-matic	165	07/07 → 01/14	2.987	D	M	6	24	OM642.961		82058	
C 350 CDI	165	08/07 → 08/14	2.987	D	M	6	24	OM642.830		82058	
	165	07/09 → 01/14	2.987	D	M	6	24	OM642.960		82058	
	170	10/09 → 01/14	2.987	D	M	6	24	OM642.830		82058	
C 350 CDI 4-matic	165	07/09 → 01/14	2.987	D	M	6	24	OM642.961		82058	
	170	10/09 → 01/14	2.987	D	M	6	24	OM642.832		82058	

**Classe C IV (W205), Station Wagon (S205), Coupé (C205)**

C 180 BlueTEC / d	85	05/14 →	1.598	D	M	4	16	OM626.951		84034	<b>NEW</b>
C 200 BlueTEC / d	100	05/14 →	1.598	D	M	4	16	OM626.951		84034	<b>NEW</b>

**Classe CLC**

CLC 160	95	02/09 → 06/11	1.597	B	M	4	16	M271.911		84004	
CLC 180 Kompressor	105	05/08 → 06/11	1.796	B	M	4	16	M271.946		84004	
CLC 200 CDI	90	05/08 → 06/11	2.148	D	M	4	16	OM646.962		82082	
CLC 200 Kompressor	135	05/08 → 06/11	1.796	B	M	4	16	M271.957		84004	
CLC 220 CDI	110	05/08 → 06/11	2.148	D	M	4	16	OM646.963		82082	

**Classe E I (W124), Station Wagon (S124), Cabrio (A124), Coupé (C124)**

E 200	100	06/93 → 03/98	1.998	B	M	4	16	M111.940	06-1993 →	81499	
	100	06/93 → 06/95	1.998	B	M	4	16	M111.940		81499	
E 200 D	55	06/93 → 06/95	1.997	D	M	4	8	OM601.912		81504	
E 200 T	100	06/93 → 06/96	1.998	B	M	4	16	M111.940	06-1993 →, → 01-1996	81499	
E 220	110	06/93 → 03/98	2.199	B	M	4	16	M111.960	06-1993 →	81499	
	110	06/93 → 06/95	2.199	B	M	4	16	M111.960		81499	
E 220 T	110	06/93 → 06/96	2.199	B	M	4	16	M111.960		81499	
E 250 D	83	07/93 → 06/95	2.497	D	M	5	20	OM605.911	→ M: 033.729	81506	
	83	07/93 → 06/95	2.497	D	M	5	20	OM605.911	M →: 033.730	81726	
E 250 TD	83	06/93 → 06/96	2.497	D	M	5	20	OM605.911	01-1985 →	81506	
E 250 Turbo-D	93	06/93 → 06/95	2.497	D	M	5	10	OM602.962	01-1988 →	81506	
E 280	142	06/93 → 06/95	2.799	B	M	6	24	M104.942	06-1993 →, → 06-1995	81722	
	145	06/93 → 06/95	2.799	B	M	6	24	M104.942	06-1993 →, → 06-1995	81722	

**KW**

**cm<sup>3</sup>**

**NO. OF VALVES**

**MERCEDES-BENZ**
**Classe E I (W124), Station Wagon (S124), Cabrio (A124), Coupé (C124)**

E 280 T	142	06/93 → 06/96	2.799	B	M	6	24	M104.942	06-1993 →, → 01-1996	81722
	145	06/93 → 06/96	2.799	B	M	6	24	M104.942	06-1993 →, → 01-1996	81722
E 300 4-matic	132	06/93 → 06/95	2.960	B	M	6	12	M103.985	01-1985 →, → 12-1996, M →: 094.339	81507
E 300 D	100	07/93 → 06/95	2.996	D	M	6	24	OM606.910	06-1993 →	81506
E 300 T 4-matic	132	06/93 → 06/96	2.960	B	M	6	12	M103.985	06-1993 →, → 01-1996	81507
E 300 T Turbo-D	108	06/93 → 06/96	2.996	D	M	6	12	OM603.960	01-1987 →	81506
E 300 T Turbo-D 4-matic	108	06/93 → 06/96	2.996	D	M	6	12	OM603.963	01-1987 →	81506
E 300 TD	100	06/93 → 06/96	2.996	D	M	6	24	OM606.910	07-1995 →	81506
E 300 Turbo-D	108	06/93 → 06/95	2.996	D	M	6	12	OM603.960	06-1993 →	81506
E 300 Turbo-D 4-matic	108	06/93 → 06/95	2.996	D	M	6	12	OM603.963	06-1993 →	81506
E 320	162	06/93 → 06/95	3.199	B	M	6	24	M104.992	06-1993 →	81722
	162	06/93 → 03/98	3.199	B	M	6	24	M104.992, M104.995	06-1993 →	81722
E 320 T	162	06/93 → 06/96	3.199	B	M	6	24	M104.992	06-1993 →	81722
E 36 AMG	200	05/94 → 03/98	3.606	B	M	6	24	M104.992 (AMG3.6)		81722

**Classe E II (W210), Station Wagon (S210)**

E 200	100	06/95 → 08/00	1.998	B	M	4	16	M111.942		81499
E 200 CDI	85	07/99 → 03/02	2.148	D	M	4	16	OM611.961		82088
	75	06/98 → 03/02	2.151	D	M	4	16	OM611.961		82088
E 200 D	65	01/96 → 03/02	1.997	D	M	4	16	OM604.917		81723
E 200 Kompressor	120	08/00 → 03/02	1.998	B	M	4	16	M111.957		81499
	137	06/97 → 03/02	1.998	B	M	4	16	M111.947		81725
E 200 T	100	06/96 → 08/00	1.998	B	M	4	16	M111.942		81499
E 200 T Kompressor	120	08/00 → 03/03	1.998	B	M	4	16	M111.957		81499
	137	06/97 → 03/03	1.998	B	M	4	16	M111.947		81725
E 220 CDI	100	07/99 → 03/02	2.148	D	M	4	16	OM611.961		82088
	105	07/99 → 03/02	2.148	D	M	4	16	OM611.961		82088
	92	06/98 → 07/99	2.151	D	M	4	16	OM611.961		82088
E 220 D	55	05/96 → 03/02	2.155	D	M	4	16	OM604.912		81723
	70	06/95 → 07/99	2.155	D	M	4	16	OM604.912		81723
E 220 T CDI	100	05/99 → 03/03	2.148	D	M	4	16	OM611.961		82088
	105	07/99 → 03/03	2.148	D	M	4	16	OM611.961		82088
	92	06/98 → 07/99	2.151	D	M	4	16	OM611.961		82088
E 230	110	06/95 → 06/97	2.295	B	M	4	16	M111.970		81499
E 230 T	110	06/96 → 06/97	2.295	B	M	4	16	M111.970		81499
E 240	125	06/97 → 08/00	2.398	B	M	6	18	M112.911		81730
	125	08/00 → 03/02	2.597	B	M	6	18	M112.914		81730
E 240 T	125	06/97 → 03/03	2.398	B	M	6	18	M112.911		81730
	125	08/00 → 03/03	2.597	B	M	6	18	M112.914		81730

**KW**

**cm<sup>3</sup>**

**NO. OF VALVES**

**MERCEDES-BENZ**
**Classe E II (W210), Station Wagon (S210)**

E 250 D	83	06/95 → 07/99	2.497	D	M	5	20	OM605.912	01-1985 →	81506
E 250 T D	83	06/96 → 07/99	2.497	D	M	5	20	OM605.912	01-1988 →	81506
E 250 T Turbo-D	110	06/97 → 07/99	2.497	D	M	5	20	OM605.962	01-1988 →	81506
E 250 Turbo-D	110	06/97 → 07/99	2.497	D	M	5	20	OM605.962	01-1988 →	81506
E 270 CDI	120	07/99 → 03/02	2.685	D	M	5	20	OM612.961		82088
	125	07/99 → 03/02	2.685	D	M	5	20	OM612.961		82088
E 270 T CDI	120	02/00 → 03/03	2.685	D	M	5	20	OM612.961		82088
	125	07/99 → 03/03	2.685	D	M	5	20	OM612.961		82088
E 280	142	01/96 → 06/97	2.799	B	M	6	24	M104.945		81722
	150	12/96 → 03/02	2.799	B	M	6	18	M112.921		81722
E 280 4-matic	150	12/96 → 03/02	2.799	B	M	6	18	M112.921		81722
E 280 T	150	12/96 → 03/03	2.799	B	M	6	18	M112.921		81722
E 280 T 4-matic	150	12/96 → 03/03	2.799	B	M	6	18	M112.921		81722
E 290 T Turbo-D	95	06/96 → 07/99	2.874	D	M	5	10	OM602.982		81506
E 290 Turbo-D	95	03/96 → 07/99	2.874	D	M	5	10	OM602.982		81506
E 300 D	100	06/95 → 06/97	2.996	D	M	6	24	OM606.912	07-1995 →	81506
E 300 T Turbo-D	130	12/96 → 07/99	2.996	D	M	6	24	OM606.962	07-1995 →	81506
E 300 Turbo-D	130	12/96 → 07/99	2.996	D	M	6	24	OM606.962		81506
E 320	162	06/95 → 06/97	3.199	B	M	6	24	M104.992, M104.995		81722
	165	06/97 → 03/02	3.199	B	M	6	18	M112.941		81722
E 320 4-matic	165	06/97 → 03/02	3.199	B	M	6	18	M112.941		81722
E 320 CDI	145	07/99 → 03/02	3.226	D	A	6	24	OM613.961		82084
E 320 T	165	12/96 → 03/03	3.199	B	M	6	18	M112.941		81722
E 320 T 4-matic	165	12/96 → 03/03	3.199	B	M	6	18	M112.941		81722
E 320 T CDI	145	07/99 → 03/03	3.226	D	A	6	24	OM613.961		82084
E 430	205	06/97 → 03/02	4.266	B	M	8	24	M113.940		81730
E 430 4-matic	205	05/99 → 03/02	4.266	B	M	8	24	M113.940		81730
E 430 T	205	06/97 → 03/03	4.266	B	M	8	24	M113.940		81730
E 430 T 4-matic	205	05/99 → 03/03	4.266	B	M	8	24	M113.940		81730
E 55 AMG	260	08/97 → 03/02	5.439	B	M	8	24	M113.980		81730
E 55 T AMG	260	08/97 → 03/03	5.439	B	M	8	24	M113.980	01-1998 →	81730

**Classe E III (W211), Station Wagon (S211)**

E 200 CDI	75	07/02 → 12/08	2.148	D	M	4	16	OM646.951		82082
	90	07/02 → 12/08	2.148	D	M	4	16	OM646.951		82082
	100	04/06 → 12/08	2.148	D	M	4	16	OM646.820		82082
	100	04/06 → 07/09	2.148	D	M	4	16	OM646.821		82082
E 200 Kompressor	120	11/02 → 12/08	1.796	B	M	4	16	M271.941		84004
	135	04/06 → 12/08	1.796	B	M	4	16	M271.956		84004
E 200 NGT	120	03/04 → 12/08	1.796		M	4	16	M271.941		84004
E 200 T Kompressor	120	03/03 → 07/09	1.796	B	M	4	16	M271.941		84004
E 220 CDI	120	03/03 → 12/08	2.149	D	M	4	16	OM646.821		82082
	100	03/02 → 12/08	2.148	D	M	4	16	OM646.961		82082
	110	03/02 → 12/08	2.148	D	M	4	16	OM646.961		82082
	125	04/06 → 12/08	2.148	D	M	4	16	OM646.821		82082

**KW**

**cm<sup>3</sup>**

**NO. OF VALVES**

**MAGNETI MARELLI**
**MERCEDES-BENZ**
**Classe E III (W211), Station Wagon (S211)**

E 220 T CDI	120	03/03 → 07/09	2.148	D	M	4	16	OM646.821		82082
	110	03/03 → 07/09	2.148	D	M	4	16	OM646.961		82082
	125	04/06 → 07/09	2.148	D	M	4	16	OM646.821		82082
E 240	130	03/02 → 12/08	2.597	B	M	6	18	M112.913, M112.917	→ M: 036.808	81730
E 240 4-matic	130	03/03 → 12/08	2.597	B	M	6	18	M112.917		81730
E 240 T	130	03/03 → 07/09	2.597	B	M	6	18	M112.913		81730
E 240 T 4-matic	130	07/03 → 07/09	2.597	B	M	6	18	M112.917		81730
E 270 CDI	120	03/02 → 12/08	2.685	D	M	5	20	OM647.961		82082
E 270 T CDI	120	03/03 → 07/09	2.685	D	M	5	20	OM647.961		82082
E 280 CDI	140	03/05 → 12/08	2.987	D	M	6	24	OM642.920		82058
E 280 CDI 4-matic	140	03/05 → 12/08	2.987	D	M	6	24	OM642.921		82058
E 280 T CDI	140	03/05 → 07/09	2.987	D	M	6	24	OM642.920		82058
E 280 T CDI 4-matic	140	03/05 → 07/09	2.987	D	M	6	24	OM642.921		82058
E 300 BlueTEC	155	09/07 → 12/08	2.987	D	M	6	24	OM642.920		82058
E 320	165	03/02 → 12/08	3.199	B	M	6	18	M112.949		81730
E 320 4-matic	165	03/03 → 12/08	3.199	B	M	6	18	M112.954		81730
E 320 CDI	165	03/05 → 12/08	2.987	D	M	6	24	OM642.920		82058
E 320 CDI 4-matic	165	03/05 → 12/08	2.987	D	M	6	24	OM642.910		82058
E 320 T	165	03/03 → 07/09	3.199	B	M	6	18	M112.949		81730
E 320 T 4-matic	165	07/03 → 07/09	3.199	B	M	6	18	M112.954		81730
E 320 T CDI	165	03/05 → 07/09	2.987	D	M	6	24	OM642.920		82058
E 320 T CDI 4-matic	165	03/05 → 07/09	2.987	D	M	6	24	OM642.920		82058
E 500	225	03/02 → 12/08	4.966	B	M	8	24	M113.967		81730
	285	04/06 → 12/08	5.461	B	M	8	32	M273.960		81730
E 500 4-matic	225	10/03 → 12/08	4.966	B	M	8	24	M113.969		81730
	285	04/06 → 12/08	5.461	B	M	8	32	M273.962		81730
E 500 T	225	10/03 → 07/09	4.966	B	M	8	24	M113.967		81730
	285	04/06 → 07/09	5.461	B	M	8	32	M273.960		81730
E 500 T 4-matic	225	10/03 → 07/09	4.966	B	M	8	24	M113.969		81730
	285	04/06 → 07/09	5.461	B	M	8	32	M273.962		81730

**Classe E IV (W212), Station Wagon (S212), Cabrio (A207), Coupé (C207)**

E 200 CDI / BlueTEC	100	01/09 →	2.143	D	M	4	16	OM651.925		84044 <b>NEW</b>
E 200 CGI	135	08/09 →	1.796	B	M	4	16	M271.820, M271.860		84004
E 200 NGT	120	03/11 →	1.796		M	4	16	M271.958		84004
E 220 BlueTEC	130	05/15 →	2.143	D	M	4	16	OM651.924		84044 <b>NEW</b>
	130	05/14 →	2.143	D	M	4	16	OM651.911		84044 <b>NEW</b>
	130	05/14 →	2.143	D	M	4	16	OM651.924		84044 <b>NEW</b>
E 220 BlueTEC 4-matic	125	01/15 →	2.143	D	M	4	16	OM651.924		84044 <b>NEW</b>
E 220 CDI	120	07/14 →	2.143	D	M	4	16	OM651.911		84044 <b>NEW</b>
	120	01/09 →	2.143	D	M	4	16	OM651.924		84044 <b>NEW</b>
	120	02/10 →	2.143	D	M	4	16	OM651.911		84044 <b>NEW</b>
	120	08/09 →	2.143	D	M	4	16	OM651.924		84044 <b>NEW</b>
E 220 CDI / BlueTEC	125	01/09 →	2.143	D	M	4	16	OM651.924		84044 <b>NEW</b>
E 220 CDI / BlueTEC / d	125	01/10 →	2.143	D	M	4	16	OM651.911		84044 <b>NEW</b>

--	--	--	--	--	--	--	--	--	--

## MERCEDES-BENZ

### Classe E IV (W212), Station Wagon (S212), Cabrio (A207), Coupé (C207)

E 220 CDI / d	125	01/10 →	2.143	D	M	4	16	OM651.911		84044	<b>NEW</b>
E 250 CDI / BlueTEC	150	01/09 →	2.143	D	M	4	16	OM651.924		84044	<b>NEW</b>
E 250 CDI / BlueTEC / d	150	01/10 →	2.143	D	M	4	16	OM651.911		84044	<b>NEW</b>
E 250 CDI / BlueTEC 4-matic	150	01/09 →	2.143	D	M	4	16	OM651.924		84044	<b>NEW</b>
E 250 CDI / d	150	01/09 →	2.143	D	M	4	16	OM651.911		84044	<b>NEW</b>
E 250 CGI	150	01/09 →	1.796	B	M	4	16	M271.860		84004	
E 300 CDI	150	12/09 → 12/10	2.987	D	M	6	24	OM642.850		82058	
E 300 CDI / BlueTEC	170	03/11 →	2.987	D	M	6	24	OM642.850, OM642.852		82058	
E 300 Hybrid / BlueTEC Hybrid	150	12/11 →	2.143		M	4	16	OM651.924		84044	<b>NEW</b>
E 350 BlueTEC	155	01/09 →	2.987	D	M	6	24	OM642.850		82058	
E 350 CDI	170	01/10 →	2.987	D	M	6	24	OM642.836		82058	
	170	01/09 →	2.987	D	M	6	24	OM642.850		82058	
	170	11/09 →	2.987	D	M	6	24	OM642.850, OM642.852		82058	
E 350 CDI 4-matic	170	09/09 →	2.987	D	M	6	24	OM642.856		82058	

### Classe G (W460, W461), Cabrio (W463)

250 GD	62	10/87 → 12/92	2.497	D	M	5	10	OM602.930	07-1982 →, → 10-1991	81506	
	68	12/88 → 08/92	2.497	D	M	5	10	OM602.930	07-1982 →, → 10-1991	81506	
	68	02/90 →	2.497	D	M	5	10	OM602.939		81506	
	69	06/90 →	2.497	D	M	5	10	OM602.931		81506	
290 GD/G 290 D	70	04/92 →	2.874	D	M	5	10	OM602.942	01-1992 →	81506	
300 GD	83	12/90 → 09/97	2.996	D	M	6	12	OM603.931		81506	
300 GE	125	06/90 →	2.960	B	M	6	12	M103.987	01-1989 →	81507	
	128	06/90 →	2.960	B	M	6	12	M103.987	01-1989 →	81507	
	155	09/94 → 11/97	3.199	B	M	6	24	M104.996	01-1995 →	81724	
350 G Turbo-D	100	09/91 → 09/97	3.449	D	M	6	12	OM603.972	→ M: 004.348	81506	
	100	09/91 → 09/97	3.449	D	M	6	12	OM603.972	01-1997 →, M →: 004.349	81726	
350 Turbo GD	100	09/91 →	3.449	D	M	6	12	OM603.972		81506	
G 270 CDI	115	01/03 →	2.685	D	M	5	20	OM612.966		82088	
	115	10/01 →	2.685	D	M	5	20	OM612.965		82047	
G 280 CDI	135	04/09 →	2.987	D	M	6	24	OM642.884		82058	
G 290 TD	88	07/97 →	2.874	D	M	5	10	OM602.983		81506	
G 300 CDI	135	04/10 →	2.987	D	M	6	24	OM642.884		82058	
G 300 TD	130	08/96 →	2.996	D	M	6	24	OM606.964		81506	
	130	09/96 →	2.996	D	M	6	24	OM606.964		81726	
G 320	155	09/94 → 12/97	3.199	B	M	6	24	M104.996	01-1995 →	81724	
	158	07/97 →	3.199	B	M	6	18	M112.945		81724	
	158	11/97 →	3.199	B	M	6	18	M112.945		81730	
G 320 CDI	165	09/06 →	2.987	D	M	6	24	OM642.970		82059	
G 350 CDI	155	07/11 →	2.987	D	M	6	24	OM642.886		82058	

**KW**

**cm<sup>3</sup>**

**NO. OF VALVES**

**MAGNETI MARELLI**
**MERCEDES-BENZ**
**Classe G (W460, W461), Cabrio (W463)**

G 350 d	180	06/15 →	2.987	D	M	6	24	OM642.887		82058
G 36 AMG	200	01/95 →	3.606	B	M	6	24	M104.996 (AMG3,6)		81724
G 500	218	04/98 →	4.966	B	A	8	24	M113.962		81730
G 55 AMG	260	04/99 →	5.439	B	A	8	24	M113.982		81730

**Classe GL I (X164)**

GL 320 CDI / 350 BlueTEC 4-matic	155	12/09 →	2.987	D	M	6	24	OM642.820		82058
GL 320 CDI 4-matic	165	09/06 → 05/09	2.987	D	M	6	24	OM642.940		82059
GL 350 CDI 4-matic	165	05/09 →	2.987	D	M	6	24	OM642.940		82059
	195	10/10 →	2.987	D	M	6	24	OM642.822		82058

**Classe GL II (X166)**

GL 350 CDI / BlueTec 4-matic	190	07/12 →	2.987	D	M	6	24	OM642.826		82058
------------------------------	-----	---------	-------	---	---	---	----	-----------	--	-------

**Classe GLA (X156)**

GLA 180 CDI / d	80	07/14 →	1.461	D	M	4	8	OM607.951		82098
-----------------	----	---------	-------	---	---	---	---	-----------	--	-------

**Classe GLK (X204)**

200 CDI	105	07/10 →	2.143	D	M	4	16	OM651.913, OM651.916		84044	<b>NEW</b>
	120	12/08 →	2.143	D	M	4	16	OM651.916		84044	<b>NEW</b>
	125	12/08 →	2.143	D	M	4	16	OM651.916		84044	<b>NEW</b>
220 CDI 4-matic	120	12/08 →	2.143	D	M	4	16	OM651.912		84044	<b>NEW</b>
	125	12/08 →	2.143	D	M	4	16	OM651.912		84044	<b>NEW</b>
250 CDI 4-matic	150	09/09 →	2.143	D	M	4	16	OM651.912		84044	<b>NEW</b>
320 CDI 4-matic	165	06/08 →	2.987	D	M	6	24	OM642.961		82058	
350 CDI 4-matic	165	07/09 → 01/10	2.987	D	M	6	24	OM642.832		82058	
	170	02/10 → 05/10	2.987	D	M	6	24	OM642.832		82058	

**Classe M I (W163)**

ML 230	110	02/98 → 06/05	2.295	B	M	4	16	M111.977		81499
ML 270 CDI	120	12/99 → 06/05	2.685	D	M	5	20	OM612.963		82088
ML 320	160	02/98 → 08/02	3.199	B	M	6	18	M112.942		81730
ML 350	180	08/02 → 06/05	3.724	B	M	6	18	M112.970		81730
ML 350 4-matic	173	02/03 → 06/05	3.724	B	M	6	18	M112.970		81730
ML 430	200	02/98 → 06/05	4.266	B	A	8	24	M113.942		81730
ML 500	215	09/01 → 06/05	4.966	B	M	8	24	M113.964, M113.965		81730
ML 55 AMG	255	02/00 → 06/05	5.439	B	A	8	24	M113.981	→ M: M036.808	81730

**Classe M II (W164)**

ML 280 CDI 4-matic	140	07/05 → 07/09	2.987	D	M	6	24	OM642.940		82059
ML 300 CDI 4-matic	140	07/09 →	2.987	D	M	6	24	OM642.940		82059
	150	02/10 →	2.987	D	M	6	24	OM642.820		82058
ML 320 CDI 4-matic	165	07/05 → 07/09	2.987	D	M	6	24	OM642.940		82059
ML 350 CDI 4-matic	155	09/09 →	2.987	D	M	6	24	OM642.820		82058
	165	07/09 →	2.987	D	M	6	24	OM642.940		82059
	170	02/10 →	2.987	D	M	6	24	OM642.820		82059
ML 500 4-matic	225	07/05 →	4.966	B	M	8	24	M113.964		81730

--	--	--	--	--	--	--	--	--	--

## MERCEDES-BENZ

### Classe M III (166)

ML 250 CDI / BlueTEC 4-matic	150	06/11 →	2.143	D	M	4	16	OM651.960		84044	
ML 350 BlueTEC 4-matic	190	06/11 →	2.987	D	M	6	24	OM642.826		82058	

### Classe R (W251, V251)

R 280 CDI	140	05/06 →	2.987	D	M	6	24	OM642.870, OM642.872, OM642.950	→ 10-2007	82058	
	140	05/06 →	2.987	D	M	6	24	OM642.870, OM642.872, OM642.950	11-2007 →	82059	
R 280 CDI 4-matic	140	05/06 →	2.987	D	M	6	24	OM642.950	→ 10-2007	82058	
	140	05/06 →	2.987	D	M	6	24	OM642.950	11-2007 →	82059	
R 300 CDI	140	07/09 →	2.987	D	M	6	24	OM642.870, OM642.872, OM642.950		82059	
R 300 CDI 4-matic	140	07/09 →	2.987	D	M	6	24	OM642.950		82059	
R 320 CDI 4-matic	155	01/06 →	2.987	D	M	6	24	OM642.870, OM642.950		82058	
	165	01/06 →	2.987	D	M	6	24	OM642.950	→ 10-2007	82058	
	165	01/06 →	2.987	D	M	6	24	OM642.950	11-2007 →	82059	
R 350 CDI 4-matic	155	01/06 →	2.987	D	M	6	24	OM642.870, OM642.950		82059	
	165	07/09 →	2.987	D	M	6	24	OM642.950		82059	

### Classe S III (W126), Coupé (C126)

260 SE	118	09/85 → 06/91	2.597	B	M	6	12	M103.941	09-1985 →, → 06-1991, M →: 002.988	81507	
	122	09/85 → 06/91	2.597	B	M	6	12	M103.941	09-1985 →, → 06-1991, M →: 002.988	81507	
300 SE,SEL	132	01/86 → 06/91	2.960	B	M	6	12	M103.981		81507	

### Classe S IV (W140), Coupé (C140)

300 SE 2.8	145	01/93 → 10/98	2.799	B	M	6	24	M104.944		81724	
300 SE,SEL/S320	170	03/91 → 10/98	3.199	B	M	6	24	M104.990, M104.994		81724	
S 280	142	02/93 → 10/98	2.799	B	M	6	24	M104.944		81724	
S 300 Turbo-D	130	05/96 → 10/98	2.996	D	M	6	24	OM606.961		81506	
S 350 Turbo-D	110	01/93 → 10/98	3.449	D	M	6	12	OM603.971		81506	

### Classe S V (W220), Coupé (C215)

CL 500	225	03/99 → 03/06	4.966	B	A	8	24	M113.960	→ M: 036.808	81730	
CL 55 AMG	265	10/99 → 03/06	5.439	B	A	8	24	M113.986		81730	
S 280	150	10/98 → 08/05	2.799	B	M	6	18	M112.922		81730	
S 320	165	10/98 → 08/05	3.199	B	A	6	18	M112.944		81724	
S 350	180	09/02 → 08/05	3.724	B	M	6	18	M112.972		81730	
S 350 4-matic	180	06/03 → 08/05	3.724	B	M	6	18	M112.975		81730	
S 430	205	10/98 → 08/05	4.266	B	A	8	24	M113.941	→ M: 036.808	81730	
S 430 4-matic	205	09/02 → 08/05	4.266	B	A	8	24	M113.948		81730	
S 500	225	10/98 → 08/05	4.966	B	A	8	24	M113.960, M113.966		81499	
S 500 4-matic	225	09/02 → 08/05	4.966	B	A	8	24	M113.966		81730	



## MERCEDES-BENZ

### Classe S V (W220), Coupé (C215)

S 55 AMG	265	04/99 → 08/05	5.439	B	A	8	24	M113.986		81730
----------	-----	---------------	-------	---	---	---	----	----------	--	-------

### Classe S VI (W221), Coupé (C216)

S 250 CDI	150	01/11 → 12/13	2.143	D	M	4	16	OM651.961		84044 <b>NEW</b>
S 320 CDI	155	10/05 → 12/13	2.987	D	M	6	24	OM642.930		82058
	173	12/05 → 06/09	2.987	D	M	6	24	OM642.930		82059
S 320 CDI 4-matic	155	10/05 → 12/13	2.987	D	M	6	24	OM642.932		82058
	173	10/06 → 12/13	2.987	D	M	6	24	OM642.932		82059
S 350 BlueTec	190	04/11 → 12/13	2.987	D	M	6	24	OM642.862		82058
S 350 BlueTEC 4-matic	190	04/11 → 12/13	2.987	D	M	6	24	OM642.868		82058
S 350 CDI	173	06/09 → 12/13	2.987	D	M	6	24	OM642.930		82058

### Classe V

V 200	95	02/97 → 07/03	1.998	B	M	4	16	M111.948, M111.950	→ M: 002.353	81728
	95	02/97 → 07/03	1.998	B	M	4	16	M111.948, M111.950	M → : 002.354	81729
V 200 CDI	75	03/99 → 07/03	2.151	D	M	4	16	OM611.980		82030
V 220 CDI	90	03/99 → 07/03	2.151	D	M	4	16	OM611.980		82030
V 230	105	10/96 → 07/03	2.295	B	M	4	16	M111.978	→ M: 001.594	81728
	105	10/96 → 07/03	2.295	B	M	4	16	M111.978	M → : 001.595	81729
V 230 TD	72	09/96 → 07/03	2.299	D	M	4	8	OM601.970		81506
V 280	128	08/97 → 07/03	2.792	B	M	6	12	M104.900		81773

### CLK I (C208), Cabrio (A208)

200	100	03/98 → 03/02	1.998	B	M	4	16	M111.941, M111.945		81725
	100	06/97 → 06/02	1.998	B	M	4	16	M111.945		81499
200 Kompressor	120	06/00 → 06/02	1.998	B	M	4	16	M111.956		81725
	141	06/97 → 06/00	1.998	B	M	4	16	M111.944		81725
		03/98 → 06/00	1.998	B	M	4	16	M111.944		81724
230 Kompressor	142	06/97 → 06/00	2.295	B	M	4	16	M111.973, M111.975		81725
	145	06/00 → 06/02	2.295	B	M	4	16	M111.982		81725
320	160	06/97 → 06/02	3.199	B	M	6	18	M112.940		81730
	160	03/98 → 03/02	3.199	B	A	6	18	M112.940		81730
430	205	07/98 → 06/02	4.266	B	A	8	24	M113.943		81730
55 AMG	255	08/99 → 06/02	5.439	B	M	8	24	M113.981, M113.984		81730

### CLK II (C209), Cabrio (A209)

200 CGI	125	07/03 → 05/09	1.796	B	M	4	16	M271.942		84004
200 Kompressor	120	09/02 → 05/09	1.796	B	M	4	16	M271.940		84004
	135	10/06 → 05/09	1.796	B	M	4	16	M271.955		84004
220 CDI	100	01/05 → 05/09	2.148	D	M	4	16	OM646.966		82082
	110	01/05 → 05/09	2.148	D	M	4	16	OM646.966		82082
240	120	06/02 → 05/09	2.597	B	M	6	18	M112.912		81730
	125	06/02 → 05/09	2.597	B	M	6	18	M112.912		81730
270 CDI	120	02/03 → 06/05	2.685	D	M	5	20	OM612.967		82088
	125	10/02 → 05/09	2.685	D	M	5	20	OM612.962, OM612.967		82088
320	160	06/02 → 05/09	3.199	B	A	6	18	M112.955		81730
320 CDI	165	01/05 → 05/09	2.987	D	M	6	24	OM642.910		82058
500	225	06/02 → 05/09	4.966	B	A	8	24	M113.968		81730



		KW		cm <sup>3</sup>				NO. OF VALVES		
--	--	----	--	-----------------	--	--	--	---------------	--	--

## MERCEDES-BENZ

### CLK II (C209), Cabrio (A209)

55 AMG	270	09/02 → 05/09	5.439	B	A	8	24	M113.987		81730
CLK 200 CGI	125	07/03 → 03/10	1.796	B	M	4	16	M271.942		81725
CLK 200 Kompressor	120	02/03 → 03/10	1.796	B	M	4	16	M271.940		84004
	135	10/06 → 03/10	1.796	B	M	4	16	M271.955		84004
CLK 240	125	02/03 → 03/10	2.597	B	M	6	18	M112.912		81730
CLK 320	160	02/03 → 03/10	3.199	B	M	6	18	M112.955		81730
CLK 320 CDI	165	03/05 → 03/10	2.987	D	M	6	24	OM642.910		82058
CLK 500	225	02/03 → 03/10	4.966	B	M	8	24	M113.968		81730
CLK 55 AMG	270	02/03 → 03/10	5.439	B	M	8	24	M113.987		81730
CLK AMG DTM	428	06/04 → 03/10	5.439	B	M	8	24	M113.994		81730
DTM AMG	428	06/04 → 05/09	5.439	B	M	8	24	M113.994		81730

### CLS I (C219)

CLS 320 CDI	155	01/05 → 12/10	2.987	D	M	6	24	OM642.920		82058
	165	01/05 → 12/10	2.987	D	M	6	24	OM642.920		82058
CLS 350 CDI	200	04/09 → 12/10	2.987	D	M	6	24	OM642.920		82058
	165	04/09 → 12/10	2.987	D	M	6	24	OM642.920		82058
CLS 500	225	10/04 → 12/10	4.966	B	M	8	24	M113.967		81730

### CLS II (C218), Shooting Brake (X218)

CLS 220 BlueTEC	130	05/14 →	2.143	D	M	4	16	OM651.924		84044	
CLS 220 BlueTEC / d	120	05/14 →	2.143	D	M	4	16	OM651.924		84044	
	125	05/14 →	2.143	D	M	4	16	OM651.924		84044	
CLS 250 BlueTEC / d 4-matic	150	05/14 →	2.143	D	M	4	16	OM651.924		84044	
CLS 250 CDI / BlueTEC / d	150	04/11 →	2.143	D	M	4	16	OM651.924		84044	

### Coupé III (C124)

220 CE	110	10/92 → 05/93	2.199	B	M	4	16	M111.960		81499
230 CE	97	03/87 → 12/92	2.298	B	M	4	8	M102.982		81509
	100	03/87 → 12/92	2.298	B	M	4	8	M102.982		81509
300 CE	132	03/87 → 05/93	2.960	B	M	6	12	M103.983	M →: 018.293	81507
320 CE	162	10/92 → 05/93	3.199	B	M	6	24	M104.992		81722

### Kombi II (S124)

200 T	77	01/86 → 05/90	1.996	B	M	4	8	M102.922		81509
200 T D	53	09/85 → 08/91	1.997	D	M	4	8	OM601.912	01-1985 →, → 05-1993	81504
	55	09/88 → 08/91	1.997	D	M	4	8	OM601.912	01-1985 →, → 05-1993	81504
200 TE	87	09/88 → 08/92	1.996	B	M	4	8	M102.963		81509
	110	10/92 → 05/93	2.199	B	M	4	16	M111.960		81499
230 TE	97	09/85 → 08/92	2.298	B	M	4	8	M102.982		81509
	100	09/85 → 08/92	2.298	B	M	4	8	M102.982		81509
250 T D	66	09/85 → 06/93	2.497	D	M	5	10	OM602.912	→ M: 033.729	81506
	66	09/85 → 06/93	2.497	D	M	5	10	OM602.912	M →: 033.730	81726
	69	01/89 → 06/93	2.497	D	M	5	10	OM602.912		81506

**KW**

**cm<sup>3</sup>**

**NO. OF VALVES**

**MAGNETI MARELLI**
**MERCEDES-BENZ**
**Kombi II (S124)**

280 TE	145	10/92 → 06/93	2.799	B	M	6	24	M104.942		81722
300 T D	80	09/86 → 06/93	2.996	D	M	6	12	OM603.912	01-1985 →	81506
	81	01/89 → 06/93	2.996	D	M	6	12	OM603.912	01-1985 →	81506
	83	01/89 → 06/93	2.996	D	M	6	12	OM603.912	01-1985 →	81506
300 T Turbo-D	108	01/89 → 06/93	2.996	D	M	6	12	OM603.960	01-1987 →	81506
300 T Turbo-D 4-matic	108	01/89 → 06/93	2.996	D	M	6	12	OM603.960	01-1987 →	81506
300 TE	132	01/86 → 08/92	2.960	B	M	6	12	M103.983	M →: 018.293	81507
300 TE 4-matic	132	09/86 → 06/93	2.960	B	M	6	12	M103.985	01-1985 →, → 05-1996, M →: 094.339	81507
320 TE	162	10/92 → 06/93	3.199	B	M	6	24	M104.992		81722

**Saloon (W124)**

200	77	01/86 → 05/90	1.996	B	M	4	8	M102.922		81509
	75	01/86 → 05/90	1.996	B	M	4	8	M102.922		81509
	80	12/85 → 05/90	1.996	B	M	4	8	M102.922		81509
200 D	55	08/89 → 06/93	1.997	D	M	4	8	OM601.912		81504
200 E	87	09/88 → 08/92	1.996	B	M	4	8	M102.963		81509
	100	10/92 → 06/93	1.998	B	M	4	16	M111.940		81499
220 E	110	10/92 → 06/93	2.199	B	M	4	16	M111.960		81499
230 E	97	12/84 → 06/93	2.298	B	M	4	8	M102.982		81509
	100	01/85 → 06/93	2.298	B	M	4	8	M102.982		81509
250 D	66	04/85 → 06/93	2.497	D	M	5	10	OM602.912		81506
	69	01/89 → 06/93	2.497	D	M	5	10	OM602.912		81506
250 Turbo-D	93	09/88 → 06/93	2.497	D	M	5	10	OM602.962	01-1985 →	81506
260 E	118	09/85 → 08/92	2.597	B	M	6	12	M103.940	M →: 016.912	81507
260 E 4-matic	118	09/86 → 08/92	2.597	B	M	6	12	M103.943	01-1985 →, → 05-1996, M →: 035.732	81507
280 E	145	10/92 → 06/93	2.799	B	M	6	24	M104.942	01-1993 →	81722
300 D	81	06/90 → 06/93	2.996	D	M	6	12	OM603.912	01-1985 →	81506
	83	08/89 → 06/93	2.996	D	M	6	12	OM603.912	→ M: 054.122	81506
	83	08/89 → 06/93	2.996	D	M	6	12	OM603.912	M →: 054.123	81726
300 D 4-matic	80	09/86 → 08/92	2.996	D	M	6	12	OM603.913	01-1985 →	81506
	83	08/89 → 06/93	2.996	D	M	6	12	OM603.913	01-1985 →	81506
300 E	138	01/85 → 08/92	2.960	B	M	6	12	M103.980, M103.983	01-1985 →, → 05-1996, M →: 018.293, → M: 018.293	81507
	132	08/85 → 08/92	2.960	B	M	6	12	M103.983	M →: 018.293	81507

**KW**

**cm<sup>3</sup>**

**NO. OF VALVES**

**MERCEDES-BENZ**
**Saloon (W124)**

300 E 4-matic	138	09/86 → 02/92	2.960	B	M	6	12	M103.983	01-1985 →, → 05-1993, M →: 094.339	81507
	132	09/86 → 06/93	2.960	B	M	6	12	M103.985	02-1985 →, → 05-1993, M →: 094.339	81507
300 Turbo-D	108	09/88 → 06/93	2.996	D	M	6	12	OM603.960	01-1987 →	81506
300 Turbo-D 4-matic	108	01/88 → 06/93	2.996	D	M	6	12	OM603.963	01-1987 →	81506
320 E	162	10/92 → 06/93	3.199	B	M	6	24	M104.992		81722

**SL III (R129)**

280	142	08/93 → 10/01	2.799	B	M	6	24	M104.943	09-1994 →	81722
	150	05/98 → 10/01	2.799	B	M	6	18	M112.923, M112.925		81722
300 SL	140	03/89 → 08/93	2.960	B	M	6	12	M103.984	06-1989 →, → 09-1993	81507
320	165	05/98 → 10/01	3.199	B	A	6	18	M112.943		81730
	170	09/93 → 10/01	3.199	B	M	6	24	M104.991		81724

**SL IV (R230)**

350	180	03/03 → 01/12	3.724	B	M	6	18	M112.973		81730
500	225	10/01 → 01/12	4.966	B	M	8	24	M113.963	→ M: 036.808	81730

**SLC (R172)**

250 d	150	01/16 →	2.143	D	M	4	16	OM651.980		84044 <b>NEW</b>
-------	-----	---------	-------	---	---	---	----	-----------	--	------------------

**SLK I (R170)**

200	100	09/96 → 03/00	1.998	B	M	4	16	M111.946		81499
200 Kompressor	141	10/96 → 03/00	1.998	B	M	4	16	M111.943		81725
230 Kompressor	142	09/96 → 03/00	2.295	B	M	4	16	M111.973		81725
320	160	03/00 → 04/04	3.199	B	AM	6	18	M112.947		81730

**SLK II (R171)**

200 Kompressor	120	03/04 → 02/11	1.795	B	M	4	16	M271.944		84004
	135	01/08 → 02/11	1.796	B	M	4	16	M271.954		84004

**SLK III (R172)**

200	135	02/11 →	1.796	B	M	4	16	M271.860, M271.861		84004
250	150	02/11 →	1.796	B	M	4	16	M271.860, M271.861		84004
250 CDI / d	150	01/12 →	2.143	D	M	4	16	OM651.980		84044 <b>NEW</b>

**Sprinter I (901, 902, 903, 904)**

208 CDI	60	04/00 → 05/06	2.148	D	M	4	16	OM611.987		82047
208 D	58	02/95 → 04/00	2.299	D	M	4	8	OM601.943	01-1996 →	81774
	58	02/95 → 04/00	2.299	D	M	4	8	OM601.943		81506
	60	10/96 → 04/00	2.299	D	M	4	8	OM601.943	01-1996 →	81774
	75	03/97 → 04/00	2.874	D	M	5	10	OM602.980	12-1994 →	81506
211 CDI	80	04/00 → 05/06	2.148	D	M	4	16	OM611.981	→ M: 107859	82047
212 D	90	02/95 → 04/00	2.874	D	M	5	10	OM602.980	12-1994 →	81506
	90	02/95 → 04/00	2.874	D	M	5	10	OM602.980		81506
213 CDI	95	04/00 → 05/06	2.148	D	M	4	16	OM611.981		82047
214	105	02/95 → 05/06	2.295	B	M	4	16	M111.979, M111.984	01-1996 →	81774

**KW**

**cm<sup>3</sup>**

**NO. OF VALVES**

**MAGNETI MARELLI**
**MERCEDES-BENZ**
**Sprinter I (901, 902, 903, 904)**

214 NGT	92	04/00 → 05/06	2.295		M	4	16	M111.984		81774
216 CDI	115	04/00 → 05/06	2.685	D	M	5	20	OM612.981	→ 01-2004	82047
308 CDI	60	04/00 → 05/06	2.148	D	M	4	16	OM611.987		82047
308 D	58	02/95 → 04/00	2.299	D	M	4	8	OM601.943	01-1996 →	81774
	60	03/97 → 04/00	2.299	D	M	4	8	OM601.943		81506
308 D 2.3	58	02/95 → 04/00	2.299	D	M	4	8	OM601.943	01-1996 →	81774
	60	02/95 → 04/00	2.299	D	M	4	8	OM601.943	→ 04-1995	81506
	60	02/95 → 04/00	2.299	D	M	4	8	OM601.943		82047
	60	11/96 → 04/00	2.299	D	M	4	8	OM601.943	01-1996 →	81774
310 D	75	01/97 → 12/99	2.874	D	M	5	10	OM602.980		81506
310 D 2.9	75	02/95 → 04/00	2.874	D	M	5	10	OM602.980	12-1994 →	81506
310 D 4x4	75	05/97 → 08/02	2.874	D	M	5	10	OM602.980	12-1994 →	81506
311 CDI	80	04/00 → 05/06	2.148	D	M	4	16	OM611.981	→ M: 107859	82047
311 CDI 4x4	80	08/02 → 05/06	2.148	D	M	4	16	OM611.981	→ M: 107859	82047
312 D 2.9	90	02/95 → 04/00	2.874	D	M	5	10	OM602.980	12-1994 →	81506
	90	02/95 → 04/00	2.874	D	M	5	10	OM602.980		81506
312 D 2.9 4x4	90	05/97 → 08/02	2.874	D	M	5	10	OM602.980	12-1994 →	81506
	90	05/97 → 08/02	2.874	D	M	5	10	OM602.980		81506
313 CDI	95	04/00 → 05/06	2.148	D	M	4	16	OM611.981		82047
313 CDI 4x4	95	08/02 → 05/06	2.148	D	M	4	16	OM611.981		82047
314	105	02/95 → 05/06	2.295	B	M	4	16	M111.979, M111.984	01-1996 →	81774
	105	02/95 → 05/06	2.295	B	M	4	16	M111.984	01-1996 →	81774
314 4x4	105	08/02 → 05/06	2.295	B	M	4	16	M111.984		81774
314 NGT	92	04/00 → 05/06	2.295		M	4	16	M111.984		81774
	92	04/00 → 05/06	2.295		M	4	8			81774
316 CDI	115	04/00 → 05/06	2.685	D	M	5	20	OM612.981	→ 01-2004	82047
316 CDI 4x4	115	08/02 → 05/06	2.685	D	M	5	20	OM612.981	→ 01-2004	82047
408 CDI	60	04/00 → 05/06	2.148	D	M	4	16	OM611.987		82047
408 D	58	02/96 → 05/06	2.299	D	M	4	8	OM601.943	01-1996 →	81774
410 D	75	02/96 → 05/06	2.874	D	M	5	10	OM602.980	12-1994 →	81506
410 D 4x4	75	05/97 → 05/06	2.874	D	M	5	10	OM602.980	12-1994 →	81506
411 CDI	80	04/00 → 05/06	2.148	D	M	4	16	OM611.981	→ M: 107859	82047
411 CDI 4x4	80	04/00 → 05/06	2.148	D	M	4	16	OM611.981	→ M: 107859	82047
412 D	85	02/96 → 05/06	2.874	D	M	5	10	OM602.980	12-1994 →	81506
	90	02/96 → 05/06	2.874	D	M	5	10	OM602.980	12-1994 →	81506
412 D 4x4	85	05/97 → 05/06	2.874	D	M	5	10	OM602.980	12-1994 →	81506
	90	05/97 → 05/06	2.874	D	M	5	10	OM602.980	12-1994 →	81506
413 CDI	95	04/00 → 05/06	2.148	D	M	4	16	OM611.981		82047
413 CDI 4x4	95	04/00 → 05/06	2.148	D	M	4	16	OM611.981		82047
414	105	02/96 → 05/06	2.295	B	M	4	16	M111.979, M111.984	01-1996 →	81774
	105	02/96 → 05/06	2.295	B	M	4	16	M111.979, M111.984		81774
414 4x4	105	05/97 → 05/06	2.295	B	M	4	16	M111.979, M111.984	01-1996 →	81774
416 CDI	115	04/00 → 05/06	2.685	D	M	5	20	OM612.981	→ 01-2004	82047
416 CDI 4x4	115	04/00 → 05/06	2.685	D	M	5	20	OM612.981	→ 01-2004	82047

--	--	--	--	--	--	--	--	--	--

## MERCEDES-BENZ

### Sprinter II (905)

616 CDI	115	04/01 → 05/06	2.685	D	M	5	20	OM612.981	82047
---------	-----	---------------	-------	---	---	---	----	-----------	-------

### Sprinter III (906)

209 CDI	65	06/06 →	2.148	D	M	4	16	OM646.984	82052
210 CDI	70	03/09 →	2.143	D	M	4	16	OM651.955	84025 <b>NEW</b>
211 CDI	80	06/06 →	2.148	D	M	4	16	OM646.985	82052
213 CDI	95	06/06 →	2.143	D	M	4	16	OM651.955, OM651.956	84025 <b>NEW</b>
	95	03/09 →	2.143	D	M	4	16	OM651.956	84025 <b>NEW</b>
	95	06/06 →	2.148	D	M	4	16	OM646.986	82052
215 CDI	110	06/06 →	2.148	D	M	4	16	OM646.986, OM646.989, OM646.990	82052
	110	06/06 →	2.148	D	M	4	16	OM646.989, OM646.990	82052
216	115	09/08 →	1.796	B	M	4	16	M271.951	84002
216 CDI	120	06/06 →	2.143	D	M	4	16	OM651.955, OM651.957	84025 <b>NEW</b>
	120	03/09 →	2.143	D	M	4	16	OM651.957	84025 <b>NEW</b>
218 CDI	135	06/06 →	2.987	D	M	6	24	OM642.896, OM642.992	82058
	135	06/06 →	2.987	D	M	6	24	OM642.896, OM642.992, OM642.993	82052
219 CDI / BlueTEC	140	03/09 →	2.987	D	M	6	24	OM642.896, OM642.992	82058
224	190	06/06 →	3.498	B	M	6	24	M272.979	82052
309 CDI	65	06/06 →	2.148	D	M	4	16	OM646.984	82052
310 CDI	70	03/09 →	2.143	D	M	4	16	OM651.955	84025 <b>NEW</b>
	70	03/09 →	2.143	D	M	4	16	OM651.955, OM651.956	84025 <b>NEW</b>
311 CDI	80	06/06 →	2.148	D	M	4	16	OM646.985	82052
311 CDI 4x4	80	02/08 →	2.148	D	M	4	16	OM646.985	82052
313 CDI	95	08/11 →	2.143	D	M	4	16	OM651.955, OM651.956	84025 <b>NEW</b>
	95	06/06 →	2.148	D	M	4	16	OM646.986	82052
	95	06/06 →	2.148	D	M	4	16	OM646.986, OM651.955	82052
313 CDI 4x4	95	08/11 →	2.143	D	M	4	16	OM651.955, OM651.956	84025 <b>NEW</b>
315 CDI	110	06/06 →	2.148	D	M	4	16	OM646.989, OM646.990	82052
315 CDI 4x4	110	02/08 →	2.148	D	M	4	16	OM646.989, OM646.990	82052
316	115	09/08 →	1.796	B	M	4	16	M271.951	84002
316 CDI	120	08/11 →	2.143	D	M	4	16	OM651.955, OM651.957	84025 <b>NEW</b>
	120	03/09 →	2.143	D	M	4	16	OM651.957	84025 <b>NEW</b>
316 CDI 4x4	120	08/11 →	2.143	D	M	4	16	OM651.955, OM651.957	84025 <b>NEW</b>
316 LGT	115	09/08 →	1.796		M	4	16	M271.951	84002
	115	09/08 →	1.796		M	4	16	M271.951	84002
316 NGT	115	09/08 →	1.796		M	4	16	M271.951	84002
318 CDI	135	06/06 →	2.987	D	M	6	24	OM642.896, OM642.992, OM642.993	82052
	135	02/08 →	2.987	D	M	6	24	OM642.896, OM642.992, OM642.993	82058
318 CDI 4x4	135	02/08 →	2.987	D	M	6	24	OM642.896, OM642.992, OM642.993	82058

**KW**

**cm<sup>3</sup>**

**NO. OF VALVES**

**MAGNETI MARELLI**
**MERCEDES-BENZ**
**Sprinter III (906)**

319 CDI / BlueTEC	140	03/09 →	2.987	D	M	6	24	OM642.896, OM642.898, OM642.992		82058
319 CDI / BlueTEC 4x4	140	03/09 →	2.987	D	M	6	24	OM642.896, OM642.898, OM642.992		82058
324	190	06/06 →	3.498	B	M	6	24	M272.979		82052
411 CDI	80	06/09 →	2.148	D	M	4	16	OM646.985		82052
413 CDI	95	06/06 →	2.148	D	M	4	16	OM646.986		84025 <b>NEW</b>
415 CDI	110	06/06 →	2.148	D	M	4	16	OM646.989, OM646.990		82052
416 CDI	120	03/09 →	2.143	D	M	4	16	OM651.957		84025 <b>NEW</b>
418 CDI	135	06/09 →	2.987	D	M	6	24	OM642.896, OM642.992		82058
	135	06/06 →	2.987	D	M	6	24	OM642.896, OM642.992, OM642.993		82058
419 CDI	140	03/09 →	2.987	D	M	6	24	OM642.896, OM642.898, OM642.992		82058
	140	03/09 →	2.987	D	M	6	24	OM642.992		82058
509 CDI	65	06/06 →	2.148	D	M	4	16	OM646.984		82052
510 CDI	70	03/09 →	2.143	D	M	4	16	OM651.955		84025 <b>NEW</b>
511 CDI	80	06/06 →	2.148	D	M	4	16	OM646.985		82052
511 CDI 4x4	80	06/06 →	2.148	D	M	4	16	OM646.985		82052
513 CDI	95	06/06 →	2.143	D	M	4	16	OM651.955, OM651.956		84025 <b>NEW</b>
	95	06/06 →	2.143	D	M	4	16	OM651.956		84025 <b>NEW</b>
	95	06/06 →	2.148	D	M	4	16	OM646.986		84025 <b>NEW</b>
513 CDI 4x4	95	05/11 →	2.143	D	M	4	16	OM651.955, OM651.956		84025 <b>NEW</b>
	95	06/06 →	2.143	D	M	4	16	OM651.956		84025 <b>NEW</b>
515 CDI	110	06/06 →	2.148	D	M	4	16	OM646.986, OM646.989, OM646.990		82052
	110	06/06 →	2.148	D	M	4	16	OM646.989, OM646.990		82052
515 CDI 4x4	110	06/06 →	2.148	D	M	4	16	OM646.989, OM646.990		82052
516	115	09/08 →	1.796	B	M	4	16	M271.951		84002
516 CDI	120	03/09 →	2.143	D	M	4	16	OM651.955, OM651.957		84025 <b>NEW</b>
516 CDI 4x4	120	06/06 →	2.143	D	M	4	16	OM651.955, OM651.957		84025 <b>NEW</b>
516 NGT	115	09/08 →	1.796		M	4	16	M271.951		84002
518 CDI	135	06/06 →	2.987	D	M	6	24	OM642.896, OM642.992, OM642.993		82058
	135	06/06 →	2.987	D	M	6	24	OM642.896, OM642.992, OM642.993		82052
518 CDI 4x4	135	06/06 →	2.987	D	M	6	24	OM642.896, OM642.992, OM642.993		82058
519 CDI / BlueTEC	140	03/09 →	2.987	D	M	6	24	OM642.896, OM642.898, OM642.992		82058
519 CDI / BlueTEC 4x4	140	03/09 →	2.987	D	M	6	24	OM642.896, OM642.898, OM642.992		82058

--	--	--	--	--	--	--	--	--	--

## MERCEDES-BENZ

### Sprinter IV Classic

311 CDI	80	09/13 →	2.148	D	M	4	16	OM646.701		82052
411 CDI	80	09/13 →	2.148	D	M	4	16	OM646.701		82052

### T1

207 D 2.4	53	07/82 → 01/90	2.376	D	M	4	8			81508
	53	06/82 → 01/90	2.399	D	M	4	8	OM616.937, OM616.939		81508
208 D 2.3	58	10/88 → 02/96	2.299	D	M	4	8	OM601.940		81506
	60	10/88 → 02/96	2.299	D	M	4	8	OM601.940	02-1988 →, → 04-1995	81506
	60	06/89 → 02/96	2.299	D	M	4	8	OM601.940		81506
210 D 2.8	70	11/88 → 02/96	2.874	D	M	5	10	OM602.940	01-1983 →	81506
	72	11/88 → 02/96	2.874	D	M	5	10	OM602.940	01-1983 →	81506
	72	11/88 → 02/96	2.874	D	M	5	10	OM602.940		81506
210 D 2.9	70	11/88 → 02/96	2.874	D	M	5	10	OM602.940		81506
307 D 2.4	53	10/82 → 01/90	2.399	D	M	4	8	OM616.937, OM616.939		81508
308 D 2.3	58	05/90 → 02/96	2.299	D	M	4	8	OM601.940	01-1983 →, → 04-1995	81506
	60	06/89 → 02/96	2.299	D	M	4	8	OM601.940	01-1983 →, → 04-1995	81506
310 D 2.9	70	06/89 → 02/96	2.874	D	M	5	10	OM602.940	01-1983 →	81506
	70	06/89 → 02/96	2.874	D	M	5	10	OM602.940		81506
310 D 2.9	72	06/89 → 02/96	2.874	D	M	5	10	OM602.940		81506
	72	06/90 → 02/96	2.874	D	M	5	10	OM602.940	01-1983 →	81506

### Vaneo

1.6	60	02/02 → 07/05	1.598	B	M	4	8	M166.961		82087
	75	02/02 → 07/05	1.598	B	M	4	8	M166.961		82087
1.7 CDI	55	02/02 → 07/05	1.689	D	M	4	16	OM668.914		82087
	67	02/02 → 07/05	1.689	D	M	4	16	OM668.914		82087
1.9	92	02/02 → 07/05	1.898	B	M	4	8	M166.991		82087

### Vario

512 D	90	09/96 →	2.874	D	M	5	10	OM602.984		81506
612 D	90	09/96 →	2.874	D	M	5	10	OM602.984, OM602.985		81506
812 D	90	09/96 →	2.874	D	M	5	10	OM602.984, OM602.985		81506
O 812	90	09/96 →	2.874	D	M	5	10	OM602.984, OM602.985		81506

### Vito I (W638)

108 CDI 2.2	60	03/99 → 07/03	2.148	D	M	4	16	OM611A (60KWCDI)		82030
	60	03/99 → 07/03	2.151	D	M	4	16	OM611A (60KWCDI)		82030
108 D 2.3	58	02/96 → 07/03	2.299	D	M	4	8	OM601.942		81506
	58	03/97 → 07/03	2.299	D	M	4	8	OM601.942	11-1995 →	81506
110 CDI 2.2	75	03/99 → 07/03	2.148	D	M	4	16	OM611LA (75KWCDI)		82030
	75	03/99 → 07/03	2.151	D	M	4	16	OM611LA (75KWCDI)		82030
110 D 2.3	72	03/97 → 07/03	2.299	D	M	4	8	OM601.970	11-1995 →	81506
110 TD 2.3	72	02/96 → 07/03	2.299	D	M	4	8	OM601.970		81506
112 CDI 2.2	90	03/99 → 07/03	2.151	D	M	4	16	OM611.980		82030



KW



cm<sup>3</sup>



NO. OF VALVES



MAGNETI MARELLI

## MERCEDES-BENZ

### Vito I (W638)

113 2.0	95	02/96 → 07/03	1.998	B	M	4	16	M111.948, M111.950	→ M: 002.353	81728
	95	02/96 → 07/03	1.998	B	M	4	16	M111.948, M111.950	M → : 002.354	81729
114 2.3	105	12/96 → 07/03	2.295	B	M	4	16	M111.978, M111.980	→ M: 001.954	81728
	105	12/96 → 07/03	2.295	B	M	4	16	M111.978, M111.980	M → : 001.595	81729
	105	03/97 → 07/03	2.295	B	M	4	16	M111.978, M111.980	→ M: 001.594	81728

### Vito II (W639) - Viano

109 CDI	65	09/03 →	2.148	D	M	4	16	OM646.983		82052
	70	09/06 →	2.148	D	M	4	16	OM646.980		82052
	70	08/06 →	2.148	D	M	4	16	OM646.980, OM646.981		82052
109 CDI 4x4	70	09/07 →	2.148	D	M	4	16	OM646.981		82052
110 CDI	70	09/10 →	2.143	D	M	4	16	OM651.940	Potenziata	84048 <b>NEW</b>
	70	09/10 →	2.143	D	M	4	16	OM651.940		84046 <b>NEW</b>
	70	09/10 →	2.143	D	M	4	16	OM651.940		84047 <b>NEW</b>
111 CDI	80	09/03 →	2.148	D	M	4	16	OM646.982		82052
	85	09/07 →	2.148	D	M	4	16	OM646.980, OM646.982		82052
	85	09/07 →	2.148	D	M	4	16	OM646.980		82052
111 CDI 4x4	80	09/07 →	2.148	D	M	4	16	OM646.982		82052
113 CDI	100	09/10 →	2.143	D	M	4	16	OM651.940	Potenziata	84048 <b>NEW</b>
	100	09/10 →	2.143	D	M	4	16	OM651.940		84046 <b>NEW</b>
	100	09/10 →	2.143	D	M	4	16	OM651.940		84047 <b>NEW</b>
113 CDI 4x4	100	09/10 →	2.143	D	M	4	16	OM651.940	Potenziata	84048 <b>NEW</b>
	100	09/10 →	2.143	D	M	4	16	OM651.940		84046 <b>NEW</b>
	100	09/10 →	2.143	D	M	4	16	OM651.940		84047 <b>NEW</b>
115 CDI	110	09/03 →	2.148	D	M	4	16	OM646.980, OM646.982		82052
	110	09/03 →	2.148	D	M	4	16	OM646.982		82052
115 CDI 4x4	110	07/06 →	2.148	D	M	4	16	OM646.982		82052
116 CDI	120	09/10 →	2.143	D	M	4	16	OM651.940	Potenziata	84048 <b>NEW</b>
	120	09/10 →	2.143	D	M	4	16	OM651.940		84046 <b>NEW</b>
	120	09/10 →	2.143	D	M	4	16	OM651.940		84047 <b>NEW</b>
116 CDI 4x4	120	09/10 →	2.143	D	M	4	16	OM651.940	Potenziata	84048 <b>NEW</b>
	120	09/10 →	2.143	D	M	4	16	OM651.940		84046 <b>NEW</b>
	120	09/10 →	2.143	D	M	4	16	OM651.940		84047 <b>NEW</b>
119	140	09/03 →	3.199	B	M	6	18	M112.951		81730
120 CDI	150	07/06 →	2.987	D	M	6	24	OM642.990		82058
122	160	09/03 →	3.199	B	M	6	18	M112.951		81730
122 CDI	165	09/10 →	2.987	D	M	6	24	OM642.890		82058
123	170	06/04 →	3.724	B	M	6	18	M112.976	→ M: 31.000.000	81730
	170	06/04 → 07/08	3.724	B	M	6	18	M112.976	→ M: 31.000.000	81730
3.0	140	09/03 →	3.199	B	M	6	18	M112.951		81730
3.2	160	09/03 →	3.199	B	M	6	18	M112.951		81730
3.7	170	06/04 →	3.724	B	M	6	18	M112.976	→ M: 31.000.000	81730



--	--	--	--	--	--	--	--	--	--

## MERCEDES-BENZ

### Vito II (W639) - Viano

CDI 2.0	100	07/10 →	2.143	D	M	4	16	OM651.940	Potenziata	84048	
	100	07/10 →	2.143	D	M	4	16	OM651.940		84046	
	100	07/10 →	2.143	D	M	4	16	OM651.940		84047	
	80	09/03 →	2.148	D	M	4	16	OM646.982		82052	
	85	08/05 →	2.148	D	M	4	16	OM646.982		82052	
CDI 2.0 4-matic	100	07/10 →	2.143	D	M	4	16	OM651.940	Potenziata	84048	
	100	07/10 →	2.143	D	M	4	16	OM651.940		84046	
	100	07/10 →	2.143	D	M	4	16	OM651.940		84047	
	80	07/05 →	2.148	D	M	4	16	OM646.982		82052	
CDI 2.2	120	07/10 →	2.143	D	M	4	16	OM651.940	Potenziata	84048	
	120	07/10 →	2.143	D	M	4	16	OM651.940		84046	
	120	07/10 →	2.143	D	M	4	16	OM651.940		84047	
	110	09/03 →	2.148	D	M	4	16	OM646.980, OM646.982		82052	
CDI 2.2 4-matic	120	07/10 →	2.143	D	M	4	16	OM651.940	Potenziata	84048	
	120	07/10 →	2.143	D	M	4	16	OM651.940		84046	
	120	07/10 →	2.143	D	M	4	16	OM651.940		84047	
	110	07/05 →	2.148	D	M	4	16	OM646.982		82052	
CDI 3.0	150	03/06 →	2.987	D	M	6	24	OM642.990		82058	
	165	07/10 →	2.987	D	M	6	24	OM642.990		82058	

### Vito III (W447)

109 CDI	65	10/14 →	1.598	D	M	4	16	OM622.951		84034	
109 CDI / 109 BlueTEC	65	10/14 →	1.598	D	M	4	16	OM622.951		84034	
111 CDI	84	10/14 →	1.598	D	M	4	16	OM622.951		84034	
111 CDI / 111 BlueTEC	84	10/14 →	1.598	D	M	4	16	OM622.951		84034	

## MG

### Metro

1300	54	05/82 → 09/90	1.275	B	M	4	8		BC	81419	
Turbo	69	10/82 → 09/90	1.275	B	M	4	8		BC	81419	

### MG TF

115	85	03/02 → 12/09	1.588	B	M	4	16	16K4F		81615	
120	88	03/02 → 12/09	1.796	B	A	4	16	18K4F		81615	
135	100	03/02 → 12/09	1.796	B	M	4	16	18K4F		81615	
160	118	03/02 → 12/09	1.796	B	M	4	16	18K4K		81615	

### MG ZR

105	76	06/01 → 04/05	1.396	B	M	4	16	14K4F		81615	
120	86	06/01 → 04/05	1.796	B	M	4	16	18K4F		81615	
160	118	06/01 → 04/05	1.796	B	M	4	16	18K4K		81615	
2.0 TD	74	06/01 → 04/05	1.994	D	M	4	8	20T2N		81707	

### MG ZS

120	86	07/01 → 04/05	1.796	B	M	4	16	18K4F		81615	
180	130	07/01 → 04/05	2.497	B	M	6	24	25K4F		82029	
2.0 TD	74	01/04 → 04/05	1.994	D	M	4	8	20T2N		81707	
	83	01/04 → 04/05	1.994	D	M	4	8	20T2N		81707	



KW



cm<sup>3</sup>



NO. OF VALVES



MAGNETI MARELLI

## MG

### MGF

1.8 i VVC	118	10/01 → 03/02	1.796	B	M	4	16	18K4K		81615
1.6	82	02/00 → 03/02	1.588	B	M	4	16	16K4F		81615
1.8 i 16V	88	03/95 → 03/02	1.796	B	M	4	16	18K4F		81615
1.8 i VVC	107	03/95 → 03/02	1.796	B	M	4	16	18K4K		81615

## MINI

### Mini Clubvan

Cooper D	82	12/12 →	1.598	D	M	4	16	N47C16A		84026	<b>NEW</b>
	82	12/12 →	1.995	D	M	4	16	N47C20A		84026	<b>NEW</b>

### Mini Countryman (R60)

Cooper	85	06/10 →	1.598	B	M	4	16	N16B16A	→ 11-2012	82032	
	90	06/10 →	1.598	B	M	4	16	N16B16A	→ 11-2012	82032	
Cooper ALL4	90	11/14 →	1.598	B	M	4	16	N18B16A		82032	
Cooper D	82	06/10 →	1.598	D	M	4	16	N47C16A		84026	<b>NEW</b>
	82	02/11 →	1.995	D	M	4	16	N47C20A		84026	<b>NEW</b>
Cooper D ALL4	82	06/10 →	1.598	D	M	4	16	N47C16A		84026	<b>NEW</b>
	82	02/11 →	1.995	D	M	4	16	N47C20A		84026	<b>NEW</b>
Cooper S	135	06/10 →	1.598	B	M	4	16	N18B16A	→ 11-2012	82032	
	147	02/12 →	1.598	B	M	4	16	N18B16A	→ 11-2012	82032	
Cooper S ALL4	120	06/10 →	1.598	B	M	4	16	N18B16A	→ 11-2012	82032	
	135	06/10 →	1.598	B	M	4	16	N18B16A	→ 11-2012	82032	
Cooper S JCW	160	09/12 →	1.598	B	M	4	16	N18B16A	→ 11-2012	82032	
Cooper SD	105	02/11 →	1.995	D	M	4	16	N47C20A		84026	<b>NEW</b>
Cooper SD ALL4	100	02/11 →	1.995	D	M	4	16	N47C20A		84026	<b>NEW</b>
	105	02/11 →	1.995	D	M	4	16	N47C20A		84026	<b>NEW</b>
One	72	06/10 →	1.598	B	M	4	16	N16B16A	→ 11-2012	82032	
One D	66	06/10 →	1.598	D	M	4	16	N47C16A		84026	<b>NEW</b>

### Mini I (R50,R52, R53)

Cooper	85	06/01 → 09/06	1.598	B	M	4	16	W10B16A		81861	
Cooper S	120	03/02 → 09/06	1.598	B	M	4	16	W11B16A		84013	<b>NEW</b>
	125	07/04 → 09/06	1.598	B	M	4	16	W11B16A		81861	
John Cooper Works	155	07/04 → 11/07	1.598	B	M	4	16	W11B16A		84013	<b>NEW</b>
	160	03/06 → 09/06	1.598	B	M	4	16	W11B16A		82032	
One	55	04/03 → 09/06	1.398	B	M	4	16	W10B14A		81861	
	66	06/01 → 09/06	1.598	B	M	4	16	W10B16A		81861	
One D	55	06/03 → 09/06	1.364	D	M	4	8	1ND		81821	
	65	06/03 → 09/06	1.364	D	M	4	8	1ND-TV		81821	
S Works	147	11/03 → 06/05	1.598	B	M	4	16	W11B16A		84013	<b>NEW</b>
Works	155	11/03 → 09/06	1.598	B	M	4	16	W11B16A		84013	<b>NEW</b>

		KW		cm <sup>3</sup>				NO. OF VALVES		
--	--	----	--	-----------------	--	--	--	---------------	--	--

## MINI

### Mini II (R55, R56, R57, R58, R59)

Cooper	85	03/10 → 11/13	1.598	B	M	4	16	N12B16A, N16B16A	→ 11-2012	82032
	85	03/09 →	1.598	B	M	4	16	N16B16A	→ 11-2012	82032
	88	10/06 → 02/12	1.598	B	M	4	16	N12B16A	→ 11-2012	82032
	88	10/07 → 12/13	1.598	B	M	4	16	N12B16A, N16B16A	→ 11-2012	82032
	90	09/09 → 11/13	1.598	B	M	4	16	N16B16A	→ 11-2012	82032
Cooper D	80	10/07 → 02/10	1.560	D	M	4	16	9HZ (DV6TED4)		81869
	80	11/06 → 09/10	1.560	D	M	4	16	9HZ (DV6TED4), W16D16		81869
	82	06/10 → 11/13	1.598	D	M	4	16	N47C16A		84026 <b>NEW</b>
	82	02/11 → 11/13	1.995	D	M	4	16	N47C20A		84026 <b>NEW</b>
Cooper S	120	10/07 → 02/10	1.598	B	M	4	16	N14B16A	→ 11-2012	82032
	120	03/10 → 11/13	1.598	B	M	4	16	N18B16A	→ 11-2012	82032
	120	09/11 →	1.598	B	M	4	16	N18B16A		82032
	128	10/06 → 01/11	1.598	B	M	4	16	N14B16A	→ 11-2012	82032
	135	03/10 → 11/13	1.598	B	M	4	16	N18B16A	→ 11-2012	82032
	135	09/11 →	1.598	B	M	4	16	N18B16A		82032
	147	03/10 →	1.598	B	M	4	16	N18B16A	→ 11-2012	82032
	147	01/12 → 11/13	1.598	B	M	4	16	N18B16A		82032
Cooper SD	100	02/11 → 11/13	1.995	D	M	4	16	N47C20A		84026 <b>NEW</b>
	105	02/11 → 11/13	1.995	D	M	4	16	N47C20A		84026 <b>NEW</b>
	105	02/11 →	1.995	D	M	4	16	N47C20A		82032
John Cooper Works	141	10/08 → 02/10	1.598	B	M	4	16	N14B16A		82032
	141	11/06 → 12/11	1.598	B	M	4	16	N14B16C	→ 11-2012	82032
	155	03/08 → 08/12	1.598	B	M	4	16	N14B16C		82032
	155	03/08 → 11/13	1.598	B	M	4	16	N14B16C	→ 11-2012	82032
	155	02/12 →	1.598	B	M	4	16	N14B16C, N18B16C	→ 11-2012	82032
John Cooper Works GP	160	09/12 → 11/13	1.598	B	M	4	16	N18B16C	→ 11-2012	82032
One	55	03/09 → 03/10	1.397	B	M	4	16	N12B14A	→ 11-2012	82032
	70	11/06 → 03/10	1.397	B	M	4	16	N12B14A	→ 11-2012	82032
	55	03/10 → 11/13	1.598	B	M	4	16	N16B16A	→ 11-2012	82032
	72	03/10 → 11/13	1.598	B	M	4	16	N16B16A	→ 11-2012	82032
One D	66	06/09 → 07/10	1.560	D	M	4	16	9HZ (DV6TED4)		81869
	66	07/10 → 11/13	1.598	D	M	4	16	N47C16A		84026 <b>NEW</b>

### Mini III (F54, F55, F56, F57)

Cooper	100	07/14 →	1.499	B	M	3	12	B38A15A		84049 <b>NEW</b>
Cooper D	85	07/14 →	1.496	D	M	3	12	B37C15A		84050 <b>NEW</b>
Cooper S	141	07/14 →	1.998	B	M	4	16	B46A20A, B48A20A		84049 <b>NEW</b>
	141	11/15 →	1.998	B	M	4	16	B48A20A		84049 <b>NEW</b>
Cooper SD	125	07/14 →	1.995	D	M	4	16	B47C20A		84051 <b>NEW</b>
John Cooper Works	170	03/15 →	1.998	B	M	4	16	B48A20B		84049 <b>NEW</b>
One	75	11/14 →	1.198	B	M	3	12	B38A12A		84049 <b>NEW</b>
	75	11/15 →	1.499	B	M	3	12	B38A15A		84049 <b>NEW</b>
One D	70	11/14 →	1.496	D	M	3	12	B37C15A		84050 <b>NEW</b>
One First	55	06/14 →	1.198	B	M	3	12	B38A12A		84049 <b>NEW</b>

**KW**

**cm<sup>3</sup>**

**NO. OF  
VALVES**

**MAGNETI  
MARELLI**
**MINI**
**Mini Paceman (R61)**

Cooper D	82	09/12 →	1.598	D	M	4	16	N47C16A		84026	<b>NEW</b>
	82	09/12 →	1.995	D	M	4	16	N47C20A		84026	<b>NEW</b>
Cooper D ALL4	82	09/12 →	1.598	D	M	4	16	N47C16A		84026	<b>NEW</b>
	82	09/12 →	1.995	D	M	4	16	N47C20A		84026	<b>NEW</b>
Cooper SD	105	10/12 →	1.995	D	M	4	16	N47C20A		84026	<b>NEW</b>
Cooper SD ALL4	105	10/12 →	1.995	D	M	4	16	N47C20A		84026	<b>NEW</b>

**MITSUBISHI**
**ASX, Van**

1.6	85	05/10 →	1.590	B	M	4	16	4A92		82049	
	86	06/10 →	1.590	B	M	4	16	4A92		82049	
1.6 DI-D	84	07/15 →	1.560	D	M	4	8	9HD		81869	
1.6 DI-D 4WD	84	07/15 →	1.560	D	M	4	8	9HD		81869	
1.8 DI-D	85	06/10 →	1.798	D	M	4	16	4N13		84042	<b>NEW</b>
	110	06/10 →	1.798	D	M	4	16	4N13		84042	<b>NEW</b>
1.8 DI-D 4WD	85	06/10 →	1.798	D	M	4	16	4N13		84042	<b>NEW</b>
	110	06/10 →	1.798	D	M	4	16	4N13		84042	<b>NEW</b>
2.2 Di-D 4WD	110	04/13 →	2.268	D	M	4	16	4N14		84042	<b>NEW</b>

**Carisma**

1.9 DI-D	85	09/00 → 06/06	1.870	D	M	4	8	F9Q2		81814	
	85	09/00 → 06/06	1.870	D	M	4	8	F9Q2		84009	
	75	09/00 → 06/06	1.870	D	M	4	8	F9Q1		81814	
	75	09/00 → 06/06	1.870	D	M	4	8	F9Q1		84009	
1.9 TD	66	10/96 → 09/00	1.870	D	M	4	8	F8QT		81574	

**Colt III**

1.3	51	04/88 → 05/92	1.299	B	M	4	8	4G13 (8V)		81784	
1.3 12V	55	04/88 → 05/92	1.299	B	M	4	12	4G13 (12V)		81784	
1.3 GL	44	04/88 → 12/90	1.299	B	M	4	8	4G13 (8V)		81784	
1.5	66	07/90 → 05/92	1.468	B	M	4	12	4G15 (12V)		81784	
1.5 GLXi	62	04/88 → 05/92	1.468	B	M	4	8	4G15		81784	
1.8 GTi 16V	100	06/90 → 05/92	1.836	B	M	4	16	4G67		81786	

**Colt IV**

1.3 GLi 12V	55	04/92 → 04/96	1.299	B	M	4	12	4G13 (12V)		81784	
1.6 4WD	84	08/93 → 08/95	1.597	B	M	4	16	4G92 (SOHC16V)		81731	
1.6 GLXi 16V	83	04/92 → 04/96	1.597	B	M	4	16	4G92 (SOHC16V)		81731	
1.8 GTi 16V	103	04/92 → 04/96	1.834	B	M	4	16	4G93 (DOHC16V), 4G93 (SOHC16V)		81731	

**Colt V**

1.5 16V	69	10/99 → 09/03	1.468	B	M	4	16	4G15 (16V)		81784	
---------	----	---------------	-------	---	---	---	----	------------	--	-------	--

**Colt VI**

1.1	55	10/04 → 06/12	1.124	B	M	3	12	3A91		82049	
1.1 Bifuel	55	10/04 → 06/12	1.124	BF	M	3	12	3A91		82049	
1.3	70	06/04 → 06/12	1.332	B	M	4	16	4A90		82049	
1.3 Bifuel	70	06/04 → 06/12	1.332	BF	M	4	16	4A90		82049	

		KW		cm <sup>3</sup>				NO. OF VALVES		
--	--	----	--	-----------------	--	--	--	---------------	--	--

## MITSUBISHI

### Colt VI

1.5	80	06/04 → 06/12	1.499	B	M	4	16	4A91		82049
1.5 DI-D	50	08/04 → 06/12	1.493	D	M	3	12	OM639.939		82017
	70	08/04 → 06/12	1.493	D	M	3	12	OM639.939		82017

### Colt VII, CZC, Plus

1.5	80	05/06 → 07/09	1.499	B	M	4	16	4A91		82049
-----	----	---------------	-------	---	---	---	----	------	--	-------

### Eclipse I, Cabrio

2.0 i 16V	110	04/91 → 11/95	1.997	B	M	4	16	4G63 (DOHC16V)		81786
2.0 i 16V 4WD	110	04/91 → 11/95	1.997	B	M	4	16	4G63 (DOHC16V)		81786

### Eclipse II, Cabrio

2.0 Turbo	147	04/94 → 04/99	1.997	B	M	4	16	4G63T (DOHC16V)		81733
2.0 Turbo 4WD	157	12/95 → 04/99	1.997	B	M	4	16	4G63T (DOHC16V)		81733
	147	04/94 → 04/99	1.997	B	M	4	16	4G63T (DOHC16V)		81733
2000 GS 16V	107	12/95 → 04/99	1.997	B	M	4	16	4G63 (DOHC16V)		81733
	157	12/95 → 04/99	1.997	B	M	4	16	4G63T (DOHC16V)		81733

### Galant IV, Station Wagon

2.0 GTI 16V	106	11/88 → 10/92	1.997	B	M	4	16	4G63 (DOHC16V)		81786
	107	11/88 → 10/92	1.997	B	M	4	16	4G63 (DOHC16V)		81786
2.0 GTi 16V 4WD	106	06/88 → 10/92	1.997	B	M	4	16	4G63 (DOHC16V)		81786
	110	09/91 → 10/92	1.997	B	M	4	16	4G63 (DOHC16V)		81786
2.0 GTI 16V 4x4	106	07/89 → 12/92	1.997	B	M	4	16	4G63 (DOHC16V)		81786

### Galant V, Station Wagon

1.8	85	02/94 → 08/96	1.834	B	M	4	16	4G93 (SOHC16V)		81731
1.8 GLSI	93	11/92 → 08/96	1.834	B	M	4	16	4G93 (SOHC16V)	01-1993 →	81731
	93	11/92 → 08/96	1.834	B	M	4	16	4G93 (SOHC16V)		81731

### Grandis II

2.0 DI-D	100	09/05 →	1.968	D	M	4	16	BSY		81816
	100	09/05 →	1.968	D	M	4	16	BSY		84011
	103	02/07 →	1.968	D	M	4	16	BWC		81816
	103	02/07 →	1.968	D	M	4	16	BWC		84011

### L 200 II

2.5 D	51	11/86 → 10/96	2.476	D	M	4	8	4D56 (8V)	→ 06-1996	81787
2.5 D 4WD	51	12/87 → 05/93	2.476	D	M	4	8	4D56 (8V)		81787

### L 200 III

2.5 D	55	06/96 → 12/07	2.477	D	M	4	8	4D56 (8V)		81787
-------	----	---------------	-------	---	---	---	---	-----------	--	-------

### L 300

2.5 D	51	11/86 → 02/06	2.477	D	M	4	8	4D56 (8V)		81787
2.5 TD	64	02/87 → 08/97	2.477	D	M	4	8	4D56T		81787
	64	02/87 → 05/03	2.477	D	M	4	8	4D56T		81787

### L 400

2.5 TD	73	05/95 → 05/00	2.477	D	M	4	8	4D56TD		81787
2.5 TD 4WD	73	05/95 → 05/00	2.477	D	M	4	8	4D56TD		81787
2500 TD	64	05/95 → 06/05	2.477	D	M	4	8	4D56T		81787
	64	09/96 → 06/05	2.477	D	M	4	8	4D56T		81787
2500 TD 4WD	64	09/96 → 06/05	2.477	D	M	4	8	4D56T		81787

**KW**

**cm<sup>3</sup>**

**NO. OF VALVES**

**MITSUBISHI**
**Lancer III, Station Wagon**

1.3 GL	50	05/88 → 06/90	1.298	B	M	4	8	G13B		81784
	55	07/90 → 08/92	1.298	B	M	4	12	4G13 (12V)		81784
1.5	61	09/88 → 12/90	1.468	B	M	4	8	4G15		81784
1.5 12V	66	09/90 → 12/91	1.468	B	M	4	12	4G15 (12V)		81784
1.5 GLS	63	08/89 → 08/92	1.468	B	M	4	12	4G15 (12V)		81784
1.8 4WD	69	08/90 → 06/92	1.755	B	M	4	8	4G37	01-1992 →	81731

**Lancer IV, Station Wagon**

1.2 GL	44	05/88 → 08/92	1.198	B	M	4	8	4G16		81784
1.3	44	04/88 → 05/92	1.299	B	M	4	8	4G13 (8V)		81784
	51	08/88 → 05/92	1.299	B	M	4	8	4G13 (8V), G13B		81784
1.3 12V	55	06/92 → 05/94	1.299	B	M	4	12	4G13 (12V)		81784
1.3 GL	50	05/88 → 06/90	1.298	B	M	4	8	G13B		81784
1.5	62	06/88 → 05/92	1.468	B	M	4	8	4G15		81784
	62	04/88 → 05/92	1.468	B	M	4	12	4G15 (12V)		81784
1.5 12V	66	05/89 → 05/92	1.468	B	M	4	12	4G15 (12V)		81784
1.5 GLS	63	08/89 → 08/92	1.468	B	M	4	12	4G15 (12V)		81784
1.6 16V	83	06/92 → 05/94	1.597	B	M	4	16	4G92 (SOHC16V)		81731
1.6 4WD	84	06/92 → 11/93	1.597	B	M	4	16	4G92 (SOHC16V)		81731
1.8 GTi 16V	103	06/92 → 12/93	1.834	B	M	4	16	4G93 (DOHC16V), 4G93 (SOHC16V)		81731
	100	11/89 → 05/92	1.836	B	M	4	16	4G67		81786

**Lancer V, Station Wagon, Hatchback, Coupé**

1.3	55	06/92 → 02/95	1.298	B	M	4	12	4G13 (12V)		81784
	55	06/92 → 12/96	1.299	B	M	4	12	4G13 (12V)		81784
1.6	66	02/94 → 12/96	1.597	B	M	4	16	4G92 (SOHC16V)		81731
1.6 16V	83	06/92 → 12/96	1.597	B	M	4	16	4G92 (SOHC16V)		81731
	83	12/92 → 10/03	1.597	B	M	4	16	4G92 (SOHC16V)	→ 02-1996	81731
1.6 16V 4WD	83	06/92 → 12/96	1.597	B	M	4	16	4G92 (SOHC16V)		81731
	83	12/92 → 10/03	1.597	B	M	4	16	4G92 (SOHC16V)	→ 02-1996	81731
1.8 16V	103	06/92 → 12/93	1.834	B	M	4	16	4G93 (DOHC16V)		81731

**Lancer VI, Station Wagon, Hatchback, Coupé, Cabrio**

1.5 16V	69	10/99 → 08/03	1.468	B	M	4	16	4G15 (16V)		81784
---------	----	---------------	-------	---	---	---	----	------------	--	-------

**Lancer VIII, Station Wagon, Sportback**

1.5	80	06/08 →	1.499	B	M	4	16	4A91		82049
2.0 DI-D	103	06/08 →	1.968	D	M	4	16	BKD, BWC		81816
	103	06/08 →	1.968	D	M	4	16	BKD, BWC		84011 <b>NEW</b>

**Outlander II, Van**

2.0 DI-D	103	02/07 → 11/12	1.968	D	M	4	16	BSY		81816
	103	02/07 → 11/12	1.968	D	M	4	16	BSY		84011 <b>NEW</b>
	130	11/06 → 11/12	2.268	D	M	4	16	4N14		84042 <b>NEW</b>
2.2 DI-D 4WD	115	08/07 → 11/12	2.179	D	M	4	16	4HK, 4HN		82068
	103	09/10 → 11/12	2.268	D	M	4	16	4N14		84042 <b>NEW</b>
	130	11/06 → 11/12	2.268	D	M	4	16	4N14		84042 <b>NEW</b>

		KW		cm <sup>3</sup>				NO. OF VALVES		
--	--	----	--	-----------------	--	--	--	---------------	--	--

## MITSUBISHI

### Outlander III, Van

2.2 Di-D	110	08/12 →	2.268	D	M	4	16	4N14		84042	
2.2 Di-D 4WD	110	08/12 →	2.268	D	M	4	16	4N14		84042	

### Pajero I

2.5 TD	64	01/90 → 12/91	2.477	D	M	4	8	4D56T		81787
	70	11/89 → 11/90	2.477	D	M	4	8	4D56T		81787

### Santamo

2.0 16V	102	05/99 → 12/04	1.997	B	M	4	16	4G63 (DOHC16V)		81786
2.0 16V 4WD	102	05/99 → 12/04	1.997	B	M	4	16	4G63 (DOHC16V)		81786

### Space Runner I

1.8	85	06/96 → 08/99	1.834	B	M	4	16	4G93 (SOHC16V)		81731
	90	10/91 → 08/99	1.834	B	M	4	16	4G93 (SOHC16V)		81731
1.8 4WD	85	06/96 → 08/99	1.834	B	M	4	16	4G93 (SOHC16V)		81731
	90	10/91 → 08/99	1.834	B	M	4	16	4G93 (SOHC16V)		81731

### Space Star

1.3 16V	60	09/00 → 12/04	1.299	B	M	4	16	4G13 (16V)		81784
	61	12/98 → 12/04	1.299	B	M	4	16	4G13 (16V)		81784
	63	06/98 → 12/04	1.299	B	M	4	16	4G13 (16V)		81784
1.9 Di-D	85	10/02 → 12/04	1.870	D	M	4	8	F9Q2		81814
	85	10/02 → 12/04	1.870	D	M	4	8	F9Q2		84009
	75	02/01 → 12/04	1.870	D	M	4	8	F9Q1		81814
	75	02/01 → 12/04	1.870	D	M	4	8	F9Q1		84009

### Space Wagon II

1.8	90	10/91 → 10/98	1.834	B	M	4	16	4G93 (SOHC16V)		81731
1.8 4WD	90	10/91 → 10/98	1.834	B	M	4	16	4G93 (SOHC16V)		81731

## NISSAN

### 100 NX

1.6	66	03/90 → 10/94	1.597	B	M	4	16	GA16DS		81744
1.6 SR	75	09/93 → 10/94	1.597	B	M	4	16	GA16DE		81744
2.0	110	10/90 → 10/94	1.998	B	M	4	16	SR20DE		81736
2.0 GTI	105	03/91 → 10/94	1.998	B	M	4	16	SR20DE		81736

### 200 SX III

2.0 i 16V	118	10/93 → 12/99	1.998	B	M	4	16	SR20DE		81736
-----------	-----	---------------	-------	---	---	---	----	--------	--	-------

### Almera I, Hatchback

1.4	64	09/95 → 07/00	1.392	B	M	4	16	GA14DE		81744
1.4 GX,LX	55	09/95 → 07/00	1.392	B	M	4	16	GA14DE		81744
1.4 S,GX,LX	55	09/95 → 03/00	1.392	B	M	4	16	GA14DE		81744
1.6	73	09/95 → 07/00	1.597	B	M	4	16	GA16DE		81744
1.6 SLX	66	09/95 → 07/00	1.597	B	M	4	16	GA16DE		81744
1.6 SR,SLX	66	09/95 → 03/00	1.597	B	M	4	16	GA16DE		81744
2.0 D	55	11/95 → 03/00	1.974	D	M	4	8	CD20		81745
	55	11/95 → 07/00	1.974	D	M	4	8	CD20		81736
2.0 GTi	105	07/96 → 03/00	1.998	B	M	4	16	SR20DE		81736

**KW**

**cm<sup>3</sup>**

**NO. OF VALVES**

**MAGNETI MARELLI**
**NISSAN**
**Almera II, Hatchback**

1.5	72	10/02 →	1.497	B	M	4	16	QG15DE		82028
	66	07/00 →	1.498	B	M	4	16	QG15DE		82028
	77	03/01 →	1.498	B	M	4	16	GA15DE, QG15DE		82028
1.5 dCi	60	01/03 →	1.461	D	M	4	8	K9K722		81810
1.5 XL	77	03/01 →	1.498	B	M	4	16	QG15DE		82028
1.8	84	07/00 →	1.769	B	M	4	16	QG18DE		82028
	85	10/02 →	1.769	B	M	4	16	QG18DE		82028
2.2 dCi	82	09/03 →	2.184	D	M	4	16	YD22DDT		82023
	100	09/03 →	2.184	D	M	4	16	YD22DDTi		82023
2.2 Di	81	07/00 →	2.184	D	M	4	16	YD22DDT		82023

**Almera Tino**

1.8	84	08/00 →	1.769	B	M	4	16	QG18DE		82028
	85	12/02 →	1.769	B	M	4	16	QG18DE		82028
2.0	100	08/00 →	1.998	B	A	4	16	SR20DE		81736
2.2 dCi	82	09/03 →	2.184	D	M	4	16	YD22DDT		82023
	100	09/03 →	2.184	D	M	4	16	YD22DDTi		82023
2.2 Di	84	08/00 →	2.184	D	M	4	16	YD22DDTi		82023

**Cube III**

1.5 dCi	78	03/10 →	1.461	D	M	4	8	K9K, K9K270		82098
	81	03/10 →	1.461	D	M	4	8	K9K, K9K270		82098
1.6 16V	81	03/10 →	1.598	B	M	4	16	HR16DE		84003

**Interstar**

dCi 80	60	07/02 →	1.870	D	M	4	8	F9Q772		81814
	60	07/02 →	1.870	D	M	4	8	F9Q772		84009
dCi 90	66	07/02 →	2.188	D	M	4	16	G9T722		81855

**Juke**

1.2 DIG-T	85	05/14 →	1.197	B	M	4	16	HR12DDT		84003
1.5 dCi	81	06/10 →	1.461	D	M	4	8	K9K636, K9K896		82098
1.6	69	01/13 →	1.598	B	M	4	16	HR16DE		84003
	86	06/10 →	1.598	B	M	4	16	HR16DE		84003

**Kubistar**

1.2	44	08/03 → 10/09	1.149	B	M	4	8	D7F764		81762
1.2 16V	55	04/06 → 10/09	1.149	B	M	4	16	D4F712		81820
1.5 dCi	42	08/03 → 10/09	1.461	D	M	4	8	K9K710, K9K714		81810
	45	08/05 → 10/09	1.461	D	M	4	8	K9K710, K9K714		81810
	48	08/03 → 10/09	1.461	D	M	4	8	K9K704		81810
	60	08/03 → 10/09	1.461	D	M	4	8	K9K722		81810
1.5 dCi 70	50	04/06 → 10/09	1.461	D	M	4	8	K9K700, K9K716		84007
1.5 dCi 85	62	04/06 → 10/09	1.461	D	M	4	8	K9K276		84007
1.6 16V	70	08/03 → 10/09	1.598	B	M	4	16	K4M752		84039
	70	08/03 → 10/09	1.598	B	M	4	16	K4M752		81806

**NEW**



--	--	--	--	--	--	--	--	--	--

## NISSAN

### Micra I (K10)

1.0	43	12/82 → 05/91	988	B	M	4	8		01-1989 →, M →: 945.693	81743
1.2	40	07/86 → 07/92	1.235	B	M	4	8	MA12S	01-1989 →, M →: 945.693	81743
	44	07/86 → 07/92	1.235	B	M	4	8	MA12S	01-1989 →, M →: 945.693	81743

### Micra II (K11)

1.0 i 16V	40	08/92 → 09/00	998	B	M	4	16	CG10DE		81742
	44	09/00 → 02/03	998	B	M	4	16	CG10DE		81742
1.3 i 16V	55	08/92 → 09/00	1.275	B	M	4	16	CG13DE		81742
1.4 i 16V	60	09/00 → 02/03	1.348	B	M	4	16	CGA3DE		81742
1.5 D	42	02/98 → 02/03	1.527	D	M	4	8	TD15		81513

### Micra III (K12), C+C

1.0 16V	48	01/03 → 06/10	998	B	M	4	16	CG10DE		82014
1.2 16V	48	01/03 → 06/10	1.240	B	M	4	16	CG12DE, CR12DE		82014
	59	01/03 → 06/10	1.240	B	M	4	16	CG12DE, CR12DE		82014
1.4 16V	65	08/05 →	1.386	B	M	4	16	CR14DE		82014
1.5 dCi	48	01/03 → 06/10	1.461	D	M	4	8	K9K704		81810
	50	06/05 → 06/10	1.461	D	M	4	8	K9K708		84007
	60	09/03 → 06/10	1.461	D	M	4	8	K9K722		81810
	63	06/05 → 06/10	1.461	D	M	4	8	K9K276		84007
1.6 160 SR	81	08/05 →	1.598	B	M	4	16	HR16DE		84003
160 SR	81	05/05 → 06/10	1.598	B	M	4	16	HR16DE		82014

### Micra IV (K13)

1.2	56	05/10 →	1.198	B	M	3	12	HR12DE		84003
	59	05/10 →	1.198	B	M	3	12	HR12DE		84003
1.2 DIG	72	04/11 →	1.198	B	M	3	12	HR12DDR		84003

### Note I

1.4	65	03/06 →	1.386	B	M	4	16	CR14DE		82014
1.5 dCi	50	03/06 →	1.461	D	M	4	8	K9K700		84007
	63	03/06 →	1.461	D	M	4	8	K9K276		84007
	66	09/10 →	1.461	D	M	4	8	K9K276		84007
	76	07/08 →	1.461	D	M	4	16	K9K292		84007
1.6	81	03/06 →	1.598	B	M	4	16	HR16DE		84003

### Note II

1.2	59	06/13 →	1.198	B	M	3	12	HR12DE		84003
1.2 DIG	72	06/13 →	1.198	B	M	3	12	HR12DDR		84003
1.2 LPG	56	03/15 →	1.198		M	3	12	HR12DE		84003
1.5 dCi	66	06/13 →	1.461	D	M	4	8	K9K892		82098

### NV 200 Evalia, Box

1.5 dci	63	07/10 →	1.461	D	M	4	8	K9K400, K9K608, K9K628		84007
	66	04/11 →	1.461	D	M	4	8	K9K892		84007
	81	04/11 →	1.461	D	M	4	8	K9K636, K9K646		84007

**KW**

**cm<sup>3</sup>**

**NO. OF VALVES**

**NISSAN**
**Pixo**

1.0	50	06/09 →	996	B	M	3	12	K10B		84017	<b>NEW</b>
-----	----	---------	-----	---	---	---	----	------	--	-------	------------

**Primastar**

2.0	88	02/03 →	1.998	B	M	4	16	F4R720		81814
	88	02/03 →	1.998	B	M	4	16	F4R720		84009
	88	03/01 →	1.998	B	M	4	16	F4R720, F4R722		81814
	88	03/01 →	1.998	B	M	4	16	F4R720, F4R722		84009
dCi 100	74	03/01 →	1.870	D	M	4	8	F9Q760		81814
	74	03/01 →	1.870	D	M	4	8	F9Q760		84009
dCi 120	84	09/06 →	1.995	D	M	4	16	M9R780		82069
dCi 140	99	07/03 →	2.463	D	M	4	16	G9U730		81855
dCi 80	60	03/01 →	1.870	D	M	4	8	F9Q762		81814
	60	03/01 →	1.870	D	M	4	8	F9Q762		84009
dCi 90	66	09/06 →	1.995	D	M	4	16	M9R782		82069

**Primera I, Hatchback, Station Wagon**

1.6	66	06/90 → 01/96	1.597	B	M	4	16	GA16DS		81744
	71	06/90 → 01/96	1.597	B	M	4	16	GA16DS		81744
	75	06/93 → 01/96	1.597	B	M	4	16	GA16DE		81744
1.6 i	66	07/90 → 03/98	1.597	B	M	4	16	GA16DS		81744
	75	02/91 → 03/98	1.597	B	M	4	16	GA16DE		81744
2.0	105	06/90 → 04/93	1.998	B	M	4	16	SR20DE		81736
	110	06/90 → 01/96	1.998	B	M	4	16	SR20DE		81736
2.0 16V	85	06/90 → 01/96	1.998	B	M	4	16	SR20DI		81736
2.0 16V 4x4	85	04/91 → 06/96	1.998	B	M	4	16	SR20DI		81736
2.0 D	55	01/91 → 01/96	1.974	D	M	4	8	CD20		81745
2.0 GT	110	06/90 → 01/96	1.998	B	M	4	16	SR20DE		81736
2.0 GT 4x4	105	03/91 → 04/93	1.998	B	M	4	16	SR20DE		81736
2.0 i	85	07/90 → 03/98	1.998	B	M	4	16	SR20DI		81736
	92	01/95 → 06/96	1.998	B	M	4	16	SR20DE		81736

**Primera II, Hatchback, Station Wagon**

1.6 16V	66	09/96 → 12/01	1.597	B	M	4	16	GA16DE		81744
	73	09/96 → 10/00	1.597	B	M	4	16	GA16DE		81744
	78	06/96 → 12/01	1.597	B	M	4	16	QG16DE		81744
	80	04/98 → 12/01	1.597	B	M	4	16	QG16DE		81744
1.8 16V	84	08/99 → 12/01	1.769	B	M	4	16	QG18DE		82028
2.0 16V	85	09/96 → 12/01	1.998	B	M	4	16	SR20De		81736
	96	09/96 → 12/01	1.998	B	M	4	16	SR20DE		81736
	103	08/99 → 12/01	1.998	B	M	4	16	SR20DE		81736
	110	09/96 → 12/01	1.998	B	M	4	16	SR20DE		81736
2.0 TD	66	09/96 → 12/01	1.974	D	M	4	8	CD20T		81745

**Primera III, Hatchback, Station Wagon**

1.6	78	03/02 →	1.597	B	M	4	16	QG16DE		82028
1.6 Visia	80	01/02 →	1.597	B	M	4	16	QG16DE		82028
1.8	85	03/02 →	1.769	B	M	4	16	QG18DE		82028

**KW**

**cm<sup>3</sup>**

**NO. OF VALVES**

**MAGNETI MARELLI**
**NISSAN**
**Primera III, Hatchback, Station Wagon**

1.9 dCi	88	04/03 →	1.870	D	M	4	8	F9Q		81868
	88	04/03 →	1.870	D	M	4	8	F9Q		84006
2.0	103	03/02 →	1.998	B	M	4	16	QR20DE		84061 <b>NEW</b>
2.2 dCi	102	04/03 →	2.184	D	M	4	16	YD22DDT		82023
2.2 Di	93	03/02 →	2.184	D	M	4	16	YD22DDT		82023

**Pulsar**

1.2 DIG-T	85	10/14 →	1.197	B	M	4	16	HR12DDT		84003
1.5 dCi	81	10/14 →	1.461	D	M	4	8	K9K		82098

**Qashqai I**

1.5 dCi	76	07/08 →	1.461	D	M	4	8	K9K410		84007
	78	02/07 →	1.461	D	M	4	8	K9K732, K9K764		84007
	81	11/10 →	1.461	D	M	4	8	K9K430		84007
1.6	84	02/07 →	1.598	B	M	4	16	HR16DE		84003
	86	11/10 →	1.598	B	M	4	16	HR16DE		84003
1.6 dCi	96	10/11 →	1.598	D	M	4	16	R9M		84034 <b>NEW</b>
1.6 dCi Trazione integrale	96	10/11 →	1.598	D	M	4	16	R9M		84034 <b>NEW</b>
2.0 dCi	110	02/07 →	1.995	D	M	4	16	M1D, M9R		82069
2.0 dCi Trazione integrale	110	02/07 →	1.995	D	M	4	16	M1D, M9R		82069

**Qashqai II**

1.2 DIG-T	85	11/13 →	1.197	B	M	4	16	HR12DDT		84003
1.5 dCi	81	11/13 →	1.461	D	M	4	8	K9K636		82098
1.6 dCi	96	11/13 →	1.598	D	M	4	16	R9M		84034 <b>NEW</b>
1.6 dCi 4x4	96	11/13 →	1.598	D	M	4	16	R9M		84034 <b>NEW</b>

**Sentra VII**

1.6	86	08/14 →	1.598	B	M	4	16	HR16DE		84003
-----	----	---------	-------	---	---	---	----	--------	--	-------

**Serena I**

1.6	75	10/94 → 08/00	1.597	B	M	4	16	GA16DE		81744
1.6 16V	71	02/93 → 09/01	1.597	B	M	4	16	GA16DE		81744
2.0 16V	93	11/92 → 09/01	1.998	B	M	4	16	SR20DE		81736
2.0 D	49	11/92 → 09/01	1.952	D	M	4	8	LD20		82054
2.3 D	55	01/95 → 09/01	2.283	D	M	4	8	LD23		82053

**Sunny III**

1.4	60	10/90 → 06/95	1.392	B	M	4	16	GA14DS		81744
1.4 i	55	10/90 → 05/95	1.392	B	M	4	16	GA14DE, GA14DS		81744
1.4 i 16V	64	10/90 → 06/95	1.392	B	M	4	16	GA14DE		81744
1.6 16V 4x4	66	11/90 → 05/95	1.597	B	M	4	16	GA16DS		81744
1.6 i	66	10/90 → 05/95	1.597	B	M	4	16	GA16DE, GA16DEL, GA16DS		81744
	66	06/91 → 03/00	1.597	B	M	4	16	GA16DE, GA16DS		81744
1.6 i 16V	66	10/92 → 03/00	1.597	B	M	4	16	GA16DE		81744
1.6 i 16V	75	10/92 → 05/95	1.597	B	M	4	16	GA16DE		81744
1.6 i 16V 4WD	66	10/90 → 05/95	1.597	B	M	4	16	GA16DS		81744

**KW**

**cm<sup>3</sup>**

**NO. OF VALVES**

**MAGNETI MARELLI**
**NISSAN**
**Sunny III**

1.6 i 16V 4x4	75	10/92 → 05/95	1.597	B	M	4	16	GA16DE		81744
1.6 L	75	11/92 → 04/96	1.597	B	M	4	16	GA16DE		81744
1.6 SR 4x4	66	01/92 → 06/95	1.598	B	M	4	16	GA16DEL		81744
2.0 D	55	10/90 → 05/95	1.974	D	M	4	8	CD20		81745
2.0 GTI 16V	105	10/90 → 05/95	1.998	B	M	4	16	SR20DE		81736
2.0 GTI-R 4x4	162	10/90 → 05/95	1.998	B	M	4	16	SR20DET		81736
2.0 i 16V	105	10/90 → 05/95	1.998	B	M	4	16	SR20DE		81736

**Tiida II**

1.5 dCi	78	09/07 →	1.461	D	M	4	8	K9K		84007
	78	09/07 →	1.461	D	M	4	8	K9K728		84007
1.6	81	09/07 →	1.598	B	M	4	16	HR16DE		84003

**Vanette II**

2.0 D	49	07/91 → 01/95	1.952	D	M	4	8	LD20II		82054
	47	10/86 → 12/95	1.952	D	M	4	8	LD20		82054
	49	10/86 → 12/95	1.952	D	M	4	8	LD20		82054

**Vanette III Cargo**

1.6 i	71	01/95 →	1.597	B	M	4	16	GA16DE		81744
	72	01/96 →	1.597	B	M	4	16	GA16DE		81744
2.0 D	49	01/96 →	1.952	D	M	4	8	LD20		82054
2.3 D	55	01/96 →	2.283	D	M	4	8	LD23		82053

**X-Trail I**

2.0	103	07/01 → 01/13	1.998	B	M	4	16	QR20DE		84061	<b>NEW</b>
	110	09/01 → 01/13	1.998	B	M	4	16	QR20DE		84061	<b>NEW</b>
2.0 4x4	103	07/01 → 01/13	1.998	B	M	4	16	QR20DE		84061	<b>NEW</b>
	110	09/01 → 01/13	1.998	B	M	4	16	QR20DE		84061	<b>NEW</b>
	206	06/01 → 01/13	1.998	B	M	4	16	SR20VET		84061	<b>NEW</b>
2.2 dCi	84	10/04 → 01/13	2.184	D	M	4	16	YD22DDTi		82023	
	100	12/03 → 01/13	2.184	D	M	4	16	YD22DDTi		82023	
2.2 dCi 4x4	100	12/03 → 01/13	2.184	D	M	4	16	YD22DDTi		82023	
2.2 DCi FWD	84	06/01 → 09/03	2.184	D	M	4	16	YD22DDTi		82023	
2.2 Di 4x4	84	07/01 → 10/05	2.184	D	M	4	16	YD22ETI		82023	
2.5 4x4	121	09/02 → 01/13	2.488	B	M	4	16	QR25DE		84061	<b>NEW</b>
	132	11/02 → 01/13	2.488	B	M	4	16	QR25DE		84061	<b>NEW</b>

**X-Trail II**

2.0 dCi	110	06/07 → 11/13	1.995	D	M	4	16	M9R		82069	
	127	06/07 → 11/13	1.995	D	M	4	16	M9R760		82069	
2.0 dCi FWD	110	06/07 → 11/13	1.995	D	M	4	16	M9R		82069	
2.5 4x4	124	06/07 → 11/13	2.488	B	M	4	16	QR25DE		84061	<b>NEW</b>

**X-Trail III**

1.6 dCi	96	12/13 →	1.598	D	M	4	16	R9M		84034	<b>NEW</b>
1.6 dCi 4x4	96	12/13 →	1.598	D	M	4	16	R9M		84034	<b>NEW</b>

		KW		cm <sup>3</sup>				NO. OF VALVES			
--	--	----	--	-----------------	--	--	--	---------------	--	--	--

## OPEL

### Adam

1.2	51	10/12 →	1.229	B	M	4	16	A12XEL, B12XEL		84027	
1.4	64	10/12 →	1.398	B	M	4	16	A14XEL, B14XEL		84027	
	74	10/12 →	1.398	B	M	4	16	A14XER, B14XER		84027	
1.4 LPG	64	07/13 →	1.398		M	4	16	A14XEL, B14XEL		84027	
1.4 S	110	11/14 →	1.364	B	M	4	16	B14NEH		84027	

### Agila A

1.0	44	08/03 → 12/07	998	B	M	3	12	Z10XEP		82011	
1.0 12V	43	09/00 → 12/07	973	B	M	3	12	Z10XE		81749	
1.2 16V	55	09/00 → 12/07	1.199	B	M	4	16	Z12XE		81749	
1.2 16V Twinport	59	07/04 → 12/07	1.229	B	M	4	16	Z12XEP		82011	
1.3 CDTI	51	08/03 → 12/07	1.248	D	M	4	16	Z13DT		81862	

### Agila B

1.0	48	04/08 →	996	B	M	3	12	K10B		84017	
	50	07/11 →	996	B	M	3	12	K10B		84017	
1.0 LPG	48	01/10 →	996		M	3	12	K10B		84017	
1.2	63	04/08 →	1.242	B	M	4	16	K12B		84017	
	69	11/10 →	1.242	B	M	4	16	K12B		84017	
1.2 LPG	63	04/08 →	1.242		M	4	16	K12B		84017	
1.3 CDTI	55	04/08 →	1.248	D	M	4	16	D13A, Z13DTJ		81862	

### Antara

2.0 CDTI	93	03/07 →	1.991	D	M	4	16	Z20DM, Z20S		84014	
	110	05/06 →	1.991	D	M	4	16	Z20DMH, Z20S		84014	
2.0 CDTI 4x4	110	05/06 →	1.991	D	M	4	16	Z20DMH, Z20S		84014	
2.4	123	12/10 →	2.384	B	M	4	16	A24XE		81812	
	103	09/08 →	2.405	B	M	4	16	Z24XE		81550	
	104	05/06 →	2.405	B	M	4	16	Z24XED		81550	
2.4 4x4	123	12/10 →	2.384	B	M	4	16	A24XE		81812	
	103	01/07 →	2.405	B	M	4	16	Z24XE		81550	
2.4 LPG	103	10/08 →	2.405		M	4	16	Z24XE		81550	
2.4 LPG 4x4	103	10/08 →	2.405		M	4	16	Z24XE		81550	
3.2 V6	167	03/07 →	3.195	B	M	6	24	10HM, Z32SEE		84057	

### Arena

1.9 D	44	01/97 → 12/01	1.870	D	M	4	8	19DJ, 19DL		81574	
	44	03/98 → 08/01	1.870	D	M	4	8	F8Q600, F8Q606		81574	

### Astra F Classic

1.4 i	44	01/98 → 08/02	1.389	B	M	4	8	X14NZ		81549	
1.6 i	55	01/98 → 08/02	1.598	B	M	4	8	X16SZR		81549	
1.6 i 16V	74	01/98 → 08/02	1.598	B	M	4	16	X16XEL		82005	

### Astra F, Station Wagon, Cabrio, Van

1.4	55	09/91 → 09/93	1.389	B	M	4	8	14NV		81549	
	60	09/92 → 09/98	1.389	B	M	4	8	14SE		81549	
1.4 i	44	03/92 → 01/98	1.389	B	M	4	8	C14NZ		81549	
	44	09/91 → 09/98	1.389	B	M	4	8	C14NZ, X14NZ		81549	
1.4 i 16V	66	02/96 → 09/98	1.389	B	M	4	16	X14XE		82005	

**KW**

**cm<sup>3</sup>**

**NO. OF  
VALVES**

**MAGNETI  
MARELLI**
**OPEL**
**Astra F, Station Wagon, Cabrio, Van**

1.4 Si	60	03/92 → 09/98	1.389	B	M	4	8	C14SE		81549
1.6	55	09/95 → 09/98	1.598	B	M	4	8	16LZ2, 16NZR		81551
1.6 i	52	05/93 → 07/96	1.598	B	M	4	8	X16SZ		81549
	55	10/91 → 04/93	1.598	B	M	4	8	C16NZ		81549
	55	03/92 → 09/98	1.598	B	M	4	8	C16NZ, X16SZR		81549
	55	01/96 → 03/01	1.598	B	M	4	8	X16SZR		81549
1.6 i 16V	74	08/94 → 09/98	1.598	B	M	4	16	X16XEL		82005
1.6 Si	74	05/92 → 12/94	1.598	B	M	4	8	C16SE		81549
1.7 D	42	03/92 → 09/92	1.700	D	M	4	8	17D		81605
	44	07/92 → 09/98	1.700	D	M	4	8	17DR	→ 12-1992, → M: 14.363.651	81605
	44	07/92 → 09/98	1.700	D	M	4	8	17DR	01-1993 →, M →: 14.363.652	81550
1.7 TD	60	03/95 → 02/98	1.686	D	M	4	8	X17DT (TC4EE1)		81687
	50	11/94 → 09/98	1.700	D	M	4	8	X17DTL		81550
1.7 TDS	60	03/92 → 09/98	1.686	D	M	4	8	17DT (TC4EE1), X17DT (TC4EE1)	→ 12-1992, → M: 855.805	81687
	60	03/92 → 09/98	1.686	D	M	4	8	17DT (TC4EE1), X17DT (TC4EE1)	01-1993 →, M →: 855.806	81746
1.8 i	66	03/92 → 09/98	1.796	B	M	4	8	C18NZ	→ 10-1992, → M: 14.254.438	81606
	66	03/92 → 09/98	1.796	B	M	4	8	C18NZ	11-1992 →, M →: 14.254.439	81551
1.8 i 16V	85	11/94 → 09/98	1.799	B	M	4	16	C18XEL, X18XE		81550
	92	06/93 → 10/94	1.799	B	M	4	16	C18XE		81550
2.0 GSI 16V	110	09/91 → 01/98	1.998	B	M	4	16	C20XE	01-1993 →, M →: 14.142.840	81550
2.0 i	85	09/91 → 07/94	1.998	B	M	4	8	C20NE	01-1992 →, M →: 14.608.701	81551
	85	03/92 → 09/98	1.998	B	M	4	8	C20NE	→ 10-1992, → M: 14.608.700	81606
	85	03/92 → 09/98	1.998	B	M	4	8	C20NE	11-1992 →, M →: 14.608.701	81551
	85	03/93 → 10/94	1.998	B	M	4	8	C20NE	→ M: 14.608.700	81606
	85	03/93 → 10/94	1.998	B	M	4	8	C20NE	M →: 14.608.701	81551
2.0 i 16V	100	02/95 → 09/98	1.998	B	M	4	16	X20XEV		81550
	110	03/93 → 01/98	1.998	B	M	4	16	C20XE	M →: 14.142.840	81550

**Astra G, Station Wagon, Coupé, Cabrio, Van**

1.2 16V	48	02/98 → 09/00	1.199	B	M	4	16	X12XE		81749
	55	09/00 → 01/05	1.199	B	M	4	16	Z12XE		81749
1.4	66	09/07 → 12/09	1.364	B	M	4	16	Z14XEP		82011

**KW**

**cm<sup>3</sup>**

**NO. OF VALVES**

**OPEL**
**Astra G, Station Wagon, Coupé, Cabrio, Van**

1.4 16V	66	02/98 → 01/05	1.389	B	M	4	16	X14XE, Z14XE	→ 08-2000, → M: 20U75998, → M: 02MV7224, → M: 20U75998	82005
	66	02/98 → 01/05	1.389	B	M	4	16	X14XE, Z14XE	09-2000 →, M →: 20U75999, M →: 02MV7225, M →: 20U75999	81817
	66	09/98 → 01/05	1.389	B	M	4	16	X14XE, Z14XE	09-2000 →	81818
	66	09/98 → 01/05	1.389	B	M	4	16	X14XE, Z14XE		82005
1.6	55	02/98 → 09/00	1.598	B	M	4	8	X16SZR		81549
	55	09/98 → 09/00	1.598	B	M	4	8	X16SZR	09-1996 →	81549
	62	09/00 → 01/05	1.598	B	M	4	8	Z16SE	→ M: 02MZ5253, → M: 20U75998	81549
	62	09/00 → 01/05	1.598	B	M	4	8	Z16SE	M →: 02MZ5254, M →: 20U75999	81818
	62	09/00 → 04/05	1.598	B	M	4	8	Z16SE	→ M: 20U75998, → M: 02MZ5253	81549
	62	09/00 → 07/04	1.598	B	M	4	8	Z16SE	M →: 20U75999, M →: 02MZ5254	81818
	76	12/02 → 12/09	1.598	B	M	4	16	Z16XEP		82083
	76	12/02 → 12/09	1.598	B	M	4	16	Z16XEP		81818
1.6 16V	74	02/98 → 01/05	1.598	B	M	4	16	C16SEL, X16XEL, Z16XE	→ M: 02MV7224, → M: 20U75998	82005
	74	02/98 → 01/05	1.598	B	M	4	16	C16SEL, X16XEL, Z16XE	M →: 02MV7225, M →: 20U75999	81817
	74	02/98 → 07/04	1.598	B	M	4	16	X16XEL, Z16XE	→ M: 02MV7224, → M: 20U75998	82005
	74	02/98 → 07/04	1.598	B	M	4	16	X16XEL, Z16XE	M →: 02MV7225, M →: 20U75999	81817
	74	09/98 → 01/05	1.598	B	M	4	16	X16XEL, Z16XE	09-2000 →	81818
	74	09/98 → 01/05	1.598	B	M	4	16	X16XEL, Z16XE		82005
	74	03/01 → 10/05	1.598	B	M	4	16	Z16XE	→ M: 02MV7224, → M: 20U75998	82005
	74	03/01 → 10/05	1.598	B	M	4	16	Z16XE	M →: 02MV7225, M →: 20U75999	81817
	74	03/00 → 05/05	1.598	B	M	4	16	Z16XE		81817
	74	03/00 → 05/05	1.598	B	M	4	16	Z16XE		82005
1.6 CNG	71	03/03 → 07/04	1.598		M	4	16	Z16YNG		81817
1.6 LPG	74	06/02 → 01/05	1.598		M	4	16	Z16XE		81817
	74	06/02 → 01/05	1.598		M	4	16	Z16XE		82005
1.7 CDTI	59	04/03 → 12/09	1.686	D	M	4	16	Z17DTL		81836

**KW**

**cm<sup>3</sup>**

**NO. OF VALVES**

**OPEL**
**Astra G, Station Wagon, Coupé, Cabrio, Van**

1.7 DTI 16V	55	02/00 → 01/05	1.686	D	M	4	16	Y17DT	→ 09-2000, → M: 073532	81746
	55	02/00 → 01/05	1.686	D	M	4	16	Y17DT	09-2000 →, M →: 073533	81836
	55	02/00 → 01/05	1.686	D	M	4	16	Y17DT		81836
	55	02/00 → 07/04	1.686	D	M	4	16	Y17DT	→ 08-2000, → M: 073532	81746
1.7 TD	50	02/98 → 08/00	1.700	D	M	4	8	X17DTL		81550
	50	09/98 → 08/00	1.700	D	M	4	8	X17DTL		81687
1.8 16V	85	02/98 → 09/00	1.796	B	M	4	16	X18XE1		81751
	85	09/98 → 09/00	1.796	B	M	4	16	X18XE1		81550
	92	09/00 → 01/05	1.796	B	M	4	16	Z18XE		81751
2.0 16V	100	02/98 → 01/05	1.998	B	M	4	16	C20SEL, X20XEV		81550
	100	02/98 → 07/04	1.998	B	M	4	16	X20XEV		81550
	100	09/98 → 01/05	1.998	B	M	4	16	X20XEV	M →: 14.142.840	81550
2.0 16V OPC	118	11/99 → 09/02	1.998	B	M	4	16	X20XER		81550
2.0 16V Turbo	140	09/00 → 08/01	1.998	B	M	4	16	Z20LET		81550
	141	08/01 → 05/05	1.998	B	M	4	16	Z20LET		81550
	147	11/02 → 10/05	1.998	B	M	4	16	Z20LER, Z20LET		81550
	147	11/02 → 05/05	1.998	B	M	4	16	Z20LET		81550
2.0 DI	60	01/99 → 04/05	1.995	D	M	4	16	X20DTL		81747
	60	02/98 → 01/05	1.995	D	M	4	16	X20DTL, Y20DTL		81747
2.0 DTI 16V	74	08/99 → 01/05	1.995	D	M	4	16	X20DTH, Y20DTH		81747
2.0 OPC	141	09/02 → 01/05	1.998	B	M	4	16	Z20LET		81550
	147	11/02 → 01/05	1.998	B	M	4	16	Z20LET		81550
2.2 16V	108	06/00 → 01/05	2.198	B	M	4	16	Z22SE		81812
2.2 DTI	86	09/02 → 01/05	2.172	D	M	4	16	Y22DTR		81747
	92	09/02 → 01/05	2.172	D	M	4	16	Y22DTR		81747

**Astra H, Station Wagon, GTC, Twin Top, Van**

1.2	59	08/05 →	1.229	B	M	4	16	Z12XEP		82011
1.3 CDTI	66	08/05 →	1.248	D	M	4	16	Z13DTH		81862
1.4	55	04/04 → 10/04	1.364	B	M	4	16	Z14XEL		82011
	59	04/04 → 10/04	1.364	B	M	4	16	Z14XEL		82011
	66	03/04 →	1.364	B	M	4	16	Z14XEP		82011
1.4 LPG	66	08/09 →	1.364		M	4	16	Z14XEP		82011
1.6	76	02/04 → 11/04	1.598	B	M	4	16	Z16XEP		82083
	77	03/04 →	1.598	B	M	4	16	Z16XE1, Z16XEP		82083
	85	12/06 →	1.598	B	M	4	16	A16XER, Z16XER		82083
	85	12/06 →	1.598	B	M	4	16	Z16XER		82083
1.6 LPG	85	08/09 →	1.598		M	4	16	Z16XER		82083
1.6 Turbo	132	02/07 →	1.598	B	M	4	16	Z16LET		82083





KW



cm<sup>3</sup>



NO. OF VALVES



**OPEL**

**Astra H, Station Wagon, GTC, Twin Top, Van**

1.7 CDTI	59	03/04 →	1.686	D	M	4	16	Z17DTL		81836
	59	03/05 →	1.686	D	M	4	16	Z17DTL		84005
	74	03/04 →	1.686	D	M	4	16	Z17DTH	→ T: 1874032	81836
	74	03/04 →	1.686	D	M	4	16	Z17DTH	T →: 1874033	84005
	74	03/04 →	1.686	D	M	4	16	Z17DTH		81836
	74	03/04 →	1.686	D	M	4	16	Z17DTH		84005
	81	02/07 →	1.686	D	M	4	16	A17DTJ		81836
	81	02/07 →	1.686	D	M	4	16	A17DTJ, Z17DTJ		81836
	81	02/07 →	1.686	D	M	4	16	A17DTJ, Z17DTJ		84005
	81	02/07 →	1.686	D	M	4	16	Z17DTJ		81836
	81	02/07 →	1.686	D	M	4	16	Z17DTJ		84005
	92	02/07 →	1.686	D	M	4	16	A17DTR		81836
	92	02/07 →	1.686	D	M	4	16	A17DTR, Z17DTR		81836
	92	02/07 →	1.686	D	M	4	16	A17DTR, Z17DTR		84005
1.8	92	03/04 →	1.796	B	M	4	16	Z18XE		82083
	103	01/06 →	1.796	B	M	4	16	A18XER, Z18XER		82083
	103	01/06 →	1.796	B	M	4	16	Z18XER		82083
1.9 CDTI	74	09/05 →	1.910	D	M	4	8	Z19DTL		81352
	88	06/04 →	1.910	D	M	4	8	Z19DT		81352
	110	09/04 →	1.910	D	M	4	16	Z19DTH		81872
1.9 CDTI 16V	88	04/04 →	1.910	D	M	4	16	Z19DTJ		81872
2.0 Turbo	125	03/04 →	1.998	B	M	4	16	Z20LEL		81550
	147	09/04 →	1.998	B	M	4	16	Z20LER		81550
	177	03/05 →	1.998	B	M	4	16	Z20LEH		81550

**Astra J, Station Wagon, GTC**

1.3 CDTI	70	12/09 →	1.248	D	M	4	16	A13DTE		81862
1.4	88	10/11 →	1.364	B	M	4	16	A14NEL, B14NEL		84027 <b>NEW</b>
	103	10/11 →	1.364	B	M	4	16	A14NET, B14NET		84027 <b>NEW</b>
	64	12/09 →	1.398	B	M	4	16	A14XEL		84027 <b>NEW</b>
	74	10/11 →	1.398	B	M	4	16	A14XER		84027 <b>NEW</b>
1.4 LPG	103	01/12 →	1.364		M	4	16	A14NET		84027 <b>NEW</b>
1.4 Turbo	88	10/10 →	1.364	B	M	4	16	A14NEL, B14NEL		84027 <b>NEW</b>
	103	12/09 →	1.364	B	M	4	16	A14NET		84027 <b>NEW</b>
	103	10/10 →	1.364	B	M	4	16	A14NET, B14NET		84027 <b>NEW</b>
1.6	85	12/09 →	1.598	B	M	4	16	A16XER, B16XER		82083
	132	10/11 →	1.598	B	M	4	16	A16LET		82083
1.6 Turbo	132	12/09 →	1.598	B	M	4	16	A16LET		82083
1.7 CDTI	74	10/10 →	1.686	D	M	4	16	A17DTL, A17DTN		84005
	81	10/11 →	1.686	D	M	4	16	A17DTC, A17DTE, A17DTJ		84005
	92	12/09 →	1.686	D	M	4	16	A17DTR		84005
	96	10/11 →	1.686	D	M	4	16	A17DTF, A17DTS		84005
1.8	103	10/11 →	1.796	B	M	4	16	A18XER		82083
2.0	206	04/12 →	1.998	B	M	4	16	A20NFT, B20NFT		81812

**KW**

**cm<sup>3</sup>**

**NO. OF  
VALVES**

**MAGNETI  
MARELLI**
**OPEL**
**Astra J, Station Wagon, GTC**

2.0 BiTurbo CDTI	143	12/12 →	1.956	D	M	4	16	A20DTR		81872
2.0 CDTI	96	10/10 →	1.956	D	M	4	16			81872
	118	12/09 →	1.956	D	M	4	16	A20DTH		81872
	121	10/11 →	1.956	D	M	4	16	A20DTH		81872

**Astra K, Sports Tourer**

1.4	74	06/15 →	1.399	B	M	4	16	B14XE		84053	<b>NEW</b>
-----	----	---------	-------	---	---	---	----	-------	--	-------	------------

**Calibra**

2.0 i	85	06/90 → 07/97	1.998	B	M	4	8	C20NE	→ 12-1992, → M: 14.608.700	81606
	85	06/90 → 07/97	1.998	B	M	4	8	C20NE	01-1993 →, M →: 14.608.701	81551
2.0 i 16V	100	02/94 → 07/97	1.998	B	M	4	16	X20XEV	M →: 14.142.840	81550
	110	06/90 → 02/94	1.998	B	M	4	16	C20XE	01-1993 →, M →: 14.142.839	81550
2.0 i 16V 4x4	100	02/94 → 07/97	1.998	B	M	4	16	X20XEV	M →: 14.142.840	81550
	110	06/90 → 02/94	1.998	B	M	4	16	C20XE	01-1993 →, M →: 14.142.839	81550
2.0 i 4x4	85	06/90 → 07/97	1.998	B	M	4	8	C20NE	→ 12-1992, → M: 14.608.700	81606
	85	06/90 → 07/97	1.998	B	M	4	8	C20NE	01-1993 →, M →: 14.608.701	81551
2.0 i Turbo 4x4	150	03/92 → 07/97	1.998	B	M	4	16	C20LET	01-1993 →, M →: 14.002.935	81550
2.5 i V6	125	04/93 → 07/97	2.498	B	M	6	24	C25XE, X25XE		81846

**Cascade (W13)**

1.4	88	03/13 →	1.362	B	M	4	16	A14NEL		84027	<b>NEW</b>
1.4 Turbo	103	03/13 →	1.362	B	M	4	16	A14NET		84027	<b>NEW</b>
2.0 CDTI	121	03/13 →	1.956	D	M	4	16	A20DTH		81872	
	143	03/13 →	1.956	D	M	4	16	A20DTR		81872	

**Combo A**

1.2	33	07/94 → 10/01	1.195	B	M	4	8	C12NZ, X12SZ		81549	
1.4	44	07/94 → 10/01	1.389	B	M	4	8	C14NZ, X14SZ	09-1995 →, → 08-1996	81549	
	60	07/94 → 10/01	1.389	B	M	4	8	C14SE		81549	
1.4 16V	66	08/99 → 10/01	1.389	B	M	4	16	X14XE		84027	<b>NEW</b>
	66	08/99 → 10/01	1.389	B	M	4	16	X14XE		82005	
1.7 D	44	07/94 → 10/01	1.686	D	M	4	8	17D(4EE1), X17D(4EE1)	→ M: 877.697	81687	
	44	07/94 → 10/01	1.686	D	M	4	8	17D(4EE1), X17D(4EE1)	M →: 877.698	81746	

**Combo B**

1.3 CDTI 16V	51	10/04 →	1.248	D	M	4	16	Y13DT, Z13DT		81862
	51	08/05 →	1.248	D	M	4	16	Z13DT		81862
	55	10/05 →	1.248	D	M	4	16	Z13DTJ		81862
1.4	66	10/04 →	1.364	B	M	4	16	Z14XEP		81836
1.4 16V	66	08/05 →	1.364	B	M	4	16	Z14XEP		82011

**KW**

**cm<sup>3</sup>**

**NO. OF VALVES**

**OPEL**
**Combo B**

1.6	64	10/01 →	1.598	B	M	4	8	Z16SE	M: Z16SE	81818
	64	10/01 →	1.598	B	M	4	8	Z16SE		81818
1.6 CNG	69	06/06 →	1.598		M	4	16	Z16YNG		81817
	71	04/05 →	1.598		M	4	16	Z16YNG		81817
1.6 CNG 16V	69	06/06 →	1.598		M	4	16	Z16YNG		81817
	71	04/05 →	1.598		M	4	16	Z16YNG		81817
1.7 CDTI 16V	74	12/04 →	1.686	D	M	4	16	Z17DTH		81836
1.7 DI 16V	48	10/01 →	1.686	D	M	4	16	Y17DTL		81836
1.7 DTI 16V	55	10/01 →	1.686	D	M	4	16	Y17DT		81836

**Combo C**

1.3 CDTI	66	02/12 →	1.248	D	M	4	16	A13FD		81862
1.4	70	02/12 →	1.368	B	M	4	16	A14FP	TESMA	82070
1.4 CNG	88	02/12 →	1.368		M	4	16	A14FC	TESMA	82070
1.6 CDTI	66	02/12 →	1.598	D	M	4	16	A16FDL		81872
	74	02/12 →	1.598	D	M	4	16	A16FDH		81872
	77	02/12 →	1.598	D	M	4	16	A16FDH		81872
2.0 CDTI	99	02/12 →	1.956	D	M	4	16	A20FD		81872

**Corsa A, Van**

1.0	33	09/82 → 03/93	993	B	M	4	8	10S		81544
1.2	33	09/82 → 08/90	1.196	B	M	4	8	12NC, E12GV		81544
	44	09/82 → 08/90	1.196	B	M	4	8	12S		81549
1.2 i	33	09/89 → 03/93	1.195	B	M	4	8	C12NZ		81549
1.2 N	38	01/90 → 03/93	1.196	B	M	4	8	12NV		81549
1.2 S	40	09/82 → 02/90	1.196	B	M	4	8	12ST		81549
1.3 GL	55	09/82 → 03/93	1.297	B	M	4	8	13S		81543
1.3 i	44	09/86 → 09/90	1.297	B	M	4	8	C13N		81543
1.4 i	44	01/90 → 03/93	1.389	B	M	4	8	C14NZ	→ M: 19.311.737	81681
	44	01/90 → 03/93	1.389	B	M	4	8	C14NZ	M →: 19.311.738	81549
1.4 S	53	01/90 → 03/93	1.389	B	M	4	8	14NV	→ M: 19.307.806	81681
	53	01/90 → 03/93	1.389	B	M	4	8	14NV	M →: 19.307.807	81549
1.4 Si	60	09/91 → 03/93	1.389	B	M	4	8	C14SE		81549
1.5 D	37	09/87 → 03/93	1.488	D	M	4	8	15D (4EC1)	→ 08-1990, M →: 804.795, → M: 909.999	81687
	37	09/87 → 03/93	1.488	D	M	4	8	15D (4EC1)	→ M: 804.794	81684
	37	09/87 → 03/93	1.488	D	M	4	8	15D (4EC1)	09-1990 →, M →: 910.000	81685
1.5 TD	49	03/88 → 03/93	1.488	D	M	4	8	15DT (T4EC1)	→ 08-1990, M →: 804.795, → M: 909.999	81687
	49	03/88 → 03/93	1.488	D	M	4	8	15DT (T4EC1)	→ M: 804.794	81684
	49	03/88 → 03/93	1.488	D	M	4	8	15DT (T4EC1)	09-1990 →, M →: 910.000	81685

**KW**

**cm<sup>3</sup>**

**NO. OF VALVES**

**OPEL**
**Corsa A, Van**

1.6 GSI	55	08/88 → 09/92	1.598	B	M	4	8	C16NZ	→ T: 02J22349	81681
	55	08/88 → 09/92	1.598	B	M	4	8	C16NZ	T →: 02J22350	81549
	72	09/89 → 03/93	1.598	B	M	4	8	C16SEI	→ M: 19.311.738	81681
	72	09/89 → 03/93	1.598	B	M	4	8	C16SEI	M →: 19.311.739	81549
	74	05/88 → 03/92	1.598	B	M	4	8	E16SE	→ T: 02J22349	81681
	74	05/88 → 03/92	1.598	B	M	4	8	E16SE	T →: 02J22350	81549
1.6 GSI Cat.	74	02/92 → 03/93	1.598	B	M	4	8	C16SE		81549

**Corsa B, Station Wagon, Van**

1.0 i 12V	40	11/96 → 09/00	973	B	M	3	12	X10XE		81749
1.2 i	33	03/93 → 09/00	1.195	B	M	4	8	12NZ, C12NZ, X12SZ		81549
1.2 i 16V	48	03/98 → 09/00	1.199	B	M	4	16	X12XE		81749
1.4	54	04/93 → 08/94	1.389	B	M	4	8	C14SE		81549
1.4 i	40	03/93 → 09/00	1.389	B	M	4	8	C14NZ, X14SZ		81549
	44	03/93 → 09/00	1.389	B	M	4	8	C14NZ, X14SZ		81549
1.4 i 16V	63	08/97 → 09/00	1.389	B	M	4	16	C14SEL		82005
	66	09/94 → 09/00	1.389	B	M	4	16	X14XE		82005
	67	09/94 → 09/00	1.389	B	M	4	16	X14XE		82005
1.4 Si	60	03/93 → 09/00	1.389	B	M	4	8	C14SE		81549
1.5 D	37	03/93 → 09/00	1.488	D	M	4	8	15D (4EC1)	→ 08-1994, → M: 877.697	81685
	37	03/93 → 09/00	1.488	D	M	4	8	15D (4EC1)	09-1994 →, M →: 877.698	81748
1.5 TD	49	03/93 → 09/00	1.488	D	M	4	8	15DT (T4EC1), X15DT (T4EC1)	→ 08-1994, M →: 877.698, → M: 076.350	81748
	49	03/93 → 09/00	1.488	D	M	4	8	15DT (T4EC1), X15DT (T4EC1)	→ M: 877.697	81685
	49	03/93 → 09/00	1.488	D	M	4	8	15DT (T4EC1), X15DT (T4EC1)	09-1994 →, M →: 076.351	81750
1.6 GSI 16V	80	03/93 → 09/00	1.598	B	M	4	16	C16XE		82005
1.6 i 16V	74	08/97 → 09/00	1.598	B	M	4	16	C16SEL		82005
	78	09/94 → 09/00	1.598	B	M	4	16	X16XE		82005
1.7 D	44	02/96 → 09/00	1.686	D	M	4	8	17D (4EE1), X17D (4EE1)	→ M: 877.697	81687
	44	02/96 → 09/00	1.686	D	M	4	8	17D (4EE1), X17D (4EE1)	M →: 877.698	81746
	44	08/99 → 09/00	1.686	D	M	4	8	17D (4EE1), X17D (4EE1)		81746
	44	01/99 →	1.686	D	M	4	8	X17D (4EE1)		81746
	44	01/99 →	1.686	D	M	4	8	X17D (4EE1)		81847

**Corsa C, Van**

1.0	43	09/00 → 06/03	973	B	M	3	12	Z10XE		81749
	44	06/03 → 12/09	998	B	M	3	12	Z10XEP		82011
1.2	55	09/00 → 12/09	1.199	B	AM	4	16	Z12XE		81749
	59	07/05 →	1.229	B	M	4	16	Z12XEP		82011
1.2 16V	55	09/00 →	1.199	B	M	4	16	Z12XE		81749
1.2 Twinport	59	07/04 → 12/09	1.229	B	M	4	16	Z12XEP		82011

	KW		cm <sup>3</sup>				NO. OF VALVES		
--	----	--	-----------------	--	--	--	---------------	--	--

## OPEL

### Corsa C, Van

1.3 CDTI	51	06/03 → 12/09	1.248	D	M	4	16	Z13DT		81862
1.3 CDTI 16V	51	08/05 →	1.248	D	M	4	16	Z13DT		81862
1.4	66	08/03 →	1.364	B	M	4	16	Z14XEP		82011
	66	09/00 → 12/09	1.389	B	M	4	16	Z14XE		81817
1.4 Twinport	66	06/03 → 12/09	1.364	B	M	4	16	Z14XEP		82011
1.7 CDTI	74	06/03 → 12/09	1.686	D	M	4	16	Z17DTH		81836
1.7 DI	48	09/00 → 12/09	1.686	D	M	4	16	Y17DTL		81836
1.7 DI 16V	48	09/00 →	1.686	D	M	4	16	Y17DTL		81836
1.7 DTI	55	09/00 → 12/09	1.686	D	M	4	16	Y17DT		81836
1.7 DTI 16V	55	09/00 →	1.686	D	M	4	16	Y17DT		81836
1.8	92	09/00 → 12/09	1.796	B	M	4	16	Z18XE		81751

### Corsa D, Van

1.0	44	07/06 →	998	B	M	3	12	A10XEP		82011
	44	07/06 →	998	B	M	3	12	Z10XEP		82011
	48	01/10 →	998	B	M	3	12	A10XEP		82011
1.2	51	06/10 →	1.229	B	M	4	16	A12XEL		84027 <b>NEW</b>
	59	07/06 →	1.229	B	M	4	16	Z12XEP		82011
	63	06/10 →	1.229	B	M	4	16	A12XER		84027 <b>NEW</b>
1.2 LPG	55	09/09 →	1.229		M	4	16	Z12XEP		82011
	59	09/09 →	1.229		M	4	16	Z12XEP		82011
	61	06/11 →	1.229		M	4	16	A12XER		84027 <b>NEW</b>
	63	08/11 →	1.229		M	4	16	A12XER		84027 <b>NEW</b>
1.3 CDTI	55	07/06 →	1.248	D	M	4	16	A13DTC, Z13DTJ		81862
	66	07/06 →	1.248	D	M	4	16	Z13DTH		81862
	70	06/10 →	1.248	D	M	4	16	A13DTE, A13DTR, Z13DTE		81862
1.4	66	07/06 →	1.364	B	M	4	16	Z14XEP		82011
	88	07/12 →	1.364	B	M	4	16	A14NEL		84027 <b>NEW</b>
	64	09/09 →	1.398	B	M	4	16	A14XEL		84027 <b>NEW</b>
	74	06/10 →	1.398	B	M	4	16	A14XER		84027 <b>NEW</b>
1.4 LPG	66	07/06 →	1.364		M	4	16	Z14XEP		82011
	64	09/09 →	1.398		M	4	16	A14XEL		84027 <b>NEW</b>
1.6 Turbo	110	02/07 →	1.598	B	M	4	16	A16LEL, Z16LEL		82083
	141	02/07 →	1.598	B	M	4	16	A16LER, B16LER, Z16LER		82083
	155	06/11 →	1.598	B	M	4	16	A16LES, B16LES		82083
1.7 CDTI	92	07/06 →	1.686	D	M	4	16	Z17DTR	→ T: 1874032	81836
	92	07/06 →	1.686	D	M	4	16	Z17DTR	T →: 1874033	84005
	96	06/10 →	1.686	D	M	4	16	A17DTS	→ T: 1874032	81836
	96	06/10 →	1.686	D	M	4	16	A17DTS	T →: 1874033	84005

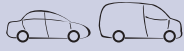
**KW**

**cm<sup>3</sup>**

**NO. OF VALVES**

**MAGNETI MARELLI**
**OPEL**
**Corsa E, Van**

1.2	51	09/14 →	1.229	B	M	4	16	B12XEL		84027	<b>NEW</b>
1.3 CDTI	55	09/14 →	1.248	D	M	4	16	B13DTC		81862	
1.4	55	09/14 →	1.398	B	M	4	16	B14XEJ		84027	<b>NEW</b>
	66	09/14 →	1.398	B	M	4	16	B14XEL		84027	<b>NEW</b>
1.4 LPG	66	03/15 →	1.398		M	4	16	B14XEL		84027	<b>NEW</b>
1.4 Turbo	74	09/14 →	1.364	B	M	4	16	B14NEJ		84027	<b>NEW</b>
	110	03/15 →	1.364	B	M	4	16	B14NEH		84027	<b>NEW</b>
1.6 Turbo	152	03/15 →	1.598	B	M	4	16	B16LES		82083	

**Frontera A**

2.0 i	85	03/92 → 10/98	1.998	B	M	4	8	C20NE, X20SE	M: C20NE	81606	
	85	03/92 → 10/98	1.998	B	M	4	8	C20NE, X20SE	M: X20SE	81551	
2.2 i	100	03/95 → 10/98	2.198	B	M	4	16	X22XE		81550	
2.5 TDS	85	09/96 → 10/98	2.499	D	M	4	8	25TDS (VM41B)	(-)COP	81362	

**Frontera B**

2.2 DTI	88	09/02 →	2.171	D	M	4	16	Y22DTH		81747	
	85	10/98 → 09/02	2.171	D	M	4	16	X22DTH, Y22DTH		81747	
2.2 i	100	10/98 →	2.198	B	M	4	16	X22SE, Y22SE		81550	

**GT II**

2.0	194	06/07 →	1.998	B	M	4	16	LNF, Z20NHH	→ T: 7Y999999	81812	
-----	-----	---------	-------	---	---	---	----	-------------	---------------	-------	--

**Insignia, Station Wagon**

1.4	103	09/11 →	1.364	B	M	4	16	A14NET		84027	<b>NEW</b>
	103	04/11 →	1.364	B	M	4	16	A14NET, B14NET		84027	<b>NEW</b>
1.4 LPG	103	07/12 →	1.364		M	4	16	A14NET		84027	<b>NEW</b>
1.6	85	07/08 →	1.598	B	M	4	16	A16XER		82083	
1.6 Turbo	132	07/08 →	1.598	B	M	4	16	A16LET		82083	
1.8	103	07/08 →	1.796	B	M	4	16	A18XER		82083	
2.0 Biturbo CDTI	140	07/08 →	1.956	D	M	4	16	A20DTR		81872	
	143	01/12 →	1.956	D	M	4	16	A20DTR		81872	
2.0 Biturbo CDTI 4x4	140	05/09 →	1.956	D	M	4	16	A20DTR		81872	
	143	01/12 →	1.956	D	M	4	16	A20DTR		81872	
2.0 CDTI	81	07/08 →	1.956	D	M	4	16	A20DTC, A20DTL		81872	
	88	03/12 →	1.956	D	M	4	16	A20DTE		81872	
	96	07/08 →	1.956	D	M	4	16	A20DT, A20DTJ		81872	
	103	07/13 →	1.956	D	M	4	16	A20DTE		81872	
	118	07/08 →	1.956	D	M	4	16	A20DTH		81872	
	120	07/13 →	1.956	D	M	4	16	A20DTH		81872	
	125	11/14 →	1.956	D	M	4	16	B20DTH		81872	
2.0 CDTI 4x4	118	06/10 →	1.956	D	M	4	16	A20DTH		81872	
	120	07/13 →	1.956	D	M	4	16	A20DTH		81872	
2.0 E85 Turbo	162	09/10 →	1.998	FF	M	4	16	A20NFT, A20NHT		81812	
	162	09/10 →	1.998	FF	M	4	16	A20NHT		81812	
2.0 Turbo	162	07/08 →	1.998	B	M	4	16	A20NHT		81812	
2.0 Turbo 4x4	162	07/08 →	1.998	B	M	4	16	A20NHT		81812	
	184	09/11 →	1.998	B	M	4	16	A20NFT		81812	

		KW		cm <sup>3</sup>				NO. OF VALVES			
--	--	----	--	-----------------	--	--	--	---------------	--	--	--

## OPEL

### Insignia, Station Wagon

2.0 Turbo E85	162	07/08 →	1.998	FF	M	4	16	A20NFT, A20NHT		81812
2.8 V6 Turbo 4x4	191	07/08 →	2.792	B	M	6	24	A28NET		84057
2.8 V6 Turbo OPC 4x4	239	07/09 →	2.792	B	M	6	24	A28NER		84057

### Kadett E, Station Wagon, Coupé, Cabrio, Van

1.3 i Cat.	44	09/85 → 08/91	1.297	B	M	4	8	C13N		81543
1.3 N	44	09/84 → 08/91	1.297	B	M	4	8	13N		81543
	44	09/84 → 08/91	1.297	B	M	4	8	13N, 13NB		81543
1.3 S	55	03/87 → 02/93	1.297	B	M	4	8	13S		81543
1.4 i	44	01/90 → 08/91	1.389	B	M	4	8	C14NZ	→ M: 19.311.737	81681
	44	01/90 → 08/91	1.389	B	M	4	8	C14NZ	M →: 19.311.738	81549
1.4 S	55	01/90 → 08/91	1.389	B	M	4	8	14NV		81549
	60	09/89 → 08/91	1.389	B	M	4	8	C14SE	→ M: 19.311.737	81681
	60	09/89 → 08/91	1.389	B	M	4	8	C14SE	M →: 19.311.738	81549
1.5 TD	53	07/88 → 08/91	1.488	D	M	4	8	15DT (T4EC1)	→ M: 804.794	81684
	53	07/88 → 08/91	1.488	D	M	4	8	15DT (T4EC1)	M →: 804.795	81685
1.6	60	09/86 → 12/91	1.598	B	M	4	8	16SV	→ M: 19.311.737	81681
	60	09/86 → 12/91	1.598	B	M	4	8	16SV	M →: 19.311.738	81549
1.6 i	55	08/91 → 07/94	1.598	B	M	4	8	C16NZ	→ M: 19.311.737	81681
	55	08/91 → 07/94	1.598	B	M	4	8	C16NZ	M →: 19.311.738	81549
	55	09/86 → 08/91	1.598	B	M	4	8	E16NZ	→ M: 19.311.737	81681
	55	09/86 → 08/91	1.598	B	M	4	8	E16NZ	M →: 19.311.738	81549
	60	07/89 → 02/93	1.598	B	M	4	8	16SV	→ M: 19.311.737	81681
	60	07/89 → 02/93	1.598	B	M	4	8	16SV	M →: 19.311.738	81549
1.6 i Cat.	55	09/86 → 08/91	1.598	B	M	4	8	C16LZ, C16NZ	→ M: 19.311.737	81681
	55	09/86 → 08/91	1.598	B	M	4	8	C16LZ, C16NZ	M →: 19.311.738	81549
1.6 S	60	09/86 → 08/91	1.598	B	M	4	8	16SV	→ M: 19.311.737	81681
	60	09/86 → 08/91	1.598	B	M	4	8	16SV	M →: 19.311.738	81549
1.7 D	42	02/89 → 08/91	1.700	D	M	4	8	17D	09-1989 →, → 05-1992	81605
	42	02/89 → 08/91	1.700	D	M	4	8	17D		81605
	44	07/92 → 07/94	1.700	D	M	4	8	17DR		81605
1.8	84	09/87 → 08/90	1.796	B	M	4	8	18E	09-1988 →, M →: 14.237.770	81606
1.8 i	66	06/85 → 08/91	1.796	B	M	4	8	C18NT, C18NZ, S18NV		81606
1.8 S	62	09/87 → 08/91	1.796	B	M	4	8	E18NV		81606
	62	09/87 → 08/91	1.796	B	M	4	8	E18NV, S18NV		81606
	62	09/87 → 08/91	1.798	B	M	4	8	E18NV		81606
2.0 GSI	85	09/86 → 08/91	1.998	B	M	4	8	20NE		81606
	95	09/86 → 08/91	1.998	B	M	4	8	20SEH		81606
2.0 GSI Cat.	85	09/86 → 08/91	1.998	B	M	4	8	C20NE		81606
2.0 i	85	10/86 → 02/93	1.998	B	M	4	8	20NE		81606
	85	03/87 → 08/91	1.998	B	M	4	8	20NE, 20SE		81606
2.0 i Cat.	85	03/87 → 08/91	1.998	B	M	4	8	C20NE		81606



KW



cm<sup>3</sup>



NO. OF VALVES



MAGNETI MARELLI

## OPEL

### Karl

1.0	52	06/15 →	999	B	M	3	12	B10XL		84053	<b>NEW</b>
	55	01/15 →	999	B	M	3	12	B10XE		84053	<b>NEW</b>
1.0 LPG	54	02/15 →	999		M	3	12	B10XE		84053	<b>NEW</b>

### Meriva A

1.3 CDTI	51	04/05 → 05/10	1.248	D	M	4	16	Y13DT, Z13DT		81862	
	55	09/03 → 05/10	1.248	D	M	4	16	Z13DTJ		81862	
1.4 16V Twinport	66	07/04 → 05/10	1.364	B	M	4	16	Z14XEP		82011	
1.4 16V Twinport LPG	66	07/04 → 05/10	1.364		M	4	16	Z14XEP		82011	
1.6	64	05/03 → 05/10	1.598	B	M	4	8	Z16SE		81818	
	77	01/06 → 05/10	1.598	B	M	4	16	Z16XEP		82083	
1.6 16V	74	05/03 → 01/06	1.598	B	M	4	16	Z16XE		81817	
1.6 Turbo	132	09/05 → 05/10	1.598	B	M	4	16	Z16LET		82083	
1.7 CDTI	74	09/03 → 05/10	1.686	D	M	4	16	Z17DT, Z17DTH		81836	
	92	09/06 → 05/10	1.686	D	M	4	16	A17DTR, Z17DTR		81836	
1.7 DTI	55	09/03 → 05/10	1.686	D	M	4	16	Y17DT		81836	
1.8	92	05/03 → 05/10	1.796	B	M	4	16	Z18XE		81751	

### Meriva B

1.3 CDTI	55	06/10 →	1.248	D	M	4	16	A13DTC		81862	
	70	06/10 →	1.248	D	M	4	16	A13DTE		81862	
1.4	88	06/10 →	1.364	B	M	4	16	A14NEL, B14NEL		84027	<b>NEW</b>
	103	06/10 →	1.364	B	M	4	16	A14NET, B14NET		84027	<b>NEW</b>
	74	06/10 →	1.398	B	M	4	16	A14XER, B14XER		84027	<b>NEW</b>
1.4 LPG	88	06/11 →	1.364		M	4	16	A14NEL, B14NEL		84027	<b>NEW</b>
1.7 CDTI	74	06/10 →	1.686	D	M	4	16	A17DT		84005	
	81	06/10 →	1.686	D	M	4	16	A17DTC, A17DTI		84005	
	96	06/10 →	1.686	D	M	4	16	A17DTS		84005	

### Mokka

1.4	103	04/13 →	1.364	B	M	4	16	A14NET, B14NET		84027	<b>NEW</b>
1.4 4x4	103	06/12 →	1.364	B	M	4	16	A14NET, B14NET		84027	<b>NEW</b>
1.4 LPG	103	04/13 →	1.364		M	4	16	A14NET		84027	<b>NEW</b>
1.6	85	06/12 →	1.598	B	M	4	16	A16XER, B16XER		82083	
1.7 CDTI	96	06/12 →	1.686	D	M	4	16	A17DTS		84005	
1.7 CDTI 4x4	96	06/12 →	1.686	D	M	4	16	A17DTS		84005	
1.8	103	01/13 →	1.796	B	M	4	16	A18XER		82083	
1.8 4x4	103	01/13 →	1.796	B	M	4	16	A18XER		82083	

### Movano A

1.9 DTI	59	09/00 → 10/01	1.870	D	M	4	8	F9Q770		81574	
	60	10/01 →	1.870	D	M	4	8	F9Q772, F9Q774		81814	
	60	10/01 →	1.870	D	M	4	8	F9Q772, F9Q774		84009	
2.2 DTI	66	09/00 →	2.188	D	M	4	16	G9T720, G9T722, G9T750		81855	
2.5 CDTI	74	09/07 →	2.464	D	M	4	16	G9U650		81855	
	88	08/06 →	2.464	D	M	4	16	G9U632, G9U650		81855	
	107	08/06 →	2.464	D	M	4	16	G9U632, G9U650		81855	



--	--	--	--	--	--	--	--	--	--

## OPEL

### Movano A

2.5 D	59	07/98 → 09/00	2.499	D	M	4	8	S8U770, S8U772		81834
2.5 DTi	73	10/03 →	2.463	D	M	4	16	G9U754		81855
	84	10/01 →	2.463	D	M	4	16	G9U720, G9U724, G9U750, G9U754		81855
	84	10/01 →	2.463	D	M	4	16	G9U720, G9U724, G9U754		81855
2.8 DTI	84	07/98 → 10/01	2.799	D	M	4	8	S9W700, S9W702		81835
	84	01/99 → 10/01	2.799	D	M	4	8	S9W700, S9W702	→ 12-1999	81834
	84	01/99 → 10/01	2.799	D	M	4	8	S9W700, S9W702	01-2000 →	81835

### Movano B

2.3 CDTI	74	12/10 →	2.298	D	M	4	16	M9T670, M9T672, M9T676		82069
	92	12/10 →	2.298	D	M	4	16	M9T670, M9T672, M9T676, M9T680, M9T876		82069
	107	12/10 →	2.298	D	M	4	16	M9T678, M9T680		82069
	110	01/13 →	2.298	D	M	4	16	M9T880		82069
2.3 CDTI [RWD]	74	05/10 →	2.298	D	M	4	16	M9T690, M9T692		82069
	92	05/10 →	2.298	D	M	4	16	M9T692, M9T696, M9T698, M9T876		82069
	107	05/10 →	2.298	D	M	4	16	M9T694, M9T696, M9T698		82069
2.3 CDTI FWD	74	05/10 →	2.298	D	M	4	16	M9T670, M9T672, M9T676		82069
	92	05/10 →	2.298	D	M	4	16	M9T670, M9T672, M9T676, M9T680, M9T876		82069
	92	05/10 →	2.298	D	M	4	16	M9T670, M9T672, M9T676, M9T876		82069
	107	05/10 →	2.298	D	M	4	16	M9T678, M9T680		82069
	110	01/13 →	2.298	D	M	4	16	M9T880		82069

### Omega A, Station Wagon

1.8	65	09/87 → 03/94	1.796	B	M	4	8	E18NVR		81606
	85	09/86 → 03/94	1.796	B	M	4	8	18SEH		81606
1.8 S	66	09/86 → 03/94	1.796	B	M	4	8	18SV		81606
2.0	73	09/90 → 03/94	1.998	B	M	4	8	C20NEJ		81551
	74	09/90 → 03/94	1.998	B	M	4	8	C20NEF	M →: 14.608.701	81551
	74	09/90 → 03/94	1.998	B	M	4	8	C20NEF		81551
	90	09/86 → 03/94	1.998	B	M	4	8	20SE	→ 12-1989, → M: 14.608.700	81606
	90	09/86 → 03/94	1.998	B	M	4	8	20SE	01-1990 →, M →: 14.608.701	81551
	90	09/86 → 03/94	1.998	B	M	4	8	20SE	01-1990 →, M →: 14608701	81551

**KW**

**cm<sup>3</sup>**

**NO. OF VALVES**

**OPEL**
**Omega A, Station Wagon**

2.0 i	73	09/90 → 03/94	1.998	B	M	4	8	C20NEJ		81551
	85	09/86 → 03/94	1.998	B	M	4	8	C20NE	→ 12-1989, → M: 14.608.700	81606
	85	09/86 → 03/94	1.998	B	M	4	8	C20NE	01-1990 →, M →: 14.608.701	81551

**Omega B, Station Wagon**

2.0	85	03/94 → 12/00	1.998	B	M	4	8	20SE, X20SE		81551
	85	03/94 → 09/99	1.998	B	M	4	8	X20SE		81551
2.0 16V	100	03/94 → 09/99	1.998	B	M	4	16	X20XEV		81550
2.0 DTI 16V	74	09/97 → 09/00	1.995	D	M	4	16	X20DTH		81747
2.2 16V	106	09/99 → 07/03	2.198	B	M	4	16	Y22XE, Z22XE		81550
2.2 DTI 16V	81	09/00 → 07/03	2.171	D	M	4	16	Y22DTH		81747
	88	09/00 → 07/03	2.171	D	M	4	16	Y22DTH		81747
2.5 D	96	05/94 → 05/99	2.498	D	M	6	12	X25TD		81597
2.5 DTI	110	09/01 → 07/03	2.497	D	M	6	24	Y25DT		81795
2.5 TD	96	04/94 → 07/03	2.497	D	M	6	12	25DT, X25DT, X25TD		81597
2.5 V6	125	03/94 → 09/00	2.498	B	M	6	24	X25XE		81846
2.6 V6	132	09/00 → 07/03	2.597	B	M	6	24	Y26SE		81846
3.0 V6	155	04/94 → 02/01	2.962	B	M	6	24	X30XE		81846
3.2 V6	160	02/01 → 07/03	3.175	B	M	6	24	Y32SE		81846

**Signum**

1.8	90	05/03 →	1.796	B	M	4	16	Z18XE		81751
	103	09/05 →	1.796	B	M	4	16	Z18XER		82083
1.9 CDTI	74	08/05 →	1.910	D	M	4	8	Z19DT		81352
	88	04/04 →	1.910	D	M	4	8	Z19DT		81352
	110	04/04 →	1.910	D	M	4	16	Z19DTH		81872
2.0 DTI	74	05/03 →	1.994	D	M	4	16	Y20DTH		81747
2.0 Turbo	129	05/03 →	1.998	B	M	4	16	Z20NET		81812
2.2 direct	114	05/03 →	2.198	B	M	4	16	Z22YH		81812
2.2 DTI	92	05/03 →	2.171	D	M	4	16	Y22DTR		81747
2.8 V6 Turbo	169	09/05 →	2.792	B	M	6	24	Z28NEL		84057 <b>NEW</b>
	184	01/06 →	2.792	B	M	6	24	Z28NET		84057 <b>NEW</b>
3.2 V6	155	05/03 →	3.175	B	M	6	24	Z32SE		81846

**Sintra**

2.2 DTI	85	07/97 → 04/99	2.171	D	M	4	16	X22DTH		81747
2.2 i 16V	104	11/96 → 04/99	2.198	B	M	4	16	X22XE		81550
3.0 i 24V	148	11/96 → 04/99	2.962	B	A	6	24	X30XE		81846

**Speedster**

2.0 Turbo	147	04/03 →	1.998	B	M	4	16	Z20LET		81550
2.2	108	09/00 →	2.198	B	M	4	16	Z22SE		81812

		<b>KW</b>		<b>cm<sup>3</sup></b>				<b>NO. OF VALVES</b>			<b>MAGNETI MARELLI</b>
--	--	-----------	--	-----------------------	--	--	--	----------------------	--	--	------------------------

**OPEL**
**Tigra I**

1.4 16V	63	08/97 → 12/00	1.389	B	M	4	16	X14XE		82005
	66	07/94 → 12/00	1.389	B	M	4	16	X14XE		82005
1.6 16V	74	08/97 → 08/98	1.598	B	M	4	16	C16SEL		82005
	78	07/94 → 08/98	1.598	B	M	4	16	X16XE		82005

**Tigra II Twin Top**

1.3 CDTI	51	06/04 →	1.248	D	M	4	16	Z13DT		81862
1.4	66	06/04 →	1.364	B	M	4	16	Z14XEP		82011
1.8	92	06/04 →	1.796	B	M	4	16	Z18XE		81751

**Vectra A**

1.4 S	55	09/88 → 06/92	1.389	B	M	4	8	14NV	→ M: 19.307.805	81681
	55	09/88 → 06/92	1.389	B	M	4	8	14NV	M →: 19.307.806	81549
1.6	60	09/88 → 05/93	1.598	B	M	4	8	16SV	→ M: 2.122.349	81681
	60	09/88 → 05/93	1.598	B	M	4	8	16SV	M →: 2.122.350	81549
1.6 i	52	09/93 → 11/95	1.598	B	M	4	8	X16SZ	→ M: 2.122.349	81681
	52	09/93 → 11/95	1.598	B	M	4	8	X16SZ	M →: 2.122.350	81549
	55	09/93 → 11/95	1.598	B	M	4	8	16LZ2	→ M: 2.122.349	81681
	55	09/93 → 11/95	1.598	B	M	4	8	16LZ2	M →: 2.122.350	81549
	55	09/88 → 11/95	1.598	B	M	4	8	16LZ2, C16LZ2, C16NZ, C16NZ2, E16NZ	→ M: 2.122.349	81681
	55	09/88 → 11/95	1.598	B	M	4	8	16LZ2, C16LZ2, C16NZ, C16NZ2, E16NZ	M →: 2.122.350	81549
1.6 i Cat.	55	09/88 → 11/95	1.598	B	M	4	8	C16NZ, C16NZ2	→ M: 2.122.349	81681
	55	09/88 → 11/95	1.598	B	M	4	8	C16NZ, C16NZ2	M →: 2.122.350	81549
1.6 S	60	09/88 → 05/93	1.598	B	M	4	8	16SV	→ M: 2.122.349	81681
	60	09/88 → 05/93	1.598	B	M	4	8	16SV	M →: 2.122.350	81549
1.7 D	42	10/88 → 09/92	1.700	D	M	4	8	17D	→ M: 14.333.449	81605
	42	10/88 → 09/92	1.700	D	M	4	8	17D	M →: 14.333.450	81550
	44	07/92 → 11/95	1.700	D	M	4	8	17DR	→ 12-1992, → M: 14.333.449	81605
	44	07/92 → 11/95	1.700	D	M	4	8	17DR	01-1993 →, M →: 14.333.450	81550
	44	07/92 → 11/95	1.700	D	M	4	8	17DR	M →: 14.333.450	81550
1.7 TD	60	03/90 → 11/95	1.686	D	M	4	8	17DT (TC4EE1), X17DT (TC4EE1)		81687
1.8 i	66	09/88 → 10/90	1.796	B	M	4	8	18SV	→ T: N5.999.999	81606
	66	09/88 → 10/90	1.796	B	M	4	8	18SV	T →: P1.000.001	81551
1.8 i Cat.	66	03/90 → 11/95	1.796	B	M	4	8	C18NZ	→ 12-1992, → T: N5.999.999	81606
	66	03/90 → 11/95	1.796	B	M	4	8	C18NZ	01-1993 →, T →: P1.000.001	81551
1.8 S	66	09/89 → 10/90	1.796	B	M	4	8	18SV	→ T: N5.999.999	81606
	66	09/89 → 10/90	1.796	B	M	4	8	18SV	T →: P1.000.001	81551

**KW**

**cm<sup>3</sup>**

**NO. OF VALVES**

**OPEL**
**Vectra A**

2.0 i	85	09/88 → 10/90	1.998	B	M	4	8	20NE	→ T: N5.999.999	<b>81606</b>
	85	09/88 → 10/90	1.998	B	M	4	8	20NE	T →: P1.000.001	<b>81551</b>
	95	09/88 → 09/92	1.998	B	M	4	8	20SEH	08-1988 →, → 12-1992, → T: N5.999.999	<b>81606</b>
	95	09/88 → 09/92	1.998	B	M	4	8	20SEH	T →: P1.000.001	<b>81551</b>
2.0 i 16V	100	06/94 → 11/95	1.998	B	M	4	16	X20XEV	M →: 14.142.839	<b>81550</b>
	110	02/89 → 10/90	1.998	B	M	4	16	20XEJ	M →: 14.142.839	<b>81550</b>
2.0 i 16V 4x4	100	06/94 → 11/95	1.998	B	M	4	16	X20XEV	M →: 14.142.839	<b>81550</b>
2.0 i 16V Cat.	110	02/90 → 11/95	1.998	B	M	4	16	C20XE	M →: 14.142.839	<b>81550</b>
2.0 i 4x4	85	01/89 → 10/90	1.998	B	M	4	8	20NE	→ T: N5.999.999	<b>81606</b>
	85	01/89 → 10/90	1.998	B	M	4	8	20NE	T →: P1.000.001	<b>81551</b>
	95	01/89 → 09/92	1.998	B	M	4	8	20SEH	08-1988 →, → 12-1992, → T: N5.999.999	<b>81606</b>
	95	01/89 → 09/92	1.998	B	M	4	8	20SEH	T →: P1.000.001	<b>81551</b>
2.0 i 4x4 Cat.	85	01/89 → 11/95	1.998	B	M	4	8	C20NE	08-1988 →, → 12-1992, → T: N5.999.999	<b>81606</b>
	85	01/89 → 11/95	1.998	B	M	4	8	C20NE	T →: P1.000.001	<b>81551</b>
2.0 i Cat.	85	09/88 → 11/95	1.998	B	M	4	8	C20NE	→ 12-1992, → T: N5.999.999	<b>81606</b>
	85	09/88 → 11/95	1.998	B	M	4	8	C20NE	01-1993 →, T →: P1.000.001	<b>81551</b>
2.0 i GT	95	09/88 → 11/95	1.998	B	M	4	8	20SEH	→ 12-1992, → T: N5.999.999	<b>81606</b>
	95	09/88 → 11/95	1.998	B	M	4	8	20SEH	01-1993 →, T →: P1.000.001	<b>81551</b>
2.0 i Turbo 4x4	150	06/94 → 11/95	1.998	B	M	4	16	C20LET	M →: 14.002.935	<b>81550</b>
2.5 V6	125	02/93 → 11/95	2.498	B	M	6	24	C25XE		<b>81846</b>
2000 16V 4x4	110	01/89 → 10/90	1.998	B	M	4	16	20XEJ	M →: 14.142.839	<b>81550</b>
2000/GT 16V	110	01/89 → 06/94	1.998	B	M	4	16	20XEJ	M →: 14.142.839	<b>81550</b>
2000/GT 16V 4x4 Cat.	110	02/90 → 11/95	1.998	B	M	4	16	C20XE	M →: 14.142.839	<b>81550</b>
2000/GT 16V Cat.	110	02/90 → 11/95	1.998	B	M	4	16	C20XE	M →: 14.142.839	<b>81550</b>

**Vectra B, Station Wagon**

1.6 i	55	10/95 → 04/02	1.598	B	M	4	8	16LZ2		<b>81551</b>
	55	10/95 → 04/02	1.598	B	M	4	8	X16SZR	→ 12-1999, → M: 02MZ5253	<b>81549</b>
	55	10/95 → 04/02	1.598	B	M	4	8	X16SZR	01-2000 →, M →: 02MZ5254	<b>81818</b>
	55	10/95 → 07/03	1.598	B	M	4	8	X16SZR	→ M: 02MZ5253	<b>81549</b>
	55	10/95 → 07/03	1.598	B	M	4	8	X16SZR	M →: 02MZ5254	<b>81818</b>

**KW**

**cm<sup>3</sup>**

**NO. OF VALVES**

**MAGNETI MARELLI**
**OPEL**
**Vectra B, Station Wagon**

1.6 i 16V	74	10/95 → 04/02	1.598	B	M	4	16	X16XEL, Y16XE, Z16XE	→ M: 20U75998, → M: 02MV7224	82005
	74	10/95 → 04/02	1.598	B	M	4	16	X16XEL, Y16XE, Z16XE	M →: 20U75999, M →: 02MV7225	81817
	74	10/95 → 07/02	1.598	B	M	4	16	X16XEL, Y16XE, Z16XE	→ M: 02MZ5253	82005
	74	10/95 → 07/02	1.598	B	M	4	16	X16XEL, Y16XE, Z16XE	M →: 02MZ5254	81817
	74	11/96 → 07/02	1.598	B	M	4	16	X16XEL, Y16XE, Z16XE	→ M: 20U75998, → M: 02MZ5253	82005
	74	11/96 → 07/02	1.598	B	M	4	16	X16XEL, Y16XE, Z16XE	M →: 20U75999, M →: 02MZ5254	81817
1.7 TD	60	10/95 → 12/98	1.686	D	M	4	8	X17DT (TC4EE1)		81746
	60	11/96 → 12/97	1.686	D	M	4	8	X17DT (TC4EE1)		81847
1.8 i 16V	85	10/95 → 09/00	1.796	B	M	4	16	X18XE1, Z18XEL	→ 12-1998, M: X18XE	81550
	85	10/95 → 09/00	1.796	B	M	4	16	X18XE1, Z18XEL	01-1999 →, M: X18XE1	81751
	92	09/00 → 04/02	1.796	B	M	4	16	Z18XE		81751
	85	10/95 → 09/00	1.799	B	M	4	16	X18XE		81550
2.0 DI 16V	60	11/96 → 04/02	1.995	D	M	4	16	X20DTL		81747
2.0 DTI 16V	74	06/97 → 04/02	1.995	D	M	4	16	X20DTH, Y20DTH		81747
2.0 i	82	10/95 → 04/02	1.998	B	M	4	8	Z0NEJ		81551
2.0 i 16V	100	10/95 → 09/00	1.998	B	M	4	16	C20SEL, X20XEV		81550
2.2 DTI 16V	88	09/00 → 04/02	2.172	D	M	4	16	Y22DTR		81747
	92	09/00 → 04/02	2.172	D	M	4	16	Y22DTR		81747
2.2 i 16V	108	09/00 → 04/02	2.198	B	M	4	16	C22SEL, Z22SE		81812
2.5	144	10/99 → 06/00	2.498	B	M	6	24	X25XE		81846
2.5 i V6	125	10/95 → 09/00	2.498	B	M	6	24	X25XE		81846
2.6 i V6	125	09/00 → 04/02	2.597	B	M	6	24	Y26SE		81846
i 500 2.5	143	05/98 → 09/00	2.498	B	M	6	24	X25XE		81846

**Vectra C, Station Wagon**

1.6	74	08/05 →	1.598	B	M	4	16	Z16XE		81817
	77	01/06 →	1.598	B	M	4	16	Z16XEP		82083
1.6 16V	74	06/04 →	1.598	B	M	4	16	Z16XE		81817
1.8	81	04/02 →	1.796	B	M	4	16	Z18XEL		81751
	90	10/03 →	1.796	B	M	4	16	Z18XE		81751
	103	01/06 →	1.796	B	M	4	16	Z18XER		82083
1.8 16V	81	08/02 → 12/06	1.796	B	M	4	16	Z18XEL		81751
	90	04/02 →	1.796	B	M	4	16	Z18XE		81751
1.9 CDTI	74	10/05 →	1.910	D	M	4	8	Z19DT		81352
	74	10/05 →	1.910	D	M	4	8	Z19DTL		81352
	88	04/04 →	1.910	D	M	4	8	Z19DT		81352
	110	04/04 →	1.910	D	M	4	16	Z19DTH		81872
2.0 16V Turbo	129	03/03 →	1.998	B	M	4	16	Z20NET		81812
2.0 DTI	74	10/03 →	1.995	D	M	4	16	Y20DTH		81747
2.0 DTI 16V	74	04/02 →	1.995	D	M	4	16	Y20DTH		81747

**KW**

**cm<sup>3</sup>**

**NO. OF VALVES**

**OPEL**
**Vectra C, Station Wagon**

2.0 Turbo	129	10/03 →	1.998	B	M	4	16	Z20NET		81812
2.2 16V	108	04/02 →	2.198	B	M	4	16	Z22SE		81812
2.2 direct	114	10/03 →	2.198	B	M	4	16	Z22YH		81812
2.2 DTI	92	10/03 →	2.172	D	M	4	16	Y22DTR		81747
2.2 DTI 16V	86	04/02 → 12/04	2.172	D	M	4	16	Y22DTR		81747
	92	04/02 →	2.172	D	M	4	16	Y22DTR		81747
2.8 V6 Turbo	169	08/05 →	2.792	B	M	6	24	Z28NEL		84057 <b>NEW</b>
	184	08/06 →	2.792	B	M	6	24	Z28NET		84057 <b>NEW</b>
	188	08/05 →	2.792	B	M	6	24	Z28NET		84057 <b>NEW</b>
	206	08/06 →	2.792	B	M	6	24	Z28NET		84057 <b>NEW</b>
3.2 V6	155	08/02 →	3.175	B	M	6	24	Z32SE		81846

**Vivaro**

1.9 DI	60	08/01 →	1.870	D	M	4	8	F9Q762		81814
	60	08/01 →	1.870	D	M	4	8	F9Q762		84009
	60	08/01 →	1.870	D	M	4	8	F9Q762, F9Q774		81814
	60	08/01 →	1.870	D	M	4	8	F9Q762, F9Q774		84009
1.9 DTI	74	08/01 →	1.870	D	M	4	8	F9Q760		81814
	74	08/01 →	1.870	D	M	4	8	F9Q760		84009
2.0 16V	88	08/01 →	1.998	B	M	4	16	F4R720		81814
	88	08/01 →	1.998	B	M	4	16	F4R720		84009
2.0 CDTI	66	08/06 →	1.995	D	M	4	16	M9R630, M9R780, M9R782, M9R786		82069
	66	08/06 →	1.995	D	M	4	16	M9R780, M9R782, M9R786		82069
	84	08/06 →	1.995	D	M	4	16	M9R630, M9R692, M9R780, M9R784, M9R786, M9R788		82069
	84	08/06 →	1.995	D	M	4	16	M9R630, M9R780		82069
	84	08/06 →	1.995	D	M	4	16	M9R692, M9R780, M9R784, M9R786, M9R788		82069
2.0 ECOTEC	86	08/06 →	1.998	B	M	4	16	F4R820		81814
	86	08/06 →	1.998	B	M	4	16	F4R820		84009
2.5 CDTI	107	08/06 →	2.463	D	M	4	16	G9MB6, G9U630		81855
	107	08/06 →	2.463	D	M	4	16	G9U630		81855
	84	08/06 →	2.464	D	M	4	16	G9U630		81855
2.5 DTI	99	05/03 →	2.463	D	M	4	16	G9U730		81855

		<b>KW</b>		<b>cm<sup>3</sup></b>				<b>NO. OF VALVES</b>		
--	--	-----------	--	-----------------------	--	--	--	----------------------	--	--

**OPEL**
**Zafira A**

1.6 16V	74	04/99 → 06/05	1.598	B	M	4	16	X16XEL, Z16XE	→ 06-2000, → M: 02MV7224, → M: 20U75998, → M: 02MV7224	82005
	74	04/99 → 06/05	1.598	B	M	4	16	X16XEL, Z16XE	07-2000 →, M →: 02MV7225, M →: 20U75999, M →: 02MV7225	81817
1.6 CNG	71	09/01 → 06/05	1.598		M	4	16	Z16YNG		81817
1.8 16V	85	04/99 → 09/00	1.796	B	M	4	16	X18XE1		81751
	92	09/00 → 06/05	1.796	B	M	4	16	Z18XE		81751
2.0 DI	63	07/99 → 06/00	1.995	D	M	4	16	X20DTL		81747
2.0 DI 16V	60	07/99 → 06/05	1.995	D	M	4	16	X20DTL		81747
2.0 DTI 16V	74	09/00 → 06/05	1.995	D	M	4	16	Y20DTH		81747
2.0 OPC	141	09/01 → 06/05	1.998	B	M	4	16	Z20LET		81550
	147	11/02 → 06/05	1.998	B	M	4	16	Z20LER, Z20LET		81550
2.2 16V	108	09/00 → 06/05	2.198	B	M	4	16	Z22SE		81812
2.2 DTI 16V	86	01/02 → 06/05	2.172	D	M	4	16	Y22DTR		81747
	92	01/02 → 06/05	2.172	D	M	4	16	Y22DTR		81747

**Zafira B, Van**

1.6	77	07/05 →	1.598	B	M	4	16	Z16XE1, Z16XEP		82083
	85	01/08 →	1.598	B	M	4	16	A16XER, Z16XER		82083
1.6 CNG	69	01/06 →	1.598		M	4	16	Z16YNG		81817
1.6 CNG Turbo	110	02/09 →	1.598		M	4	16	A16XNT, Z16XNT		81817
	110	02/09 →	1.598		M	4	16	A16XNT, Z16XNT		82083
1.7 CDTI	81	01/08 →	1.686	D	M	4	16	A17DTJ, Z17DTJ	→ T: 1874032	81836
	81	01/08 →	1.686	D	M	4	16	A17DTJ, Z17DTJ	T →: 1874033	84005
	81	01/08 →	1.686	D	M	4	16	A17DTJ, Z17DTJ		81836
	81	01/08 →	1.686	D	M	4	16	A17DTJ, Z17DTJ		84005
	92	01/08 →	1.686	D	M	4	16	A17DTR	→ T: 1874032	81836
	92	01/08 →	1.686	D	M	4	16	A17DTR	T →: 1874033	84005
	92	01/08 →	1.686	D	M	4	16	A17DTR		81836
	92	01/08 →	1.686	D	M	4	16	A17DTR		84005
1.8	88	06/13 →	1.796	B	M	4	16	A18XEL		82083
	103	07/05 →	1.796	B	M	4	16	A18XER, Z18XER		82083
1.9 CDTI	74	07/05 →	1.910	D	M	4	8	Z19DTL		81352
	88	07/05 →	1.910	D	M	4	8	Z19DT		81352
	110	07/05 →	1.910	D	M	4	16	Z19DTH		81872
2.0	147	07/05 →	1.998	B	M	4	16	Z20LER		81550
	177	01/06 →	1.998	B	M	4	16	Z20LEH		81550
2.2	110	07/05 →	2.198	B	M	4	16	Z22YH		81812

**KW**

**cm<sup>3</sup>**

**NO. OF VALVES**

**MAGNETI MARELLI**
**OPEL**
**Zafira C**

1.4 <	88	10/11 →	1.364	B	M	4	16	A14NEL, B14NEL		84027	<b>NEW</b>
	103	10/11 →	1.364	B	M	4	16	A14NET, B14NET		84027	<b>NEW</b>
1.4 LPG	103	10/11 →	1.364		M	4	16	A14NET, B14NET		84027	<b>NEW</b>
1.6 CNG	110	10/11 →	1.598		M	4	16	A16XNT, B16XNT		82083	
1.8	85	10/11 →	1.796	B	M	4	16	A18XEL		82083	
	88	10/11 →	1.796	B	M	4	16	A18XEL		82083	
	103	10/11 →	1.796	B	M	4	16	A18XER		82083	
1.8 LPG	101	10/11 →	1.796		M	4	16	A18XER		82083	
2.0 BiTurbo CDTI	143	01/13 →	1.956	D	M	4	16	A20DTR		81872	
2.0 CDTi	81	10/11 →	1.956	D	M	4	16	A20DTL		81872	
	96	10/11 →	1.956	D	M	4	16	A20DT, Y20DTJ, Z20DTJ		81872	
	118	10/11 →	1.956	D	M	4	16	A20DTH		81872	
	121	10/11 →	1.956	D	M	4	16	A20DTH		81872	

**PEUGEOT**
**106 I, Van**

1.0	33	09/91 → 03/01	954	B	M	4	8	CDY (TU9M), TU9		81797	
	33	09/91 → 04/96	954	B	M	4	8	CDY (TU9M), TU9		81556	
	37	09/91 → 04/96	954	B	M	4	8	CDZ (TU9M)		81556	
1.1	44	09/91 → 04/96	1.124	B	M	4	8	HDZ (TU1M)		81556	
1.3	72	10/93 → 04/96	1.294	B	M	4	8	TU2J2		81556	
1.4	51	08/91 → 03/96	1.360	B	M	4	8	K5A (TU3)		81556	
	55	09/91 → 04/96	1.361	B	M	4	8	KDX (TU3MC), KDY (TU3M)		81556	
	69	09/91 → 04/96	1.361	B	M	4	8	KFZ (TU3J2/Z)		81556	
1.4 D	37	09/92 → 04/96	1.361	D	M	4	8	K9Y (TUD3Y)		81556	
1.5 D	40	06/94 → 04/96	1.527	D	M	4	8	VJY (TUD5)		81513	
	42	10/00 → 03/01	1.527	D	M	4	8	VJX (TUD5)		81513	
	43	06/94 → 04/96	1.527	D	M	4	8	VJY (TUD5)		81513	
1.6	65	06/93 → 04/96	1.587	B	M	4	8	NFZ (TU5JP)		81556	
	76	01/94 → 04/96	1.587	B	M	4	8	NFY (TU5J2)		81513	

**106 II**

1.0 i	33	05/96 →	954	B	M	4	8	CDY (TU9M)		81556	
	37	01/97 →	954	B	M	4	8	CDZ (TU9M)		81556	
1.1 i	40	01/97 →	1.124	B	M	4	8	HDY (TU1M)		81556	
	44	05/96 →	1.124	B	M	4	8	HDZ (TU1M), HFX (TU1JP)		81556	
1.4 i	55	05/96 →	1.360	B	M	4	8	KFW (TU3JP), KFX (TU3JP)		81556	
1.5 D	40	05/96 →	1.527	D	M	4	8	VJY (TUD5)	04-1996 →	81513	
	42	04/98 →	1.527	D	M	4	8	VJX (TUD5)		81513	



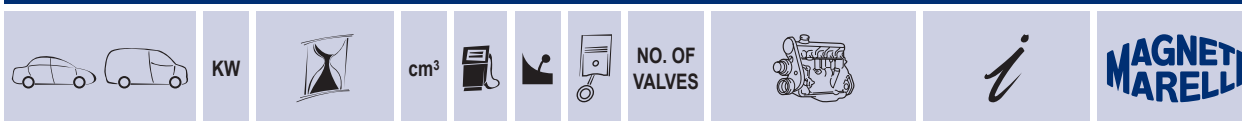

## PEUGEOT

### 106 II

1.6 i	65	05/96 →	1.587	B	M	4	8	NFZ (TU5JP)		81556
	74	05/96 →	1.587	B	M	4	8	NFW (TU5J2), NFY (TU5J2)		81513
1.6 S16	87	05/96 →	1.587	B	M	4	16	NFX (TU5J4)		81753

### 107

1.0	50	06/05 →	998	B	M	3	12	1KR (384F), CFA (384F)		82063
1.4 HDi	40	06/05 →	1.398	D	M	4	8	8HT (DV4TD)		81798

### 108

1.0 VTi	51	05/14 →	998	B	M	3	12	1KR-FE		84054 <b>NEW</b>
1.2	60	05/14 →	1.199	B	M	3	12	HMT (EB2D)		84066 <b>NEW</b>

### 205 I, Van, Cabrio

1.1 CJ	44	10/89 → 12/94	1.124	B	M	4	8	HDZ (TU1M)		81556
1.4	62	08/87 → 06/94	1.360	B	M	4	8	K2B (TU3S)		81572
1.4 CJ	49	03/89 → 12/94	1.360	B	M	4	8	K1D (TU3A)		81556
	55	05/91 → 12/94	1.361	B	M	4	8	KDY (TU3M), KDZ (TU3M)		81556
1.4 CJ Cat.	44	01/89 → 09/93	1.361	B	M	4	8	KAY (TU3CP)		81572
1.6	85	08/87 → 07/92	1.580	B	M	4	8	B6D (XU5JA)		81554
1.6 CJ	65	08/92 → 12/94	1.580	B	M	4	8	BDY (XU5M3Z)		81512
1.6 CTI	76	04/86 → 10/90	1.580	B	M	4	8	180A (XU5J), 180Z (XU5J)		81554
1.9 CTI	75	10/87 → 12/94	1.905	B	M	4	8	DFZ (XU9J1)	→ 12-1991	81554
	75	10/87 → 12/94	1.905	B	M	4	8	DFZ (XU9J1)	01-1992 →	81512
	92	08/90 → 07/92	1.905	B	M	4	8	DKZ (XU9JAZ)		81554

### 205 II, Van

1.0	33	10/87 → 09/98	954	B	M	4	8	TU9		81556
	37	08/92 → 05/97	954	B	M	4	8	CDZ (TU9M)		81556
1.1	36	10/87 → 10/90	1.124	B	M	4	8	109N (XW7)		81572
	40	10/87 → 10/90	1.124	B	M	4	8	H1B (TU1)		81556
	40	08/98 → 07/00	1.124	B	M	4	8	HFY (TU1JP)	→ M: 3.762.433	81556
	40	08/98 → 07/00	1.124	B	M	4	8	HFY (TU1JP)	M →: 3.762.434	81797
	44	07/89 → 09/98	1.124	B	M	4	8	HDZ (TU1M)		81556
	44	09/98 →	1.124	B	M	4	8	HFX (TU1JP), HFZ (TU1JP)	→ M: 3.762.433	81556
1.1 i	44	09/98 →	1.124	B	M	4	8	HFX (TU1JP), HFZ (TU1JP)	M →: 3.762.434	81797
	47	01/87 → 12/90	1.204	B	M	4	8	F1		81560
1.3	47	08/90 → 07/92	1.294	B	M	4	8	G1A		81560
1.3 Rallye	74	10/87 → 10/90	1.294	B	M	4	8	TU24		81556
1.4	49	10/87 → 10/90	1.360	B	M	4	8	K1D (TU3A)		81556
	55	07/88 → 09/98	1.361	B	M	4	8	KDY (TU3M), KDZ (TU3M), KFX (TU3JP)		81556
1.4 16V	65	10/03 →	1.360	B	M	4	16	KFU (ET3J4)		82016

**KW**

**cm<sup>3</sup>**

**NO. OF VALVES**

**MAGNETI MARELLI**
**PEUGEOT**
**205 II, Van**

1.4 Cat.	44	08/87 → 09/93	1.360	B	M	4	8	KAY (TU3CP)		81556
1.4 HDi	51	09/02 → 02/07	1.398	D	M	4	8	8HX (DV4TD)		81798
1.4 HDi eco 70	50	09/01 →	1.398	D	M	4	8	8HX (DV4TD), 8HZ (DV4TD)		81798
1.4 i	55	09/98 →	1.360	B	M	4	8	KFW (TU3JP), KFX (TU3JP)	→ M: 3.666.765	81556
	55	09/98 →	1.360	B	M	4	8	KFW (TU3JP), KFX (TU3JP)	M →: 3.666.766	81797
1.4 LPG	55	05/06 → 09/07	1.360		M	4	8	KFV (TU3JP)		81797
	55	05/06 → 09/07	1.360		M	4	8	KFV (TU3JP)		81556
1.6	53	10/87 → 09/98	1.580	B	M	4	8	B1E (XU51C)		81554
	55	10/87 → 09/98	1.580	B	M	4	8	B1A (XU51C), BAZ (XU5CP)		81554
1.6 16V	80	12/00 →	1.587	B	AM	4	16	NFU (TU5JP4)		81753
1.6 Aut.	58	10/87 → 09/98	1.580	B	M	4	8		→ 12-1991	81554
	58	10/87 → 09/98	1.580	B	M	4	8		01-1992 →	81512
	65	05/90 → 09/98	1.580	B	M	4	8	BDY (XU5M2Z), BDY (XU5M3Z)		81512
1.6 GTX	69	01/87 → 10/91	1.592	B	M	4	8			81560
1.6 HDi 110	80	05/04 →	1.560	D	M	4	16	9HY (DV6TED4), 9HZ (DV6TED4)		81869
1.6 i	65	09/98 → 12/00	1.587	B	M	4	8	NFZ (TU5JP)		81513
1.7 Diesel	44	07/87 → 09/98	1.769	D	M	4	8	161A (XUD7)		81672
	44	03/94 →	1.769	D	M	4	8	161A (XUD7)		81642
1.8 TD	57	01/90 → 09/98	1.769	D	M	4	8	A8B (XUD7TE)		81672
1.9 D	51	09/98 → 11/01	1.868	D	M	4	8	WJY (DW8B), WJZ (DW8)		81713
1.9 Diesel	47	10/87 → 09/98	1.905	D	M	4	8	DJZ (XUD9Y)		81672
1.9 GTI	88	10/87 → 10/94	1.905	B	M	4	8	DKZ (XU9JAZ)	→ 12-1991	81554
	88	10/87 → 10/94	1.905	B	M	4	8	DKZ (XU9JAZ)	01-1992 →	81512
	94	10/87 → 09/98	1.905	B	M	4	8	D6B (XU9JA)	→ 12-1991	81554
	94	10/87 → 09/98	1.905	B	M	4	8	D6B (XU9JA)	01-1992 →	81512
1.9 GTI Cat.	75	10/87 → 07/94	1.905	B	M	4	8	DFZ (XU9J1)	→ 12-1991	81554
	75	10/87 → 07/94	1.905	B	M	4	8	DFZ (XU9J1)	01-1992 →	81512
2.0 HDi 90	66	12/99 →	1.997	D	M	4	8	RHY (DW10TD)		81713
2.0 RC	130	07/03 →	1.997	B	M	4	16	RFK (EW10J4S)	(-)COP	84038 <b>NEW</b>
	130	07/03 →	1.997	B	M	4	16	RFK (EW10J4S)	(+)COP	82089
	130	07/03 →	1.997	B	M	4	16	RFK (EW10J4S)		82089
	130	07/03 →	1.997	B	M	4	16	RFK (EW10J4S)		81799

	KW		cm <sup>3</sup>				NO. OF VALVES		
--	----	--	-----------------	--	--	--	---------------	--	--

## PEUGEOT

### 205 II, Van

2.0 S16	99	04/99 → 10/00	1.997	B	M	4	16	RFR (DEW10J4)	(-)COP	84038	<b>NEW</b>
	99	04/99 → 10/00	1.997	B	M	4	16	RFR (DEW10J4)	(+)COP	82089	
	99	04/99 → 10/00	1.997	B	M	4	16	RFR (DEW10J4)		82089	
	99	04/99 → 10/00	1.997	B	M	4	16	RFR (DEW10J4)		81799	
	100	06/99 →	1.997	B	M	4	16	RFN (EW10J4)	(-)COP	84038	<b>NEW</b>
	100	06/99 →	1.997	B	M	4	16	RFN (EW10J4)	(+)COP	82089	
	100	06/99 →	1.997	B	M	4	16	RFN (EW10J4)		82089	
	100	06/99 →	1.997	B	M	4	16	RFN (EW10J4)		81799	

### 206 +

1.1	44	01/09 →	1.124	B	M	4	8	HFX (TU1A), HFX (TU1JP), TU1AE5		81797	
1.4 HDi eco 70	50	01/09 →	1.398	D	M	4	8	8HX (DV4TD), 8HZ (DV4TD)		81798	
1.4 i	54	09/10 →	1.360	B	M	4	8	KFT (TU3A)		81797	
	55	01/09 →	1.360	B	M	4	8	KFV (TU3A), KFW (TU3A)		81797	

### 206, CC, Van

1.1	44	07/02 →	1.124	B	M	4	8	HFX (TU1JP)	→ M: 3.762.433	81556	
	44	07/02 →	1.124	B	M	4	8	HFX (TU1JP)	M →: 3.762.434	81797	
1.4	55	07/02 →	1.360	B	M	4	8	KFV (TU3A), KFW (TU3JP)	→ M: 3.666.765	81556	
	55	07/02 →	1.360	B	M	4	8	KFV (TU3A), KFW (TU3JP)	M →: 3.666.766	81797	
	55	03/07 →	1.360	B	M	4	8	KFV (TU3A), KFW (TU3JP)		81797	
1.4 16V	65	10/03 →	1.360	B	M	4	16	KFU (ET3J4)		82016	
1.4 HDi	50	07/02 →	1.398	D	M	4	8	8HX (DV4TD)		81798	
	50	09/01 → 03/09	1.398	D	M	4	8	8HX (DV4TD), 8HZ (DV4TD)		81798	
1.4 HDi eco 70	50	09/08 →	1.398	D	M	4	8	8HZ (DV4TD)		81798	
1.6 16V	80	07/02 →	1.587	B	M	4	16	NFU (TU5JP4)		81753	
	80	09/00 →	1.587	B	AM	4	16	NFU (TU5JP4)		81753	
1.6 HDi 110	80	04/05 →	1.560	D	M	4	16	9HZ (DV6TED4)		81869	
1.9 D	51	04/99 → 05/07	1.868	D	M	4	8	WJZ (DW8)		81713	
2.0 16V	100	07/02 →	1.997	B	M	4	16	RFN (EW10J4)	(-)COP	84038	<b>NEW</b>
	100	07/02 →	1.997	B	M	4	16	RFN (EW10J4)	(+)COP	82089	
	100	07/02 →	1.997	B	M	4	16	RFN (EW10J4)		82089	
	100	07/02 →	1.997	B	M	4	16	RFN (EW10J4)		81799	
2.0 HDi	66	07/02 →	1.997	D	M	4	8	RHY (DW10TD)		81713	
2.0 S16	100	09/00 →	1.997	B	M	4	16	RFN (EW10J4)	(-)COP	84038	<b>NEW</b>
	100	09/00 →	1.997	B	M	4	16	RFN (EW10J4)	(+)COP	82089	
	100	09/00 →	1.997	B	M	4	16	RFN (EW10J4)		82089	
	100	09/00 →	1.997	B	M	4	16	RFN (EW10J4)		81799	

**KW**

**cm<sup>3</sup>**

**NO. OF VALVES**

**MAGNETI MARELLI**
**PEUGEOT**
**207, Station Wagon, CC, Van**

1.4	53	02/06 →	1.360	B	M	4	8	KFV (TU3A)	81797
	54	12/07 →	1.360	B	M	4	8	KFT (TU3A), KFV (TU3A)	81797
	54	12/07 →	1.360	B	M	4	8	KFV (TU3A)	81797
	55	08/08 →	1.360	B	M	4	8	KFV (TU3A), KFW (TU3A)	81797
1.4 16V	65	02/06 →	1.360	B	M	4	16	KFU (ET3J4)	82016
	70	06/07 →	1.397	B	M	4	16	8FS (EP3), EP3, EP3C	82032
	70	06/07 →	1.397	B	M	4	16	8FS (EP3), EP3, EP3C	82016
	72	10/09 →	1.397	B	M	4	16	8FR (EP3)	82032
1.4 Bioflex	60	08/08 →	1.360		M	4	8	KFW (TU3JP)	81797
1.4 Flex	60	11/08 →	1.360		M	4	8	KFW (TU3A)	81797
1.4 HDi	50	02/06 →	1.398	D	M	4	8	8HR (DV4C), 8HZ (DV4TD)	81798
	50	04/07 →	1.398	D	M	4	8	8HZ (DV4TD)	81798
1.6	81	08/08 →	1.587	B	M	4	16	N6A (TU5JP4)	81753
1.6 16V	80	02/06 →	1.587	B	M	4	16	NFU (TU5JP4)	81753
	88	02/07 →	1.598	B	M	4	16	5FS (EP6C), 5FW (EP6), EP6	82032
1.6 16V RC	128	02/07 →	1.598	B	M	4	16	5FY (EP6DTS)	82032
1.6 16V Turbo	110	02/06 →	1.598	B	M	4	16	5FX (EP6DT)	82032
	115	10/09 →	1.598	B	M	4	16	5FR (EP6DT)	82032
	115	10/09 →	1.598	B	M	4	16	5FR (EP6DT), EP6CDT	82032
1.6 16V VTi	88	02/07 →	1.598	B	M	4	16	5FS (EP6C), 5FW (EP6), EP6	82032
1.6 Bioflex	83	01/08 →	1.587		M	4	16	N6A (TU5JP4)	81753
1.6 HDi	66	02/06 →	1.560	D	M	4	16	9HV (DV6TED4), 9HX (DV6ATED4)	81869
	66	06/07 →	1.560	D	M	4	16	9HX (DV6ATED4)	81869
	68	11/09 →	1.560	D	M	4	8	9HP (DV6DTED)	81869
	80	02/06 →	1.560	D	M	4	16	9HY (DV6TED4), 9HZ (DV6TED4)	81869
	80	02/07 →	1.560	D	M	4	16	9HZ (DV6TED4)	81869
	82	08/09 →	1.560	D	M	4	8	9HR (DV6C)	81869
1.6 HDi 110	82	08/09 →	1.560	D	M	4	8	9HR (DV6C)	81869
<b>208</b>									
1.0	50	03/12 →	999	B	M	3	12	ZMZ (EB0)	84066
1.2	60	03/12 →	1.199	B	M	3	12	HMZ (EB2F)	84066
1.2 THP	81	01/13 →	1.199	B	M	3	12	HNZ (EB2DT)	84066
1.4 GPL	70	10/13 →	1.397		M	4	16	EP3C	82032
1.4 HDi	50	03/12 →	1.398	D	M	4	8	8HP (DV4C), 8HR (DV4C)	81798
1.4 VTi	70	03/12 →	1.397	B	M	4	16	8FS (EP3), EP3C	82032

	KW		cm <sup>3</sup>				NO. OF VALVES			
--	----	--	-----------------	--	--	--	---------------	--	--	--

## PEUGEOT

### 208

1.6	88	03/12 →	1.598	B	M	4	16	5FS (EP6C)		82032
	115	03/12 →	1.598	B	M	4	16	5FV (EP6DT), EP6CDT		82032
1.6 BlueHdI 100	73	01/15 →	1.560	D	M	4	8	BHY (DV6FD)		81869
1.6 BlueHdI 120	88	11/13 →	1.560	D	M	4	8	BHZ (DV6FC)		81869
1.6 GTi	147	08/12 →	1.598	B	M	4	16	5FU (EP6CDTX)		82032
	153	10/14 →	1.598	B	M	4	16			82032
1.6 HdI	68	03/12 →	1.560	D	M	4	8	9HP (DV6DTED)		81869
	84	03/12 →	1.560	D	M	4	8	9HD (DV6CTED)		81869
	85	04/14 →	1.560	D	M	4	8	BHX (DV6FC)		81869
1.6 HdI / BlueHdI 75	55	01/13 →	1.560	D	M	4	8	9HK (DV6ETEDM), BHW (DV6FE)		81869
1.6 THP 165	121	03/15 →	1.598	B	M	4	16			82032

### 301

1.2 VTi 72	53	11/12 →	1.199	B	M	3	12	HMY (EB2M)		84066 <b>NEW</b>
1.6 HdI 90	68	11/12 →	1.560	D	M	4	8	9HF (DV6DTED)		81869
1.6 VTi 115	85	11/12 →	1.587	B	M	4	16	NFP (EC5)		81753

### 305 II, Station Wagon

1.5	50	09/85 → 07/90	1.472	B	M	4	8	142 (XR5A)	VA, BC	81552
	50	09/85 → 07/90	1.472	B	M	4	8	142 (XR5A)	VF, BC	81671

### 306, Station Wagon, Coupé, Cabrio, Van

1.1	44	06/94 → 05/01	1.124	B	M	4	8	HDZ (TU1M)		81556
1.4	55	05/93 → 05/01	1.360	B	M	4	8	KDX (TU3MC), KFW (TU3JP), KFX (TU3JP)	→ M: 3.666.765	81556
	55	05/93 → 05/01	1.360	B	M	4	8	KDX (TU3MC), KFW (TU3JP), KFX (TU3JP)	M →: 3.666.766	81797
	55	03/97 → 04/02	1.360	B	M	4	8	KFW (TU3JP), KFX (TU3JP)	→ M: 3.666.765	81556
	55	03/97 → 04/02	1.360	B	M	4	8	KFW (TU3JP), KFX (TU3JP)	M →: 3.666.766	81797
1.4 SL	55	06/94 → 05/01	1.360	B	M	4	8	KDX (TU3MC), KFW (TU3JP), KFX (TU3JP)	→ M: 3.666.765	81556
	55	06/94 → 05/01	1.360	B	M	4	8	KDX (TU3MC), KFW (TU3JP), KFX (TU3JP)	M →: 3.666.766	81797
1.6	65	05/93 → 10/00	1.587	B	M	4	8	NFZ (TU5JP)		81513
	72	10/00 → 05/01	1.587	B	M	4	8	NFT (TU5JP)		81513
1.6 SR	65	06/94 → 10/00	1.587	B	M	4	8	NFZ (TU5JP)		81513
1.8	74	05/93 → 05/01	1.762	B	M	4	8	LFZ (XU7JP)		81512
1.8 16V	81	03/97 → 05/01	1.761	B	M	4	16	LFY (XU7JP4)		81710
1.8 D	43	05/93 → 05/01	1.769	D	M	4	8	A9A (XUD7)	→ PROD: 7390	81672
	43	05/93 → 05/01	1.769	D	M	4	8	A9A (XUD7)	PROD →: 7391	81642

**KW**

**cm<sup>3</sup>**

**NO. OF VALVES**

**PEUGEOT**
**306, Station Wagon, Coupé, Cabrio, Van**

1.8 ST	74	06/94 → 05/01	1.762	B	M	4	8	LFZ (XU7JP)		81512
1.9 D	51	09/98 → 05/01	1.868	D	M	4	8	WJY (DW8B), WJZ (DW8)		81713
	47	05/93 → 05/01	1.905	D	M	4	8	DJZ (XUD9Y)	→ PROD: 7390	81672
	47	05/93 → 05/01	1.905	D	M	4	8	DJZ (XUD9Y)	PROD →: 7391	81642
	50	06/94 → 05/01	1.905	D	M	4	8	DJY (XUD9A)	→ PROD: 7390	81672
	50	06/94 → 05/01	1.905	D	M	4	8	DJY (XUD9A)	PROD →: 7391	81642
	55	03/98 → 05/01	1.905	D	M	4	8	DHV (XUD9BSD)	→ PROD: 7390	81672
	55	03/98 → 05/01	1.905	D	M	4	8	DHV (XUD9BSD)	PROD →: 7391	81642
1.9 DT	66	05/93 → 05/01	1.905	D	M	4	8	DHY (XUD9TE)	→ PROD: 7390	81672
	66	05/93 → 05/01	1.905	D	M	4	8	DHY (XUD9TE)	PROD →: 7391	81642
1.9 SLD	47	06/94 → 05/01	1.905	D	M	4	8	DJZ (XUD9Y)	→ PROD: 7390	81672
	47	06/94 → 05/01	1.905	D	M	4	8	DJZ (XUD9Y)	PROD →: 7391	81642
	50	06/94 → 05/01	1.905	D	M	4	8	DJY (XUD9A)	→ PROD: 7390	81672
	50	06/94 → 05/01	1.905	D	M	4	8	DJY (XUD9A)	PROD →: 7391	81642
1.9 SRDT	66	06/94 → 05/01	1.905	D	M	4	8	DHY (XUD9TE)	→ PROD: 7390	81672
	66	06/94 → 05/01	1.905	D	M	4	8	DHY (XUD9TE)	PROD →: 7391	81642
1.9 TD	66	02/97 → 04/02	1.905	D	M	4	8	DHY (XUD9TE)	→ PROD: 7390	81672
	66	02/97 → 04/02	1.905	D	M	4	8	DHY (XUD9TE)	PROD →: 7391	81642
2.0	89	03/94 → 04/02	1.998	B	M	4	8	RFX (XU10J2)		81642
	97	03/97 → 05/01	1.998	B	M	4	16	RFV (XU10J4R)		81711
2.0 16V	97	03/97 → 05/01	1.998	B	M	4	16	RFV (XU10J4R)		81711
	99	03/97 → 06/00	1.998	B	M	4	16	RFV (XU10J4R)		81711
2.0 HDI 90	66	06/99 → 05/01	1.997	D	M	4	8	RHY (DW10TD)		81713
2.0 S16	110	06/94 → 05/01	1.998	B	M	4	16	RFT (XU10J4)		81642
	112	06/94 → 05/01	1.998	B	M	4	16	RFY (XU10J4Z)		81642
	120	03/96 → 05/01	1.998	B	M	4	16	RFS (XU10J4RS)		81711
2.0 ST	89	07/94 → 05/01	1.998	B	M	4	8	RFX (XU10J2)		81642
2.0 XSi	89	05/93 → 05/01	1.998	B	M	4	8	RFX (XU10J2)		81642

**307, Station Wagon, CC**

1.4	55	08/00 →	1.360	B	M	4	8	KFW (TU3JP)	→ M: 3.666.765	81556
	55	08/00 →	1.360	B	M	4	8	KFW (TU3JP)	M →: 3.666.766	81797
1.4 16V	65	11/03 →	1.360	B	M	4	16	KFU (ET3J4)		82016
1.4 HDi	50	10/01 →	1.398	D	M	4	8	8HX (DV4TD), 8HZ (DV4TD)		81798
	50	03/02 →	1.398	D	M	4	8	8HZ (DV4TD)		81798
1.6	81	07/06 →	1.587	B	M	4	16	NFU (TU5JP4)		81753
1.6 16V	80	08/00 →	1.587	B	M	4	16	NFU (TU5JP4)		81753
1.6 BioFlex	80	09/07 →	1.587		M	4	16	NFU (TU5JP4)		81753
1.6 HDi	66	04/05 →	1.560	D	M	4	16	9HV (DV6ATED4)		81869
	66	04/05 →	1.560	D	M	4	16	9HV (DV6ATED4), 9HV (DV6TED4), 9HX (DV6ATED4)		81869

--	--	--	--	--	--	--	--	--	--

## PEUGEOT

### 307, Station Wagon, CC

1.6 HDi 110	80	02/04 →	1.560	D	M	4	16	9HY (DV6TED4), 9HZ (DV6TED4)		81869
1.6 HDi 90	66	12/06 →	1.560	D	M	4	16	9HV (DV6ATED4), 9HX (DV6ATED4)		81869
2.0	100	03/02 →	1.997	B	M	4	16	RFN (EW10J4)	(-)COP	84038 <b>NEW</b>
	100	03/02 →	1.997	B	M	4	16	RFN (EW10J4)	(+)COP	82089
	100	03/02 →	1.997	B	M	4	16	RFN (EW10J4)		82089
	100	03/02 →	1.997	B	M	4	16	RFN (EW10J4)		81799
	105	08/08 →	1.997	B	M	4	16	RFN (EW10J4)	(-)COP	84038 <b>NEW</b>
	105	08/08 →	1.997	B	M	4	16	RFN (EW10J4)	(+)COP	82089
	105	08/08 →	1.997	B	M	4	16	RFN (EW10J4)		82089
	105	08/08 →	1.997	B	M	4	16	RFN (EW10J4)		81799
2.0 16V	100	08/00 →	1.997	B	M	4	16	RFN (EW10J4)	(-)COP	84038 <b>NEW</b>
	100	08/00 →	1.997	B	M	4	16	RFN (EW10J4)	(+)COP	82089
	100	08/00 →	1.997	B	M	4	16	RFN (EW10J4)		82089
	100	08/00 →	1.997	B	M	4	16	RFN (EW10J4)		81799
	103	03/05 →	1.997	B	M	4	16	RFJ (EW10A)	(-)COP	84038 <b>NEW</b>
	103	03/05 →	1.997	B	M	4	16	RFJ (EW10A)	(+)COP	82089
	103	03/05 →	1.997	B	M	4	16	RFJ (EW10A)	M: EW10J4	81799
	103	03/05 →	1.997	B	M	4	16	RFJ (EW10A)		82089
	103	03/05 →	1.997	B	M	4	16	RFJ (EW10A)		81799
	103	03/05 →	1.997	B	M	4	16	RFJ (EW10A), RFN (EW10J4)	(-)COP	84038 <b>NEW</b>
	103	03/05 →	1.997	B	M	4	16	RFJ (EW10A), RFN (EW10J4)	(+)COP	82089
	103	03/05 →	1.997	B	M	4	16	RFJ (EW10A), RFN (EW10J4)		82089
	103	03/05 →	1.997	B	M	4	16	RFJ (EW10A), RFN (EW10J4)		81799
2.0 16V	130	06/05 →	1.997	B	M	4	16	RFK (EW10J4S)	(-)COP	84038 <b>NEW</b>
	130	06/05 →	1.997	B	M	4	16	RFK (EW10J4S)	(+)COP	82089
	130	06/05 →	1.997	B	M	4	16	RFK (EW10J4S)		82089
2.0 16V	130	06/05 →	1.997	B	M	4	16	RFK (EW10J4S)		81799
2.0 HDi 110	79	08/00 →	1.997	D	M	4	8	RHS (DW10ATED)		81713
2.0 HDi 135	100	10/03 →	1.997	D	M	4	16	RHR (DW10BTED4)		81800
2.0 HDi 90	66	08/00 →	1.997	D	M	4	8	RHY (DW10TD)		81713
<b>308 I, Station Wagon, CC</b>										
1.4 16V	70	09/07 →	1.397	B	M	4	16	8FS (EP3)		82032
	70	09/07 →	1.397	B	M	4	16	8FS (EP3), EP3		82032
	72	12/09 →	1.397	B	M	4	16	8FR (EP3)		82032
1.6	120	01/12 →	1.598	B	M	4	16	5FV (EP6DT)		82032

**KW**

**cm<sup>3</sup>**

**NO. OF VALVES**

**MAGNETI MARELLI**
**PEUGEOT**
**308 I, Station Wagon, CC**

1.6 16V	88	09/07 →	1.598	B	M	4	16	5FW (EP6), EP6		82032
	88	06/09 →	1.598	B	M	4	16	EP6		82032
	103	09/07 →	1.598	B	M	4	16	5FT (EP6DT)		82032
	110	09/07 →	1.598	B	M	4	16	5FX (EP6DT)		82032
	115	10/09 →	1.598	B	M	4	16	EP6CDT		82032
	128	03/08 →	1.598	B	M	4	16	5FY (EP6DTS)		82032
1.6 Bioflex	80	04/08 →	1.587		M	4	16	NFU (TU5JP4)		81753
	82	03/09 →	1.587		M	4	16	NFU (TU5JP4)		82032
1.6 GTi	147	07/10 →	1.598	B	M	4	16	EP6CDTX		82032
1.6 HDi	66	09/07 →	1.560	D	M	4	16	9HV (DV6ATED4), 9HX (DV6ATED4)		81869
	66	09/07 →	1.560	D	M	4	8			81869
	68	11/09 →	1.560	D	M	4	8	9HP (DV6DTE)		81869
	80	09/07 →	1.560	D	M	4	16	9HZ (DV6TED4)		81869
	82	12/09 →	1.560	D	M	4	8	9HR (DV6C)		81869
	84	03/13 →	1.560	D	M	4	16			81869
1.6 THP	147	10/10 →	1.598	B	M	4	16	EP6CDTX		82032
2.0 Bioflex	103	01/08 → 01/12	1.997		M	4	16	RFJ (EW10A)	(-)COP	84038 <b>NEW</b>
	103	01/08 → 01/12	1.997		M	4	16	RFJ (EW10A)	(+)COP	82089
	103	01/08 →	1.997		M	4	16	RFJ (EW10A)		82089
2.0 CVVT	103	07/09 → 11/14	1.997	B	M	4	16	RFJ (EW10A)	(-)COP	84038 <b>NEW</b>
	103	07/09 → 11/14	1.997	B	M	4	16	RFJ (EW10A)	(+)COP	82089
2.0 HDi	100	09/07 →	1.997	D	M	4	16	RHR (DW10BTED4)		81800
	103	04/09 →	1.997	D	M	4	16	RHF (DW10BTED4)		81800
	103	07/10 →	1.997	D	M	4	16	RHR (DW10BTED4)		81800
	110	10/11 →	1.997	D	M	4	16	RHE (DW10CTED4)		84020 <b>NEW</b>
	120	04/12 →	1.997	D	M	4	16	RHH (DW10CTED4)		84020 <b>NEW</b>

**308 II Station Wagon**

1.2 THP 110	81	11/13 →	1.199	B	M	3	12	HNZ (EB2DT)		84066 <b>NEW</b>
1.2 THP 130	96	11/13 →	1.199	B	M	3	12	HNY (EB2DTS)		84066 <b>NEW</b>
1.2 VTi 72	60	09/13 →	1.199	B	M	3	12	HMZ (EB2F)		84066 <b>NEW</b>
1.6	115	09/13 →	1.598	B	M	4	16	5FV (EP6DT)		82032
1.6 BlueHDi 100	73	04/14 →	1.560	D	M	4	8	BHY (DV6FD)		81869
1.6 BlueHDi 120	88	11/13 →	1.560	D	M	4	8	BHZ (DV6FC)		81869
1.6 GT 205	151	06/14 →	1.598	B	M	4	16			82032
1.6 GTi	184	08/15 →	1.598	B	M	4	16			82032
	200	06/15 →	1.598	B	M	4	16	5GN (EP6FDTR)		82032
1.6 HDi	68	09/13 →	1.560	D	M	4	8			81869
1.6 HDi / BlueHDi 115	85	09/13 →	1.560	D	M	4	8	9HC (DV6C), BHZ (DV6FC)		81869
1.6 HDi 100	73	04/14 →	1.560	D	M	4	8	BHY (DV6FD)		81869
1.6 HDi 92	68	03/14 →	1.560	D	M	4	8			81869
1.6 THP 125	92	09/13 →	1.598	B	M	4	16			82032
1.6 THP 155	115	03/14 →	1.598	B	M	4	16	5FV (EP6DT)		82032



**KW**

**cm<sup>3</sup>**

**NO. OF VALVES**

**MAGNETI MARELLI**
**PEUGEOT**
**308 II Station Wagon**

1.6 VTi	85	03/14 →	1.598	B	M	4	16			81753
2.0 BlueHDi 150	110	11/13 →	1.997	D	M	4	16			82068
	110	03/14 →	1.997	D	M	4	8			82068
2.0 GT BlueHDi 180	133	06/14 →	1.997	D	M	4	16			82068
2.0 GT HDi 180	133	06/14 →	1.997	D	M	4	16			82068

**309 II**

1.1	40	09/89 → 10/93	1.124	B	M	4	8	H1B (TU1)		81560
	44	08/90 → 12/93	1.124	B	M	4	8	HDZ (TU1M)		81556
1.4	49	07/90 → 12/93	1.361	B	M	4	8	K1D (TU3A)		81556
	55	07/89 → 12/93	1.361	B	M	4	8	KDY (TU3M), KDZ (TU3M)		81556
1.6	65	07/89 → 12/93	1.580	B	M	4	8	BDY (XU5M2Z), BDY (XU5M3Z), BDZ (XU5M)	→ 01-1992	81554
	65	07/89 → 12/93	1.580	B	M	4	8	BDY (XU5M2Z), BDY (XU5M3Z), BDZ (XU5M)	02-1992 →	81512
	68	07/89 → 12/93	1.580	B	M	4	8	B2A (XU52C/K)	→ 01-1992	81554
	68	07/89 → 12/93	1.580	B	M	4	8	B2A (XU52C/K)	02-1992 →	81512
	69	07/89 → 12/93	1.580	B	M	4	8	B2A (XU52C/K)	→ 01-1992	81554
	69	07/89 → 12/93	1.580	B	M	4	8	B2A (XU52C/K)	02-1992 →	81512
1.6 GTi	85	09/89 → 10/93	1.580	B	M	4	8		→ 01-1992	81554
	85	09/89 → 10/93	1.580	B	M	4	8		02-1992 →	81512
1.8 Diesel	44	07/89 → 12/93	1.769	D	M	4	8	161A (XUD7)		81672
1.8 TD	57	08/89 → 12/93	1.769	D	M	4	8	A8B (XUD7TE)		81672
1.9	72	08/89 → 12/93	1.905	B	M	4	8	DFZ (XU9J1)	→ 01-1992	81554
	72	08/89 → 12/93	1.905	B	M	4	8	DFZ (XU9J1)	02-1992 →	81512
	80	10/90 → 12/93	1.905	B	M	4	8	DDZ (XU9M)	→ 01-1992	81554
	80	10/90 → 12/93	1.905	B	M	4	8	DDZ (XU9M)	02-1992 →	81512
1.9 Diesel	47	07/89 → 12/93	1.905	D	M	4	8	162 (XUD9), D9A (XUD9), DJZ (XUD9Y)		81672
1.9 GTI	88	07/89 → 12/93	1.905	B	M	4	8	DKZ (XU9JAZ)	→ 01-1992	81554
	88	07/89 → 12/93	1.905	B	M	4	8	DKZ (XU9JAZ)	02-1992 →	81512
1.9 GTI 16V	108	10/90 → 12/93	1.905	B	M	4	16	DFW (XU9J4Z)		81512
	116	08/89 → 07/90	1.905	B	M	4	16	D6C (XU9J4)		81512

**405 I, Station Wagon**

1.4	47	01/87 → 07/92	1.360	B	M	4	8	K5A (TU3)		81556
-----	----	---------------	-------	---	---	---	---	-----------	--	-------

**KW**

**cm<sup>3</sup>**

**NO. OF VALVES**

**MAGNETI MARELLI**
**PEUGEOT**
**405 I, Station Wagon**

1.6	53	07/87 → 12/92	1.580	B	M	4	8	B1E (XU51C)		81554
	55	10/88 → 08/92	1.580	B	M	4	8	BAZ (XU5CP)		81554
	65	10/88 → 08/92	1.580	B	M	4	8	BDY (XU5M2Z), BDY (XU5M3Z), BDZ (XU5M)		81554
	65	07/87 → 12/92	1.580	B	M	4	8	BDY (XU5M2Z), BDZ (XU5M)		81554
	66	10/89 → 12/92	1.580	B	M	4	8	BDZ (XU5M)		81554
	69	01/87 → 12/92	1.580	B	M	4	8	B2A (XU52C/K)		81554
	69	10/88 → 08/92	1.580	B	M	4	8			81554
1.6 4x4	65	04/88 → 07/92	1.580	B	M	4	8	BDZ (XU5M)		81554
1.6 SRi 4x4	65	04/88 → 07/92	1.580	B	M	4	8	BDZ (XU5M)		81554
1.8 GLD	44	04/90 → 07/92	1.769	D	M	4	8			81672
1.8 TD	66	10/88 → 08/92	1.769	D	M	4	8	A8A (XUD7TE), AJZ (XUD7TEY)		81672
1.8 Turbo Diesel	66	03/88 → 12/92	1.769	D	M	4	8	A8A (XUD7TE), AJZ (XUD7TEY)		81672
1.9	70	07/87 → 12/92	1.905	B	M	4	8	D2C (XU92C)		81554
	77	10/88 → 08/92	1.905	B	M	4	8	DFZ (XU9J1)		81554
	80	07/88 → 12/92	1.905	B	M	4	8	DDZ (XU9M)		81554
	88	07/88 → 12/92	1.905	B	M	4	8	DKZ (XU9JAZ)		81554
	93	07/87 → 12/93	1.905	B	M	4	8	D6A (XU9J2)		81554
1.9 4x4	80	07/88 → 12/92	1.905	B	M	4	8	DDZ (XU9M)		81554
	88	06/87 → 07/92	1.905	B	M	4	8	DKZ (XU9JAZ)		81554
	93	07/90 → 07/92	1.905	B	M	4	8			81554
	108	07/90 → 07/92	1.905	B	M	4	16			81512
	116	06/87 → 07/92	1.905	B	M	4	16	D6C (XU9J4)		81512
1.9 D	47	10/88 → 08/92	1.905	D	M	4	8	DJZ (XUD9Y)	→ 07-1992	81672
	51	10/88 → 08/92	1.905	D	M	4	8	D9B (XUD9A), DJY (XUD9A)	→ 07-1992	81672
1.9 Diesel	47	07/88 → 09/92	1.905	D	M	4	8	DJZ (XUD9Y)		81672
	51	03/88 → 12/92	1.905	D	M	4	8	D9B (XUD9A)		81672
1.9 Injection	77	07/87 → 12/92	1.905	B	M	4	8	DFZ (XU9J1)		81554
1.9 Sport MI-16	108	04/88 → 12/92	1.905	B	M	4	16	DFW (XU9J4Z)		81512
	116	07/87 → 11/91	1.905	B	M	4	16	D6C (XU9J4)		81512
1.9 SPort MI-16 4x4	108	04/88 → 12/92	1.905	B	M	4	16	DFW (XU9J4Z)		81512
<b>405 II, Station Wagon</b>										
1.4	55	08/92 → 10/95	1.361	B	M	4	8	KDX (TU3MC)		81513
1.6	65	08/92 → 10/95	1.580	B	M	4	8	BDY (XU5M2Z), BDY (XU5M3Z), BDZ (XU5M), BFZ (XU5JP)		81512
1.8	74	08/92 → 10/95	1.762	B	M	4	8	LFZ (XU7JP)		81512

**KW**

**cm<sup>3</sup>**

**NO. OF VALVES**

**PEUGEOT**
**405 II, Station Wagon**

1.9 D	47	08/92 → 10/95	1.905	D	M	4	8	DJZ (XUD9Y)		81512
	50	06/94 → 10/95	1.905	D	M	4	8	DJY (XUD9A)		81512
1.9 TD	66	08/92 → 10/95	1.905	D	M	4	8	DHY (XUD9TE)		81512
2.0	89	08/92 → 10/95	1.998	B	M	4	8	RFX (XU10J2)		81642
2.0 16V	110	06/94 → 10/95	1.998	B	M	4	16	RFT (XU10J4)		81642
2.0 4x4	89	08/92 → 10/96	1.998	B	M	4	8	RFX (XU10J2)		81642
2.0 MI-16	112	08/92 → 10/95	1.998	B	M	4	16	RFY (XU10J4Z)		81642
2.0 T 16 X4	144	08/92 → 10/95	1.998	B	M	4	16	RGZ (XU10J4TE/Z)		81642
2.0 X4	89	08/92 → 10/95	1.998	B	M	4	8	RFX (XU10J2)		81642

**407, Station Wagon, Coupé**

1.6	65	11/95 → 05/04	1.580	B	M	4	8	BFZ (XU5JP)		81512
1.6 HDi 110	80	05/04 →	1.560	D	M	4	16	9HZ (DV6TED4)		81869
1.8	85	05/04 →	1.749	B	M	4	16	6FZ (EW7J4)	(-)COP	84038 <b>NEW</b>
	85	05/04 →	1.749	B	M	4	16	6FZ (EW7J4)	(+)COP	82089
	85	05/04 →	1.749	B	M	4	16	6FZ (EW7J4)		82089
	85	05/04 →	1.749	B	M	4	16	6FZ (EW7J4)		81799
	66	05/97 → 05/04	1.761	B	AM	4	8	LFX (XU7JB)		81512
	66	05/97 → 10/04	1.761	B	M	4	8	LFX (XU7JB)	06-1997 →	81512
1.8 16V	85	10/00 → 05/04	1.749	B	M	4	16	6FZ (EW7J4)		81710
	92	09/05 →	1.749	B	M	4	16	6FY (EW7A)	(-)COP	84038 <b>NEW</b>
	92	09/05 →	1.749	B	M	4	16	6FY (EW7A)	(+)COP	82089
	92	09/05 →	1.749	B	M	4	16	6FY (EW7A)		82089
	92	09/05 →	1.749	B	M	4	16	6FY (EW7A)		81799
	81	11/95 → 10/00	1.761	B	M	4	16	LFY (XU7JP4)		81710
1.9 D	55	10/96 → 05/04	1.905	D	M	4	8	DHW (XUD9SD)		81642
1.9 TD	66	01/96 → 05/04	1.905	D	M	4	8	DHX (XUD9TE)		81642
	68	01/96 → 05/04	1.905	D	M	4	8	DHY (XUD9TE)		81642
2.0	100	05/04 →	1.997	B	M	4	16	RFN (EW10J4)	(-)COP	84038 <b>NEW</b>
	100	05/04 →	1.997	B	M	4	16	RFN (EW10J4)	(+)COP	82089
	100	05/04 →	1.997	B	M	4	16	RFN (EW10J4)		82089
	100	05/04 →	1.997	B	M	4	16	RFN (EW10J4)		81799
	104	11/96 → 03/99	1.998	B	M	4	8	RGY (XU10J2TE)		81711

**KW**

**cm<sup>3</sup>**

**NO. OF VALVES**

**MAGNETI MARELLI**
**PEUGEOT**
**407, Station Wagon, Coupé**

2.0 16V	99	01/99 → 08/00	1.997	B	M	4	16	RFR (DEW10J4)	(-)COP	84038	<b>NEW</b>
	99	01/99 → 08/00	1.997	B	M	4	16	RFR (DEW10J4)	(+)COP	82089	
	99	01/99 → 08/00	1.997	B	M	4	16	RFR (DEW10J4)		82089	
	99	01/99 → 08/00	1.997	B	M	4	16	RFR (DEW10J4)		81799	
	100	08/00 → 06/04	1.997	B	M	4	16	RFN (EW10J4)	(-)COP	84038	<b>NEW</b>
	100	08/00 → 06/04	1.997	B	M	4	16	RFN (EW10J4)	(+)COP	82089	
	100	08/00 → 06/04	1.997	B	M	4	16	RFN (EW10J4)		82089	
	100	08/00 → 06/04	1.997	B	M	4	16	RFN (EW10J4)		81799	
	100	10/00 → 12/04	1.997	B	M	4	16	RFN (EW10J4), RFV (XU10J4R)	(-)COP	84038	<b>NEW</b>
	100	10/00 → 12/04	1.997	B	M	4	16	RFN (EW10J4), RFV (XU10J4R)	(+)COP	82089	
	100	10/00 → 12/04	1.997	B	M	4	16	RFN (EW10J4), RFV (XU10J4R)		82089	
	100	10/00 → 12/04	1.997	B	M	4	16	RFN (EW10J4), RFV (XU10J4R)		81799	
	103	09/05 →	1.997	B	M	4	16	RFJ (EW10A)	(-)COP	84038	<b>NEW</b>
	103	09/05 →	1.997	B	M	4	16	RFJ (EW10A)	(+)COP	82089	
	103	09/05 →	1.997	B	M	4	16	RFJ (EW10A)		82089	
	103	09/05 →	1.997	B	M	4	16	RFJ (EW10A)		81799	
	97	11/95 → 05/04	1.998	B	M	4	16	RFV (XU10J4R)	(-)COP	84038	<b>NEW</b>
	97	11/95 → 05/04	1.998	B	M	4	16	RFV (XU10J4R)	(+)COP	82089	
	97	11/95 → 05/04	1.998	B	M	4	16	RFV (XU10J4R)	→ 03-1999	81711	
	97	11/95 → 05/04	1.998	B	M	4	16	RFV (XU10J4R)	04-1999 →	81799	
97	11/95 → 05/04	1.998	B	M	4	16	RFV (XU10J4R)		82089		
97	03/97 → 12/04	1.998	B	M	4	16	RFV (XU10J4R)	→ 12-1999	81711		
99	04/99 → 09/04	1.998	B	M	4	16	RFV (XU10J4R)		81711		
2.0 16V HPi	103	05/01 → 05/04	1.997	B	M	4	16	RLZ (EW10D)	(-)COP	84038	<b>NEW</b>
	103	05/01 → 05/04	1.997	B	M	4	16	RLZ (EW10D)	(+)COP	82089	
	103	05/01 → 05/04	1.997	B	M	4	16	RLZ (EW10D)		82089	
	103	05/01 → 05/04	1.997	B	M	4	16	RLZ (EW10D)		81799	
2.0 Bioflex	103	09/07 →	1.997		M	4	16	RFJ (EW10A)	(-)COP	84038	<b>NEW</b>
	103	09/07 →	1.997		M	4	16	RFJ (EW10A)	(+)COP	82089	
	103	09/07 →	1.997		M	4	16	RFJ (EW10A)		82089	
	103	09/07 →	1.997		M	4	16	RFJ (EW10A)		81799	
2.0 HDi	100	10/05 →	1.997	D	M	4	16	RHR (DW10BTED4)		81800	
	103	08/08 →	1.997	D	M	4	16	RHF (DW10BTED4)		81800	
	103	08/08 →	1.997	D	M	4	16	RHR (DW10BTED4)		81800	
	110	02/10 →	1.997	D	M	4	16	RHE (DW10CTED4)		81800	
	120	07/09 →	1.997	D	M	4	16	RHH (DW10CTED4)		81800	
2.0 HDi 110	79	08/01 → 05/04	1.997	D	M	4	8	RHS (DW10ATED), RHZ (DW10ATED)		81713	
	80	06/98 → 08/01	1.997	D	M	4	8	RHZ (DW10ATED)		81713	
2.0 HDi 135	100	05/04 →	1.997	D	M	4	16	RHR (DW10BTED4)		81800	

		<b>KW</b>		<b>cm<sup>3</sup></b>				<b>NO. OF VALVES</b>		
--	--	-----------	--	-----------------------	--	--	--	----------------------	--	--

## PEUGEOT

### 407, Station Wagon, Coupé

2.0 HDi 90	66	02/99 → 05/04	1.997	D	M	4	8	RHY (DW10TD)		81713
2.0 Turbo	108	04/96 → 05/04	1.998	B	M	4	8	RGX (XU10J2TE)		81642
2.1 TD 12V	80	01/96 → 05/04	2.088	D	M	4	12	P8C (XUD11BTE)		81353
2.2	116	07/00 → 05/04	2.230	B	M	4	16	3FZ (EW12J4)	(-)COP	84038 <b>NEW</b>
	116	07/00 → 05/04	2.230	B	M	4	16	3FZ (EW12J4)	(+)COP	82089
	116	07/00 → 05/04	2.230	B	M	4	16	3FZ (EW12J4)		82089
	116	07/00 → 05/04	2.230	B	M	4	16	3FZ (EW12J4)		81799
2.2 16V	120	09/05 →	2.230	B	M	4	16	3FY (EW12J4)	(-)COP	84038 <b>NEW</b>
	120	09/05 →	2.230	B	M	4	16	3FY (EW12J4)	(+)COP	82089
	120	09/05 →	2.230	B	M	4	16	3FY (EW12J4)		82089
	120	09/05 →	2.230	B	M	4	16	3FY (EW12J4)		81799
2.2 HDi	98	03/00 → 05/04	2.179	D	M	4	16	4HX (DW12TED4/FAP)		81800
	120	06/08 →	2.179	D	M	4	16	4HP (DW12BTED4)		82068
2.2 HDi 170	125	05/06 →	2.179	D	M	4	16	4HT (DW12BTED4)		82068
2.7 HDi	150	10/05 →	2.720	D	M	6	24	UHZ (DT17)		82067
3.0	155	05/04 →	2.946	B	M	6	24	XFV (ES9A)		81813
3.0 24V	140	10/96 → 05/04	2.946	B	M	6	24	XFZ (ES9J4)	→ 12-1999, → T: 08441, → PROD: 8554	81844
	140	10/96 → 05/04	2.946	B	M	6	24	XFZ (ES9J4)	T →: 08442	82042
3.0 HDi	177	06/09 →	2.992	D	M	6	24	DT20C		84019 <b>NEW</b>
3.0 V6	152	03/00 → 05/04	2.946	B	M	6	24	XFV (ES9J4S)	PROD →: 8555	81813
	155	10/05 →	2.946	B	M	6	24	XFV (ES9A)		81813
3.0 V6 24V	140	03/97 → 12/04	2.946	B	M	6	24	XFZ (ES9J4)	→ T: 08441	81844
	140	03/97 → 12/04	2.946	B	M	6	24	XFZ (ES9J4)	T →: 08442	82042

### 508, Station Wagon

1.6	120	01/12 →	1.598	B	M	4	16	5GZ (EP6FDT)		82032
	121	09/11 →	1.598	B	M	4	16			82032
1.6 BlueHDi 120	88	03/14 →	1.560	D	M	4	8	BHZ (DV6FC)		81869
1.6 HDi	82	11/10 →	1.560	D	M	4	8	9HR (DV6C)		81869
	84	02/12 →	1.560	D	M	4	8	9HD (DV6CTED)		81869
	85	09/14 →	1.560	D	M	4	8	BHX (DV6FC)		81869
1.6 THP	110	11/10 →	1.598	B	M	4	16	5FN (EP6CDT)		82032
	110	11/10 →	1.598	B	M	4	16	5FX (EP6DT)		82032
	115	11/10 →	1.598	B	M	4	16	EP6CDT		82032
1.6 VTi	85	11/10 →	1.598	B	M	4	16	5FH (EP6C)		82032
	88	11/10 →	1.598	B	M	4	16	5FS (EP6C)		82032
2.0 BlueHDi 150	110	04/14 →	1.997	D	M	4	16	AHX (DW10FD)		82068
2.0 BlueHDi 180	133	04/14 →	1.997	D	M	4	16	AHW (DW10FC)		82068
2.0 HDi	100	11/10 →	1.997	D	M	4	16	RHR (DW10BTED4)		81800
	103	11/10 →	1.997	D	M	4	16	RHF (DW10BTED4)		84020 <b>NEW</b>
	120	11/10 →	1.997	D	M	4	16	RHH (DW10CTED4)		84020 <b>NEW</b>
2.0 HDi 180 RXH	133	10/14 →	1.997		M	4	16			82068



KW



cm<sup>3</sup>



NO. OF VALVES



MAGNETI MARELLI

## PEUGEOT

### 508, Station Wagon







2.0 HDi Hybrid4 AWC	120	11/10 →	1.997		M	4	16	RHC (DW10CTED4)		84020	<b>NEW</b>
	147	11/10 →	1.997		M	4	16			84020	<b>NEW</b>
2.0 HDi RXH Hybrid4	120	11/10 →	1.997		M	4	16	RHC (DW10CTED4)		84020	<b>NEW</b>
	147	12/11 →	1.997		M	4	16	RHC (DW10CTED4)		84020	<b>NEW</b>
2.2 HDi	150	11/10 →	2.179	D	M	4	16	4HL (DW12C)		82068	

### 605

2.0	79	02/90 → 09/99	1.998	B	M	4	8			81642	
	84	06/89 → 09/99	1.998	B	M	4	8	R5A (XU102C)		81642	
	89	06/89 → 09/99	1.998	B	M	4	8	RFZ (XU10J2Z)		81642	
2.0 16V	97	07/94 → 09/99	1.998	B	M	4	16	RFV (XU10J4R)		81711	
2.0 Turbo	104	07/92 → 09/99	1.998	B	M	4	8	RGY (XU10J2TE)		81642	
	108	07/91 → 09/99	1.998	B	M	4	8	RGX (XU10J2TE)		81642	
2.1 D	60	06/89 → 07/95	2.138	D	M	4	12	P9A (XUD11A)		81642	
2.1 TD 12V	80	08/94 → 09/99	2.088	D	M	4	12	P8C (XUD11BTE)		81353	
2.1 Turbo Diesel	80	06/89 → 09/99	2.088	D	M	4	12	PHZ (XUD11ATE)		81353	
2.5 Turbo Diesel	95	07/94 → 09/99	2.446	D	M	4	12	THY (DK5ATE)	→ 03-1995, → PROD: 7143	81752	
	95	07/94 → 09/99	2.446	D	M	4	12	THY (DK5ATE)	04-1995 →, PROD →: 7144	81712	

### 607

2.0	100	02/00 →	1.997	B	M	4	16	RFN (EW10J4)	(-)COP	84038	<b>NEW</b>
	100	02/00 →	1.997	B	M	4	16	RFN (EW10J4)	(+)COP	82089	
	100	02/00 →	1.997	B	M	4	16	RFN (EW10J4)		82089	
	100	02/00 →	1.997	B	M	4	16	RFN (EW10J4)		81799	
2.0 HDi	79	03/01 → 07/04	1.997	D	M	4	8	RHS (DW10ATED)		81713	
	80	05/00 →	1.997	D	M	4	8	RHZ (DW10ATED)		81713	
	100	09/05 →	1.997	D	M	4	16	RHR (DW10BTED4)		81800	
2.2 16V	116	02/00 →	2.230	B	M	4	16	3FZ (EW12J4)	(-)COP	84038	<b>NEW</b>
	116	02/00 →	2.230	B	M	4	16	3FZ (EW12J4)	(+)COP	82089	
	116	02/00 →	2.230	B	M	4	16	3FZ (EW12J4)		82089	
	116	02/00 →	2.230	B	M	4	16	3FZ (EW12J4)		81799	
	120	09/05 →	2.230	B	M	4	16	3FY (EW12J4)	(-)COP	84038	<b>NEW</b>
	120	09/05 →	2.230	B	M	4	16	3FY (EW12J4)	(+)COP	82089	
	120	09/05 →	2.230	B	M	4	16	3FY (EW12J4)		82089	
2.2 HDi	98	02/00 →	2.179	D	M	4	16	4HX (DW12TED4/FAP)		81800	
	125	05/06 →	2.179	D	M	4	16	4HT (DW12BTED4)		82068	
	150	12/04 →	2.721	D	M	6	24	DT17TED4		82067	
3.0 V6 24V	152	02/00 →	2.946	B	M	6	24	XFX (ES9J4S)		81813	
	155	03/04 →	2.946	B	M	6	24	XFV (ES9A), XFX (ES9J4S)		81813	

	<b>KW</b>		<b>cm<sup>3</sup></b>				<b>NO. OF VALVES</b>			<b>MAGNETI MARELLI</b>
---	-----------	---	-----------------------	---	---	---	----------------------	--	---	----------------------------

**PEUGEOT**
**806**

1.8	73	07/95 → 08/02	1.761	B	M	4	8	LFW (XU7JP)		81512
1.9 TD	66	07/95 → 08/02	1.905	D	M	4	8	DHX (XUD9TE)		81642
	68	05/97 → 08/02	1.905	D	M	4	8	DHY (XUD9TE)		81642
2.0	89	06/94 → 08/02	1.998	B	M	4	8	RFU (XU10J2)		81642
2.0 16V	100	09/00 → 08/02	1.997	B	M	4	16	RFN (EW10J4)	(-)COP	84038 <b>NEW</b>
	100	09/00 → 08/02	1.997	B	M	4	16	RFN (EW10J4)	(+)COP	82089
	100	09/00 → 08/02	1.997	B	M	4	16	RFN (EW10J4)		82089
	100	09/00 → 08/02	1.997	B	M	4	16	RFN (EW10J4)		81799
	97	05/98 → 09/00	1.998	B	M	4	16	RFV (XU10J4R)		81711
2.0 HDI	80	08/99 → 08/02	1.997	D	M	4	8	RHZ (DW10ATED)		81713
2.0 HDI 16V	80	08/99 → 08/02	1.997	D	M	4	16	RHW (DW10ATED4)		81713
2.0 Turbo	108	06/94 → 08/02	1.998	B	M	4	8	RGX (XU10J2TE)		81642
2.1 td 12V	80	06/96 → 08/99	2.088	D	M	4	12	P8C (XUD11BTE)		81353

**807**

2.0	100	06/02 →	1.997	B	M	4	16	RFN (EW10J4)	(-)COP	84038 <b>NEW</b>
	100	06/02 →	1.997	B	M	4	16	RFN (EW10J4)	(+)COP	82089
	100	06/02 →	1.997	B	M	4	16	RFN (EW10J4)		82089
	100	06/02 →	1.997	B	M	4	16	RFN (EW10J4)		81799
2.0 16V	103	09/05 →	1.997	B	M	4	16	RFJ (EW10A)	(-)COP	84038 <b>NEW</b>
	103	09/05 →	1.997	B	M	4	16	RFJ (EW10A)	(+)COP	82089
	103	09/05 →	1.997	B	M	4	16	RFJ (EW10A)		82089
	103	09/05 →	1.997	B	M	4	16	RFJ (EW10A)		81799
2.0 HDi	79	06/02 →	1.997	D	M	4	16	RHM (DW10ATED4), RHT (DW10ATED4), RHW (DW10ATED4)		81713
	80	04/04 → 05/06	1.997	D	M	4	16	RHW (DW10ATED4)		81800
	88	02/06 →	1.997	D	M	4	16	RHK (DW10UTED4)		81800
	100	06/06 →	1.997	D	M	4	16	RHR (DW10BTED4)		81800
	120	06/09 →	1.997	D	M	4	16	RHH (DW10CTED4)		84020 <b>NEW</b>
2.2	116	06/02 →	2.230	B	M	4	16	3FZ (EW12J4)	(-)COP	84038 <b>NEW</b>
	116	06/02 →	2.230	B	M	4	16	3FZ (EW12J4)	(+)COP	82089
	116	06/02 →	2.230	B	M	4	16	3FZ (EW12J4)		82089
	116	06/02 →	2.230	B	M	4	16	3FZ (EW12J4)		81799
2.2 HDi	94	06/02 →	2.179	D	M	4	16	4HW (DW12BTED4), 4HX (DW12TED4/FAP)		81800
	120	06/06 →	2.179	D	M	4	16	4HT (DW12BTED4)		82068
	125	06/06 →	2.179	D	M	4	16	4HT (DW12BTED4)		82068
3.0 V6	150	06/02 →	2.946	B	M	6	24	XFX (ES9J4S)		81813

**1007**

1.4	54	04/05 →	1.360	B	M	4	8	KFV (TU3JP)		81797
1.4 16V	65	10/05 →	1.360	B	M	4	16	KFU (ET3J4)		81797
1.4 HDi	50	04/05 →	1.398	D	M	4	8	8HX (DV4TD), 8HZ (DV4TD)		81798
1.6 16V	80	04/05 →	1.587	B	M	4	16	NFU (TU5JP4)		81753



KW



cm<sup>3</sup>



NO. OF VALVES



MAGNETI MARELLI

## PEUGEOT

### 1007

1.6 HDi	80	06/07 →	1.560	D	M	4	16	9HZ (DV6TED4)		81869
---------	----	---------	-------	---	---	---	----	---------------	--	-------

### 2008

1.2 THP 110	81	01/15 →	1.199	B	M	3	12	HNZ (EB2DT)		84066	<b>NEW</b>
1.2 THP 130	96	01/15 →	1.199	B	M	3	12	HNY (EB2DTS)		84066	<b>NEW</b>
1.2 VTi	60	03/13 →	1.199	B	M	3	12	HMZ (EB2F)		84066	<b>NEW</b>
1.4 HDi	50	06/13 →	1.398	D	M	4	8	8HR (DV4C)		81798	
1.6 BlueHDi 100	73	01/15 →	1.560	D	M	4	8	BHY (DV6FD)		81869	
1.6 BlueHDi 120	88	07/14 →	1.560	D	M	4	8	BHZ (DV6FC)		81869	
1.6 BlueHDi 75	55	01/15 →	1.560	D	M	4	8	BHW (DV6FE)		81869	
1.6 HDi	68	03/13 →	1.560	D	M	4	8	9HP (DV6DTED)		81869	
	84	03/13 →	1.560	D	M	4	8	9HD (DV6CTED)		81869	
	85	07/14 →	1.560	D	M	4	8	BHX (DV6FC)		81869	
1.6 VTi	88	03/13 →	1.598	B	M	4	16	5FS (EP6C)		82032	

### 3008

1.2	96	01/15 →	1.199	B	M	3	12	HNY (EB2DTS)		84066	<b>NEW</b>
1.6 BlueHDi 120	88	05/14 →	1.560	D	M	4	8	BHZ (DV6FC)		81869	
1.6 HDi	80	06/09 →	1.560	D	M	4	16	9HZ (DV6TED4)		81869	
	82	08/10 →	1.560	D	M	4	8	9HR (DV6C)		81869	
	84	03/13 →	1.560	D	M	4	8	9HD (DV6CTED)		81869	
1.6 THP	110	06/09 →	1.598	B	M	4	16	5FX (EP6DT)		82032	
	115	06/09 →	1.598	B	M	4	16	5FV (EP6DT)		82032	
1.6 Turbo	121	05/14 →	1.598	B	M	4	16	5GZ (EP6FDT)		82032	
1.6 VTi	88	06/09 →	1.598	B	M	4	16	5FS (EP6C), 5FW (EP6), EP6		82032	
2.0 HDi	100	09/11 →	1.997	D	M	4	16			84020	<b>NEW</b>
	120	06/09 →	1.997	D	M	4	16	RHH (DW10CTED4)		84020	<b>NEW</b>
2.0 HDi 150 / BlueHDi 150	110	06/09 →	1.997	D	M	4	16	AHX (DW10FD), RHE (DW10CTED4)		84020	<b>NEW</b>
2.0 HDi Hybrid4	120	02/11 →	1.997		M	4	16	RHC (DW10CTED4)		84020	<b>NEW</b>

### 4007

2.2 HDi	115	02/07 →	2.179	D	M	4	16	4HK (DW12MTED4), 4HN (DW12MTED4)		82068	
---------	-----	---------	-------	---	---	---	----	-------------------------------------	--	-------	--

### 4008

1.6 HDi AWC	84	05/12 →	1.560	D	M	4	8	9HD (DV6C)		81869	
1.8 HDi AWC	110	05/12 →	1.798	D	M	4	16			84042	<b>NEW</b>

### 5008

1.2	96	01/15 →	1.199	B	M	3	12	HNY (EB2DTS)		84066	<b>NEW</b>
1.6	120	02/12 →	1.598	B	M	4	16	5GZ (EP6FDT)		82032	
1.6 16V	88	09/09 →	1.598	B	M	4	16	5FS (EP6C), 5FW (EP6), EP6		82032	
	115	09/09 →	1.598	B	M	4	16	EP6CDT		82032	
1.6 BlueHDi 120	88	05/14 →	1.560	D	M	4	8	BHZ (DV6FC)		81869	



--	--	--	--	--	--	--	--	--	--

## PEUGEOT

### 5008

1.6 HDi	80	09/09 →	1.560	D	M	4	16	9HZ (DV6TED4)		81869
	82	08/10 →	1.560	D	M	4	8	9HR (DV6C)		81869
	84	03/13 →	1.560	D	M	4	8	9HD (DV6CTED)		81869
1.6 THP 150	110	02/12 →	1.598	B	M	4	16			82032
1.6 THP 165	121	02/12 →	1.598	B	M	4	16	5GZ (EP6FDT)		82032
2.0 HDi	120	09/09 →	1.997	D	M	4	16	RHH (DW10CTED4)		84020 <b>NEW</b>
2.0 HDi 136 / BlueHDi 136	100	02/12 →	1.997	D	M	4	16	AHV (DW10FD), RHD (DW10CTED4)		84020 <b>NEW</b>
2.0 HDi 150 / BlueHDi 150	110	06/09 →	1.997	D	M	4	16	AHX (DW10FD), RHE (DW10CTED4)		84020 <b>NEW</b>

### Bipper, Tepee

1.3 HDi 75	55	10/10 →	1.248	D	M	4	16	199A9.000		81862
1.4	54	02/08 →	1.360	B	M	4	8	KFV (TU3A)		81797
1.4 HDi	50	02/08 →	1.398	D	M	4	8	8HS (DV4TED)		81798

### Boxer I

1.9 D	50	07/99 → 04/02	1.905	D	M	4	8	DJY (XUD9A)		81642
	51	03/94 → 04/02	1.905	D	M	4	8	D9B (XUD9AU)		81642
1.9 DT 4x4	66	03/96 → 09/98	1.905	D	M	4	8	XUD9TE		81642
1.9 TD	66	08/94 → 04/02	1.905	D	M	4	8	DHY (XUD9TE)		81642
	66	06/94 → 04/02	1.905	D	M	4	8	DHY (XUD9TE), XUD9TE		81642
	66	07/99 → 04/02	1.905	D	M	4	8	XUD9TE		81642
	68	03/94 → 04/02	1.905	D	M	4	8	D8C (XUD9UTF)		81642
	68	07/94 → 04/02	1.905	D	M	4	8	D8C (XUD9UTF), XUD9TE		81642
1.9 TD 4x4	68	07/96 → 04/02	1.905	D	M	4	8	D8C (XUD9UTF)		81642
2.0	81	12/01 → 04/02	1.998	B	M	4	8	RFL (XU10J2U)		81642
2.0 4x4	80	03/96 → 09/98	1.998	B	M	4	8			81642
2.0 HDi	62	08/01 → 04/02	1.997	D	M	4	8	RHV (DW10UTD)		81713
2.0 i	80	03/94 → 04/02	1.998	B	M	4	8	RFW (XU10J2)		81642
2.0 i 4x4	80	08/96 → 04/02	1.998	B	M	4	8	RFW (XU10J2)		81642
2.5 D	63	08/94 → 04/02	2.446	D	M	4	8	T9A (DJ5)	→ 05-1996, → PROD: 7143	81752
	63	08/94 → 04/02	2.446	D	M	4	8	T9A (DJ5)	01-1999 →, M: SOFIM	81316
	63	08/94 → 04/02	2.446	D	M	4	8	T9A (DJ5)	06-1996 →, PROD →: 7144	81712
2.5 D 4x4	63	07/96 → 04/02	2.446	D	M	4	8	T9A (DJ5)	M: SOFIM	81316
	63	07/96 → 04/02	2.446	D	M	4	8	T9A (DJ5)		81712
2.5 DT	62	10/97 → 11/01	2.499	D	M	4	8			81712
2.5 TD	76	07/94 → 04/02	2.446	D	M	4	12	T8A (DJ5T)	→ 05-1996, → PROD: 7143	81752
	76	07/94 → 04/02	2.446	D	M	4	12	T8A (DJ5T)	06-1996 →, PROD →: 7144	81712

**KW**

**cm<sup>3</sup>**

**NO. OF VALVES**

**PEUGEOT**
**Boxer I**

2.5 TD 4x4	76	07/96 → 04/02	2.446	D	M	4	12	T8A (DJ5T)	M: SOFIM	81316
	76	07/96 → 04/02	2.446	D	M	4	12	T8A (DJ5T)		81712
2.5 TDI	79	01/97 → 04/02	2.446	D	M	4	8	THX (DJ5TED)		81712
2.5 TDI 4x4	79	01/97 → 04/02	2.446	D	M	4	8	THX (DJ5TED)		81712
2.8 D	64	01/99 → 02/02	2.798	D	M	4	8	8140.63 (F28D)		81316
2.8 HDi	93	10/00 → 11/01	2.798	D	M	4	8	8140.43S (F28DTCR)		81316
	94	11/00 → 04/02	2.798	D	M	4	8	8140.43S (F28DTCR)		81316
2.8 HDi 4x4	93	10/00 → 11/01	2.798	D	M	4	8	8140.43S (F28DTCR)		81316
	94	10/00 → 04/02	2.798	D	M	4	8	8140.43S (F28DTCR)		81316
2.8 HDi Trazione integrale	93	10/00 → 11/01	2.798	D	M	4	8	8140.43S (F28DTCR)		81316

**Boxer II**

2.0	81	04/02 →	1.998	B	M	4	8	RFL (XU10J2U)		81642
2.0 HDi	62	04/02 →	1.997	D	M	4	8	RHV (DW10TD), RHV (DW10UTD)		81713
2.2 HDi	74	04/02 →	2.179	D	M	4	8	4HY (DW12UTED)		81800
2.8 HDi	94	04/02 →	2.798	D	M	4	8	8140.43S (F28DTCR)		81316
	107	04/04 →	2.798	D	M	4	8	8140.43N		81316
2.8 HDi 4x4	94	04/02 →	2.798	D	M	4	8	8140.43S (F28DTCR)		81316

**Boxer III**

2.2 HDi 100	74	04/06 →	2.198	D	M	4	16	4HV (P22DTE)		82066
2.2 HDi 110	81	03/11 →	2.198	D	M	4	16	4HG (P22DTE)		82066
2.2 HDi 120	88	04/06 →	2.198	D	M	4	16	4HU (P22DTE)		82066
2.2 HDi 130	96	03/11 →	2.198	D	M	4	16	4HH (P22DTE)		82066
2.2 HDi 150	110	03/11 →	2.198	D	M	4	16	4HJ (P22DTE)		82066
3.0 HDi	115	07/06 →	2.998	D	M	4	16	F1CE0481D (F30DT)		82094
3.0 HDi 145	107	04/10 →	2.999	D	M	4	16			82094
3.0 HDi 160	116	04/06 →	2.999	D	M	4	16	F1CE0481D (F30DT)		82094
3.0 HDi 175	130	03/11 →	2.999	D	M	4	16	F1CE0481D (F30DT)		82094

**Expert I**

1.6	58	02/96 →	1.581	B	M	4	8	222A2 (1580SPI)	(-)COP	81368
	58	02/96 →	1.581	B	M	4	8	222A2 (1580SPI)	(+)COP	81346
1.8	74	10/96 → 09/00	1.761	B	M	4	8	LFZ (XU7JP)		81512
1.9 D	51	06/98 → 11/03	1.868	D	M	4	8	WJY (DW8B), WJZ (DW8)		81642
	51	12/03 →	1.868	D	M	4	8	WJY (DW8B), WJZ (DW8)		81713
	51	02/96 →	1.905	D	M	4	8	D9B (XUD9AU)		81642
1.9 D 70	51	12/98 →	1.868	D	M	4	8	WJY (DW8B), WJZ (DW8)		81713
1.9 TD	66	02/96 →	1.905	D	M	4	8	DHX (XUD9TE)		81642
	68	02/96 →	1.905	D	M	4	8	D8B (XUD9TE)		81642

		<b>KW</b>		<b>cm<sup>3</sup></b>				<b>NO. OF VALVES</b>		
--	--	-----------	--	-----------------------	--	--	--	----------------------	--	--

## PEUGEOT

### Expert I

2.0	100	07/00 →	1.997	B	M	4	16	RFN (EW10J4)	(-)COP	84038	<b>NEW</b>
	100	07/00 →	1.997	B	M	4	16	RFN (EW10J4)	(+)COP	82089	
	100	07/00 →	1.997	B	M	4	16	RFN (EW10J4)		82089	
	100	07/00 →	1.997	B	M	4	16	RFN (EW10J4)		81799	
2.0 HDi	69	07/00 →	1.997	D	M	4	8	RHX (DW10BTED)		81800	
	69	10/00 → 11/03	1.997	D	M	4	8	RHX (DW10BTED)		81713	
	80	07/00 →	1.997	D	M	4	16	RHW (DW10ATED4)		81800	
	80	10/00 → 10/06	1.997	D	M	4	16	RHW (DW10ATED4)		81713	
	80	07/00 →	1.997	D	M	4	8	RHZ (DW10ATED), RHZ (DW10BTED), RHZ (DW10CTED)		81713	
	80	07/00 →	1.997	D	M	4	8	RHZ (DW10ATED), RHZ (DW10BTED), RHZ (DW10CTED)		81800	
2.0 HDi 16V	80	07/00 →	1.997	D	M	4	16	RHW (DW10ATED4)		81713	

### Expert II, Tepee

1.6 HDi 90	66	01/07 →	1.560	D	M	4	16	9HU (DV6UTED4)		81869	
1.6 HDi 90 16V	66	01/07 →	1.560	D	M	4	16	9HU (DV6UTED4)		81869	
2.0 16V	103	01/07 →	1.997	B	M	4	16	RFH (EW10A), RFJ (EW10A)	(-)COP	84038	<b>NEW</b>
	103	01/07 →	1.997	B	M	4	16	RFH (EW10A), RFJ (EW10A)	(+)COP	82089	
	103	01/07 →	1.997	B	M	4	16	RFH (EW10A), RFJ (EW10A)		82089	
	103	01/07 →	1.997	B	M	4	16	RFH (EW10A), RFJ (EW10A)		81799	
2.0 HDi 100	72	03/11 →	1.997	D	M	4	16	AHY (DW10CE)		84020	<b>NEW</b>
2.0 HDi 120	88	01/07 →	1.997	D	M	4	16	RHK (DW10UTED4)		81800	
2.0 HDi 120 4x4	88	01/07 →	1.997	D	M	4	16	RHK (DW10UTED4)		84020	<b>NEW</b>
2.0 HDi 130	94	03/11 →	1.997	D	M	4	16	AHZ (DW10CD)		84020	<b>NEW</b>
2.0 HDi 140	100	01/07 →	1.997	D	M	4	16	RHR (DW10BTED4)		81800	
2.0 HDi 165	120	09/09 →	1.997	D	M	4	16	RHH (DW10CTED4)		84020	<b>NEW</b>

### J5 I

2.0	55	09/81 → 09/90	1.971	B	M	4	8	170B (XN1T)		81367	
	55	09/87 → 08/90	1.971	B	M	4	8	XN1T		81367	
	58	01/83 → 09/90	1.971	B	M	4	8	170 (XN1T)		81367	
	58	09/81 → 08/90	1.971	B	M	4	8	XN1P		81367	
2.5 D	54	09/81 → 08/90	2.498	D	M	4	8	CRD93		81822	
	54	09/81 → 09/90	2.498	D	M	4	8	CRD93 (U25/661)		81822	
2.5 DT	70	09/81 → 08/90	2.498	D	M	4	8	CRD93L, CRD93LS (U25/673)		81822	

**KW**

**cm<sup>3</sup>**

**NO. OF VALVES**

**PEUGEOT**
**J5 II**

1.9 D	51	10/90 → 02/94	1.905	D	M	4	8	D9B (XUD9A)		81672
2.0	62	10/90 → 02/94	1.971	B	M	4	8	170D (XN1TACP)	09-1981 →, → 01-1994	81367
	62	10/90 → 02/94	1.971	B	M	4	8	170D (XN1TACP)		81367
	62	09/90 → 01/94	1.971	B	M	4	8	170D (XN1TACP), XN1TA		81367
2.5 D	54	09/90 → 01/94	2.498	D	M	4	8	CRD93		81822
	54	10/90 → 02/94	2.500	D	M	4	8	CRD93 (U25/661)		81822
2.5 D 4x4	54	10/90 → 02/94	2.500	D	M	4	8	CRD93 (U25/661)		81822
2.5 DT	70	09/90 → 01/94	2.498	D	M	4	8	CRD93L		81822
2.5 TD	70	10/90 → 02/94	2.500	D	M	4	8	CRD93LS (U25/673)		81822
2.5 TD 4x4	70	10/90 → 02/94	2.500	D	M	4	8	CRD93LS (U25/673)		81822

**Partner I**

1.1	44	06/96 →	1.124	B	M	4	8	HDZ (TU1M)	→ 10-2002	81556
	44	06/96 →	1.124	B	M	4	8	HDZ (TU1M)	11-2002 →	81797
	44	06/96 →	1.124	B	M	4	8	HDZ (TU1M), HFX (TU1JP)	→ 10-2002	81556
	44	06/96 →	1.124	B	M	4	8	HDZ (TU1M), HFX (TU1JP)	11-2002 →	81797
1.4	54	11/02 → 10/06	1.360	B	M	4	8	KFW (TU3JP)		81797
	55	06/96 →	1.360	B	M	4	8	KFW (TU3JP), KFX (TU3JP), TU32	→ 10-2002	81556
	55	06/96 →	1.360	B	M	4	8	KFW (TU3JP), KFX (TU3JP), TU32	11-2002 →	81797
	55	06/96 →	1.360	B	M	4	8	KFX (TU3JP), TU32	→ 10-2002	81556
	55	06/96 →	1.360	B	M	4	8	KFX (TU3JP), TU32	11-2002 →	81797
1.4 BiFuel	55	04/03 →	1.360	BF	M	4	8	KFW (TU3JP)	→ M: 3.666.765	81556
	55	04/03 →	1.360	BF	M	4	8	KFW (TU3JP)	M → : 3.666.766	81797
1.6	80	09/00 → 10/02	1.587	B	M	4	16	NFU (TU5JP4)		81753
1.6 16V	80	07/01 →	1.587	B	M	4	16	NFU (TU5JP4)		81753
1.6 HDi 75	55	02/06 →	1.560	D	M	4	16	9HW (DV6BTED4)		81869
1.6 HDi 90	66	10/05 →	1.560	D	M	4	16	9HX (DV6ATED4)		81869
1.8	66	05/97 →	1.761	B	M	4	8	LFX (XU7JB)	03-1997 →	81512
1.8 D	43	06/96 →	1.769	D	M	4	8	A9A (XUD7)	03-1997 →	81512
	44	11/96 → 02/98	1.769	D	M	4	8	A9A (XUD7)		81642
1.9 D	51	06/96 →	1.868	D	M	4	8	WJY (DW8B), WJZ (DW8)		81713
	51	12/98 →	1.868	D	M	4	8	WJY (DW8B), WJZ (DW8)		81642
	50	06/96 →	1.905	D	M	4	8	DJY (XUD9A)		81642
	51	06/96 →	1.905	D	M	4	8	DJY (XUD9A)		81642
	51	05/96 → 12/98	1.905	D	M	4	8	XUD9		81642
1.9 D 4x4	51	04/04 → 08/05	1.868	D	M	4	8	WJY (DW8B)		81713
2.0 HDI	66	02/00 →	1.997	D	M	4	8	RHY (DW10TD)		81713

--	--	--	--	--	--	--	--	--	--

## PEUGEOT

### Partner I

2.0 HDi 4x4	66	04/04 → 08/05	1.997	D	M	4	8	RHY (DW10TD)	81800
	66	04/04 →	1.997	D	M	4	8	RHY (DW10TD)	81713

### Partner II, Tepee

1.6	66	04/08 →	1.587	B	M	4	16	NFR (TU5JP4B)	81753
	80	04/08 →	1.587	B	M	4	16	NFU (TU5JP4)	81753
	72	08/10 →	1.598	B	M	4	16	5FK (EP6CB)	81753
	72	11/10 →	1.598	B	M	4	16	5FK (EP6CB)	82032
	88	04/10 →	1.598	B	M	4	16	5FS (EP6C)	81753
1.6 HDi	55	04/08 →	1.560	D	M	4	16	9HN (DV6ETED4), 9HT (DV6BTED4), 9HW (DV6BTED4)	81869
	55	04/08 →	1.560	D	M	4	16	9HT (DV6BTED4), 9HW (DV6BTED4)	81869
	80	04/08 →	1.560	D	M	4	16	9HZ (DV6TED4)	81869
	82	08/10 →	1.560	D	M	4	8	9HL (DV6C)	81869
	84	03/13 →	1.560	D	M	4	8	9HL (DV6C)	81869
1.6 HDi 16V	66	04/08 →	1.560	D	M	4	16	9HS (DV6TED4BU), 9HX (DV6ATED4)	81869
	66	04/08 →	1.560	D	M	4	16	9HV (DV6TED4), 9HX (DV6ATED4)	81869
1.6 HDi 16V 4x4	66	04/12 →	1.560	D	M	4	16	9HS (DV6TED4BU), 9HX (DV6ATED4)	81869
1.6 HDi 90	68	04/10 →	1.560	D	M	4	8	9HP (DV6DTED)	81869
	68	04/10 →	1.560	D	M	4	8	9HP (DV6DTED), 9HX (DV6ATED4)	81869

### RCZ

1.6 16V	115	03/10 →	1.598	B	M	4	16	EP6CDT	82032
	147	06/10 →	1.598	B	M	4	16	EP6CDTX	82032
1.6 THP 270	199	06/13 →	1.598	B	M	4	16	5FG (EP6CDTR)	82032
2.0 HDi	120	03/10 →	1.997	D	M	4	16	RHH (DW10CTED4)	84020

## PROTON

### Persona 400

416 i	70	12/95 →	1.597	B	M	4	16	4G92	81731
-------	----	---------	-------	---	---	---	----	------	-------

## PUCH

### G Model

290 GD/G 290 D	70	04/92 →	2.874	D	M	5	10	OM602.942	81506
300 GE	125	06/90 →	2.960	B	M	6	12	M103.987	81507
350 G Turbo D	100	09/91 →	3.449	D	M	6	12	OM603.972	81506
G 290 TD	88	07/97 →	2.874	D	M	5	10	OM602.983	81506

**KW**

**cm<sup>3</sup>**

**NO. OF VALVES**

**MAGNETI MARELLI**
**RENAULT**

<b>4</b>											
1.0	25	06/87 → 12/93	956	B	M	4	8	C1C708			81660
	31	12/85 → 06/93	956	B	M	4	8	689710			81660
	25	06/87 → 06/93	956	B	M	4	8	C1C708			81660
1.1	32	06/86 → 06/90	1.108	B	M	4	8	C1E714			81660
<b>19 I, Chamade, Cabrio</b>											
1.2	40	01/88 → 12/92	1.237	B	M	4	8	C1G730		(-)COP	81573
	40	01/88 → 12/92	1.237	B	M	4	8	C1G730		(+)COP	81811
1.4	55	09/90 → 04/92	1.390	B	M	4	8	E7J700			81661
	57	07/88 → 08/90	1.390	B	M	4	8	E6J700, E6J701			81661
	59	01/88 → 12/92	1.390	B	M	4	8	E6J700			81661
	59	01/88 → 12/92	1.390	B	M	4	8	E6J700, E6J701			81661
	43	07/88 → 04/92	1.397	B	M	4	8	C2J772, C3J710		(-)COP	81573
	43	01/89 → 04/92	1.397	B	M	4	8	C2J772, C3J710		(-)COP, 07-1988 →, → 04-1992	81573
1.4	43	01/89 → 04/92	1.397	B	M	4	8	C2J772, C3J710		(+)COP	81811
1.7	55	07/91 → 04/92	1.721	B	M	4	8	F2N724			81574
	70	07/91 → 04/92	1.721	B	M	4	8	F3N742, F3N743			81574
	54	09/88 → 04/92	1.721	B	M	4	8	F3N740, F3N741			81574
	66	09/88 → 04/92	1.721	B	M	4	8	F3N742, F3N743			81574
	79	08/88 → 12/92	1.721	B	M	4	8	F3N746			81574
1.8 16V	99	06/89 → 04/92	1.764	B	M	4	16	F7P704			81574
	101	07/91 → 04/92	1.764	B	M	4	16	F7P700, F7P704			81574
1.9 D	48	01/88 → 12/92	1.870	D	M	4	8	F8Q706, F8Q742			81574
	47	09/88 → 04/92	1.870	D	M	4	8	F8Q706, F8Q742			81574
1.9 DT	68	09/90 → 04/92	1.870	D	M	4	8	F8Q610			81574
1.9 TD	68	09/90 → 04/92	1.870	D	M	4	8	F8Q740			81574
<b>19 II, Chamade, Cabrio</b>											
1.2	44	05/92 → 09/94	1.171	B	M	4	8	E7F730			81661
	40	03/92 → 12/95	1.237	B	M	4	8	C1G730			81661
	40	04/92 → 12/95	1.237	B	M	4	8	C1G730		(-)COP	81573
	40	04/92 → 12/95	1.237	B	M	4	8	C1G730		(+)COP	81811
1.4	59	03/92 → 12/95	1.390	B	M	4	8	E6J700			81661
	59	01/92 → 12/95	1.390	B	M	4	8	E6J700, E7J706			81661
	59	10/94 → 11/95	1.390	B	M	4	8	E7J706			81661
	55	01/92 → 12/95	1.390	B	M	4	8	E7J742			81661
	43	04/92 → 12/95	1.397	B	M	4	8	C3J710		(-)COP	81573
	43	04/92 → 12/95	1.397	B	M	4	8	C3J710		(+)COP	81811
1.7	54	04/92 → 12/95	1.721	B	M	4	8	F3N740, F3N741			81574
	66	04/92 → 09/93	1.721	B	M	4	8	F3N742, F3N743			81574
	66	04/92 → 12/95	1.721	B	M	4	8	F3N743			81574

							NO. OF VALVES		
--	--	--	--	--	--	--	---------------	--	--

## RENAULT

### 19 II, Chamade, Cabrio

1.8	79	05/94 → 12/95	1.783	B	M	4	8	F3P682		81574
	65	04/92 → 06/96	1.794	B	M	4	8	F3P704, F3P705, F3P706, F3P707, F3P708, F3P760		81574
	65	04/92 → 12/95	1.794	B	M	4	8	F3P706, F3P707, F3P708, F3P760		81574
	66	04/92 → 12/95	1.794	B	M	4	8	F3P706, F3P760		81574
	79	07/94 → 06/96	1.794	B	M	4	8	F3P682, F3P764, F3P765		81574
	79	05/94 → 12/95	1.794	B	M	4	8	F3P682, F3P765		81574
	81	04/92 → 05/94	1.794	B	M	4	8	F3P700		81574
1.8 16V	99	04/92 → 12/95	1.764	B	M	4	16	F7P704		81574
1.9 D	48	03/92 → 12/95	1.870	D	M	4	8	F8Q706, F8Q742		81574
	47	04/92 → 12/95	1.870	D	M	4	8	F8Q742		81574
1.9 dT	68	03/92 → 12/95	1.870	D	M	4	8	F8Q740		81574
	66	04/92 → 12/95	1.870	D	M	4	8	F8Q744		81574

### 21, Station Wagon

1.4	51	09/89 → 05/93	1.397	B	M	4	8	C2J770	(-)COP	81573
	51	09/89 → 05/93	1.397	B	M	4	8	C2J770	(+)COP	81811
1.7	65	06/86 → 04/95	1.721	B	M	4	8	F2N710		81574
	54	06/86 → 06/93	1.721	B	M	4	8	F2N750, F3N726		81574
	54	09/89 → 10/92	1.721	B	M	4	8	F3N726		81574
	55	06/86 → 03/93	1.721	B	M	4	8	F2N712		81574
	65	03/86 → 03/93	1.721	B	M	4	8	F2N710		81574
	66	09/89 → 06/94	1.721	B	M	4	8	F3N722, F3N723		81574
	69	03/86 → 02/94	1.721	B	M	4	8	F3N722, F3N723		81574
1.9 D	47	06/86 → 08/94	1.870	D	M	4	8	F8Q710		81574
	47	09/89 → 01/94	1.870	D	M	4	8	F8Q710		81574
2.0	78	05/91 → 10/93	1.995	B	M	4	8	J6R758	→ M: F.197.763	81608
	78	05/91 → 10/93	1.995	B	M	4	8	J6R758	M →: F.197.764	81666
	75	03/86 → 10/93	1.995	B	M	4	8	J6R758, J6R759, J6R792, J6R793	→ M: F.197.763	81608
	75	03/86 → 10/93	1.995	B	M	4	8	J6R758, J6R759, J6R792, J6R793	M →: F.197.764	81666
	88	09/89 → 12/93	1.995	B	M	4	8	J7R746, J7R747	→ M: F.197.763	81608
	88	09/89 → 12/93	1.995	B	M	4	8	J7R746, J7R747	M →: F.197.764	81666
	99	02/90 → 10/92	1.995	B	M	4	12	J7R740	→ M: F.197.763	81608
2.0 4x4	99	02/90 → 10/92	1.995	B	M	4	12	J7R740	M →: F.197.764	81666
	88	03/89 → 12/93	1.995	B	M	4	8	J7R746, J7R747	→ M: F.197.763	81608
	88	03/89 → 12/93	1.995	B	M	4	8	J7R746, J7R747	M →: F.197.764	81666
	99	09/90 → 10/92	1.995	B	M	4	12	J7R740	→ M: F.197.763	81608
2.0 Turbo	99	09/90 → 10/92	1.995	B	M	4	12	J7R740	M →: F.197.764	81666
	119	02/90 → 10/92	1.995	B	M	4	8	J7R756	M →: F.209.863	81754
	129	04/87 → 03/90	1.995	B	M	4	8	J7R752	M →: F.209.863	81754

**KW**

**cm<sup>3</sup>**

**NO. OF  
VALVES**

**MAGNETI  
MARELLI**
**RENAULT**
**21, Station Wagon**

2.0 Turbo 4x4	129	08/89 → 10/93	1.995	B	M	4	8	J7R752	M →: F.209.863	81754
	119	02/90 → 10/92	1.995	B	M	4	8	J7R756	M →: F.209.863	81754
2.1 D	49	06/86 → 08/94	2.068	D	M	4	8	J8S704		81608
	48	10/86 → 09/90	2.068	D	M	4	8	J8S704		81608
	51	04/92 → 06/94	2.068	D	M	4	8	J8S784		81608
	53	09/89 → 12/92	2.068	D	M	4	8	J8S600, J8S740		81608
2.1 D 4x4	48	10/88 → 05/92	2.068	D	M	4	8	J8S704		81608
2.1 Turbo-D	65	09/89 → 06/94	2.068	D	M	4	8	J8S714, J8S786, J8S788		81608
2.2	79	09/89 → 06/94	2.165	B	M	4	8	J7T754, J7T755	→ M: F241.442	81608
	79	09/89 → 06/94	2.165	B	M	4	8	J7T754, J7T755	M →: F241.443	81666
2.2 4x4	79	07/90 → 06/94	2.165	B	M	4	8	J7T754, J7T755	→ M: F241.442	81608
	79	07/90 → 06/94	2.165	B	M	4	8	J7T754, J7T755	M →: F241.443	81666

**25**

2.0	88	03/87 → 12/93	1.995	B	M	4	8	J7R722, J7R723		81666
	74	04/84 → 12/92	1.995	B	M	4	8	J6R706, J6R707, J6R760, J6R762, J6R763	→ M: F.308.131	81828
	74	04/84 → 12/92	1.995	B	M	4	8	J6R706, J6R707, J6R760, J6R762, J6R763	M →: F.308.132	81754
2.0 12V	103	06/88 → 12/93	1.995	B	M	4	12	J7R720, J7R721		81666
	99	06/89 → 12/92	1.995	B	M	4	12	J7R726		81666
2.1 Diesel	51	06/89 → 12/92	2.068	D	M	4	8	J8S736		81851
2.1 Turbo-D FWD	63	04/84 → 12/92	2.068	D	M	4	8	J8S708, J8S738	M →: F.397.290	81755
2.2	79	09/86 → 12/92	2.165	B	M	4	8	J7T708, J7T732, J7T733		81666

**Avantime**

2.0 16V Turbo	120	11/01 → 05/03	1.998	B	M	4	16	F4R760, F4R761		81814
	120	11/01 → 05/03	1.998	B	M	4	16	F4R760, F4R761		84009
2.2 dCi	110	05/02 → 05/03	2.188	D	M	4	16	G9T712		81855
3.0 V6	152	09/01 → 05/03	2.946	B	AM	6	24	L7X720, L7X721		81813

**Captur**

0.9 TCe 90	66	06/13 →	898	B	M	3	12	H4B400		84003
1.2 TCe 120	88	06/13 →	1.197	B	M	4	16	H5F403		84003
1.5 dCi 110	81	01/15 →	1.461	D	M	4	8	K9K646		82098



**KW**

**cm<sup>3</sup>**

**NO. OF VALVES**

**MAGNETI MARELLI**
**RENAULT**
**Clio I**

1.1	34	01/91 → 09/98	1.108	B	M	4	8	C1E700	(-)COP	81573
	34	01/91 → 09/98	1.108	B	M	4	8	C1E700	(-)COP, → 05-1994, M: C1E700	81573
	34	01/91 → 09/98	1.108	B	M	4	8	C1E700	(+)COP	81811
	34	01/91 → 09/98	1.108	B	M	4	8	C1E700	(+)COP, → 05-1994, M: C1E700	81811
	36	04/92 → 08/92	1.108	B	M	4	8	C1E700	(-)COP, → 05-1994, M: C1E700	81573
	36	04/92 → 08/92	1.108	B	M	4	8	C1E700	(+)COP, → 05-1994, M: C1E700	81811
1.2	40	01/91 → 09/98	1.171	B	M	4	8	E7F706		81661
	44	01/91 → 09/98	1.171	B	M	4	8	E7F750		81661
	40	06/94 → 02/98	1.239	B	M	4	8	C3G720	(-)COP	81596
	40	06/94 → 02/98	1.239	B	M	4	8	C3G720	(+)COP	81854
	40	01/96 → 09/98	1.149	B	M	4	8	D7F730		81762
	43	01/96 → 09/98	1.149	B	M	4	8	D7F730		81762
	40	01/91 → 06/96	1.171	B	M	4	8	E7F706		81661
	43	05/90 → 09/98	1.171	B	M	4	8	E7F700, E7F708, E7F750		81661
	44	05/90 → 03/96	1.171	B	M	4	8	E5F710		81661
	40	01/96 → 12/96	1.239	B	M	4	8	C3G720	(-)COP	81596
1.4	59	01/91 → 09/98	1.390	B	M	4	8	E7J710, E7J711		81661
	55	01/91 → 09/98	1.390	B	M	4	8	E7J756, E7J757		81661
	58	01/91 → 09/98	1.390	B	M	4	8	E7J601, E7J718, E7J719, E7J754		81661
1.7	68	01/91 → 12/93	1.721	B	M	4	8	F2N770		81574
1.8	70	01/91 → 09/98	1.794	B	M	4	8	F3P710		81574
	65	01/91 → 09/98	1.794	B	M	4	8	F3P710, F3P714		81574
	66	08/94 → 09/98	1.794	B	M	4	8	F3P754, F3P755		81574
1.8 16V	99	01/91 → 03/96	1.764	B	M	4	16	F7P722		81574
1.8 Rsi	79	08/95 → 09/98	1.783	B	M	4	8	F3P758		81574
	80	01/93 → 08/95	1.794	B	M	4	8	F3P712		81574
1.9 D	40	01/97 → 09/98	1.870	D	M	4	8	F8Q678		81574
	48	01/91 → 09/98	1.870	D	M	4	8	F8Q730, F8Q732		81574
	47	01/91 → 09/98	1.870	D	M	4	8	F8Q730, F8Q732		81574
1.9 RND	40	04/96 → 02/98	1.870	D	M	4	8	F8Q678		81574
Williams	108	01/94 → 09/98	1.998	B	M	4	16	F7R700		81574
<b>Clio II</b>										
1.1	43	09/98 →	1.149	B	M	4	8	D7F720, D7F726, D7F746		81762

	<b>KW</b>		<b>cm<sup>3</sup></b>				<b>NO. OF VALVES</b>			<b>MAGNETI MARELLI</b>
--	-----------	--	-----------------------	--	--	--	----------------------	--	--	------------------------

**RENAULT**
**Clio II**

1.2	55	06/01 →	1.149	B	M	4	8			81762
	43	09/98 →	1.149	B	M	4	8	D7F720, D7F726, D7F746, D7F764, D7F766	→ 12-2003	81762
	43	09/98 →	1.149	B	M	4	8	D7F720, D7F726, D7F746, D7F764, D7F766	01-2004 →	82091
	44	03/99 → 05/01	1.149	B	M	4	8	D7F722		81762
	44	03/99 → 10/03	1.149	B	M	4	8	D7F722, D7F726, D7F746		81762
1.2 16V	55	06/01 →	1.149	B	M	4	16	D4F706, D4F712, D4F714, D4F722, D4F728	→ 05-2003	81820
	55	06/01 →	1.149	B	M	4	16	D4F706, D4F712, D4F714, D4F722, D4F728	06-2003 →	82090
1.4	55	09/98 → 05/05	1.390	B	M	4	8	E7J634, E7J780, K7J700		81578
1.4 16V	70	10/99 → 09/04	1.390	B	M	4	16	K4J712, K4J713		84039 <b>NEW</b>
	70	10/99 → 09/04	1.390	B	M	4	16	K4J712, K4J713		81806
	72	08/00 →	1.390	B	M	4	16	K4J710, K4J711, K4J712, K4J713		84039 <b>NEW</b>
	72	08/00 →	1.390	B	M	4	16	K4J710, K4J711, K4J712, K4J713		81806
1.5 dCi	50	04/04 →	1.461	D	M	4	8	K9K714		81810
	59	06/01 → 10/04	1.461	D	M	4	8	K9K702		81810
	60	11/03 →	1.461	D	M	4	8	K9K702, K9K710, K9K716		81810
	74	01/04 →	1.461	D	M	4	8	K9K712		84007
	47	06/05 →	1.461	D	M	4	8	K9K740		84007
	48	06/01 →	1.461	D	M	4	8	K9K700, K9K704		81810
	50	08/04 →	1.461	D	M	4	8	K9K700, K9K714		84007
	59	06/01 → 10/03	1.461	D	M	4	8	K9K702		81810
	60	06/01 →	1.461	D	M	4	8	K9K702		81810
1.6	62	02/07 →	1.461	D	M	4	8	K9K718		84007
	66	09/98 → 05/05	1.598	B	M	4	8	K7M744, K7M745		81579
1.6 16V	79	09/98 →	1.598	B	M	4	16	K4M708, K4M740, K4M742, K4M743, K4M744, K4M745, K4M748		84039 <b>NEW</b>
	79	09/98 →	1.598	B	M	4	16	K4M708, K4M740, K4M742, K4M743, K4M744, K4M745, K4M748		81806

--	--	--	--	--	--	--	--	--	--

## RENAULT

### Clio II

1.6 Hi-Flex	86	01/05 → 02/10	1.598		M	4	16	K4M748		84039	<b>NEW</b>
	86	01/05 → 02/10	1.598		M	4	16	K4M748		81806	
1.9 D	47	09/98 → 05/05	1.870	D	M	4	8	F8Q630		81574	
	48	02/00 → 05/01	1.870	D	M	4	8	F8Q630, F8Q632		81574	
	48	02/00 → 05/01	1.870	D	M	4	8	F8Q632		81574	
1.9 dTi	59	12/99 → 05/05	1.870	D	M	4	8	F9Q780		81574	
2.0 16V Sport	132	01/04 →	1.998	B	M	4	16	F4R738		81574	
	124	02/00 →	1.998	B	M	4	16	F4R730, F4R736		81574	
3.0 V6 Sport	166	11/00 → 12/02	2.946	B	M	6	24	L7X760		81813	
	187	12/02 →	2.946	B	M	6	24	L7X762		81813	

### Clio III, Grandtour

1.2	57	10/05 →	1.149	B	M	4	16	D4F764		82090	
1.2 16V	58	06/05 →	1.149	B	M	4	16	D4F764		82090	
	76	09/10 →	1.149	B	M	4	16	D4F786		81820	
	76	09/10 →	1.149	B	M	4	16	D4F786		82090	
	76	09/10 →	1.149	B	M	4	16	D4F786		84024	<b>NEW</b>
	76	09/10 →	1.149	B	M	4	16	D4F786		81762	
	48	06/05 →	1.149	B	M	4	16	D4F740		82090	
	55	06/05 →	1.149	B	M	4	16	D4F706, D4F740		82090	
	55	02/08 →	1.149	B	M	4	16	D4F740		82090	
	58	02/08 →	1.149	B	M	4	16	D4F764		82090	
	74	02/08 →	1.149	B	M	4	16	D4F784		82090	
1.2 16V Hi-Flex	55	07/08 →	1.149		M	4	16	D4F740		82090	
	55	07/08 →	1.149		M	4	16	D4F740, D4F742		82090	
1.2 Ethanol	55	07/08 →	1.149		M	4	16			81820	
	55	07/08 →	1.149		M	4	16			82090	
	55	07/08 →	1.149		M	4	16			84024	<b>NEW</b>
	55	07/08 →	1.149		M	4	16			81762	
1.4 16V	72	02/10 →	1.390	B	M	4	16	K4J780		84039	<b>NEW</b>
	72	02/10 →	1.390	B	M	4	16	K4J780		81806	
1.5 dCi	47	06/05 →	1.461	D	M	4	8	K9K752		84007	
	48	02/10 →	1.461	D	M	4	8	K9K752		84007	
	55	08/10 →	1.461	D	M	4	8	K9K770		82098	
	60	11/07 →	1.461	D	M	4	8	K9K750		84007	
	65	08/10 →	1.461	D	M	4	8	K9K770		82098	
	65	08/10 →	1.461	D	M	4	8	K9K770, K9K772		82098	
	50	02/08 →	1.461	D	M	4	8	K9K714, K9K768		84007	
	63	02/08 →	1.461	D	M	4	8	K9K766		84007	
	76	02/08 →	1.461	D	M	4	8	K9K772		84007	
78	02/08 →	1.461	D	M	4	8	K9K764, K9K774		84007		

**KW**

**cm<sup>3</sup>**

**NO. OF VALVES**

**MAGNETI MARELLI**
**RENAULT**
**Clio III, Grandtour**

1.6 16V	65	06/05 →	1.598	B	M	4	16	K4M804		84039	<b>NEW</b>
	65	06/05 →	1.598	B	M	4	16	K4M804		81806	
	82	02/08 →	1.598	B	M	4	16	K4M800, K4M801		84039	<b>NEW</b>
	82	02/08 →	1.598	B	M	4	16	K4M800, K4M801		81806	
	94	11/08 →	1.598	B	M	4	16	K4M862		84039	<b>NEW</b>
	94	11/08 →	1.598	B	M	4	16	K4M862		81806	
1.6 16V GT	94	06/09 →	1.598	B	M	4	16	K4M862		84039	<b>NEW</b>
	94	06/09 →	1.598	B	M	4	16	K4M862		81806	
1.6 Hi-Flex	86	05/05 → 02/10	1.598		M	4	16	K4M748		84039	<b>NEW</b>
	86	05/05 → 02/10	1.598		M	4	16	K4M748		81806	
2.0 16V Sport	145	02/06 →	1.998	B	M	4	16	F4R830		81814	
	145	02/06 →	1.998	B	M	4	16	F4R830		84009	
	148	09/08 →	1.998	B	M	4	16	F4R830		81814	
	148	09/08 →	1.998	B	M	4	16	F4R830		84009	

**Clio IV, Grandtour**

0.9 TCe 90	66	01/13 →	898	B	M	3	12	H4B400		84003	
1.2 16V	54	11/12 →	1.149	B	M	4	16	D4F728, D4F740		81820	
	54	11/12 →	1.149	B	M	4	16	D4F728, D4F740		82090	
	54	11/12 →	1.149	B	M	4	16	D4F728, D4F740		84024	<b>NEW</b>
	54	11/12 →	1.149	B	M	4	16	D4F728, D4F740		81762	
	54	01/13 →	1.149	B	M	4	16	D4F740		81820	
	54	01/13 →	1.149	B	M	4	16	D4F740		82090	
	54	01/13 →	1.149	B	M	4	16	D4F740		84024	<b>NEW</b>
	54	01/13 →	1.149	B	M	4	16	D4F740		81762	
1.2 TCe 120	88	03/13 →	1.197	B	M	4	16	H5F403		84003	
1.5 dCi 75	55	01/13 →	1.461	D	M	4	8	K9K612		82098	
1.5 dCi 90	66	01/13 →	1.461	D	M	4	8	K9K608		82098	

**Duster**

1.6 16V	75	02/12 →	1.598	B	M	4	16	K4M616		84039	<b>NEW</b>
	75	02/12 →	1.598	B	M	4	16	K4M616		81806	
2.0	98	02/12 →	1.998	B	M	4	16	F4R403, F4R405		81814	
	98	02/12 →	1.998	B	M	4	16	F4R403, F4R405		84009	

**Espace I**

2.0	74	01/88 → 12/90	1.995	B	M	4	8	J6R734		81576	
	80	07/84 → 12/90	1.995	B	M	4	8	J6R234, J6R236		81576	
2.0 i	87	01/89 → 12/90	1.995	B	M	4	8	J7R760		81576	
2.0 i Quadra	87	03/88 → 12/92	1.995	B	M	4	8	J7R760		81576	
2.1 TD	65	10/84 → 12/90	2.068	D	M	4	8	J8S240, J8S774, J8S776		81576	
2.2	79	07/86 → 12/90	2.165	B	M	4	8	J7T770		81576	
2.2 Quadra	79	01/88 → 12/90	2.165	B	M	4	8	J7T770		81576	

		<b>KW</b>		<b>cm<sup>3</sup></b>				<b>NO. OF VALVES</b>		
--	--	-----------	--	-----------------------	--	--	--	----------------------	--	--

## RENAULT

### Espace II

2.0	76	01/91 → 10/96	1.995	B	M	4	8	J7R768		81666
2.1 RTDT Quadra	65	01/91 → 05/92	2.068	D	M	4	8	J8S772		81667
2.1 TD	65	01/91 → 10/96	2.068	D	M	4	8	J8S610, J8S772, J8S776, J8S778		81667
	66	11/94 → 10/96	2.068	D	M	4	8	J8S612		81667
2.2	79	01/91 → 10/96	2.165	B	M	4	8	J7T772, J7T773, J7T776		81666
2.2 4x4	79	03/91 → 12/96	2.165	B	M	4	8	J7T772, J7T773		81666

### Espace III

1.9 dTi	72	02/99 → 10/02	1.870	D	M	4	8	F9Q722		81574
2.0	102	09/01 → 10/02	1.998	B	M	4	16	F4R700, F4R701		81574
	84	11/96 → 10/00	1.998	B	M	4	8	F3R728, F3R729, F3R742, F3R768, F3R769		81574
2.0 16V	103	10/98 → 10/02	1.998	B	M	4	16	F4R700, F4R701		81574
2.2 12V TD	83	11/96 → 10/00	2.188	D	M	4	12	G8T714, G8T716, G8T760		81761
2.2 D	84	11/97 → 01/00	2.188	D	M	4	12	G8T716		81761
2.2 dCi	85	07/00 → 10/02	2.188	D	M	4	16	G9T710		81855
	95	10/00 → 10/02	2.188	D	M	4	16	G9T642, G9T710		81855
3.0 V6 24V	140	10/98 → 10/02	2.946	B	M	6	24	L7X727	→ T: 08441	81844
	140	10/98 → 10/02	2.946	B	M	6	24	L7X727	T →: 08442	82042

### Espace IV

1.9 dCi	85	04/03 → 02/05	1.870	D	M	4	8	F9Q820		81814
	85	04/03 → 02/05	1.870	D	M	4	8	F9Q820		84009
	88	11/02 →	1.870	D	M	4	8	F9Q680, F9Q820, F9Q826		81814
	88	11/02 →	1.870	D	M	4	8	F9Q680, F9Q820, F9Q826		84009
2.0	98	11/02 → 02/05	1.998	B	M	4	16	F4R790		81814
	98	11/02 → 02/05	1.998	B	M	4	16	F4R790		84009
	100	11/02 →	1.998	B	M	4	16	F4R792		81814
	100	11/02 →	1.998	B	M	4	16	F4R792		84009
	125	04/05 →	1.998	B	M	4	16	F4R796, F4R797, F4R896, F4R897		81814
	125	04/05 →	1.998	B	M	4	16	F4R796, F4R797, F4R896, F4R897		84009
2.0 dCi	96	01/06 →	1.995	D	M	4	16	M9R740, M9R750, M9R760, M9R761, M9R762, M9R763		82069
	110	01/06 →	1.995	D	M	4	16	M9R740, M9R750, M9R815		82069
	127	01/06 →	1.995	D	M	4	16	M9R760, M9R761, M9R762, M9R763, M9R815		82069

**KW**

**cm<sup>3</sup>**

**NO. OF VALVES**

**MAGNETI MARELLI**
**RENAULT**
**Espace IV**

2.0 Turbo	120	11/02 →	1.998	B	AM	4	16	F4R794, F4R795, F4R796, F4R797		81814
	120	11/02 →	1.998	B	AM	4	16	F4R794, F4R795, F4R796, F4R797		84009
2.2 dCi	102	02/06 →	2.188	D	M	4	16	G9T645		81855
	110	11/02 →	2.188	D	M	4	16	G9T742, G9T743		81855

**Espace V**

1.6 dCi 130	96	06/15 →	1.598	D	M	4	16	R9M409		84034	<b>NEW</b>
1.6 dCi 160	118	06/15 →	1.598	D	M	4	16	R9M452		84034	<b>NEW</b>

**Fluence**

1.5 dCi	63	02/10 →	1.461	D	M	4	8	K9K830		84007	
	66	02/10 →	1.461	D	M	4	8	K9K834		82098	
	78	02/10 →	1.461	D	M	4	8	K9K832		84007	
	81	02/10 →	1.461	D	M	4	8	K9K836, K9K837		82098	
1.6 16V	82	02/10 →	1.598	B	M	4	16	K4M838		84039	<b>NEW</b>
	82	02/10 →	1.598	B	M	4	16	K4M838		81806	
	81	02/10 →	1.598	B	M	4	16	K4M838, K4M839		84039	<b>NEW</b>
	81	02/10 →	1.598	B	M	4	16	K4M838, K4M839		81806	

**Grand Scénic II**

1.5 dCi	74	04/04 →	1.461	D	M	4	8	K9K728		81810	
	78	05/05 →	1.461	D	M	4	8	K9KP732		81810	
1.6	77	06/06 →	1.598	B	M	4	16	K4M788		84039	<b>NEW</b>
	77	06/06 →	1.598	B	M	4	16	K4M788		81806	
	82	06/06 → 11/08	1.598	B	M	4	16	K4M812		84039	<b>NEW</b>
	82	06/06 → 11/08	1.598	B	M	4	16	K4M812		81806	
	83	04/04 →	1.598	B	M	4	16	K4M761, K4M782		84039	<b>NEW</b>
	83	04/04 →	1.598	B	M	4	16	K4M761, K4M782		81806	
1.9 dCi	85	05/05 → 01/09	1.870	D	M	4	8	F9Q803, F9Q804, F9Q812		81868	
	85	05/05 → 01/09	1.870	D	M	4	8	F9Q803, F9Q804, F9Q812		84006	
	81	05/05 →	1.870	D	M	4	8	F9QE804		81868	
	81	05/05 →	1.870	D	M	4	8	F9QE804		84006	
	88	04/04 →	1.870	D	M	4	8	F9Q812		81868	
	88	04/04 →	1.870	D	M	4	8	F9Q812		84006	
	96	05/05 →	1.870	D	M	4	8	F9Q816, F9Q818, F9QEE804, F9QJ803		81868	
96	05/05 →	1.870	D	M	4	8	F9Q816, F9Q818, F9QEE804, F9QJ803		84006		
2.0	99	04/04 →	1.998	B	M	4	16	F4R770, F4R771		81814	
	99	04/04 →	1.998	B	M	4	16	F4R770, F4R771		84009	
	120	04/04 →	1.998	B	M	4	16	F4R776		81814	
	120	04/04 →	1.998	B	M	4	16	F4R776		84009	

--	--	--	--	--	--	--	--	--	--

## RENAULT

### Grand Scénic II

2.0 dCi	110	09/05 →	1.995	D	M	4	16	M9R700, M9R721, M9R722		82069
---------	-----	---------	-------	---	---	---	----	------------------------	--	-------

### Grand Scénic III

1.2 TCe	97	01/13 →	1.197	B	M	4	16	H5F404		84003
1.4 16V	96	02/09 →	1.397	B	M	4	16	H4J700		84003
1.5 dCi	63	04/09 →	1.461	D	M	4	8	K9K830		84007
	70	11/10 →	1.461	D	M	4	8	K9K846		82098
	78	02/09 →	1.461	D	M	4	8	K9K832		84007
	81	04/09 →	1.461	D	M	4	8	K9K636, K9K836, K9K837		82098
1.6 16V	81	02/09 →	1.598	B	M	4	16	K4M858		84039 <b>NEW</b>
	81	02/09 →	1.598	B	M	4	16	K4M858		81806
1.6 16V Bifuel	81	02/09 →	1.598	BF	M	4	16	K4M866		84039 <b>NEW</b>
	81	02/09 →	1.598	BF	M	4	16	K4M866		81806
1.6 dCi	96	04/11 →	1.598	D	M	4	16	R9M402, R9M404		84034 <b>NEW</b>
1.9 dCi	96	02/09 →	1.870	D	M	4	8	F9Q870, F9Q872		82099
2.0 dCi	110	02/09 →	1.995	D	M	4	16	M9R615		82069
	118	04/09 →	1.995	D	M	4	16	M9R610		82069

### Kadjar

1.2 TCe 130	96	06/15 →	1.197	B	M	4	16	H5F408		84003
1.5 dCi 110	81	06/15 →	1.461	D	M	4	8	K9K646, K9K647		82098
1.6 dCi 130	96	06/15 →	1.598	D	M	4	16	R9M414		84034 <b>NEW</b>
1.6 dCi 130 4x4	96	06/15 →	1.598	D	M	4	16	R9M414		84034 <b>NEW</b>

### Kangoo I, Van

1.2	43	08/97 →	1.149	B	M	4	8	D7F710, D7F720, D7F722, D7F726, D7F744, D7F746		81762
	44	07/98 → 07/01	1.149	B	M	4	8	D7F764, D7F766		81762
1.2 16V	55	06/01 →	1.149	B	M	4	16	D4F712, D4F714, D4F716, D4F730		81820
	55	10/01 →	1.149	B	M	4	16	D4F712, D4F714, D4F730		81820
1.2 BiFuel	43	07/98 → 07/01	1.149	BF	M	4	8	D7F710, D7F744		82091
	43	07/98 → 07/01	1.149	BF	M	4	8	D7F710, D7F744		81762
1.4	55	08/97 →	1.390	B	M	4	8	E7J634, E7J635, E7J780, K7J700, K7J701	M: E7J 634, M: E7J 780, M: E7J 635, M: E7J 634	81578
	55	08/97 →	1.390	B	M	4	8	E7J634, E7J635, E7J780, K7J700, K7J701	M: K7J 701, M: K7J 700	81579
	55	08/97 →	1.390	B	M	4	8	E7J634, E7J635, E7J780, K7J701	M: E7J 634, M: E7J 780, M: E7J 635, M: E7J 634	81578
	55	08/97 →	1.390	B	M	4	8	E7J634, E7J635, E7J780, K7J701	M: K7J 701, M: K7J 700	81579

**KW**

**cm³**

**NO. OF  
VALVES**

**MAGNETI  
MARELLI**
**RENAULT**
**Kangoo I, Van**

1.5 dCi	42	07/03 →	1.461	D	M	4	8	K9K704	→ 03-2004	81810
	42	07/03 →	1.461	D	M	4	8	K9K704	04-2004 →	84007
	45	04/05 → 06/10	1.461	D	M	4	8	K9K700, K9K702		81810
	45	04/05 → 06/10	1.461	D	M	4	8	K9K700, K9K702		84007
	45	10/05 →	1.461	D	M	4	8	K9K716		81810
	50	06/05 →	1.461	D	M	4	8	K9K714		81810
	62	06/05 →	1.461	D	M	4	8	K9K718		84007
	42	12/02 →	1.461	D	M	4	8	K9K704	→ 03-2004	81810
	42	12/02 →	1.461	D	M	4	8	K9K704	04-2004 →	84007
	48	12/01 →	1.461	D	M	4	8	K9K700, K9K702, K9K704	→ 03-2004	81810
	48	12/01 →	1.461	D	M	4	8	K9K700, K9K702, K9K704	04-2004 →	84007
	48	12/01 →	1.461	D	M	4	8	K9K700, K9K704	→ 03-2004	81810
	48	12/01 →	1.461	D	M	4	8	K9K700, K9K704	04-2004 →	84007
	50	06/05 →	1.461	D	M	4	8	K9K714		81810
	60	07/02 →	1.461	D	M	4	8	K9K702, K9K710	→ 03-2004	81810
	60	07/02 →	1.461	D	M	4	8	K9K702, K9K710	04-2004 →	84007
	62	06/05 →	1.461	D	M	4	8	K9K718		81810
	1.6	66	09/99 → 06/01	1.598	B	M	4	8	K7M746	
1.6 16V	70	06/01 →	1.598	B	M	4	16	K4M706, K4M750, K4M752, K4M753		84039 <b>NEW</b>
	70	06/01 →	1.598	B	M	4	16	K4M706, K4M750, K4M752, K4M753		81806
	70	10/01 →	1.598	B	M	4	16	K4M706, K4M752		84039 <b>NEW</b>
	70	10/01 →	1.598	B	M	4	16	K4M706, K4M752		81806
1.6 16V 4x4	70	10/01 →	1.598	B	M	4	16	K4M750, K4M752, K4M753		84039 <b>NEW</b>
	70	10/01 →	1.598	B	M	4	16	K4M750, K4M752, K4M753		81806
1.6 16V bivalent	60	06/05 →	1.598		M	4	16	K4M850		84039 <b>NEW</b>
	60	06/05 →	1.598		M	4	16	K4M850		81806
1.9 D	48	09/99 → 06/03	1.870	D	M	4	8	F8Q632		81574
1.9 dCi	62	07/03 →	1.870	D	M	4	8	F9Q782, F9Q790		81574
1.9 dCi 4x4	62	10/03 →	1.870	D	M	4	8	F9Q790		81574
	59	10/01 →	1.870	D	M	4	8	F9Q782, F9Q790		81574
	62	07/03 →	1.870	D	M	4	8	F9Q790		81574
1.9 dTi	59	02/00 →	1.870	D	M	4	8	F9Q780		81574
	59	02/00 →	1.870	D	M	4	8	F9Q780, F9Q782		81574
1.9 RXED	48	09/99 → 06/01	1.870	D	M	4	8	F8Q630, F8Q632		81574
D 55 1.9	40	08/97 →	1.870	D	M	4	8	F8Q662		81574
D 65 1.9	47	08/97 →	1.870	D	M	4	8	F8Q630, F8Q632		81574



	KW		cm <sup>3</sup>				NO. OF VALVES		
--	----	--	-----------------	--	--	--	---------------	--	--

## RENAULT

### Kangoo II, Be Bop, Van

1.2 TCe 115	84	07/13 →	1.197	B	M	4	16	H5F400		84003
1.5 dCi	50	02/08 →	1.461	D	M	4	8	K9K800		84007
	66	11/12 →	1.461	D	M	4	8	K9K808		82098
	80	06/09 →	1.461	D	M	4	8	K9K804		82098
	50	02/08 →	1.461	D	M	4	8	K9K714, K9K800, K9K840		84007
	63	02/08 →	1.461	D	M	4	8	K9K802		84007
	66	06/09 →	1.461	D	M	4	8	K9K808		82098
	76	02/08 →	1.461	D	M	4	8	K9K804, K9K806		84007
	76	02/09 →	1.461	D	M	4	8	K9K806		84007
1.5 dCi 110	80	09/10 →	1.461	D	M	4	8	K9K804		84007
	80	09/10 →	1.461	D	M	4	8	K9K804		82098
	81	03/13 →	1.461	D	M	4	8	K9K636		82098
1.5 dCi 75	55	09/10 →	1.461	D	M	4	8	K9K608, K9K808		82098
	55	09/10 →	1.461	D	M	4	8	K9K802		82098
1.5 dCi 85	63	02/08 →	1.461	D	M	4	8	K9K800, K9K802		84007
1.5 dCi 90	66	06/09 →	1.461	D	M	4	8	K9K608, K9K808		82098
1.6	64	02/08 →	1.598	B	M	4	8	K7M750		81579
	64	02/08 →	1.598	B	M	4	8	K7M750		81579
	78	02/09 →	1.598	B	M	4	16	K4M830		84039 <b>NEW</b>
	78	02/09 →	1.598	B	M	4	16	K4M830		81806
1.6 16V	78	02/08 →	1.598	B	M	4	16	K4M830		84039 <b>NEW</b>
	78	02/08 →	1.598	B	M	4	16	K4M830		81806
	78	02/08 →	1.598	B	M	4	16	K4M830, K4M831		84039 <b>NEW</b>
	78	02/08 →	1.598	B	M	4	16	K4M830, K4M831		81806
1.6 16V Hi-Flex	78	02/08 →	1.598		M	4	16	K4M834, K4M850		84039 <b>NEW</b>
	78	02/08 →	1.598		M	4	16	K4M834, K4M850		81806
1.6 16V LPG	72	02/08 →	1.598		M	4	16	K4M834		84039 <b>NEW</b>
	72	02/08 →	1.598		M	4	16	K4M834		81806

### Koleos

2.0 dCi	110	09/08 →	1.995	D	M	4	16	M9R855, M9R856, M9R862, M9R865, M9R866		82069
	130	09/08 →	1.995	D	M	4	16	M9R830		82069
2.0 dCi 4x4	110	09/08 →	1.995	D	M	4	16	M9R832, M9R855, M9R856, M9R862, M9R865, M9R866		82069
	127	09/08 →	1.995	D	M	4	16	M9R830		82069
2.5	126	09/08 →	2.488	B	M	4	16	2TR700, 2TR702, 2TR703		84061 <b>NEW</b>
2.5 4x4	126	09/08 →	2.488	B	M	4	16	2TR700, 2TR702, 2TR703		84061 <b>NEW</b>



## RENAULT

### Laguna I, Grantour

1.6 16V	79	11/97 → 03/01	1.598	B	M	4	16	K4M720, K4M724		84039	<b>NEW</b>
	79	11/97 → 03/01	1.598	B	M	4	16	K4M720, K4M724		81806	
1.8	69	06/95 → 02/01	1.783	B	M	4	8	F3P674		81574	
	70	06/95 → 06/98	1.794	B	M	4	8	F3P676		81574	
	66	08/95 → 03/01	1.783	B	M	4	8	F3P670, F3P678		81574	
	66	11/93 → 03/01	1.794	B	M	4	8	F3P720, F3P724		81574	
	69	08/95 → 03/01	1.794	B	M	4	8	F3P720, F3P724		81574	
1.8 16V	88	04/98 → 03/01	1.783	B	M	4	16	F4P760		81574	
	88	04/98 → 03/01	1.783	B	M	4	16	F4P760, F4P770		81574	
1.9 dCi	79	09/99 → 03/01	1.870	D	M	4	8	F9Q718		81814	
	79	09/99 → 03/01	1.870	D	M	4	8	F9Q718		84009	
1.9 dTi	72	10/97 → 03/01	1.870	D	M	4	8	F9Q710, F9Q716, F9Q717		81574	
2.0	103	06/95 → 02/01	1.948	B	M	4	16	N7Q700, N7Q704		82056	
	70	11/93 → 03/01	1.994	B	M	4	8			81574	
	80	03/99 → 03/01	1.998	B	A	4	8	F3R611		81574	
	84	06/95 → 02/01	1.998	B	M	4	8	F3R722, F3R768		81574	
	84	10/98 → 01/01	1.998	B	M	4	8	F3R728, F3R768		81574	
	83	11/93 → 03/01	1.998	B	M	4	8	F3R722, F3R723		81574	
2.0 16V	102	09/99 → 02/01	1.998	B	M	4	16	F4R780		81574	
	102	06/95 → 03/01	1.948	B	M	4	16	N7Q700, N7Q704		82056	
	103	09/99 → 03/01	1.998	B	M	4	16	F4R780		81814	
	103	09/99 → 03/01	1.998	B	M	4	16	F4R780		84009	
2.2 D	61	11/93 → 03/01	2.188	D	M	4	12	G8T706, G8T752, G8T790, G8T794		81760	
2.2 dT	83	03/96 → 03/01	2.188	D	M	4	12	G8T760		81761	
3.0 24V	140	03/97 → 03/01	2.946	B	M	6	24	L7X700, L7X701	→ T: 08441	81844	
	140	03/97 → 03/01	2.946	B	M	6	24	L7X700, L7X701	T →: 08442	82042	

### Laguna II, Grantour

1.6 16V	82	02/05 →	1.598	B	M	4	16	K4M716		84039	<b>NEW</b>
	82	02/05 →	1.598	B	M	4	16	K4M716		81806	
	79	03/01 →	1.598	B	M	4	16	K4M710, K4M714		84039	<b>NEW</b>
	79	03/01 →	1.598	B	M	4	16	K4M710, K4M714		81806	
	82	02/05 →	1.598	B	M	4	16	K4M716		84039	<b>NEW</b>
	82	02/05 →	1.598	B	M	4	16	K4M716		81806	
1.6 FlexFuel	76	06/01 → 10/03	1.598		M	4	16	K4M718		84039	<b>NEW</b>
	76	06/01 → 10/03	1.598		M	4	16	K4M718		81806	



KW



cm<sup>3</sup>



NO. OF VALVES



**RENAULT**

**Laguna II, Grantour**

1.8 16V	86	03/01 →	1.783	B	M	4	16	F4P770		81814
	86	03/01 →	1.783	B	M	4	16	F4P770		84009
	89	03/01 →	1.783	B	M	4	16	F4P770, F4P774		81814
	89	03/01 →	1.783	B	M	4	16	F4P770, F4P774		84009
	85	03/01 →	1.783	B	A	4	16	F4P770, F4P771, F4P773, F4P774, F4P775	M: F4P 775	81806
	85	03/01 →	1.783	B	A	4	16	F4P770, F4P771, F4P773, F4P774, F4P775		81814
	85	03/01 →	1.783	B	A	4	16	F4P770, F4P771, F4P773, F4P774, F4P775		84009
	85	03/01 →	1.783	B	A	4	16	F4P770, F4P771, F4P773, F4P774, F4P775		84039
	85	03/01 →	1.783	B	A	4	16	F4P770, F4P771, F4P774, F4P775		81814
	85	03/01 →	1.783	B	A	4	16	F4P770, F4P771, F4P774, F4P775		84009
	86	03/01 →	1.783	B	M	4	16	F4P770, F4P774		81814
	86	03/01 →	1.783	B	M	4	16	F4P770, F4P774		84009
	88	03/01 →	1.783	B	M	4	16	F4P770, F4P773		81814
	88	03/01 →	1.783	B	M	4	16	F4P770, F4P773		84009
	89	03/01 →	1.783	B	AM	4	16	F4P770, F4P772		81814
	89	03/01 →	1.783	B	AM	4	16	F4P770, F4P772		84009

**KW**

**cm<sup>3</sup>**

**NO. OF VALVES**

**RENAULT**
**Laguna II, Grantour**

1.9 dCi	79	03/01 →	1.870	D	M	4	8	F9Q718, F9Q754	81814	
	79	03/01 →	1.870	D	M	4	8	F9Q718, F9Q754	84009	
	85	09/05 →	1.870	D	M	4	8	F9Q750	81814	
	85	09/05 →	1.870	D	M	4	8	F9Q750	84009	
	92	09/05 →	1.870	D	M	4	8	F9Q750	81814	
	92	09/05 →	1.870	D	M	4	8	F9Q750	84009	
	68	03/04 →	1.870	D	M	4	8	F9Q664	81868	
	68	03/04 →	1.870	D	M	4	8	F9Q664	84006	
	74	10/01 →	1.870	D	M	4	8	F9Q752	81814	
	74	10/01 →	1.870	D	M	4	8	F9Q752	84009	
	74	10/01 →	1.870	D	M	4	8	F9Q754	81814	
	74	10/01 →	1.870	D	M	4	8	F9Q754	84009	
	77	06/01 →	1.870	D	AM	4	8	F9Q752	81814	
	77	06/01 →	1.870	D	AM	4	8	F9Q752	84009	
	81	01/05 →	1.870	D	M	4	8	F9Q674, F9Q758	81868	
	81	01/05 →	1.870	D	M	4	8	F9Q674, F9Q758	84006	
	85	08/05 → 09/07	1.870	D	M	4	8	F9Q758, F9Q759	81814	
	85	08/05 → 09/07	1.870	D	M	4	8	F9Q758, F9Q759	84009	
	2.0 16V	88	03/01 →	1.870	D	M	4	8	F9Q650, F9Q670, F9Q674, F9Q750	81814
		88	03/01 →	1.870	D	M	4	8	F9Q650, F9Q670, F9Q674, F9Q750	84009
88		03/01 →	1.870	D	M	4	8	F9Q670, F9Q674, F9Q750	81814	
88		03/01 →	1.870	D	M	4	8	F9Q670, F9Q674, F9Q750	84009	
96		05/05 →	1.870	D	M	4	8	F9Q758, F9Q759	81868	
96		05/05 →	1.870	D	M	4	8	F9Q758, F9Q759	84006	
98		08/02 →	1.998	B	M	4	16	F4R714	81814	
98		08/02 →	1.998	B	M	4	16	F4R714	84009	
98		10/04 → 09/07	1.998	B	M	4	16	F4R714, F4R715	81814	
98		10/04 → 09/07	1.998	B	M	4	16	F4R714, F4R715	84009	
2.0 16V IDE	125	01/05 →	1.998	B	M	4	16	F4R784, F4R786, F4R787	81814	
	125	01/05 →	1.998	B	M	4	16	F4R784, F4R786, F4R787	84009	
	150	01/05 →	1.998	B	M	4	16	F4R886, F4R887	81814	
	150	01/05 →	1.998	B	M	4	16	F4R886, F4R887	84009	
	99	08/02 →	1.998	B	M	4	16	F4R712, F4R713, F4R714, F4R715	81814	
	99	08/02 →	1.998	B	M	4	16	F4R712, F4R713, F4R714, F4R715	84009	

--	--	--	--	--	--	--	--	--	--

## RENAULT

### Laguna II, Grantour

2.0 16V Turbo	120	01/03 →	1.998	B	M	4	16	F4R764, F4R765, F4R786, F4R787	81814
	120	01/03 →	1.998	B	M	4	16	F4R764, F4R765, F4R786, F4R787	84009
2.0 dCi	110	08/05 →	1.995	D	M	4	16	M9R740	82069
	127	01/06 →	1.995	D	M	4	16	M9R760	82069
2.2 dCi	102	05/05 →	2.188	D	M	4	16	G9T600, G9T605, G9T706, G9T707	81855
	102	05/05 →	2.188	D	M	4	16	G9T600, G9T706, G9T707	81855
	85	04/04 → 10/05	2.188	D	M	4	16	G9T600	81855
	110	10/01 →	2.188	D	AM	4	16	G9T700, G9T702	81855
	110	10/01 →	2.188	D	AM	4	16	G9T702	81855
3.0 V6 24V	152	03/01 →	2.946	B	A	6	24	L7X731	81813
	152	03/01 →	2.946	B	M	6	24	L7X731	81813

### Laguna III, Grantour, Coupé

1.5 dCi	81	03/12 →	1.461	D	M	4	8	K9K846	82098
	81	10/07 →	1.461	D	M	4	8	K9K780	84007
1.6 16V	81	10/07 →	1.598	B	M	4	16	K4M824	84039
	81	10/07 →	1.598	B	M	4	16	K4M824	81806
2.0 16V Turbo	125	10/07 →	1.998	B	M	4	16	F4R811	81814
	125	10/07 →	1.998	B	M	4	16	F4R811	84009
	125	09/08 →	1.998	B	M	4	16	F4R811, F4Rt811	81814
	125	09/08 →	1.998	B	M	4	16	F4R811, F4Rt811	84009

### Laguna III, Grantour, Coupé

2.0 dCi	127	09/08 →	1.995	D	M	4	16	M9R800, M9R809, M9R815	82069
	96	10/07 →	1.995	D	M	4	16	M9R742, M9R744, M9R802	82069
	110	09/08 →	1.995	D	M	4	16	M9R802, M9R805, M9R814	82069
	127	01/08 →	1.995	D	M	4	16	M9R800, M9R809, M9R815	82069
2.0 dCi GT	131	03/08 →	1.995	D	M	4	16	M9R816	82069
	131	09/08 →	1.995	D	M	4	16	M9R816, M9R820	82069
2.0 GT	150	09/08 →	1.998	B	M	4	16	F4R800	81814
	150	09/08 →	1.998	B	M	4	16	F4R800	84009
3.0 dCi	177	01/12 →	2.998	D	M	6	24	V9X891	82069
	173	09/08 →	2.998	D	M	6	24	V9X791, V9X891	82069

### Latitude

1.5 dCi	81	07/10 →	1.461	D	M	4	8	K9K782	82098
2.0 dCi 150	110	02/11 →	1.995	D	M	4	16	M9R824, M9R846	82069
2.0 dCi 175	127	05/11 →	1.995	D	M	4	16	M9R804, M9R817, M9R844	82069



KW



cm<sup>3</sup>



NO. OF  
VALVES



MAGNETI  
MARELLI

## RENAULT

### Latitude

3.0 dCi 240	177	02/11 →	2.998	D	M	6	24	V9X891		82069
-------------	-----	---------	-------	---	---	---	----	--------	--	-------

### Logan I, Station Wagon

1.4	55	09/04 →	1.390	B	M	4	8	K7J710		81579
1.5 dCi	50	04/07 →	1.461	D	M	4	8	K9K792		84007
1.6	64	09/04 →	1.598	B	M	4	8	K7M710		81579
	77	04/07 →	1.598	B	M	4	16	K4M690		84039 <b>NEW</b>
	77	04/07 →	1.598	B	M	4	16	K4M690		81806

### Logan I, Station Wagon, Express

1.4	55	10/07 →	1.390	B	M	4	8	K7J710		81579
1.5 dCi	50	04/07 →	1.461	D	M	4	8	K9K792		81810
	50	04/07 →	1.461	D	M	4	8	K9K792		84007
1.6	64	04/07 →	1.598	B	M	4	8	K7M710		81579
	77	04/07 →	1.598	B	M	4	16	K4M697		84039 <b>NEW</b>
	77	04/07 →	1.598	B	M	4	16	K4M697		81806

### Master I

28-35 2,5 D	55	08/89 → 07/98	2.499	D	M	4	8	8140.67.2510, S8U742		81334
28-35 2.0	58	10/86 → 07/98	1.995	B	M	4	8	J5R718	→ M: F029.328	81828
	58	10/86 → 07/98	1.995	B	M	4	8	J5R718	M →: F029.329	81754
	58	10/86 → 07/98	1.995	B	M	4	8	J5R728	→ M: F029.328	81828
	58	10/86 → 07/98	1.995	B	M	4	8	J5R728	M →: F029.329	81754
28-35 2.1 D	44	08/80 → 07/98	2.068	D	M	4	8	J8S330		81576
28-35 2.5 D	52	09/80 → 07/98	2.445	D	M	4	8	8140.61.2300, S8U731		81334
	55	08/89 → 07/98	2.499	D	M	4	8	8140.67.2510, S8U742		81334
30 2,2	67	08/80 → 07/98	2.165	B	M	4	8	J7T782, J7T788	→ M: F305.272	81828
	67	08/80 → 07/98	2.165	B	M	4	8	J7T782, J7T788	M →: F305.273	81666

### Master II

1.9 dCi 80	60	11/01 →	1.870	D	M	4	8	F9Q772, F9Q774		81814
	60	11/01 →	1.870	D	M	4	8	F9Q772, F9Q774		84009
1.9 dTI	59	09/00 →	1.870	D	M	4	8	F9Q770		81574
2.2 dCi 90	66	09/00 →	2.188	D	M	4	16	G9T720, G9T722, G9T750		81855
2.5 D	59	07/98 → 01/01	2.499	D	M	4	8	S8U770	11-1989 →	81491
	59	07/98 → 01/01	2.499	D	M	4	8	S8U770		81834
2.5 dCi	74	08/06 →	2.464	D	M	4	16	G9U650, G9U754		81855
	84	01/04 →	2.464	D	M	4	16	G9U750		81855
	88	08/06 →	2.464	D	M	4	16	G9U650		81855
	107	08/06 →	2.464	D	M	4	16	G9U632		81855
2.5 dCi 100	73	10/03 →	2.463	D	M	4	16	G9U754		81855
2.5 dCi 120	84	10/01 →	2.463	D	M	4	16	G9U720, G9U724, G9U750, G9U754		81855
	84	10/01 →	2.463	D	M	4	16	G9U720, G9U750, G9U754		81855
2.8 dTI	84	07/98 → 10/01	2.799	D	M	4	8	S9W702	→ 12-1999	81834
	84	07/98 → 10/01	2.799	D	M	4	8	S9W702	01-2000 →	81835

--	--	--	--	--	--	--	--	--	--

## RENAULT

### Master III

2.3 dCi 100 FWD	74	02/11 →	2.299	D	M	4	16	M9T670, M9T672, M9T676, M9T870	82069
2.3 dCi 125 FWD	92	02/11 →	2.299	D	M	4	16	M9T670, M9T672, M9T676, M9T870	82069
2.3 dCi 150	110	10/12 →	2.299	D	M	4	16	M9T880	82069
2.3 dCi FWD	110	03/13 →	2.299	D	M	4	16	M9T880, M9T898	82069
	74	02/10 →	2.298	D	M	4	16	M9T670, M9T672, M9T676, M9T870, M9T890	82069
	92	02/10 →	2.298	D	M	4	16	M9T670, M9T672, M9T676, M9T696, M9T698, M9T870, M9T890, M9T896	82069
	92	02/10 →	2.298	D	M	4	16	M9T670, M9T672, M9T676, M9T698, M9T870, M9T890, M9T896	82069
	107	02/10 →	2.298	D	M	4	16	M9T678, M9T680, M9T694, M9T696, M9T698, M9T896	82069
	107	02/10 →	2.298	D	M	4	16	M9T678, M9T680, M9T698, M9T896	82069
	107	02/11 →	2.299	D	M	4	16	M9T680	82069

### Megane I, Coach, Cabrio, Scénic, Station Wagon

1.4	55	09/96 → 08/03	1.390	B	M	4	8	E7J626, E7J764	81578
1.4 16V	70	03/99 → 08/03	1.390	B	M	4	16	K4J714, K4J750	84039 <b>NEW</b>
	70	03/99 → 08/03	1.390	B	M	4	16	K4J714, K4J750	81806
1.4 e	55	03/99 → 08/03	1.390	B	M	4	8	E7J626	81578
	55	01/96 → 08/03	1.390	B	M	4	8	E7J626, E7J764	81578
1.4 Eco	52	01/96 → 03/99	1.390	B	M	4	8	E7J624	81578
1.4 i	55	01/97 → 09/99	1.390	B	M	4	8	E7J764	81578
1.6 16V	79	03/99 → 08/03	1.598	B	M	4	16	K4M700, K4M701, K4M704, K4M708	84039 <b>NEW</b>
	79	03/99 → 08/03	1.598	B	M	4	16	K4M700, K4M701, K4M704, K4M708	81806
	79	03/99 → 08/03	1.598	B	M	4	16	K4M700, K4M701, K4M708	84039 <b>NEW</b>
	79	03/99 → 08/03	1.598	B	M	4	16	K4M700, K4M701, K4M708	81806
1.6 e	66	10/96 → 03/99	1.598	B	M	4	8	K7M702, K7M703	81579
	66	01/96 → 03/99	1.598	B	M	4	8	K7M702, K7M703, K7M790	81579
1.6 i	55	01/96 → 03/99	1.598	B	M	4	8	K7M720	81579
1.6 LPG	80	10/00 → 08/02	1.598		M	4	16	K4M704	84039 <b>NEW</b>
	80	10/00 → 08/02	1.598		M	4	16	K4M704	81806
1.8 16V	85	01/01 → 08/03	1.783	B	M	4	16	F4P720, F4P722	81574

	<b>KW</b>		<b>cm<sup>3</sup></b>				<b>NO. OF VALVES</b>			<b>MAGNETI MARELLI</b>
--	-----------	--	-----------------------	--	--	--	----------------------	--	--	------------------------

## RENAULT

### Megane I, Coach, Cabrio, Scénic, Station Wagon

1.9 D	69	04/96 → 02/01	1.870	D	M	4	8	F8Q784		81574
	47	09/96 → 08/03	1.870	D	M	4	8	F8Q620, F8Q624		81574
	47	04/99 → 08/03	1.870	D	M	4	8	F8Q622, F8Q790		81574
	47	03/97 → 09/99	1.870	D	M	4	8	F8Q790		81574
1.9 D Eco	47	01/96 → 08/03	1.870	D	M	4	8	F8Q620, F8Q624		81574
1.9 dCi	77	03/99 → 09/00	1.870	D	M	4	8	F9Q733		81574
	75	02/01 → 08/03	1.870	D	M	4	8	F9Q732, F9Q733		81814
	75	02/01 → 08/03	1.870	D	M	4	8	F9Q732, F9Q733		84009
	75	02/01 → 08/03	1.870	D	M	4	8	F9Q732, F9Q733, F9Q738		81814
1.9 dT	66	01/96 → 08/03	1.870	D	M	4	8	F8Q784, F8Q786		81574
	60	02/00 → 09/00	1.870	D	M	4	8	F9Q730		81574
1.9 dTi	59	02/01 → 08/03	1.870	D	M	4	8	F9Q744		81574
	72	03/97 → 02/01	1.870	D	M	4	8	F9Q730, F9Q731, F9Q734, F9Q736		81574
	72	04/97 → 09/99	1.870	D	M	4	8	F9Q730, F9Q734		81574
	72	03/97 → 02/01	1.870	D	M	4	8	F9Q731, F9Q734, F9Q736		81574
	72	03/99 → 02/01	1.870	D	M	4	8	F9Q731, F9Q736		81574
1.9 TDI	69	09/96 → 08/03	1.870	D	M	4	8	F8Q784	10-1996 →	81574
	69	09/96 → 08/03	1.870	D	M	4	8	F8Q784		81574
2.0	84	04/97 → 08/03	1.998	B	M	4	8	F3R750, F3R798		81574
2.0 16V	102	01/02 → 08/03	1.998	B	M	4	16	F4R746		81574
	102	01/02 → 08/03	1.998	B	M	4	16	F4R746, F4R770		81574
	108	07/96 → 08/03	1.998	B	M	4	16	F7R710, F7R714		81574
2.0 16V IDE	103	11/99 → 08/03	1.998	B	M	4	16	F4R746, F5R740		81574
	103	11/99 → 08/03	1.998	B	M	4	16	F5R740		81574
2.0 i	80	03/99 → 08/03	1.998	B	M	4	8	F3R750, F3R751		81574
	80	03/99 → 08/03	1.998	B	M	4	8	F3R791, F3R796		81574
	80	03/99 → 08/03	1.998	B	M	4	8	F3R750, F3R751, F3R752, F3R791, F3R796, F3R797, F3R798		81574
	80	03/99 → 08/03	1.998	B	M	4	8	F3R791, F3R796		81574
	80	01/99 → 09/99	1.998	B	M	4	8	F3R796		81574
	84	01/96 → 08/03	1.998	B	M	4	8	F3R750, F3R751		81574
	84	09/96 → 08/03	1.998	B	M	4	8	F3R750, F3R751, F3R752, F3R791, F3R796, F3R797, F3R798		81574
	84	03/96 → 08/03	1.998	B	M	4	8	F3R750, F3R751, F3R798		81574
2.0 RXE 4x4	84	05/97 → 10/99	1.998	B	M	4	8	F3R750		81574



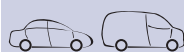

KW



cm<sup>3</sup>



NO. OF VALVES



MAGNETI MARELLI

**RENAULT**

**Megane II, Station Wagon, Coupé-Cabrio**

1.4	60	09/03 →	1.390	B	M	4	16	K4J732		84039	<b>NEW</b>
	60	09/03 →	1.390	B	M	4	16	K4J732		81806	
	72	08/03 → 07/09	1.390	B	M	4	16	K4J730, K4J740		84039	<b>NEW</b>
	72	08/03 → 07/09	1.390	B	M	4	16	K4J730, K4J740		81806	
1.4 16V	60	10/03 → 02/08	1.390	B	M	4	16	K4J732		84039	<b>NEW</b>
	60	10/03 → 02/08	1.390	B	M	4	16	K4J732		81806	
	72	11/02 → 02/08	1.390	B	M	4	16	K4J730, K4J740		84039	<b>NEW</b>
	72	11/02 → 02/08	1.390	B	M	4	16	K4J730, K4J740		81806	
1.5 dCi	60	08/03 → 05/06	1.461	D	M	4	8	K9K722	→ 03-2004	81810	
	60	08/03 → 05/06	1.461	D	M	4	8	K9K722	04-2004 →	84007	
	60	09/03 →	1.461	D	M	4	8	K9K722	03-2004 →	84007	
	63	05/05 → 02/08	1.461	D	M	4	8	K9K724		84007	
	74	10/03 → 03/06	1.461	D	M	4	8	K9K728, K9K729		84007	
	76	01/07 → 02/08	1.461	D	M	4	8	K9K734		84007	
	78	05/05 →	1.461	D	M	4	8	K9K732		84007	
	78	05/05 → 06/08	1.461	D	M	4	8	K9K732, K9K734		84007	
	60	11/02 → 02/08	1.461	D	M	4	8	K9K722	→ 03-2004	81810	
	60	11/02 → 02/08	1.461	D	M	4	8	K9K722	04-2004 →	84007	
	76	01/07 → 07/09	1.461	D	M	4	8	K9K728		84007	
	76	01/07 → 06/09	1.461	D	M	4	8	K9K734		84007	
	78	03/06 → 06/08	1.461	D	M	4	8	K9K732		84007	
	78	05/05 → 06/08	1.461	D	M	4	8	K9K732, K9K734		84007	
1.6	75	09/03 →	1.598	B	M	4	16	K4M768		84039	<b>NEW</b>
	75	09/03 →	1.598	B	M	4	16	K4M768		81806	
	77	05/05 →	1.598	B	M	4	16	K4M762		84039	<b>NEW</b>
	77	05/05 →	1.598	B	M	4	16	K4M762		81806	
	77	06/05 → 02/08	1.598	B	M	4	16	K4M788		84039	<b>NEW</b>
	77	06/05 → 02/08	1.598	B	M	4	16	K4M788		81806	
	83	09/03 → 03/09	1.598	B	M	4	16	K4M760, K4M761		84039	<b>NEW</b>
	83	09/03 → 03/09	1.598	B	M	4	16	K4M760, K4M761		81806	
1.6 16V	77	05/05 → 07/09	1.598	B	M	4	16	K4M762		84039	<b>NEW</b>
	77	05/05 → 07/09	1.598	B	M	4	16	K4M762		81806	
	82	01/06 → 06/08	1.598	B	M	4	16	K4M760, K4M761, K4M812, K4M813		84039	<b>NEW</b>
	82	01/06 → 06/08	1.598	B	M	4	16	K4M760, K4M761, K4M812, K4M813		81806	
	82	01/06 → 06/08	1.598	B	M	4	16	K4M760, K4M812, K4M813		84039	<b>NEW</b>
	82	01/06 → 06/08	1.598	B	M	4	16	K4M760, K4M812, K4M813		81806	
	82	01/06 →	1.598	B	M	4	16	K4M812, K4M813		84039	<b>NEW</b>
	82	01/06 →	1.598	B	M	4	16	K4M812, K4M813		81806	
83	11/02 → 02/08	1.598	B	M	4	16	K4M760		84039	<b>NEW</b>	
83	11/02 → 02/08	1.598	B	M	4	16	K4M760		81806		

**KW**

**cm<sup>3</sup>**

**NO. OF VALVES**

**RENAULT**
**Megane II, Station Wagon, Coupé-Cabrio**

1.6 16V Hi-Flex	77	02/08 → 07/09	1.598		M	4	16	K4M856		84039	<b>NEW</b>
	77	02/08 → 07/09	1.598		M	4	16	K4M856		81806	
1.6 Flex-Fuel	77	01/07 → 02/08	1.598		M	4	16	K4M788		84039	<b>NEW</b>
	77	01/07 → 02/08	1.598		M	4	16	K4M788		81806	
1.9 dCi	66	11/02 → 12/05	1.870	D	M	4	8	F9Q808		81868	
	66	11/02 → 12/05	1.870	D	M	4	8	F9Q808		84006	
	68	03/04 → 08/06	1.870	D	M	4	8	F9Q808		81868	
	68	03/04 → 08/06	1.870	D	M	4	8	F9Q808		84006	
	81	05/05 → 03/09	1.870	D	M	4	8	F9Q804, F9Q816, F9Q818		81868	
	81	05/05 → 03/09	1.870	D	M	4	8	F9Q804, F9Q816, F9Q818		84006	
	81	05/05 → 02/08	1.870	D	M	4	8	F9Q804, F9Q818		81868	
	81	05/05 → 02/08	1.870	D	M	4	8	F9Q804, F9Q818		84006	
	85	11/02 → 02/08	1.870	D	M	4	8	F9Q804, F9Q816, F9Q818		81868	
	85	11/02 → 02/08	1.870	D	M	4	8	F9Q804, F9Q816, F9Q818		84006	
	85	05/05 → 07/09	1.870	D	M	4	8	F9Q818		81868	
	85	05/05 → 07/09	1.870	D	M	4	8	F9Q818		84006	
	88	09/03 → 03/09	1.870	D	M	4	8	F9Q800		81868	
	88	09/03 → 03/09	1.870	D	M	4	8	F9Q800		84006	
	96	05/05 → 02/07	1.870	D	M	4	8	F9Q803, F9Q804		81868	
	96	05/05 → 02/07	1.870	D	M	4	8	F9Q803, F9Q804		84006	
	96	05/05 → 12/09	1.870	D	M	4	8	F9Q803, F9Q804, F9Q816, F9Q818		81868	
	96	05/05 → 12/09	1.870	D	M	4	8	F9Q803, F9Q804, F9Q816, F9Q818		84006	
	81	05/05 →	1.870	D	M	4	8	F9Q803, F9Q804, F9Q816, F9Q818		81868	
	81	05/05 →	1.870	D	M	4	8	F9Q803, F9Q804, F9Q816, F9Q818		84006	
2.0	99	09/03 → 12/09	1.998	B	M	4	16	F4R770, F4R771		81814	
	99	09/03 → 12/09	1.998	B	M	4	16	F4R770, F4R771		84009	
	102	09/03 → 02/07	1.998	B	M	4	16	F4R770		81814	
	102	09/03 → 02/07	1.998	B	M	4	16	F4R770		84009	
	169	08/06 → 02/08	1.998	B	M	4	16	F4R774		81814	
	169	08/06 → 02/08	1.998	B	M	4	16	F4R774		84009	
2.0 16V	99	11/02 → 02/08	1.998	B	M	4	16	F4R770		81814	
	99	11/02 → 02/08	1.998	B	M	4	16	F4R770		84009	
2.0 16V Turbo	120	05/04 → 02/08	1.998	B	M	4	16	F4R776		81814	
	120	05/04 → 02/08	1.998	B	M	4	16	F4R776		84009	

	<b>KW</b>		<b>cm<sup>3</sup></b>				<b>NO. OF VALVES</b>		
--	-----------	--	-----------------------	--	--	--	----------------------	--	--

## RENAULT

### Megane II, Station Wagon, Coupé-Cabrio

2.0 dCi	110	09/05 → 03/09	1.995	D	M	4	16	M9R700, M9R722	82069
	127	01/07 → 02/08	1.995	D	M	4	16	M9R724	82069
	110	09/05 → 02/08	1.995	D	M	4	16	M9R700, M9R722	82069
2.0 Renault Sport	165	05/04 → 10/09	1.998	B	M	4	16	F4R774, F4Rt774	81814
	165	05/04 → 10/09	1.998	B	M	4	16	F4R774, F4Rt774	84009

### Megane III, Station Wagon, Coupé, CC

1.2 TCe	97	01/13 →	1.197	B	M	4	16	H5F404	84003
1.4 TCe	96	06/10 →	1.397	B	M	4	16	H4J700	84003
1.5 dCi	63	03/09 →	1.461	D	M	4	8	K9K830	81810
	63	12/09 →	1.461	D	M	4	8	K9K830	84007
	78	02/09 →	1.461	D	M	4	8	K9KG832	84007
	63	11/08 →	1.461	D	M	4	8	K9K830	84007
	66	05/09 →	1.461	D	M	4	8	K9K834	82098
	66	11/08 →	1.461	D	M	4	8	K9KH834	82098
	78	02/09 →	1.461	D	M	4	8	K9K832	84007
	78	02/09 →	1.461	D	M	4	8	K9K836, K9K846	84007
	81	02/09 →	1.461	D	M	4	8	K9K636, K9K656, K9K657, K9K836, K9K837, K9K846	82098
	81	02/09 →	1.461	D	M	4	8	K9K636, K9K836, K9K837, K9K846	82098
1.6 16V	81	02/09 →	1.461	D	M	4	8	K9K636, K9K837, K9K846, K9KJ836	82098
	81	06/10 →	1.461	D	M	4	8	K9K837	82098
	82	11/08 →	1.598	B	M	4	16	K4M858, K4M866	84039 <b>NEW</b>
	82	11/08 →	1.598	B	M	4	16	K4M858, K4M866	81806
	74	11/08 →	1.598	B	M	4	16	K4M848	84039 <b>NEW</b>
	74	11/08 →	1.598	B	M	4	16	K4M848	81806
1.6 16V Bifuel	81	06/10 →	1.598	B	M	4	16	K4M858	84039 <b>NEW</b>
	81	06/10 →	1.598	B	M	4	16	K4M858	81806
1.6 dCi	81	11/08 →	1.598	BF	M	4	16	K4M866	84039 <b>NEW</b>
	81	11/08 →	1.598	BF	M	4	16	K4M866	81806
1.6 TCe	96	04/11 →	1.598	D	M	4	16	R9M402	84034 <b>NEW</b>
	96	04/11 →	1.598	D	M	4	16	R9M402, R9M404	84034 <b>NEW</b>
1.6 TCe	96	01/11 →	1.598	B	M	4	16		84039 <b>NEW</b>
	96	01/11 →	1.598	B	M	4	16		81806
1.9 dCi	96	06/10 →	1.870	D	M	4	8	F9Q870	82099
	96	11/08 →	1.870	D	M	4	8	F9Q870, F9Q872	82099
2.0 CVT	103	05/09 →	1.997	B	M	4	16	M4R711, M4RF713	82069
2.0 dCi	120	07/12 →	1.995	D	M	4	16	M9R610	82069
	110	10/10 →	1.995	D	M	4	16	M9R615	82069
	118	06/10 →	1.995	D	M	4	16	M9R610	82069
2.0 R.S.	195	11/08 →	1.998	B	M	4	16	F4R874	81814
	195	11/08 →	1.998	B	M	4	16	F4R874	84009

**KW**

**cm<sup>3</sup>**

**NO. OF VALVES**

**RENAULT**
**Megane III, Station Wagon, Coupé, CC**

2.0 TCe	140	06/12 →	1.998	B	M	4	16	F4R872		81814
	140	06/12 →	1.998	B	M	4	16	F4R872		84009
	162	09/12 →	1.998	B	M	4	16	F4R874		81814
	162	09/12 →	1.998	B	M	4	16	F4R874		84009
	132	11/08 →	1.998	B	M	4	16	F4R870		81814
	132	11/08 →	1.998	B	M	4	16	F4R870		84009
	132	06/10 →	1.998	B	M	4	16	F4R870, F4R872		81814
	132	06/10 →	1.998	B	M	4	16	F4R870, F4R872		84009
	184	05/09 →	1.998	B	M	4	16	F4R874		81814
	184	05/09 →	1.998	B	M	4	16	F4R874		84009

**Megane IV**

1.2 TCe 100	74	11/15 →	1.197	B	M	4	16			84003
1.2 TCe 130	97	11/15 →	1.197	B	M	4	16			84003
1.5 dCi 110	81	11/15 →	1.461	D	M	4	8			82098
1.5 dCi 90	66	11/15 →	1.461	D	M	4	8			82098
1.6 dCi 130	96	11/15 →	1.598	D	M	4	16			84034 <b>NEW</b>

**Modus**

1.2	76	04/11 →	1.149	B	M	4	16	D4F786		82090
	48	05/05 →	1.149	B	M	4	16	D4F740		81820
	55	12/04 →	1.149	B	M	4	16	D4F740		81820
	58	12/04 →	1.149	B	M	4	16	D4F764		81820
1.2 16V	74	05/07 →	1.149	B	M	4	16	D4F784		81820
1.2 16V Hi-Flex	55	10/08 →	1.149		M	4	16	D4F740		81820
1.4	72	12/04 →	1.390	B	M	4	16	K4J770, K4J780		84039 <b>NEW</b>
	72	12/04 →	1.390	B	M	4	16	K4J770, K4J780		81806
1.5 dCi	48	12/04 →	1.461	D	M	4	8	K9K752		84007
	50	12/04 →	1.461	D	M	4	8	K9K762, K9K768		81810
	60	09/04 →	1.461	D	M	4	8	K9K750		84007
	63	12/04 →	1.461	D	M	4	8	K9K760, K9K766		81810
	76	05/07 →	1.461	D	M	4	8	K9K772		84007
	78	05/05 →	1.461	D	M	4	8	K9K764		84007
1.5 dCi 75	55	10/10 →	1.461	D	M	4	8	K9K770		84007
1.5 dCi 90	65	10/10 →	1.461	D	M	4	8	K9K750		84007
1.6	65	12/04 →	1.598	B	M	4	16	K4M794		84039 <b>NEW</b>
	65	12/04 →	1.598	B	M	4	16	K4M794		81806
	82	12/04 →	1.598	B	M	4	16	K4M790, K4M791, K4M800, K4M801		84039 <b>NEW</b>
	82	12/04 →	1.598	B	M	4	16	K4M790, K4M791, K4M800, K4M801		81806

**Rapid**

1.0	27	02/86 → 05/92	956	B	M	4	8	C1C706	(-)COP, (-)AC	81573
	27	02/86 → 05/92	956	B	M	4	8	C1C706	(-)COP, (+)AC	81756
	27	02/86 → 05/92	956	B	M	4	8	C1C706	(+)COP, (-)AC	81811
	27	02/86 → 05/92	956	B	M	4	8	C1C706	(+)COP, (+)AC	81853

**KW**

**cm<sup>3</sup>**

**NO. OF VALVES**

**RENAULT**
**Rapid**

1.1	33	07/85 → 04/95	1.108	B	M	4	8	C1E750, C1E752, C1E754, C1E756, C1E760, C1E762, C1E792	(-)COP, (-)AC	81573
	33	07/85 → 04/95	1.108	B	M	4	8	C1E750, C1E752, C1E754, C1E756, C1E760, C1E762, C1E792	(-)COP, (+)AC	81756
	33	07/85 → 04/95	1.108	B	M	4	8	C1E750, C1E752, C1E754, C1E756, C1E760, C1E762, C1E792	(+)COP, (-)AC	81811
	33	07/85 → 04/95	1.108	B	M	4	8	C1E750, C1E752, C1E754, C1E756, C1E760, C1E762, C1E792	(+)COP, (+)AC	81853
1.2	40	09/91 → 03/98	1.239	B	M	4	8	C3G710, C3G712	(-)COP	81596
	40	09/91 → 03/98	1.239	B	M	4	8	C3G710, C3G712	(-)COP, (-)AC	81573
	40	09/91 → 03/98	1.239	B	M	4	8	C3G710, C3G712	(-)COP, (+)AC	81756
	40	09/91 → 03/98	1.239	B	M	4	8	C3G710, C3G712	(+)COP, (-)AC	81811
	40	09/91 → 03/98	1.239	B	M	4	8	C3G710, C3G712	(+)COP, (+)AC	81853
	40	09/91 → 03/98	1.239	B	M	4	8	C3G710, C3G712	(+)COP, 05-1995 →	81854
1.4	55	09/91 → 03/98	1.390	B	M	4	8	E7J720, E7J724, E7J726, E7J773	01-1996 →	81578
	55	09/91 → 03/98	1.390	B	M	4	8	E7J720, E7J724, E7J726, E7J773		81661
	58	01/94 → 03/98	1.390	B	M	4	8	E7J728		81661
	43	07/85 → 03/98	1.397	B	M	4	8	C1J768, C1J780, C3J700, C3J702, C3J760, C3J762	(-)COP, (-)AC	81573
	43	07/85 → 03/98	1.397	B	M	4	8	C1J768, C1J780, C3J700, C3J702, C3J760, C3J762	(-)COP, (+)AC	81756
	43	07/85 → 03/98	1.397	B	M	4	8	C1J768, C1J780, C3J700, C3J702, C3J760, C3J762	(+)COP, (-)AC	81811
	43	07/85 → 03/98	1.397	B	M	4	8	C1J768, C1J780, C3J700, C3J702, C3J760, C3J762	(+)COP, (+)AC	81853
	44	03/86 → 08/91	1.397	B	M	4	8	C2J784	(-)COP, (-)AC	81573
	44	03/86 → 08/91	1.397	B	M	4	8	C2J784	(-)COP, (+)AC	81756
	44	03/86 → 08/91	1.397	B	M	4	8	C2J784	(+)COP, (-)AC	81811
44	03/86 → 08/91	1.397	B	M	4	8	C2J784	(+)COP, (+)AC	81853	

**KW**

**cm<sup>3</sup>**

**NO. OF VALVES**

**RENAULT**
**Rapid**

1.6 D	40	09/93 → 04/95	1.595	D	M	4	8	F8M736		81574
	40	03/86 → 08/98	1.596	D	M	4	8	F8M720, F8M730, F8M736, F8M760		81574
1.9 D	40	09/94 → 03/98	1.870	D	M	4	8	F8Q640, F8Q682		81574
	47	09/91 → 03/98	1.870	D	M	4	8	F8Q646, F8Q722, F8Q724, F8Q774, F8Q776		81574

**Safrane I**

2.0	77	11/92 → 07/96	1.995	B	M	4	8	J7R732, J7R733		81759
2.0 12V	97	04/92 → 07/96	1.995	B	M	4	12	J7R734, J7R735		81759
2.1 dT	65	11/93 → 07/96	2.068	D	M	4	8	J8S760	→ M: 920.501, (-)AC	81757
	65	11/93 → 07/96	2.068	D	M	4	8	J8S760	M →: 920.502, (+)AC, (-)AC	81758
2.2	79	04/92 → 07/96	2.165	B	M	4	8	J7T762		81759
	101	04/92 → 07/96	2.165	B	M	4	12	J7T760, J7T761		81759
2.5 dT	83	12/92 → 07/96	2.500	D	M	4	8	S8U762, S8U763		81325
3.0 Biturbo 4x4	193	02/93 → 07/96	2.963	B	M	6	12	Z7X726		81764
3.0 V6	123	12/92 → 07/96	2.963	B	M	6	12	Z7X721, Z7X722, Z7X723, Z7X753		81764
3.0 V6 4x4	123	12/92 → 07/96	2.963	B	M	6	12	Z7X721, Z7X722, Z7X723		81764

**Safrane II**

2.0 16V	100	07/96 → 12/00	1.948	B	M	4	16	N7Q710, N7Q711		81759
2.2 dT	83	07/96 → 12/00	2.188	D	M	4	12	G8T740		81761
2.5 20V	121	07/96 → 12/00	2.435	B	M	5	20	N7U700, N7U701		81846
2.9 24V	140	03/99 → 12/00	2.946	B	A	6	24	L7X713	→ T: 08441	81844
	140	03/99 → 12/00	2.946	B	A	6	24	L7X713	T →: 08442	82042
3.0 V6	123	07/96 → 12/00	2.963	B	M	6	12	Z7X722, Z7X723, Z7X755		81844

**Sandero I**

1.4	55	02/09 →	1.390	B	M	4	8	K7J710		81579
1.6	62	11/10 →	1.598	B	M	4	8	K7M718		81579
	64	02/09 →	1.598	B	M	4	8	K7M710		81579
	75	12/07 →	1.598	B	M	4	8	K7M710		81579
	76	12/07 →	1.598	B	M	4	16	K4M690		81579

**Scénic I**

1.4 16V	70	09/99 → 08/03	1.390	B	M	4	16	K4J714, K4J750		84039 <b>NEW</b>
	70	09/99 → 08/03	1.390	B	M	4	16	K4J714, K4J750		81806
1.6	75	03/01 → 08/03	1.598	B	M	4	16	K4M708, K4M709		81574
	79	09/99 → 09/03	1.598	B	M	4	16	K4M700, K4M706		84039 <b>NEW</b>
	79	09/99 → 09/03	1.598	B	M	4	16	K4M700, K4M706		81806
1.6 BiFuel	79	09/99 → 04/01	1.598	BF	M	4	16	K4M704		84039 <b>NEW</b>
	79	09/99 → 04/01	1.598	BF	M	4	16	K4M704		81806
1.8 16V	85	01/01 → 08/03	1.783	B	M	4	16	F4P720, F4P722		81574
1.8 4x4	85	07/00 → 04/01	1.783	B	M	4	16	F4P722		81574

KW	cm³				NO. OF VALVES			

## RENAULT

### Scénic I

1.9 D	47	09/99 → 03/01	1.870	D	M	4	8	F8Q790		81574
1.9 dCi	75	09/99 → 08/03	1.870	D	M	4	8	F9Q732, F9Q733		81574
1.9 dCi RX4	74	12/02 → 08/03	1.870	D	M	4	8	F9Q732, F9Q748, F9Q796		81574
	75	11/00 → 08/03	1.870	D	M	4	8	F9Q740		81574
1.9 dTi	59	02/01 → 08/03	1.870	D	M	4	8	F9Q744		81574
	72	09/99 → 08/03	1.870	D	M	4	8	F9Q731, F9Q734, F9Q736		81574
2.0 16V	103	09/99 → 08/03	1.998	B	M	4	16	F4R740, F4R741, F4R744, F4R747	10-1996 →	81574
	102	07/00 → 08/03	1.998	B	M	4	16	F4R740, F4R741, F4R746		81574
2.0 16V RX4	102	06/00 → 08/03	1.998	B	M	4	16	F4R744, F4R746		81574

### Scénic II

1.4	72	06/03 →	1.390	B	M	4	16	K4J730, K4J740, K4J770		84039	<b>NEW</b>
	72	06/03 →	1.390	B	M	4	16	K4J730, K4J740, K4J770		81806	
1.5 dCi	60	06/03 →	1.461	D	M	4	8	K9K722	→ 03-2004	81810	
	60	06/03 →	1.461	D	M	4	8	K9K722	04-2004 →	84007	
	63	05/05 →	1.461	D	M	4	8	K9K724		84007	
	74	11/03 →	1.461	D	M	4	8	K9K728, K9K729	→ 03-2004	81810	
	74	11/03 →	1.461	D	M	4	8	K9K728, K9K729	04-2004 →	84007	
	76	01/07 →	1.461	D	M	4	8	K9K734		84007	
1.6	77	06/06 →	1.598	B	M	4	16	K4M788		84039	<b>NEW</b>
	77	06/06 →	1.598	B	M	4	16	K4M788		81806	
	83	06/03 →	1.598	B	M	4	16	K4M761, K4M782		84039	<b>NEW</b>
	83	06/03 →	1.598	B	M	4	16	K4M761, K4M782		81806	
1.6 16V	82	10/05 →	1.598	B	M	4	16	K4M706, K4M766, K4M812, K4M813		84039	<b>NEW</b>
	82	10/05 →	1.598	B	M	4	16	K4M706, K4M766, K4M812, K4M813		81806	
1.9 D	85	06/06 →	1.870	D	M	4	8	F9Q812, F9QJ803		81868	
	85	06/06 →	1.870	D	M	4	8	F9Q812, F9QJ803		84006	
1.9 dCi	92	06/03 →	1.870	D	M	4	8	F9Q804		81868	
	92	06/03 →	1.870	D	M	4	8	F9Q804		84006	
	81	05/05 →	1.870	D	M	4	8	F9Q804		81868	
	81	05/05 →	1.870	D	M	4	8	F9Q804		84006	
	88	06/03 →	1.870	D	M	4	8	F9Q812		81868	
	88	06/03 →	1.870	D	M	4	8	F9Q812		84006	
	96	05/05 →	1.870	D	M	4	8	F9Q804, F9Q816, F9Q818, F9QJ803		81868	
	96	05/05 →	1.870	D	M	4	8	F9Q804, F9Q816, F9Q818, F9QJ803		84006	

**KW**

**cm<sup>3</sup>**

**NO. OF VALVES**

**RENAULT**
**Scénic II**

2.0	99	06/03 →	1.998	B	M	4	16	F4R770, F4R771		81814
2.0	99	06/03 →	1.998	B	M	4	16	F4R770, F4R771		84009
2.0 16V Turbo	120	05/04 →	1.998	B	M	4	16	F4R776		81814
	120	05/04 →	1.998	B	M	4	16	F4R776		84009
2.0 dCi	110	09/05 →	1.995	D	M	4	16	M9R700, M9R721, M9R722		82069

**Scénic III**

1.2 TCe	97	01/13 →	1.197	B	M	4	16	H5F404		84003
1.4 16V	96	02/09 →	1.397	B	M	4	16	H4J700		84003
1.5 dCi	63	04/09 →	1.461	D	M	4	8	K9K830		84007
	70	11/10 →	1.461	D	M	4	8	K9K846		82098
	78	02/09 →	1.461	D	M	4	8	K9K832		84007
	81	04/09 →	1.461	D	M	4	8	K9K636, K9K656, K9K657, K9K836, K9K837		82098
1.6 16V	81	02/09 →	1.598	B	M	4	16	K4M858		84039 <b>NEW</b>
	81	02/09 →	1.598	B	M	4	16	K4M858		81806
1.6 dCi	96	04/11 →	1.598	D	M	4	16	R9M402, R9M404		84034 <b>NEW</b>
1.6 E85	81	02/09 →	1.598	FF	M	4	16	K4M866		84039 <b>NEW</b>
	81	02/09 →	1.598	FF	M	4	16	K4M866		81806
1.9 dCi	96	02/09 →	1.870	D	M	4	8	F9Q870, F9Q872		82099
2.0 dCi	110	02/09 →	1.995	D	M	4	16	M9R615		82069
	118	04/09 →	1.995	D	M	4	16	M9R610		82069

**Sport Spider**

2.0 16V	110	03/95 → 10/99	1.998	B	M	4	16	F7R710		81574
---------	-----	---------------	-------	---	---	---	----	--------	--	-------

**Super 5**

1.1	33	01/86 → 03/95	1.108	B	M	4	8	C1E750, C1E752, C1E756, C1E760	(-)COP, (-)AC	81573
	33	01/86 → 03/95	1.108	B	M	4	8	C1E750, C1E752, C1E756, C1E760	(-)COP, (+)AC	81756
	33	01/86 → 03/95	1.108	B	M	4	8	C1E750, C1E752, C1E756, C1E760	(+)COP, (-)AC	81811
	33	01/86 → 03/95	1.108	B	M	4	8	C1E750, C1E752, C1E756, C1E760	(+)COP, (+)AC	81853
	34	10/84 → 12/96	1.108	B	M	4	8	C1E750, C1E752, C1E754	(-)COP, (-)AC	81573
	34	10/84 → 12/96	1.108	B	M	4	8	C1E750, C1E752, C1E754	(-)COP, (+)AC	81756
	34	10/84 → 12/96	1.108	B	M	4	8	C1E750, C1E752, C1E754	(+)COP, (-)AC	81811
	34	10/84 → 12/96	1.108	B	M	4	8	C1E750, C1E752, C1E754	(+)COP, (+)AC	81853



--	--	--	--	--	--	--	--	--

**RENAULT**
**Super 5**

1.2	40	01/87 → 08/90	1.237	B	M	4	8	C1G702, C1G720, C1G722	(-)COP, (-)AC	81573
	40	01/87 → 08/90	1.237	B	M	4	8	C1G702, C1G720, C1G722	(-)COP, (+)AC	81756
	40	01/87 → 08/90	1.237	B	M	4	8	C1G702, C1G720, C1G722	(+)COP, (-)AC	81811
	40	01/87 → 08/90	1.237	B	M	4	8	C1G702, C1G720, C1G722	(+)COP, (+)AC	81853
	44	01/87 → 12/96	1.237	B	M	4	8	C1G702	(-)COP, (-)AC	81573
	44	01/87 → 12/96	1.237	B	M	4	8	C1G702	(-)COP, (+)AC	81756
	44	01/87 → 12/96	1.237	B	M	4	8	C1G702	(+)COP, (-)AC	81811
	44	01/87 → 12/96	1.237	B	M	4	8	C1G702	(+)COP, (+)AC	81853
1.4	43	10/84 → 12/96	1.397	B	M	4	8	C1J768, C1J780, C3J700, C3J702, C3J760	(-)COP, (-)AC	81573
	43	10/84 → 12/96	1.397	B	M	4	8	C1J768, C1J780, C3J700, C3J702, C3J760	(-)COP, (+)AC	81756
	43	10/84 → 12/96	1.397	B	M	4	8	C1J768, C1J780, C3J700, C3J702, C3J760	(+)COP, (-)AC	81811
	43	10/84 → 12/96	1.397	B	M	4	8	C1J768, C1J780, C3J700, C3J702, C3J760	(+)COP, (+)AC	81853
	44	06/87 → 08/90	1.397	B	M	4	8	C2J784	(-)COP, (-)AC	81573
	44	06/87 → 08/90	1.397	B	M	4	8	C2J784	(-)COP, (+)AC	81756
	44	06/87 → 08/90	1.397	B	M	4	8	C2J784	(+)COP, (-)AC	81811
	44	06/87 → 08/90	1.397	B	M	4	8	C2J784	(+)COP, (+)AC	81853
1.4 Turbo	88	04/85 → 08/90	1.397	B	M	4	8	C1J782, C1J784, C1J788	(-)COP, (-)AC	81573
	88	04/85 → 08/90	1.397	B	M	4	8	C1J782, C1J784, C1J788	(-)COP, (+)AC	81756
	88	04/85 → 08/90	1.397	B	M	4	8	C1J782, C1J784, C1J788	(+)COP, (-)AC	81811
	88	04/85 → 08/90	1.397	B	M	4	8	C1J782, C1J784, C1J788	(+)COP, (+)AC	81853
1.4 Turbo GT	118	01/85 → 05/91	1.397	B	M	4	8	840730	(-)COP, (-)AC	81573
	118	01/85 → 05/91	1.397	B	M	4	8	840730	(-)COP, (+)AC	81756
	118	01/85 → 05/91	1.397	B	M	4	8	840730	(+)COP, (-)AC	81811
	118	01/85 → 05/91	1.397	B	M	4	8	840730	(+)COP, (+)AC	81853
1.6 D	40	10/84 → 12/96	1.595	D	M	4	8	F8M720		81574
	40	08/85 → 12/96	1.596	D	M	4	8	F8M720, F8M730		81574
1.7	54	10/86 → 03/95	1.721	B	M	4	8	F3N716, F3N717		81574
	64	06/87 → 03/95	1.721	B	M	4	8	F2N740, F2N742		81574
1.7 i	69	10/86 → 08/91	1.721	B	M	4	8	F3N702, F3N722		81574

**KW**

**cm<sup>3</sup>**

**NO. OF VALVES**

**MAGNETI MARELLI**
**RENAULT**
**Thalia I**

1.2	43	02/98 → 10/03	1.149	B	M	4	8	D7F744, D7F746		81661
1.2 16V	55	04/02 →	1.149	B	M	4	16	D4F706, D4F712		81820
1.4	55	08/00 →	1.390	B	M	4	8	K7J700		81578
1.4 16V	72	08/00 →	1.390	B	M	4	16	K4J712		84039 <b>NEW</b>
	72	08/00 →	1.390	B	M	4	16	K4J712		81806
1.5 dCi	47	06/05 →	1.461	D	M	4	8	K9K740		84007
	48	04/02 →	1.461	D	M	4	8	K9K700		81810
	50	02/03 →	1.461	D	M	4	8	K9K700, K9K714		84007
	60	06/01 →	1.461	D	M	4	8	K9K702		84007
1.6	66	03/98 →	1.598	B	M	4	8	K7M746		81579
1.6 16V	79	04/02 →	1.598	B	M	4	16	K4M740		84039 <b>NEW</b>
	79	04/02 →	1.598	B	M	4	16	K4M740		81806
1.9 D	48	02/98 → 05/01	1.870	D	M	4	8	F8Q630		81574
2.0	124	09/01 →	1.998	B	M	4	16	F4R738		81574
3.0 V6 Turbo Sport	169	04/00 → 09/01	2.946	B	M	6	24	L7X732		81844
	187	06/02 →	2.946	B	M	6	24	L7X762		81844

**Thalia II**

1.2 16V	55	09/08 →	1.149	B	M	4	16	D4F728		82090
1.5 dCi	47	09/08 →	1.461	D	M	4	8	K9K740		84007
	48	01/09 →	1.461	D	M	4	8	K9K700		81810
	48	01/09 →	1.461	D	M	4	8	K9K700		84007
	62	09/08 →	1.461	D	M	4	8	K9K718		84007
1.6 16V	77	09/08 →	1.598	B	M	4	16	K4M743		84039 <b>NEW</b>
	77	09/08 →	1.598	B	M	4	16	K4M743		81806

**Trafic I**

1.7	50	08/92 → 08/94	1.721	B	M	4	8	F1N720	01-1986 →, → 12-1995	81574
	50	08/92 → 08/94	1.721	B	M	4	8	F1N724	01-1986 →, → 12-1995	81574
1.9 D	44	06/97 → 03/01	1.870	D	M	4	8	F8Q606		81574
2.0	59	05/89 → 08/90	1.995	B	M	4	8	J5R716	01-1981 →, → M: F029.328	81828
	59	05/89 → 08/90	1.995	B	M	4	8	J5R716	01-1981 →, M →: F029.329	81666
	59	05/89 → 08/90	1.995	B	M	4	8	J5R726	01-1981 →, → 08-1994	81828
2.1 D	43	05/89 → 06/94	2.068	D	M	4	8	852720, 852750		81664
	43	05/89 → 06/94	2.068	D	M	4	8	852750	01-1981 →, → 12-1995	81664
	47	06/94 → 10/97	2.068	D	M	4	8	J8S620, J8S758	09-1994 →	81608
2.2	70	05/89 → 06/94	2.165	B	M	4	8	J7T780	01-1981 →	81828
	74	06/94 → 10/97	2.165	B	M	4	8	J7T600	01-1981 →, → M: F305.272	81828
	74	06/94 → 10/97	2.165	B	M	4	8	J7T600	01-1981 →, M →: F305.273	81666

		<b>KW</b>		<b>cm<sup>3</sup></b>				<b>NO. OF VALVES</b>		
--	--	-----------	--	-----------------------	--	--	--	----------------------	--	--

## RENAULT

### Traffic I

2.5 D	51	05/89 → 03/01	2.445	D	M	4	8	8140.61.240, S8U720, S8U722	81334
	55	05/89 → 03/01	2.499	D	M	4	8	8140.67.2500, 8140.67.2550, 8140.67.2580, S8U750, S8U752, S8U758	81334

### Traffic II

1.9 dCi	59	04/01 → 07/03	1.870	D	M	4	8	F9Q762	81814
	59	04/01 → 07/03	1.870	D	M	4	8	F9Q762	84009
	75	03/01 →	1.870	D	M	4	8	F9Q760	81814
	75	03/01 →	1.870	D	M	4	8	F9Q760	84009
1.9 dCi 100	74	03/01 →	1.870	D	M	4	8	F9Q760	81814
	74	03/01 →	1.870	D	M	4	8	F9Q760	84009
1.9 dCi 80	60	03/01 →	1.870	D	M	4	8	F9Q760, F9Q762	81814
	60	03/01 →	1.870	D	M	4	8	F9Q760, F9Q762	84009
	60	03/01 →	1.870	D	M	4	8	F9Q762	81814
	60	03/01 →	1.870	D	M	4	8	F9Q762	84009
2.0	88	03/01 →	1.998	B	M	4	16	F4R720	81814
	88	03/01 →	1.998	B	M	4	16	F4R720	84009
	88	03/01 →	1.998	B	M	4	16	F4R720, F4R722	81814
	88	03/01 →	1.998	B	M	4	16	F4R720, F4R722	84009
2.0 16V	86	08/06 →	1.998	B	M	4	16	F4R820	81814
	86	08/06 →	1.998	B	M	4	16	F4R820	84009
2.0 dCi 115	84	08/06 →	1.995	D	M	4	16	M9R630, M9R692, M9R780, M9R782, M9R786	82069
	84	08/06 →	1.995	D	M	4	16	M9R692, M9R780, M9R782, M9R786	82069
	84	08/06 →	1.995	D	M	4	16	M9R780, M9R782, M9R786	82069
2.0 dCi 90	66	08/06 →	1.995	D	M	4	16	M9R630, M9R780, M9R782	82069
	66	08/06 →	1.995	D	M	4	16	M9R780, M9R782	82069
	66	08/06 →	1.995	D	M	4	16	M9R782	82069
2.5 dCi	84	08/07 →	2.463	D	M	4	16	G9U630	81855
2.5 dCi 115	84	02/08 →	2.464	D	M	4	16	G9U630	81855
2.5 dCi 135	99	03/01 →	2.463	D	M	4	16	G9U730	81855
	99	05/03 →	2.464	D	M	4	16	G9U730	81855
2.5 dCi 145	107	08/06 →	2.464	D	M	4	16	G9U630	81855
2.5 DTi	99	03/03 → 07/03	2.463	D	M	4	16	G9U730	81855

**KW**

**cm<sup>3</sup>**

**NO. OF VALVES**

**RENAULT**
**Twingo I**

1.2	44	09/98 → 08/00	1.149	B	M	4	8	D7F702, D7F703, D7F704		81762
	40	05/96 →	1.149	B	M	4	8	D7F700, D7F701		81762
	43	05/96 →	1.149	B	M	4	8	D7F700, D7F701, D7F702, D7F703, D7F704		81762
	43	05/96 →	1.149	B	M	4	8	D7F700, D7F701, D7F702, D7F703, D7F704, D7F706		81762
	40	03/93 → 10/96	1.239	B	M	4	8	C3G700, C3G702	(-)COP, (-)AC	81596
	40	03/93 → 10/96	1.239	B	M	4	8	C3G700, C3G702	(+)COP, (-)AC	81854
	40	03/93 → 10/96	1.239	B	M	4	8	C3G700, C3G702	(+)COP, (+)AC	81852
1.2 16V	44	08/04 → 06/07	1.149	B	M	4	16	D4F708		81820
	55	01/01 →	1.149	B	M	4	16	D4F702		81820
1.2 LPG	44	10/03 →	1.149		M	4	8	D7F702, D7F708		82091
	44	10/03 →	1.149		M	4	8	D7F702, D7F708		81762

**Twingo II**

1.2	43	03/07 →	1.149	B	M	4	8	D7F800		82091
1.2 16V	55	03/07 →	1.149	B	M	4	16	D4F764, D4F770, D4F772		82090
	56	03/07 →	1.149	B	M	4	16	D4F772		82090
1.2 TCe 100	75	02/11 →	1.149	B	M	4	16	D4F780, D4F782		82090
1.2 Turbo	74	03/07 →	1.149	B	M	4	16	D4F780, D4F782		82090
1.5 dCi	47	03/07 →	1.461	D	M	4	8	K9K740		84007
	62	04/08 →	1.461	D	M	4	8	K9K718		81810
	62	04/08 →	1.461	D	M	4	8	K9K718		84007
1.5 dCi 75	55	10/10 →	1.461	D	M	4	8	K9K820		82098
1.5 dCi 90	63	10/10 →	1.461	D	M	4	8	K9K820		82098
1.6 RS	98	05/08 →	1.598	B	M	4	16	K4M854		84039 <b>NEW</b>
	98	05/08 →	1.598	B	M	4	16	K4M854		81806

**Twingo III**

0.9 TCe 90	66	09/14 →	898	B	M	3	12	H4B401		84003
1.0 SCe 70	52	09/14 →	999	B	M	3	12	H4D400		84003

**Vel Satis**

2.0 16V Turbo	125	04/04 →	1.998	B	M	4	16	F4R766, F4R767		81814
	125	04/04 →	1.998	B	M	4	16	F4R766, F4R767		84009
	120	06/02 →	1.998	B	M	4	16	F4R762, F4R763		81814
	120	06/02 →	1.998	B	M	4	16	F4R762, F4R763		84009
2.0 dCi	110	08/05 →	1.995	D	M	4	16	M9R760		82069
	127	01/06 →	1.995	D	M	4	16	M9R760, M9R762, M9R763		82069
2.0 Turbo	108	04/05 →	1.998	B	M	4	16	F4R867		81814
	108	04/05 →	1.998	B	M	4	16	F4R867		84009

**KW**

**cm<sup>3</sup>**

**NO. OF VALVES**

**MAGNETI MARELLI**
**RENAULT**
**Vel Satis**

2.2 dCi	83	12/04 →	2.188	D	M	4	16	G9T600		81855
	85	04/04 →	2.188	D	M	4	16	G9T600		81855
	102	09/04 →	2.188	D	M	4	16	G9T600, G9T606, G9T607, G9T700, G9T702		81855
	110	06/02 →	2.188	D	M	4	16	G9T702, G9T703		81855

**Wind**

1.2	74	07/10 →	1.149	B	M	4	16	D4F782		84024	<b>NEW</b>
1.2 TCe 100	75	02/11 →	1.149	B	M	4	16	D4F780		82090	
1.6	98	07/10 →	1.598	B	M	4	16	K4M854		84039	<b>NEW</b>
	98	07/10 →	1.598	B	M	4	16	K4M854		81806	

**ROVER**
**25**

1.1 16V	55	01/04 → 05/05	1.119	B	M	4	16	11K4F		81615
1.4 16V	62	10/99 → 05/05	1.396	B	M	4	16	14K4M		81615
	76	10/99 → 05/05	1.396	B	M	4	16	14K4F		81615
1.6 16V	80	10/99 → 05/05	1.588	B	M	4	16	16K4F		81615
1.8 16V	85	10/99 → 05/05	1.796	B	A	4	16	18K4F		81615
	107	02/00 → 05/05	1.796	B	M	4	16	18K4K		81615
2.0 iDT	74	10/99 → 05/05	1.994	D	M	4	8	20T2N		81707

**45**

1.4	76	02/00 → 05/05	1.396	B	M	4	16	14K4F		81615
1.6	80	02/00 → 05/05	1.588	B	M	4	16	16K4F		81615
1.8	86	02/00 → 05/05	1.796	B	M	4	16	18K4F		81615
2.0 iDT	74	02/00 → 05/05	1.994	D	M	4	8	20T2N		81707
2.0 V6	110	02/00 → 05/05	1.997	B	A	6	24	20K4F		82029

**75, Station Wagon**

1.8	88	02/99 → 05/05	1.796	B	M	4	16	K1.8		81615
1.8 Turbo	110	05/03 → 05/05	1.796	B	M	4	16	18K4G		81615
2.0 V6	110	02/99 → 05/05	1.997	B	M	6	24	20K4F		82029
2.5 V6	129	02/99 → 10/01	2.497	B	M	6	24	KV6		82029
	130	10/01 → 05/05	2.497	B	M	6	24	25K4F		82029
	130	08/01 → 05/05	2.497	B	M	6	24	KV6		82029

**100**

111	44	04/94 → 10/97	1.119	B	M	4	8	11K2D		81614
114	55	04/94 → 10/97	1.396	B	M	4	8	14K2A, 14K2D		81614
	75	03/97 → 10/98	1.396	B	M	4	16	14K4F		81615

**100 (Metro)**

111 C/L/S	44	03/90 → 12/98	1.119	B	M	4	8	11K2A, 11K2D		81614
114 D	38	10/92 → 12/94	1.361	D	M	4	8	TUD3		81556
114 GSi	76	10/94 → 10/95	1.396	B	M	4	16	14K4F		81615
114 GTI 16V	69	03/90 → 08/91	1.396	B	M	4	16	14K4C, 14K4D		81615
	76	08/91 → 12/98	1.396	B	M	4	16	14K4F		81615

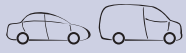

KW



cm<sup>3</sup>



NO. OF  
VALVES



MAGNETI  
MARELLI

## ROVER

### 100 (Metro)

114 GTI/GT 16V Cat.	66	03/90 → 12/98	1.396	B	M	4	16	14K4C, 14K4D		81615
114 Si/L/GTA	55	03/90 → 12/98	1.396	B	M	4	8	14K2A, 14K2D		81614
115 D	42	12/94 → 12/98	1.527	D	M	4	8	TUD5		81556

### 200 II, Coupé

2.0	152	10/92 → 09/97	1.994	B	M	4	16			81707
214	55	09/93 → 10/95	1.396	B	M	4	8	14K2A, 14K2D		81614
214 GSi/Si	70	01/90 → 10/95	1.396	B	M	4	16	14K4C		81615
	76	12/92 → 10/95	1.396	B	M	4	16	14K4F		81615
214 Si/Gsi	66	10/89 → 10/95	1.396	B	M	4	16	14K4C, 14K4D		81615
216	90	10/92 → 06/99	1.590	B	M	4	16	D16A8		81613
216 GSi	82	10/89 → 10/95	1.590	B	M	4	16	D16Z2		81613
	85	10/89 → 10/95	1.590	B	M	4	16	D16A7		81613
216 GTi	90	09/90 → 10/95	1.590	B	M	4	16	D16A8		81613
	96	09/90 → 10/95	1.590	B	M	4	16	D16A9		81613
218 D	52	09/91 → 10/95	1.905	D	M	4	8	XUD9		81672
218 TD	65	09/91 → 10/95	1.769	D	M	4	8	XUD7TE		81672
220 GSi	100	05/94 → 06/99	1.994	B	M	4	16	20T4H		81707
220 GTi	100	01/93 → 10/95	1.994	B	M	4	16	20T4H		81707
	103	09/91 → 10/95	1.994	B	M	4	16	20M4F		81707
220 Turbo	147	01/93 → 10/95	1.994	B	M	4	16	20T4G		81707

### 200 III

211	44	01/98 → 03/00	1.119	B	M	4	8	11K2D		81614
214 i	55	11/95 → 03/00	1.396	B	M	4	8	14K2F	03-1996 →	81614
214 Si	76	11/95 → 03/00	1.396	B	M	4	16	14K4F		81615
216 Si	82	11/95 → 03/00	1.588	B	M	4	16	16K4F		81615
218 K Vi	107	11/95 → 03/00	1.796	B	M	4	16	18K4K		81615
220 D/SD	63	11/95 → 03/00	1.994	D	M	4	8	20T2R		81707
220 SDi	77	11/95 → 03/00	1.994	D	M	4	8	20T2N		81707

### 400 I, Station Wagon

1.6 i	82	05/94 → 11/98	1.590	B	M	4	16	D16Z2	→ 02-1996	81613
	82	05/94 → 11/98	1.590	B	M	4	16	D16Z2	03-1996 →	81615
	90	05/94 → 11/98	1.590	B	M	4	16	D16A8	→ 02-1996	81613
	90	05/94 → 11/98	1.590	B	M	4	16	D16A8	03-1996 →	81615
1.8 i	107	06/96 → 11/98	1.796	B	M	4	16	18K4K		81615
1.8 TD	65	09/93 → 11/98	1.769	D	M	4	8	XUD7TE		81672
2.0 i	100	05/94 → 11/98	1.994	B	M	4	16	20T4H		81707
2.0 Turbo GSi Sport	152	10/92 → 04/95	1.994	B	M	4	16			81707
414	70	01/93 → 04/95	1.396	B	M	4	16	14K4C		81615
414 GSi/Si	66	04/90 → 04/95	1.396	B	M	4	16	14K4C, 14K4D		81615
414 GSi/Si Cat.	76	01/93 → 04/95	1.396	B	M	4	16	14K4F		81615
416 GSi	82	04/90 → 04/95	1.590	B	M	4	16	D16Z2		81613
416 GSi/GSE	85	04/90 → 04/95	1.590	B	M	4	16	D16A7		81613
416 GTi	90	04/90 → 04/95	1.590	B	M	4	16	D16A8		81613
416 GTi/GTE	96	04/90 → 04/95	1.590	B	M	4	16	D16A9		81613

**KW**

**cm<sup>3</sup>**

**NO. OF VALVES**

**ROVER**
**400 I, Station Wagon**

418 D	49	09/91 → 04/95	1.905	D	M	4	8	XUD9		81672
418 TD	65	09/91 → 04/95	1.769	D	M	4	8	XUD7TE		81672
420 GSI/SLI/GTI/Vite	100	01/93 → 04/95	1.994	B	M	4	16	20T4H		81707
420 GTI/GSI/Vitesse	103	02/92 → 04/95	1.994	B	M	4	16	20M4F	→ 09-1992	81843
	103	02/92 → 04/95	1.994	B	M	4	16	20M4F	10-1992 →	81707
420 Turbo	147	01/93 → 04/95	1.994	B	M	4	16	20T4G		81707

**400 II**

414 Si	76	05/95 → 03/00	1.396	B	M	4	16	14K4F		81615
416 Si	82	05/95 → 03/00	1.588	B	M	4	16	16K4F		81615
	83	05/95 → 03/00	1.590	B	A	4	16	D16Y2		81615
420 D	63	11/95 → 03/00	1.994	D	M	4	8	20T2R		81707
420 Di	77	05/95 → 03/00	1.994	D	M	4	8	20T2N		81707
420 Si Lux	100	12/95 → 03/00	1.994	B	M	4	16	20T4H		81707

**600**

618 i/Si	85	03/96 → 02/99	1.850	B	M	4	16	F18A3		81708
620 i	85	08/93 → 06/96	1.997	B	M	4	16	F20Z2		81708
620 Sdi	77	12/94 → 02/99	1.994	D	M	4	8	20T2N		81707
620 Si	96	08/93 → 02/99	1.997	B	M	4	16	F20Z1		81708
620 Ti Vitesse	147	07/94 → 02/99	1.994	B	M	4	16	20T4G		81707
623 Si	116	08/93 → 02/99	2.259	B	M	4	16	H23A3		81709

**800**

2.0 E	84	10/88 → 10/91	1.994	B	M	4	16		→ T: 200.604	81843
2.0 Turbo	120	10/88 → 10/91	1.994	B	M	4	16		→ T: 200.604	81843
820	74	10/88 → 10/91	1.994	B	M	4	8		→ T: 200.604	81843
820 16V Turbo	132	01/92 → 02/99	1.996	B	M	4	16	T16		81707
820 i/Si	103	10/88 → 12/91	1.994	B	M	4	16	20HD	→ T: 200.604	81843
	100	01/92 → 02/99	1.996	B	M	4	16	20T4H		81707
820 SE/SI	88	10/86 → 12/91	1.994	B	M	4	8	20HS	→ T: 200.604	81843
820 SI	98	10/88 → 12/91	1.994	B	M	4	16	20HDM16	→ T: 200.604	81843
820 Sport	145	04/94 → 03/96	1.994	B	M	4	16	20T4G		81707
820e	88	10/86 → 10/91	1.994	B	M	4	8	20HS	→ T: 200.604	81843
825 D/SD	87	01/90 → 02/99	2.500	D	M	4	8	425SL1RR, 4924SHIRG	(-)COP, 03-1996 →	81362
	87	01/90 → 02/99	2.500	D	M	4	8	425SL1RR, 4924SHIRG	→ 02-1996	81302
825 SD	87	09/93 → 02/99	2.500	D	M	4	8	425SL1RR, 4924SHIRG	(-)COP, 03-1996 →	81362
	87	09/93 → 02/99	2.500	D	M	4	8	425SL1RR, 4924SHIRG	→ 02-1996	81302
825 Si	129	04/96 → 02/99	2.497	B	M	6	24	25K4F		81302

**KW**

**cm<sup>3</sup>**

**NO. OF VALVES**

**ROVER**
**Cabriolet**

214 1.4	66	01/92 → 11/99	1.396	B	M	4	16	14K4C, 14K4D		81615
	70	04/90 → 09/92	1.396	B	M	4	16	14K4C		81615
214 1.4i 16V	76	01/93 → 11/99	1.396	B	M	4	16	14K4F		81615
216 1.6i	90	01/92 → 11/99	1.590	B	M	4	16	D16A8		81613
216 1.6i 16V	82	01/96 → 11/99	1.588	B	M	4	16	16K4F		81613

**Coupé**

1.6 16 V	82	03/96 → 11/99	1.588	B	M	4	16	16K4F		81615
1.8 16 V	107	03/96 → 11/99	1.795	B	M	4	16	18K4K		81615

**Mini, Cabrio**

1000	30	01/92 → 06/93	999	B	M	4	8	99HD81	BC	81419
1300	37	10/92 → 11/00	1.273	B	M	4	8	12A2B	BC	81419
	39	01/92 → 04/95	1.273	B	M	4	8	12A2D	BC	81419
	45	01/91 → 12/91	1.273	B	M	4	8	12A2A	BC	81419
	46	09/92 → 04/95	1.273	B	M	4	8	12A2E	BC	81419
	46	01/92 → 11/00	1.275	B	M	4	8	12A2E, 12A2L	BC	81419

**Streetwise**

1.4	62	08/03 → 05/05	1.396	B	M	4	16	14K4M		81615
	76	08/03 → 05/05	1.396	B	M	4	16	14K4F		81615
2.0 TD	74	08/03 → 05/05	1.994	D	M	4	8	20T2N		81707

**SAAB**
**9-3 I, Cabrio**

2.0 i	96	02/98 → 09/02	1.985	B	M	4	16	B204I		81764
2.0 SE Turbo	147	02/98 → 09/02	1.985	B	M	4	16	B204R		81764
2.0 Turbo	110	01/01 → 09/02	1.985	B	M	4	16	B205E		81764
	113	10/98 → 09/02	1.985	B	M	4	16	B204E		81764
	136	02/98 → 09/02	1.985	B	M	4	16	B204L, B205E, B205L		81764
	151	10/99 → 09/02	1.985	B	M	4	16	B205R		81764
2.2 TiD	85	02/98 → 11/00	2.171	D	M	4	16	D223L, X22DTH		81747
	92	11/00 → 09/02	2.171	D	M	4	16	D223L		81747
2.3	169	09/99 → 01/02	2.290	B	M	4	16	B235R		81764
2.3 i	110	02/98 → 09/02	2.290	B	M	4	16	B234I		81764
2.3 Turbo	165	10/98 → 09/02	2.290	B	M	4	16	B235R		81764

**9-3 II, Station Wagon, Cabrio**

1,8t	110	09/02 →	1.998	B	M	4	16	B207E		81812
1,8t BioPower	110	01/07 →	1.998		M	4	16	B207E		81812
	129	05/09 →	1.998		M	4	16	B207L		81812
1.8 i	90	01/04 →	1.796	B	M	4	16	Z18XE		81751
1.8t 2.0	110	03/05 →	1.998	B	M	4	16	B207E		81812
1.9 TiD	88	09/04 →	1.910	D	M	4	8	Z19DT		81352
	110	09/04 →	1.910	D	M	4	16	Z19DTH		81872
1.9 TTiD	132	12/07 →	1.910	D	M	4	16	A19DTR, Z19DTR		81872
	132	12/07 →	1.910	D	M	4	16	Z19DTR		81872



**KW**

**cm<sup>3</sup>**

**NO. OF VALVES**

**SAAB**
**9-3 II, Station Wagon, Cabrio**

2.0 t	110	03/05 →	1.998	B	M	4	16	B207E		81812
	129	08/03 →	1.998	B	M	4	16	B207L		81812
	129	09/02 →	1.998	B	M	4	16	B207L, B207M		81812
	147	02/09 →	1.998	B	M	4	16	B207M		81812
	154	09/02 →	1.998	B	M	4	16	B207R		81812
	177	05/09 →	1.998	B	M	4	16	B207R		81812
2.0 t BioPower	110	01/07 →	1.998		M	4	16	B207E		81812
	129	01/07 →	1.998		M	4	16	B207L		81812
	145	06/07 →	1.998		M	4	16	B207R		81812
	147	05/09 →	1.998		M	4	16	B207M		81812
	154	09/02 →	1.998		M	4	16	B207R		81812
2.0 t XWD	154	06/08 →	1.998	B	M	4	16	B207R		81812
2.0 Turbo XWD	154	01/08 →	1.998	B	M	4	16	B207R		81812
2.2 TiD	92	09/02 →	2.171	D	M	4	16	D223L		81747
2.8 Turbo V6	184	03/05 →	2.792	B	M	6	24	LP9		84057
	188	12/07 →	2.792	B	M	6	24	B284L		84057
	203	04/08 →	2.792	B	M	6	24	B284L		84057
	203	02/09 →	2.792	B	M	6	24	B284R		84057
	206	02/09 →	2.792	B	M	6	24	B284R		84057
2.8 Turbo V6 XWD	206	05/08 →	2.792	B	M	6	24	B284R		84057

**9-3 X**

1.9 TTiD	132	02/09 →	1.910	D	M	4	16	A19DTR, Z19DTR		81872
2.0 t BioPower XWD	154	02/09 →	1.998		M	4	16	B207R		81812
2.0 t XWD	154	02/09 →	1.998	B	M	4	16	B207R		81812

**9-5 I, Station Wagon**

1.9 TiD	110	01/06 → 12/09	1.910	D	M	4	16	Z19DTH		81872
2.0 t	110	09/97 → 12/09	1.985	B	M	4	16	B205E		81764
	136	07/00 → 12/09	1.985	B	M	4	16	B205L		81764
	141	10/98 → 12/09	1.985	B	M	4	16	B204R		81764
2.0 t Biopower	132	09/05 → 12/09	1.985		M	4	16	B205E		81764
2.0 Turbo SE	141	10/98 → 07/00	1.985	B	M	4	16	B205E		81764
2.2 TiD	88	03/02 → 12/09	2.171	D	M	4	16	D223L		81747
2.3 t	125	09/97 → 12/09	2.290	B	M	4	16	B235E		81764
	136	01/01 → 12/09	2.290	B	M	4	16	B235E		81764
2.3 Turbo	162	07/03 → 12/09	2.290	B	M	4	16	B235L		81764
	169	10/99 → 09/01	2.290	B	M	4	16	B235R		81764
	184	09/01 → 12/09	2.290	B	M	4	16	B235R		81764
	191	11/05 → 12/09	2.290	B	M	4	16	B235R		81764
	224	06/03 → 08/05	2.290	B	M	4	16	B235R		81764
3.0 V6t	147	01/98 → 12/09	2.962	B	A	6	24	B308E		81846

**KW**

**cm<sup>3</sup>**

**NO. OF VALVES**

## SAAB

### 9-5 II, Station Wagon

1.6 Turbo	132	05/10 → 01/12	1.598	B	M	4	16	A16LET		82083
2.0 t BioPower	162	05/10 → 01/12	1.998		M	4	16	A20NFT		81812
2.0 t BioPower XWD	162	05/10 → 01/12	1.998		M	4	16	A20NHT		81812
2.0 TiD	118	05/10 → 01/12	1.956	D	M	4	16	A20DTH		81872
2.0 TTiD	140	05/10 → 01/12	1.956	D	M	4	16	A20DTR		81872
2.0 TTiD XWD	140	05/10 → 01/12	1.956	D	M	4	16	A20DTR		81872
2.0 Turbo	162	05/10 → 01/12	1.998	B	M	4	16	A20NHT		81812
2.0 Turbo XWD	162	05/10 → 01/12	1.998	B	M	4	16	A20NHT		81812
2.8 Turbo V6 XWD	221	05/10 → 01/12	2.792	B	M	6	24	A28NER		84057 <b>NEW</b>

### 900 II, Cabrio, Coupé

2.0 -16 Turbo	136	07/93 → 02/98	1.985	B	M	4	16	B204L		81764
2.0 i	96	08/94 → 02/98	1.985	B	M	4	16	B204I		81764
	98	07/93 → 07/94	1.985	B	M	4	16	B206I		81764
2.3 -16	110	07/93 → 02/98	2.290	B	M	4	16	B234I		81764
2.5 -24 V6	125	07/93 → 02/98	2.498	B	M	6	24	B258I		81846

### 9000

3.0 -24 V6 CD/CDE	155	07/94 → 12/98	2.962	B	M	6	24	B308I		81846
	155	07/94 → 12/98	2.962	B	M	6	24	B308I		81846

## SEAT

### Alhambra I

1.8 T 20V	110	10/97 → 03/10	1.781	B	M	4	20	AJH, AWC		81703
1.9 TDI	66	04/96 → 03/10	1.896	D	M	4	8	1Z, AHU, ANU	(-)COP, → 07-2000	81522
	66	04/96 → 03/10	1.896	D	M	4	8	1Z, AHU, ANU	(+)COP	82080
	66	04/96 → 03/10	1.896	D	M	4	8	1Z, AHU, ANU	(+)COP, → 07-2000	82080
	66	04/96 → 03/10	1.896	D	M	4	8	1Z, AHU, ANU	08-2000 →	81816
	66	04/96 → 03/10	1.896	D	M	4	8	1Z, AHU, ANU		84011 <b>NEW</b>
	81	08/96 → 06/00	1.896	D	M	4	8	AFN, AVG	(-)COP	81522
	81	08/96 → 06/00	1.896	D	M	4	8	AFN, AVG	(+)COP	82080
	85	06/00 → 03/10	1.896	D	M	4	8	AUY, BVK		81816
	85	06/00 → 03/10	1.896	D	M	4	8	AUY, BVK		84011 <b>NEW</b>
	96	11/02 → 11/08	1.896	D	M	4	8	ASZ		84010 <b>NEW</b>
	96	11/02 → 11/08	1.896	D	M	4	8	ASZ		81791
	110	05/05 → 05/07	1.896	D	M	4	8	BTB		81816
110	05/05 → 05/07	1.896	D	M	4	8	BTB		84011 <b>NEW</b>	
1.9 TDI 4motion	85	06/00 → 03/10	1.896	D	M	4	8	AUY, BVK		81816
	85	06/00 → 03/10	1.896	D	M	4	8	AUY, BVK		84011 <b>NEW</b>
1.9 Tdi 4x4	96	06/05 → 11/08	1.896	D	M	4	8	ASZ		84010 <b>NEW</b>
	96	06/05 → 11/08	1.896	D	M	4	8	ASZ		81791

		<b>KW</b>		<b>cm<sup>3</sup></b>				<b>NO. OF VALVES</b>		
--	--	-----------	--	-----------------------	--	--	--	----------------------	--	--

## SEAT

### Alhambra I

2.0 i	85	04/96 → 03/10	1.984	B	AM	4	8	ADY, ATM	(-)COP, → 07-2000, M: ADY	81522
	85	04/96 → 03/10	1.984	B	AM	4	8	ADY, ATM	(+)COP	82080
	85	04/96 → 03/10	1.984	B	AM	4	8	ADY, ATM	(+)COP, → 07-2000, M: ADY	82080
	85	04/96 → 03/10	1.984	B	AM	4	8	ADY, ATM	08-2000 →, M: ATM	81703
2.0 TDI	103	11/05 → 03/10	1.968	D	M	4	8	BRT		81816
	103	11/05 → 03/10	1.968	D	M	4	8	BRT		84011 <b>NEW</b>
2.8 V6	150	06/00 → 03/10	2.792	B	M	6	24	AUE, AYL		81866
2.8 V6 4motion	150	06/00 → 03/10	2.792	B	M	6	24	AUE, AYL		81866

### Alhambra II

1.4 TSI	110	05/15 →	1.395	B	M	4	16	CZDA		84062 <b>NEW</b>
2.0 TDI	85	05/11 →	1.968	D	M	4	16	CFFE		84001
	100	06/10 → 05/11	1.968	D	M	4	16	CFFA		84001
	103	06/10 →	1.968	D	M	4	16	CFFB		84001
	125	06/10 →	1.968	D	M	4	16	CFGB		84001
	130	11/12 →	1.968	D	M	4	16	CFGC		84001
2.0 TDI 4Drive	103	05/11 →	1.968	D	M	4	16	CFFB		84001
2.0 TSI	147	11/10 →	1.984	B	M	4	16	CCZA		84016 <b>NEW</b>
	162	05/15 →	1.984	B	M	4	16	DEDA		84037 <b>NEW</b>

### Altea, Altea XL

1.2 TSI	77	04/10 →	1.197	B	M	4	8	CBZB		84045 <b>NEW</b>
1.4 16V	63	05/06 →	1.390	B	M	4	16	BXW, CGGB		81777
1.4 TSI	92	11/07 →	1.390	B	M	4	16	CAXC		82097
1.6	75	03/04 →	1.595	B	M	4	8	BGU, BSE, BSF, CCSA, CMXA		81702
	75	10/06 →	1.595	B	M	4	8	BSE, BSF, CCSA, CMXA		81702
1.6 LPG	75	09/09 →	1.595		M	4	8	CHGA		81702
1.6 Multifuel	75	10/06 →	1.595		M	4	8	CCSA		81702
1.6 TDI	66	11/10 →	1.598	D	M	4	16	CAYB		84001
	77	10/09 →	1.598	D	M	4	16	CAYC		84001
1.8 TFSI	118	01/07 →	1.798	B	M	4	16	BYT, BZB, CDAA	→ 05-2007, → T: 5P7084000	84016 <b>NEW</b>
	118	01/07 →	1.798	B	M	4	16	BYT, BZB, CDAA	06-2007 →, → 05-2007, T →: 5P7084001, → T: 5P7084000	84016 <b>NEW</b>
1.9 TDI	66	08/09 →	1.896	D	M	4	8	BXF		84010 <b>NEW</b>
	66	08/09 →	1.896	D	M	4	8	BXF		81791
	77	04/04 →	1.896	D	M	4	8	BJB, BKC, BLS, BXE		84010 <b>NEW</b>
	77	04/04 →	1.896	D	M	4	8	BJB, BKC, BLS, BXE		81791
	77	10/06 →	1.896	D	M	4	8	BKC, BLS, BXE		84010 <b>NEW</b>
	77	10/06 →	1.896	D	M	4	8	BKC, BLS, BXE		81791

**KW**

**cm<sup>3</sup>**

**NO. OF VALVES**

**MAGNETI MARELLI**
**SEAT**
**Altea, Altea XL**

2.0 FSI	110	05/04 → 03/09	1.984	B	M	4	16	BLR, BLY, BVY, BVZ		81702
	110	10/06 → 03/09	1.984	B	M	4	16	BVY, BVZ		81702
2.0 TDI	100	03/04 → 05/09	1.968	D	M	4	16	AZV		81816
	100	03/04 → 05/09	1.968	D	M	4	16	AZV		84011 <b>NEW</b>
	103	11/05 →	1.968	D	M	4	8	BMM		81816
	103	11/05 →	1.968	D	M	4	8	BMM		84011 <b>NEW</b>
	125	03/06 →	1.968	D	M	4	16	BMN, CEGA		81816
2.0 TDI 16V	103	03/04 →	1.968	D	M	4	16	BKD, CFHC		81816
	103	03/04 →	1.968	D	M	4	16	BKD, CFHC		84011 <b>NEW</b>
2.0 TDI 16V 4x4	103	10/10 →	1.968	D	M	4	16	CFHC		84001
2.0 TDI 4x4	103	06/07 →	1.968	D	M	4	8	BMM		81816
	103	06/07 →	1.968	D	M	4	8	BMM		84011 <b>NEW</b>
	125	06/07 →	1.968	D	M	4	16	BMN, CEGA, CFJA		81816
	125	06/07 →	1.968	D	M	4	16	BMN, CEGA, CFJA		84011 <b>NEW</b>
2.0 TFSI	147	04/06 → 05/09	1.984	B	M	4	16	BWA		82025
2.0 TFSI 4x4	147	06/07 → 05/09	1.984	B	M	4	16	BWA		82025
	155	05/09 →	1.984	B	M	4	16	CCZB		84016 <b>NEW</b>

**Arosa**

1.0	37	10/98 → 01/01	997	B	M	4	8	AHT		81807
	37	05/97 → 06/04	999	B	M	4	8	AER, ALD, ALL, ANV, AUC	→ 11-1999, M: AHT	81807
	37	05/97 → 06/04	999	B	M	4	8	AER, ALD, ALL, ANV, AUC	M: ALD, M: AER, M: ALL, M: ALD, M: AUC, M: AER	81775
1.4	44	05/97 → 06/04	1.390	B	AM	4	8	AEX, AKK, AKV, ANW, APQ, AUD	→ 11-1999	81527
	44	05/97 → 06/04	1.390	B	AM	4	8	AEX, AKK, AKV, ANW, APQ, AUD	12-1999 →, M: AUD, M: ANW, M: AUD	81775
1.4 16V	74	01/00 → 06/04	1.390	B	M	4	16	AFK, AQQ, AUB		81777
1.4 TDI	55	01/00 → 06/04	1.422	D	M	3	6	AMF		84010 <b>NEW</b>
	55	01/00 → 06/04	1.422	D	M	3	6	AMF		81791
1.7 SDI	44	08/97 → 06/04	1.716	D	M	4	8	AKU		81528

**Cordoba I, Vario**

1.0 i	37	09/96 → 06/99	999	B	M	4	8	AER		81775
1.4 i	44	06/94 → 06/99	1.390	B	M	4	8	ABD, AEX, AKV, APQ	→ 05-1996	81524
	44	06/94 → 06/99	1.390	B	M	4	8	ABD, AEX, AKV, APQ	06-1996 →	81527
	44	09/96 → 06/99	1.390	B	M	4	8	AEX, AKV, APQ	05-1997 →	81527
1.4 i 16V	74	09/96 → 06/99	1.390	B	M	4	16	AFH		81776



KW



cm<sup>3</sup>



NO. OF VALVES



**SEAT**

**Cordoba I, Vario**

1.6 i	55	05/94 → 06/99	1.595	B	M	4	8	1F	(-)COP	81522
	55	05/94 → 06/99	1.595	B	M	4	8	1F	(+)COP	82080
	74	09/96 → 06/99	1.595	B	M	4	8	AFT	(-)COP	81522
	74	09/96 → 06/99	1.595	B	M	4	8	AFT	(+)COP	82080
	74	07/96 → 10/99	1.595	B	M	4	8	AFT, AKL	(-)COP	81522
	74	07/96 → 10/99	1.595	B	M	4	8	AFT, AKL	(+)COP	82080
	55	02/93 → 06/99	1.598	B	M	4	8	ABU, AEE, ALM		81524
	55	09/96 → 06/99	1.598	B	M	4	8	AEE, ALM	(-)COP	81522
	55	09/96 → 06/99	1.598	B	M	4	8	AEE, ALM	(+)COP	82080
1.8 i	66	02/93 → 06/99	1.781	B	M	4	8	ABS, ACC, ADZ	(-)COP, 10-1993 →	81522
	66	02/93 → 06/99	1.781	B	M	4	8	ABS, ACC, ADZ	(+)COP	82080
	66	02/93 → 06/99	1.781	B	M	4	8	ABS, ACC, ADZ	(+)COP, 10-1993 →	82080
1.8 i 16V	95	10/93 → 08/96	1.781	B	M	4	16	ADL	(-)COP, 10-1993 →	81522
	95	10/93 → 08/96	1.781	B	M	4	16	ADL	(+)COP	82080
	95	10/93 → 08/96	1.781	B	M	4	16	ADL	(+)COP, 10-1993 →	82080
1.9 D	47	01/96 → 08/96	1.896	D	M	4	8	1Y	(-)COP, 06-1996 →	81522
	47	01/96 → 08/96	1.896	D	M	4	8	1Y	(+)COP	82080
	47	01/96 → 08/96	1.896	D	M	4	8	1Y	(+)COP, 06-1996 →	82080
	50	02/93 → 08/96	1.896	D	M	4	8	1Y	(-)COP, 10-1993 →	81522
	50	02/93 → 08/96	1.896	D	M	4	8	1Y	(+)COP	82080
	50	02/93 → 08/96	1.896	D	M	4	8	1Y	(+)COP, 10-1993 →	82080
1.9 SDI	47	08/96 → 06/99	1.896	D	M	4	8	AEY	(-)COP, 05-1997 →	81522
	47	08/96 → 06/99	1.896	D	M	4	8	AEY	(+)COP	82080
	47	08/96 → 06/99	1.896	D	M	4	8	AEY	(+)COP, 05-1997 →	82080
	47	09/96 → 06/99	1.896	D	M	4	8	AEY	(-)COP	81522
1.9 TD	55	02/93 → 08/96	1.896	D	M	4	8	AAZ	(-)COP, 10-1993 →	81522
	55	02/93 → 08/96	1.896	D	M	4	8	AAZ	(+)COP	82080
	55	02/93 → 08/96	1.896	D	M	4	8	AAZ	(+)COP, 10-1993 →	82080
1.9 TDI	66	08/96 → 06/99	1.896	D	M	4	8	1Z, AHU	(-)COP	81522
	66	08/96 → 06/99	1.896	D	M	4	8	1Z, AHU	(-)COP, 06-1996 →	81522
	66	08/96 → 06/99	1.896	D	M	4	8	1Z, AHU	(+)COP	82080
	66	08/96 → 06/99	1.896	D	M	4	8	1Z, AHU	(+)COP, 06-1996 →	82080
	81	03/97 → 06/99	1.896	D	M	4	8	AFN	(-)COP, 05-1997 →	81522
	81	03/97 → 06/99	1.896	D	M	4	8	AFN	(+)COP	82080
	81	03/97 → 06/99	1.896	D	M	4	8	AFN	(+)COP, 05-1997 →	82080
	81	07/97 → 06/99	1.896	D	M	4	8	AFN	(-)COP	81522
2.0 i	85	02/93 → 06/99	1.984	B	M	4	8	2E, AGG	(-)COP, 10-1993 →	81522
	85	02/93 → 06/99	1.984	B	M	4	8	2E, AGG	(+)COP	82080
	85	02/93 → 06/99	1.984	B	M	4	8	2E, AGG	(+)COP, 10-1993 →	82080
2.0 i 16V	110	08/96 → 06/99	1.984	B	M	4	16	ABF	(-)COP, 02-1997 →	81522
	110	08/96 → 06/99	1.984	B	M	4	16	ABF	(+)COP	82080
	110	08/96 → 06/99	1.984	B	M	4	16	ABF	(+)COP, 02-1997 →	82080

**KW**

**cm<sup>3</sup>**

**NO. OF VALVES**

**MAGNETI MARELLI**
**SEAT**
**Cordoba II, Vario**

1.0	37	06/99 → 10/02	999	B	M	4	8	ALD, ANV, AUC	81775
1.4	44	06/99 → 10/02	1.390	B	M	4	8	AKK, ANW, AUD	81775
1.4 16V	55	05/00 → 10/02	1.390	B	M	4	16	APE, AUA	81777
	74	02/00 → 10/02	1.390	B	M	4	16	AQQ, AUB	81777
1.6	74	06/99 → 10/02	1.595	B	M	4	8	AEH, AKL, APF, AUR	81702
	55	06/99 → 12/02	1.598	B	M	4	8	ABU, ALM	81527
	55	06/99 → 10/02	1.598	B	M	4	8	ALM	81527
1.8 T 20V Cupra	115	07/00 → 10/02	1.781	B	M	4	20	AQX, AYP	81703
1.9 SDI	50	06/99 → 10/02	1.896	D	M	4	8	AGP, AQM	81706
1.9 TDI	66	06/99 → 10/02	1.896	D	M	4	8	AGR, AHU, ALH	81706
	66	06/99 → 12/02	1.896	D	M	4	8	AGR, ALH	81706
	81	06/99 → 10/02	1.896	D	M	4	8	ASK, ASV	81706

**Cordoba III, Vario**

1.2	47	10/02 → 06/06	1.198	B	M	3	12	AZQ, BME	81867
1.2 12V	51	05/06 → 11/09	1.198	B	M	3	12	BXV	81867
1.4 16V	55	09/02 → 12/07	1.390	B	AM	4	16	BBY, BKY	81777
	63	05/06 → 11/09	1.390	B	M	4	16	BXW	81777
	74	10/02 → 11/09	1.390	B	M	4	16	AUB, BBZ	81777
1.4 TDI	51	05/05 → 11/09	1.422	D	M	3	6	BNM	84010 <b>NEW</b>
	51	05/05 → 11/09	1.422	D	M	3	6	BNM	81791
	55	10/02 → 12/05	1.422	D	M	3	6	AMF	84010 <b>NEW</b>
	55	10/02 → 12/05	1.422	D	M	3	6	AMF	81791
	59	06/05 → 11/09	1.422	D	M	3	6	BMS, BNV	84010 <b>NEW</b>
	59	06/05 → 11/09	1.422	D	M	3	6	BMS, BNV	81791
1.6	74	04/03 → 11/09	1.598	B	M	4	8	BAH	81527
1.6 16V	77	11/06 → 11/09	1.598	B	M	4	16	BTS	81865
1.9 SDI	47	09/02 → 11/09	1.896	D	M	4	8	ASY	82013
	74	09/02 → 11/09	1.896	D	M	4	8	ATD, AXR, BMT	84010 <b>NEW</b>
	74	09/02 → 11/09	1.896	D	M	4	8	ATD, AXR, BMT	81791
	96	10/02 → 11/09	1.896	D	M	4	8	ASZ, BLT	84010 <b>NEW</b>
	96	10/02 → 11/09	1.896	D	M	4	8	ASZ, BLT	81791
2.0	85	09/02 → 11/09	1.984	B	M	4	8	AZL, BBX	81703

**Exeo, Exeo ST**

1.6	75	03/09 → 09/10	1.595	B	M	4	8	ALZ	81702
1.8 T	110	12/08 → 05/10	1.781	B	M	4	20	CFMA	81702
1.8 TSI	88	09/10 →	1.798	B	M	4	16	CDHA	84016 <b>NEW</b>
	118	05/10 →	1.798	B	M	4	16	CDHB	84016 <b>NEW</b>
2.0 TDI	88	12/08 →	1.968	D	M	4	16	CAGC, CJCC	81816
	88	12/08 →	1.968	D	M	4	16	CAGC, CJCC	84011 <b>NEW</b>
	105	12/08 →	1.968	D	M	4	16	CAGA, CJCA	81816
	105	12/08 →	1.968	D	M	4	16	CAGA, CJCA	84011 <b>NEW</b>
	125	02/09 →	1.968	D	M	4	16	CAHA, CGLB	81816
	125	02/09 →	1.968	D	M	4	16	CAHA, CGLB	84011 <b>NEW</b>

**KW**

**cm<sup>3</sup>**

**NO. OF VALVES**

**SEAT**
**Exeo, Exeo ST**

2.0 TFSI	147	03/09 →	1.984	B	M	4	16	BWE		82025
	155	05/10 →	1.984	B	M	4	16	CDND		84016 <b>NEW</b>

**Ibiza I**

0.9	29	08/90 → 05/93	903	B	M	4	8	09NCA, 146A000		81415
	32	08/86 → 05/93	903	B	M	4	8	146A000	09-1984 →, → 12-1992	81415
1.2	44	11/84 → 12/93	1.193	B	M	4	8	021A1000		81498
	46	11/84 → 12/93	1.193	B	M	4	8	021A1000		81498
1.2 i	52	01/89 → 05/93	1.193	B	M	4	8	021C.1000		81498
1.5	63	11/84 → 05/93	1.461	B	M	4	8	021A2000		81498
1.5 i	65	10/86 → 05/93	1.461	B	M	4	8	021D.2000		81498
	74	10/86 → 05/93	1.461	B	M	4	8	021B.2000		81498
1.5 i Cat.	66	10/86 → 05/93	1.461	B	M	4	8	021C.2000		81498
1.7	72	01/91 → 05/93	1.675	B	M	4	8	021A.3000		81498
	76	01/91 → 05/93	1.675	B	M	4	8	021B.3000		81498
1.7 D	40	06/84 → 05/93	1.714	D	M	4	8	022A.5000	(+)COP, 01-1990 →	81497
	42	08/90 → 05/93	1.714	D	M	4	8	022A.5000	(+)COP, 01-1990 →, → 12-1993	81497

**Ibiza II**

1.0	33	03/93 → 09/96	1.043	B	M	4	8	AAU		81524
1.0 i	37	09/96 → 08/99	999	B	M	4	8	AER		81775
1.3 i	40	03/93 → 08/99	1.272	B	M	4	8	2G, AAV		81524
1.4	40	12/97 → 04/99	1.390	B	M	4	8	ANX		81527
1.4 i	44	09/93 → 08/99	1.390	B	M	4	8	ABD, AEX, AKV, APQ	→ 07-1996, M: ABD	81524
	44	09/93 → 08/99	1.390	B	M	4	8	ABD, AEX, AKV, APQ	08-1996 →, M: AEX	81527
1.4 i 16V	74	06/97 → 08/99	1.390	B	M	4	16	AFH		81527
1.6 i	55	09/94 → 06/99	1.595	B	M	4	8	1F	(-)COP	81522
	55	09/94 → 06/99	1.595	B	M	4	8	1F	(+)COP	82080
	74	04/96 → 08/99	1.595	B	M	4	8	AFT	(-)COP	81522
	74	04/96 → 08/99	1.595	B	M	4	8	AFT	(+)COP	82080
	55	03/93 → 08/99	1.598	B	M	4	8	ABU, AEE, ALM	(-)COP, 01-1995 →, M: AEE	81522
	55	03/93 → 08/99	1.598	B	M	4	8	ABU, AEE, ALM	(+)COP	82080
	55	03/93 → 08/99	1.598	B	M	4	8	ABU, AEE, ALM	(+)COP, 01-1995 →, M: AEE	82080
	55	03/93 → 08/99	1.598	B	M	4	8	ABU, AEE, ALM	→ 12-1994, M: ABU	81524
1.8 i	66	03/93 → 08/99	1.781	B	M	4	8	ABS, ACC, ADZ	(-)COP, 01-1993 →	81522
	66	03/93 → 08/99	1.781	B	M	4	8	ABS, ACC, ADZ	(+)COP	82080
	66	03/93 → 08/99	1.781	B	M	4	8	ABS, ACC, ADZ	(+)COP, 01-1993 →	82080
	95	11/93 → 08/96	1.781	B	M	4	16	ADL	(-)COP	81522
	95	11/93 → 08/96	1.781	B	M	4	16	ADL	(+)COP	82080

**KW**

**cm<sup>3</sup>**

**NO. OF VALVES**

**MAGNETI MARELLI**
**SEAT**
**Ibiza II**

1.9 D	47	04/93 → 08/96	1.896	D	M	4	8	1Y, AEY	(-)COP	81522
	47	04/93 → 08/96	1.896	D	M	4	8	1Y, AEY	(+)COP	82080
	50	10/94 → 08/96	1.896	D	M	4	8	1Y	(-)COP	81522
	50	10/94 → 08/96	1.896	D	M	4	8	1Y	(+)COP	82080
1.9 SDI	47	08/96 → 08/99	1.896	D	M	4	8	AEY	(-)COP	81522
	47	08/96 → 08/99	1.896	D	M	4	8	AEY	(+)COP	82080
1.9 TD	55	03/93 → 08/96	1.896	D	M	4	8	AAZ	(-)COP, 06-1994 →	81522
	55	03/93 → 08/96	1.896	D	M	4	8	AAZ	(+)COP	82080
1.9 TDI	66	08/96 → 08/99	1.896	D	M	4	8	1Z, AHU		81528
	81	02/97 → 08/99	1.896	D	M	4	8	AFN		81528
2.0 i	85	03/93 → 08/99	1.984	B	M	4	8	2E, AGG	(-)COP	81522
	85	03/93 → 08/99	1.984	B	M	4	8	2E, AGG	(+)COP	82080
2.0 i 16V	110	08/96 → 08/99	1.984	B	M	4	16	ABF	(-)COP	81522
	110	08/96 → 08/99	1.984	B	M	4	16	ABF	(+)COP	82080

**Ibiza III**

1.0	37	08/99 → 02/02	999	B	M	4	8	ALD, ANV, AUC		81775
1.0 16V	51	10/99 → 02/02	999	B	M	4	16	AST, AVZ		81776
1.4	44	08/99 → 02/02	1.390	B	M	4	8	AKK, ANW, AUD		81775
1.4 16V	55	05/00 → 02/02	1.390	B	M	4	16	APE, AUA		81777
	74	08/99 → 02/02	1.390	B	M	4	16	AQQ, AUB		81777
1.6	74	08/99 → 02/02	1.595	B	M	4	8	AEH, AKL, APF, AUR		81702
	55	08/99 → 02/02	1.598	B	M	4	8	ALM		81527
1.8 T 20V Cupra	115	07/00 → 02/02	1.781	B	M	4	20	AQX, AYP		81703
1.9 SDI	50	08/99 → 02/02	1.896	D	M	4	8	AGP, AQM		81706
1.9 TDI	66	08/99 → 02/02	1.896	D	M	4	8	AGR, ALH		81706
	81	08/99 → 02/02	1.896	D	M	4	8	ASK, ASV		81706

**Ibiza IV**

1.2	44	06/07 → 05/08	1.198	B	M	3	6	BBM		81867	
	47	02/02 → 06/06	1.198	B	M	3	12	AZQ, BME		81867	
1.2 12V	51	05/06 → 11/09	1.198	B	M	3	12	BXV		81867	
1.4 16V	55	02/02 → 12/07	1.390	B	AM	4	16	BBY, BKY		81777	
	63	05/06 → 11/09	1.390	B	M	4	16	BXW		81777	
	74	02/02 → 11/09	1.390	B	M	4	16	AUB, BBZ		81777	
1.4 TDI	51	05/05 → 11/09	1.422	D	M	3	6	BNM		84010	<b>NEW</b>
	51	05/05 → 11/09	1.422	D	M	3	6	BNM		81791	
	55	05/02 → 12/05	1.422	D	M	3	6	AMF		84010	<b>NEW</b>
	55	05/02 → 12/05	1.422	D	M	3	6	AMF		81791	
	59	06/05 → 11/09	1.422	D	M	3	6	BMS, BNV		84010	<b>NEW</b>
	59	06/05 → 11/09	1.422	D	M	3	6	BMS, BNV		81791	
1.6	74	02/03 → 11/09	1.598	B	M	4	8	BAH		81527	
1.6 16V	77	11/06 → 11/09	1.598	B	M	4	16	BTS		81865	
1.8 T Cupra R	132	01/04 → 02/08	1.781	B	M	4	20	BBU, BLZ		81703	
1.8 T FR	110	12/03 → 05/08	1.781	B	M	4	20	BJX, BKV		81703	
1.9 SDI	47	02/02 → 12/05	1.896	D	M	4	8	ASY	→ T: 6L3000000	84052	<b>NEW</b>



**KW**

**cm<sup>3</sup>**

**NO. OF  
VALVES**

**MAGNETI  
MARELLI**
**SEAT**
**Ibiza IV**

1.9 TDI	74	02/02 → 11/09	1.896	D	M	4	8	ATD, AXR, BMT		84010	<b>NEW</b>
	74	02/02 → 11/09	1.896	D	M	4	8	ATD, AXR, BMT		81791	
	96	02/02 → 11/09	1.896	D	M	4	8	ASZ, BLT		84010	<b>NEW</b>
	96	02/02 → 11/09	1.896	D	M	4	8	ASZ, BLT		81791	
1.9 TDI Cupra R	118	03/04 → 02/08	1.896	D	M	4	8	BPX, BUK		81816	
	118	03/04 → 02/08	1.896	D	M	4	8	BPX, BUK		84011	<b>NEW</b>
2.0	85	04/02 → 11/09	1.984	B	M	4	8	AZL, BBX		81703	

**Ibiza V**

1.2	44	07/09 →	1.198	B	M	3	12	CGPB		81867	
	51	03/08 →	1.198	B	M	3	12	BZG, CGPA, CJLB		81867	
1.2 TDI	55	05/10 →	1.199	D	M	3	12	CFWA		84001	
1.2 TSI	63	08/12 →	1.197	B	M	4	8	CBZA		84045	<b>NEW</b>
	66	05/15 →	1.197	B	M	4	16	CJZC		84062	<b>NEW</b>
	77	09/10 →	1.197	B	M	4	8	CBZB		84045	<b>NEW</b>
	81	09/15 →	1.197	B	M	4	16	CJZD		84062	<b>NEW</b>
1.4	63	03/08 →	1.390	B	M	4	16	BXW, CGGB		81777	
	63	03/10 →	1.390	B	M	4	16	CGGB		81777	
1.4 TDI	59	07/08 → 06/10	1.422	D	M	3	6	BMS		84010	<b>NEW</b>
	59	07/08 → 06/10	1.422	D	M	3	6	BMS		81791	
1.4 TSI	103	10/13 →	1.395	B	M	4	16	CPTA		84062	<b>NEW</b>
	110	11/15 →	1.395	B	M	4	16	CZEA		84062	<b>NEW</b>
1.6	77	05/08 →	1.598	B	M	4	16	BTS	→ T: 6J9002800	81865	
	77	05/08 →	1.598	B	M	4	16	BTS	T →: 6J9002801	81777	
	77	02/12 →	1.598	B	M	4	16	BTS		81865	
	77	02/12 →	1.598	B	M	4	16	BTS		81777	
1.6 LPG	60	05/11 →	1.598		M	4	16	CNKA		81777	
1.6 TDI	66	05/09 →	1.598	D	M	4	16	CAYB		84001	
	77	05/09 →	1.598	D	M	4	16	CAYC, CLNA		84001	
1.9 TDI	66	07/08 → 06/10	1.896	D	M	4	8	BXJ		84010	<b>NEW</b>
	66	07/08 → 06/10	1.896	D	M	4	8	BXJ		81791	
	77	03/08 → 06/10	1.896	D	M	4	8	BLS		84010	<b>NEW</b>
	77	03/08 → 06/10	1.896	D	M	4	8	BLS		81791	
2.0	85	10/08 →	1.984	B	M	4	8	CEKA		81703	
2.0 TDI	105	01/10 →	1.968	D	M	4	16	CFHD		84001	

**Inca**

1.4 16V	55	04/00 → 06/03	1.390	B	M	4	16	AUA		81777	
1.4 i	44	11/95 → 06/03	1.390	B	M	4	8	AEX, AKV, APQ, AUD	01-1998 →	81527	
1.6 i	55	11/95 → 05/98	1.595	B	M	4	8	1F	(-)COP, 11-1995 →	81522	
	55	11/95 → 05/98	1.595	B	M	4	8	1F	(+)COP	82080	
	55	11/95 → 05/98	1.595	B	M	4	8	1F	(+)COP, 11-1995 →	82080	
	55	06/97 → 09/00	1.598	B	M	4	8	AEE, ALM		81527	
1.7 D	42	09/96 → 06/03	1.716	D	M	4	8	AHB	(-)COP	81522	
	42	09/96 → 06/03	1.716	D	M	4	8	AHB	(+)COP	82080	

**KW**

**cm<sup>3</sup>**

**NO. OF VALVES**

**MAGNETI MARELLI**
**SEAT**
**Inca**

1.9 D	47	11/95 → 06/03	1.896	D	M	4	8	1Y	(-)COP, 11-1995 →	81522
	47	11/95 → 06/03	1.896	D	M	4	8	1Y	(+)COP	82080
	47	11/95 → 06/03	1.896	D	M	4	8	1Y	(+)COP, 11-1995 →	82080
1.9 SDI	47	11/95 → 06/03	1.896	D	M	4	8	1Y, AEY, AYQ	(-)COP, 11-1995 →	81522
	47	11/95 → 06/03	1.896	D	M	4	8	1Y, AEY, AYQ	(+)COP	82080
	47	11/95 → 06/03	1.896	D	M	4	8	1Y, AEY, AYQ	(+)COP, 11-1995 →	82080
1.9 TDI	66	09/96 → 06/03	1.896	D	M	4	8	ALH	11-1995 →	81706

**Leon I**

1.4 16V	55	11/99 → 06/06	1.390	B	M	4	16	AHW, APE, AUA, AXP, BCA		81777
1.6	74	11/99 → 06/06	1.595	B	M	4	8	AEH, AKL, APF		81702
	75	10/05 → 06/06	1.595	B	M	4	8	BFQ, BGU		81702
1.6 16 V	77	09/00 → 06/06	1.598	B	M	4	16	ATN, AUS, AZD, BCB		81840
1.8 20V	92	11/99 → 06/06	1.781	B	AM	4	20	AGN, APG		81703
1.8 20V T	132	11/99 → 06/06	1.781	B	M	4	20	APP, AUQ		81703
1.8 20V T 4	132	11/99 → 06/06	1.781	B	M	4	20	AJQ, ARY		81703
1.8 T Cupra R	154	02/02 → 06/06	1.781	B	M	4	20	AMK		81703
	165	07/03 → 06/06	1.781	B	M	4	20	BAM		81703
1.9 SDI	50	11/99 → 06/06	1.896	D	M	4	8	AQM		81706
1.9 TDI	66	11/99 → 06/06	1.896	D	M	4	8	AGR, ALH		81706
	74	10/05 → 06/06	1.896	D	M	4	8	AXR		81816
	74	10/05 → 06/06	1.896	D	M	4	8	AXR		84011 <b>NEW</b>
	81	11/99 → 06/06	1.896	D	M	4	8	AHF, ASV		81706
	96	05/03 → 06/06	1.896	D	M	4	8	ASZ		81816
	96	05/03 → 06/06	1.896	D	M	4	8	ASZ		84011 <b>NEW</b>
	110	09/00 → 06/06	1.896	D	M	4	8	ARL		81816
	110	09/00 → 06/06	1.896	D	M	4	8	ARL		84011 <b>NEW</b>
1.9 TDI Syncro	110	05/02 → 06/06	1.896	D	M	4	8	ARL		81816
	110	05/02 → 06/06	1.896	D	M	4	8	ARL		84011 <b>NEW</b>
2.8	150	05/02 → 06/04	2.792	B	M	6	24	BDE		81866
2.8 Cupra 4	150	02/01 → 06/06	2.792	B	M	6	24	AUE	→ 09-2001	81773
	150	02/01 → 06/06	2.792	B	M	6	24	AUE	10-2001 →	81866

**Leon II**

1.2 TSI	77	02/10 → 12/12	1.197	B	M	4	8	CBZB		84045 <b>NEW</b>
1.4 16V	63	06/06 → 12/12	1.390	B	M	4	16	BXW, CGGB		81777
1.4 TSI	92	11/07 → 12/12	1.390	B	M	4	16	CAXC		82097
1.6	75	07/05 → 12/12	1.595	B	M	4	8	BSE, BSF, CCSA, CMXA		81702
1.6 LPG	75	12/09 → 12/12	1.595		M	4	8	CHGA		81702
1.6 MultiFuel	75	11/10 → 12/12	1.595		M	4	8	BSE, CMXA		81702
1.6 TDI	66	11/10 → 12/12	1.598	D	M	4	16	CAYB		84001
	77	02/10 → 12/12	1.598	D	M	4	16	CAYC		84001
1.8 TSI	118	06/07 → 12/12	1.798	B	M	4	16	BZB, CDAA		84016 <b>NEW</b>

		<b>KW</b>		<b>cm<sup>3</sup></b>				<b>NO. OF VALVES</b>		
--	--	-----------	--	-----------------------	--	--	--	----------------------	--	--

## SEAT

### Leon II

1.9 TDI	66	06/07 → 12/10	1.896	D	M	4	8	BXF		84010	<b>NEW</b>
	66	06/07 → 12/10	1.896	D	M	4	8	BXF		81791	
	77	07/05 → 12/10	1.896	D	M	4	8	BKC, BLS, BXE		84010	<b>NEW</b>
	77	07/05 → 12/10	1.896	D	M	4	8	BKC, BLS, BXE		81791	
	81	10/05 → 12/12	1.896	D	M	4	8	ASV		84010	<b>NEW</b>
	81	10/05 → 12/12	1.896	D	M	4	8	ASV		81791	
2.0 Cupra R	195	09/09 → 12/12	1.984	B	M	4	16	CDLA		84016	<b>NEW</b>
2.0 FSI	110	07/05 → 05/10	1.984	B	M	4	16	BLR, BLY, BVY, BVZ		81702	
2.0 TDI	100	07/05 → 05/10	1.968	D	M	4	16	AZV		81816	
	100	07/05 → 05/10	1.968	D	M	4	16	AZV		84011	<b>NEW</b>
	103	10/05 → 10/10	1.968	D	M	4	8	BMM		81816	
	103	10/05 → 10/10	1.968	D	M	4	8	BMM		84011	<b>NEW</b>
	125	05/06 → 12/12	1.968	D	M	4	16	BMN, CEGA, CFJA		81816	
	125	05/06 → 12/12	1.968	D	M	4	16	BMN, CEGA, CFJA		84011	<b>NEW</b>
2.0 TDI 16V	103	07/05 → 12/12	1.968	D	M	4	16	BKD, CFHC, CLCB		81816	
	103	07/05 → 12/12	1.968	D	M	4	16	BKD, CFHC, CLCB		84011	<b>NEW</b>
2.0 TFSI	136	09/05 → 05/06	1.984	B	M	4	16	BWA1		82025	
	147	05/05 → 03/09	1.984	B	M	4	16	BWA		82025	
	155	06/09 → 12/12	1.984	B	M	4	16	CCZB		84016	<b>NEW</b>
	177	11/06 → 05/11	1.984	B	M	4	16	BWJ, CDLD		82025	

### Leon III

1.0 TSI	85	05/15 →	999	B	M	3	12	CHZD		84062	<b>NEW</b>
1.2 TSI	63	12/12 →	1.197	B	M	4	16	CJZB, CYVA		84062	<b>NEW</b>
	77	01/13 →	1.197	B	M	4	16	CJZA		84062	<b>NEW</b>
	81	04/14 →	1.197	B	M	4	16	CYVB		84062	<b>NEW</b>
1.4 TGI	81	02/13 →	1.395		M	4	16	CPWA		84062	<b>NEW</b>
1.4 TSI	90	11/12 →	1.395	B	M	4	16	CMBA, CXSA		84062	<b>NEW</b>
	92	05/14 →	1.395	B	M	4	16	CZCA		84062	<b>NEW</b>
	103	09/12 →	1.395	B	M	4	16	CHPA, CPTA		84062	<b>NEW</b>
	110	05/14 →	1.395	B	M	4	16	CZEA		84062	<b>NEW</b>
	132	02/13 →	1.798	B	M	4	16	CJSA, CJSB		84037	<b>NEW</b>
1.8 TSI 4Drive	132	11/14 →	1.798	B	M	4	16	CJSA		84037	<b>NEW</b>
2.0 Cupra	195	10/13 →	1.984	B	M	4	16	CJXE		84037	<b>NEW</b>
	206	10/13 →	1.984	B	M	4	16	CJXA		84037	<b>NEW</b>

### Malaga

1.2	44	05/85 → 12/93	1.193	B	M	4	8	021A1000		81498	
	47	11/84 → 12/93	1.193	B	M	4	8	021A1000		81498	
1.2 i	52	12/89 → 12/93	1.193	B	M	4	8	021C.1000		81498	
1.5	63	05/85 → 12/93	1.461	B	M	4	8	021A2000		81498	
1.5 i	74	01/87 → 12/93	1.461	B	M	4	8	021B.2000		81498	
1.5 i Cat.	66	10/86 → 12/93	1.461	B	M	4	8	021A2000, 021C.2000, 021D.2000		81498	

**KW**

**cm<sup>3</sup>**

**NO. OF VALVES**

**SEAT**
**Marbella**

0.8	25	08/86 → 12/93	843	B	M	4	8	08NCA		81415
0.9	32	07/97 → 10/98	899	B	M	4	8	08NCB		81415
	29	01/87 → 12/93	903	B	M	4	8	09NCA		81415
	29	01/87 → 12/93	903	B	M	4	8	09NCA, 100GL7000		81415
	30	11/96 → 10/98	899	B	M	4	8	08NCB		81415
0.9 Cat.	29	01/87 → 12/93	903	B	M	4	8	09NCB		81415
	29	01/90 → 11/96	903	B	M	4	8	09NCB, 100GL7000		81415

**Terra**

0.9	29	02/87 → 12/96	903	B	M	4	8	09NCA		81415
0.9 Cat.	29	02/92 → 12/94	903	B	M	4	8	09NCB		81415
1.3 D	33	03/90 → 12/94	1.272	D	M	4	8	MN		81525
1.4 D	35	10/90 → 12/95	1.398	D	M	4	8	1W		81525

**Toledo I**

1.6 i	52	05/91 → 12/93	1.595	B	M	4	8	1F	(-)COP	81522
	52	05/91 → 12/93	1.595	B	M	4	8	1F	(+)COP	82080
	54	05/91 → 03/99	1.595	B	M	4	8	1F, ABN, EZ	(-)COP, 05-1991 →	81522
	54	05/91 → 03/99	1.595	B	M	4	8	1F, ABN, EZ	(+)COP	82080
	54	05/91 → 03/99	1.595	B	M	4	8	1F, ABN, EZ	(+)COP, 05-1991 →	82080
	55	01/93 → 03/99	1.595	B	M	4	8	1F	(-)COP, 05-1991 →	81522
	55	01/93 → 03/99	1.595	B	M	4	8	1F	(+)COP	82080
	55	01/93 → 03/99	1.595	B	M	4	8	1F	(+)COP, 05-1991 →	82080
	74	11/96 → 03/99	1.595	B	M	4	8	AFT	(-)COP	81522
	74	11/96 → 03/99	1.595	B	M	4	8	AFT	(+)COP	82080
1.8 16V	92	05/91 → 03/99	1.781	B	M	4	16	PL	(-)COP, 05-1991 →	81522
	92	05/91 → 03/99	1.781	B	M	4	16	PL	(+)COP	82080
	92	05/91 → 03/99	1.781	B	M	4	16	PL	(+)COP, 05-1991 →	82080
	98	05/91 → 03/99	1.781	B	M	4	16	KR	(-)COP, 05-1991 →	81522
	98	05/91 → 03/99	1.781	B	M	4	16	KR	(+)COP	82080
	98	05/91 → 03/99	1.781	B	M	4	16	KR	(+)COP, 05-1991 →	82080
1.8 GT	102	05/91 → 11/92	1.781	B	M	4	16	KR	(-)COP	81522
	102	05/91 → 11/92	1.781	B	M	4	16	KR	(+)COP	82080
1.8 i	65	05/91 → 12/96	1.781	B	M	4	8	RP	(-)COP	81522
	65	05/91 → 12/96	1.781	B	M	4	8	RP	(+)COP	82080
	66	11/93 → 12/96	1.781	B	M	4	8	ABS, ACC, ADZ	(-)COP	81522
	66	11/93 → 12/96	1.781	B	M	4	8	ABS, ACC, ADZ	(+)COP	82080
1.9 D	47	12/95 → 03/99	1.896	D	M	4	8	1Y	(-)COP, 05-1991 →	81522
	47	12/95 → 03/99	1.896	D	M	4	8	1Y	(+)COP	82080
	47	12/95 → 03/99	1.896	D	M	4	8	1Y	(+)COP, 05-1991 →	82080
	50	05/91 → 03/99	1.896	D	M	4	8	1Y	(-)COP, 05-1991 →	81522
	50	05/91 → 03/99	1.896	D	M	4	8	1Y	(+)COP	82080
	50	05/91 → 03/99	1.896	D	M	4	8	1Y	(+)COP, 05-1991 →	82080
1.9 TD	55	05/91 → 03/99	1.896	D	M	4	8	AAZ	(-)COP, 05-1991 →	81522
	55	05/91 → 03/99	1.896	D	M	4	8	AAZ	(+)COP	82080
	55	05/91 → 03/99	1.896	D	M	4	8	AAZ	(+)COP, 05-1991 →	82080

**KW**

**cm<sup>3</sup>**

**NO. OF VALVES**

**SEAT**
**Toledo I**

1.9 TDI	66	08/95 → 03/99	1.896	D	M	4	8	1Z, AHU	(-)COP, 05-1991 →	81522
	66	08/95 → 03/99	1.896	D	M	4	8	1Z, AHU	(+)COP	82080
	66	08/95 → 03/99	1.896	D	M	4	8	1Z, AHU	(+)COP, 05-1991 →	82080
	81	11/96 → 03/99	1.896	D	M	4	8	AFN	(-)COP, 05-1991 →	81522
	81	11/96 → 03/99	1.896	D	M	4	8	AFN	(+)COP	82080
	81	11/96 → 03/99	1.896	D	M	4	8	AFN	(+)COP, 05-1991 →	82080
2.0 i	85	05/91 → 03/99	1.984	B	M	4	8	2E, AGG	(-)COP	81522
	85	05/91 → 03/99	1.984	B	M	4	8	2E, AGG	(+)COP	82080
2.0 i 16V/2.0 i 16V	110	11/93 → 03/99	1.984	B	M	4	16	ABF	(-)COP, 01-1997 →	81522
	110	11/93 → 03/99	1.984	B	M	4	16	ABF	(+)COP	82080
	110	11/93 → 03/99	1.984	B	M	4	16	ABF	(+)COP, 01-1997 →	82080

**Toledo II**

1.4 16V	55	01/00 → 05/02	1.390	B	M	4	16	AHW, APE, AUA, AXP, BCA		81777
1.6	74	10/98 → 07/04	1.595	B	M	4	8	AEH, AKL, APF	08-1995 →	81702
1.6 16V	77	06/00 → 05/06	1.598	B	M	4	16	AUS, AZD, BCB		81840
1.8 20V	92	10/98 → 07/04	1.781	B	AM	4	20	AGN, APG		81703
1.8 20VT	132	09/00 → 07/04	1.781	B	AM	4	20	APP, AUQ		81703
1.9 SDI	50	11/99 → 06/04	1.896	D	M	4	8	AQM		81706
1.9 TDI	66	03/99 → 07/04	1.896	D	M	4	8	AGR, ALH	05-1991 →	81706
	81	10/98 → 07/04	1.896	D	M	4	8	AHF, ASV	05-1991 →	81706
	96	05/03 → 05/06	1.896	D	M	4	8	ASZ		81816
	96	05/03 → 05/06	1.896	D	M	4	8	ASZ		84011 <b>NEW</b>
	110	10/00 → 07/04	1.896	D	M	4	8	ARL		81816
	110	10/00 → 07/04	1.896	D	M	4	8	ARL		84011 <b>NEW</b>
2.3 V5	110	10/98 → 11/00	2.324	B	M	5	10	AGZ		81856
2.3 V5 20V	125	09/00 → 11/03	2.324	B	M	5	20	AQN		81856

**Toledo III**

1.6	75	10/04 → 05/09	1.595	B	M	4	8	BGU, BSE, BSF, CCSA		81702
1.8 TFSI	118	01/07 → 05/09	1.798	B	M	4	16	BYT, BZB, CDAA		84016 <b>NEW</b>
1.9 TDI	77	10/04 → 05/09	1.896	D	M	4	8	BJB, BKC, BLS, BXE		84010 <b>NEW</b>
	77	10/04 → 05/09	1.896	D	M	4	8	BJB, BKC, BLS, BXE		81791
2.0 FSI	110	10/04 → 05/09	1.984	B	M	4	16	BLR, BLY, BVY, BVZ		81702
2.0 TDI	100	09/04 → 05/09	1.968	D	M	4	16	AZV		81816
	100	09/04 → 05/09	1.968	D	M	4	16	AZV		84011 <b>NEW</b>
	103	11/05 → 05/09	1.968	D	M	4	8	BMM		81816
	103	11/05 → 05/09	1.968	D	M	4	8	BMM		84011 <b>NEW</b>
	125	01/06 → 05/09	1.968	D	M	4	16	BMN, CEGA		81816
	125	01/06 → 05/09	1.968	D	M	4	16	BMN, CEGA		84011 <b>NEW</b>
2.0 TDI 16V	103	04/04 → 05/09	1.968	D	M	4	16	BKD		81816
	103	04/04 → 05/09	1.968	D	M	4	16	BKD		84011 <b>NEW</b>
2.0 TFSI	147	11/05 → 05/09	1.984	B	M	4	16	BWA		82025

**KW**

**cm<sup>3</sup>**

**NO. OF VALVES**

**MAGNETI MARELLI**

## SEAT

### Toledo IV

1.2	55	07/12 →	1.198	B	M	3	12	CGPC		81867
1.2 TSI	63	07/12 →	1.197	B	M	4	8	CBZA		84045 <b>NEW</b>
	77	07/12 →	1.197	B	M	4	8	CBZB		84045 <b>NEW</b>
1.4 TSI	90	07/12 →	1.390	B	M	4	16	CAXA		82097
1.6 TDI	77	07/12 →	1.598	D	M	4	16	CAYC, CLNA		84001

## SKODA

### Fabia I, Station Wagon, Van

1.2	40	08/02 → 03/08	1.198	B	M	3	6	AWY, BMD		81867
	47	01/03 → 03/08	1.198	B	M	3	12	AZQ, BME		81867
1.4 16V	55	12/99 → 03/08	1.390	B	AM	4	16	AUA, BBY, BKY		81777
	59	04/06 → 12/07	1.390	B	M	4	16	BUD		81777
	74	12/99 → 03/08	1.390	B	M	4	16	AUB, BBZ		81777
	74	04/00 → 12/07	1.390	B	AM	4	16	AUB, BBZ		81777
1.4 TDI	51	10/05 → 03/08	1.422	D	M	3	6	BNM		84010 <b>NEW</b>
	51	10/05 → 03/08	1.422	D	M	3	6	BNM		81791
	55	04/03 → 03/08	1.422	D	M	3	6	AMF		84010 <b>NEW</b>
	55	04/03 → 03/08	1.422	D	M	3	6	AMF		81791
	59	10/05 → 03/08	1.422	D	M	3	6	BNV		84010 <b>NEW</b>
	59	10/05 → 03/08	1.422	D	M	3	6	BNV		81791
1.9 SDI	47	12/99 → 03/08	1.896	D	M	4	8	ASY	→ T: 6Y3X628012	84052 <b>NEW</b>
	47	12/99 → 03/08	1.896	D	M	4	8	ASY	T →: 6Y3X628013	82013
	74	01/00 → 03/08	1.896	D	M	4	8	ATD, AXR		84010 <b>NEW</b>
	74	01/00 → 03/08	1.896	D	M	4	8	ATD, AXR		81791
1.9 TDI RS	96	06/03 → 03/08	1.896	D	M	4	8	ASZ, BLT		84010 <b>NEW</b>
	96	06/03 → 03/08	1.896	D	M	4	8	ASZ, BLT		81791
2.0	85	12/99 → 03/08	1.984	B	M	4	8	AZL		81703

### Fabia II, Station Wagon, Van

1.2	44	12/06 → 12/14	1.198	B	M	3	6	BBM, CHFA		81867
	51	01/07 → 12/14	1.198	B	M	3	12	BZG, CEVA, CGPA, CHTA		81867
1.2 12V	44	11/11 → 12/14	1.198	B	M	3	12	CGPB		81867
1.2 TDI	55	05/10 → 12/14	1.199	D	M	3	12	CFWA		84001
1.2 TSI	63	03/10 → 12/14	1.197	B	M	4	8	CBZA		84045 <b>NEW</b>
	77	03/10 → 12/14	1.197	B	M	4	8	CBZB		84045 <b>NEW</b>
1.4	63	01/07 → 12/14	1.390	B	M	4	16	BXW, CGGB		81777
1.4 TDI	51	02/07 → 03/10	1.422	D	M	3	6	BNM		84010 <b>NEW</b>
	51	02/07 → 03/10	1.422	D	M	3	6	BNM		81791
	59	01/07 → 03/10	1.422	D	M	3	6	BMS, BNV		84010 <b>NEW</b>
	59	01/07 → 03/10	1.422	D	M	3	6	BMS, BNV		81791
1.6	77	04/07 → 12/14	1.598	B	M	4	16	BTS, CFNA		81865
1.6 TDI	55	04/10 → 12/14	1.598	D	M	4	16	CAYA		84001
	66	03/10 → 12/14	1.598	D	M	4	16	CAYB		84001
	77	03/10 → 12/14	1.598	D	M	4	16	CAYC		84001

**KW**

**cm<sup>3</sup>**

**NO. OF VALVES**

**SKODA**
**Fabia II, Station Wagon, Van**

1.9 TDI	77	04/07 → 03/10	1.896	D	M	4	8	BLS, BSW		84010	<b>NEW</b>
	77	04/07 → 03/10	1.896	D	M	4	8	BLS, BSW		81791	

**Fabia III, Station Wagon**

1.2 TSI	66	08/14 →	1.197	B	M	4	16	CJZC		84062	<b>NEW</b>
	81	08/14 →	1.197	B	M	4	16	CJZD		84062	<b>NEW</b>

**Felicia I, Station Wagon**

1.6	55	06/97 → 04/02	1.598	B	M	4	8	AEE		81527	
1.6 GLX	55	08/95 → 03/98	1.598	B	M	4	8	AEE		81527	
1.6 LX	55	08/95 → 03/98	1.598	B	M	4	8	AEE, EA111		81527	
1.9 D	47	10/95 → 03/98	1.896	D	M	4	8	AEF		81528	

**Felicia II, Station Wagon**

1.6	55	01/98 → 06/01	1.598	B	M	4	8	AEE		81527	
1.9 D	47	01/98 → 06/01	1.896	D	M	4	8	AEF		81528	

**Octavia I, Station Wagon**

1.4 16V	55	09/00 → 12/10	1.390	B	M	4	16	AXP, BCA		81777	
1.6	74	02/97 → 12/07	1.595	B	AM	4	8	AEH, AKL		81702	
	74	07/98 → 12/07	1.595	B	M	4	8	AEH, AKL		81702	
	75	11/00 → 12/10	1.595	B	M	4	8	AVU, BFQ		81702	
	55	09/96 → 09/04	1.598	B	M	4	8	AEE		81527	
1.8	92	09/96 → 07/00	1.781	B	M	4	20	AGN		81703	
1.8 20V	92	07/98 → 07/00	1.781	B	M	4	20	AGN		81703	
1.8 T	110	08/97 → 12/10	1.781	B	AM	4	20	AGU, ARX, ARZ, AUM		81703	
	110	07/98 → 12/10	1.781	B	M	4	20	AGU, ARX, ARZ, AUM		81703	
1.8 T 4x4	110	05/01 → 05/06	1.781	B	M	4	20	AGU, ARX, AUM		81703	
	110	05/01 → 05/06	1.781	B	M	4	20	ARX, AUM		81703	
1.9 SDI	50	06/97 → 12/03	1.896	D	M	4	8	AGP, AQM		81706	
1.9 TDI	66	09/96 → 03/10	1.896	D	AM	4	8	AGR, ALH		81706	
	66	07/98 → 03/10	1.896	D	M	4	8	AGR, ALH		81706	
	74	10/05 → 12/10	1.896	D	M	4	8	AXR		81816	
	74	10/05 → 12/10	1.896	D	M	4	8	AXR		84011	<b>NEW</b>
	81	08/97 → 01/06	1.896	D	M	4	8	AHF, ASV		81706	
	96	09/02 → 09/04	1.896	D	M	4	8	ASZ		81816	
	96	09/02 → 09/04	1.896	D	M	4	8	ASZ		84011	<b>NEW</b>
1.9 TDI 4x4	66	11/99 → 02/06	1.896	D	M	4	8	AGR		81706	
	74	09/00 → 01/06	1.896	D	M	4	8	ATD		81816	
	74	09/00 → 01/06	1.896	D	M	4	8	ATD		84011	<b>NEW</b>
2.0	85	04/99 → 05/07	1.984	B	AM	4	8	AEG, APK, AQY, AZH, AZJ		81703	
	85	04/99 → 05/07	1.984	B	M	4	8	AEG, APK, AQY, AZH, AZJ		81703	
2.0 4x4	85	08/00 → 09/04	1.984	B	M	4	8	AZH, AZJ		81703	
	88	01/00 → 12/10	1.984	B	M	4	8	ATF		81703	
RS 1.8 T	132	05/01 → 01/06	1.781	B	M	4	20	AUQ		81703	

**KW**

**cm<sup>3</sup>**

**NO. OF VALVES**

**SKODA**
**Octavia II, Station Wagon**

1.2 TSI	77	02/10 → 06/13	1.197	B	M	4	8	CBZB		84045	<b>NEW</b>
1.4	55	05/04 → 05/06	1.390	B	M	4	16	BCA		81777	
	59	06/04 → 04/13	1.390	B	M	4	16	BUD, CGGA		81777	
1.4 TSI	90	11/08 → 06/13	1.390	B	M	4	16	CAXA		82097	
1.6	75	06/04 → 06/13	1.595	B	M	4	8	BGU, BSE, BSF, CCSA, CMXA		81702	
1.6 FSI	85	02/04 → 10/08	1.598	B	M	4	16	BLF		81865	
1.6 LPG	75	08/09 → 11/12	1.595		M	4	8	CHGA		81702	
1.6 MultiFuel	75	01/08 → 06/13	1.595		M	4	8	CCSA, CMXA		81702	
1.6 TDI	77	06/09 → 04/13	1.598	D	M	4	16	CAYC		84001	
1.6 TDI 4x4	77	06/09 → 02/13	1.598	D	M	4	16	CAYC		84001	
1.8 TSI	112	03/09 → 06/13	1.798	B	M	4	16	CDAB		84016	<b>NEW</b>
	118	06/07 → 04/13	1.798	B	M	4	16	BZB, CDAА		84016	<b>NEW</b>
1.8 TSI 4x4	112	03/09 → 02/13	1.798	B	M	4	16	CDAB		84016	<b>NEW</b>
	118	11/08 → 02/13	1.798	B	M	4	16	CDAА		84016	<b>NEW</b>
1.9 TDI	77	06/04 → 12/10	1.896	D	M	4	8	BJB, BKC, BLS, BXE		84010	<b>NEW</b>
	77	06/04 → 12/10	1.896	D	M	4	8	BJB, BKC, BLS, BXE		81791	
1.9 TDI 4x4	77	11/04 → 12/10	1.896	D	M	4	8	BKC, BLS, BXE		84010	<b>NEW</b>
	77	11/04 → 12/10	1.896	D	M	4	8	BKC, BLS, BXE		81791	
2.0 FSI	110	11/04 → 10/08	1.984	B	M	4	16	BLR, BLY, BVY, BVZ		81702	
2.0 FSI 4x4	110	11/04 → 10/08	1.984	B	M	4	16	BLX, BVX		81702	
2.0 RS	147	10/05 → 02/13	1.984	B	M	4	16	BWA, CCZA		82025	
2.0 TDI	81	03/10 → 06/13	1.968	D	M	4	16	CFHF, CLCA		84001	
	100	02/04 → 05/10	1.968	D	M	4	16	AZV		81816	
	100	02/04 → 05/10	1.968	D	M	4	16	AZV		84011	<b>NEW</b>
	103	11/05 → 05/10	1.968	D	M	4	8	BMM		81816	
	103	11/05 → 05/10	1.968	D	M	4	8	BMM		84011	<b>NEW</b>
2.0 TDI 16V	100	02/04 → 05/10	1.968	D	M	4	16	AZV		81816	
	100	02/04 → 05/10	1.968	D	M	4	16	AZV		84011	<b>NEW</b>
	103	02/04 → 04/13	1.968	D	M	4	16	BKD, CFHC, CLCB		81816	
	103	02/04 → 04/13	1.968	D	M	4	16	BKD, CFHC, CLCB		84011	<b>NEW</b>
2.0 TDI 16V 4x4	103	05/10 → 02/13	1.968	D	M	4	16	CFHC		84001	
2.0 TDI 4x4	81	05/11 → 02/13	1.968	D	M	4	16	CFHF		84001	
	103	07/06 → 05/10	1.968	D	M	4	8	BMM		81816	
	103	07/06 → 05/10	1.968	D	M	4	8	BMM		84011	<b>NEW</b>
2.0 TDI RS	125	04/06 → 02/13	1.968	D	M	4	16	BMN, CEGA		81816	
	125	04/06 → 02/13	1.968	D	M	4	16	BMN, CEGA		84011	<b>NEW</b>

**Octavia III, Station Wagon**

1.2 TSI	63	11/12 →	1.197	B	M	4	16	CJZB		84062	<b>NEW</b>
	77	11/12 →	1.197	B	M	4	16	CJZA		84062	<b>NEW</b>
	81	05/15 →	1.197	B	M	4	16	CYVB		84062	<b>NEW</b>
	103	11/12 →	1.395	B	M	4	16	CHPA		84062	<b>NEW</b>
	110	08/14 →	1.395	B	M	4	16	CHPB, CZDA		84062	<b>NEW</b>
1.4 TSI G-TEC	81	11/13 →	1.395		M	4	16	CPWA		84062	<b>NEW</b>



**KW**

**cm<sup>3</sup>**

**NO. OF VALVES**

**SKODA**
**Octavia III, Station Wagon**

1.6	81	01/14 →	1.598	B	M	4	16	CWVA		84062	<b>NEW</b>
1.8 TSI	132	11/12 →	1.798	B	M	4	16	CJSA		84037	<b>NEW</b>
	132	11/12 →	1.798	B	M	4	16	CJSA, CJSB		84037	<b>NEW</b>
1.8 TSI 4x4	132	09/14 →	1.798	B	M	4	16	CJSA		84037	<b>NEW</b>
	132	11/12 →	1.798	B	M	4	16	CJSB		84037	<b>NEW</b>
2.0 TSI RS	162	05/13 →	1.984	B	M	4	16	CHHB		84037	<b>NEW</b>
	169	05/15 →	1.984	B	M	4	16	CHHA		84037	<b>NEW</b>

**Rapid II**

1.2	55	07/12 →	1.198	B	M	3	12	CGPC		81867	
1.2 TSI	63	07/12 →	1.197	B	M	4	8	CBZA		84045	<b>NEW</b>
	77	07/12 →	1.197	B	M	4	8	CBZB		84045	<b>NEW</b>
1.4 TSI	90	07/12 →	1.390	B	M	4	16	CAXA		82097	
	92	05/15 →	1.395	B	M	4	16	CZCA		84062	<b>NEW</b>
1.6	77	07/12 →	1.598	B	M	4	16	CFNA		81865	
1.6 TDI	66	08/13 →	1.598	D	M	4	16	CAYB		84001	
	77	07/12 →	1.598	D	M	4	16	CAYC, CLNA		84001	

**Roomster, Van**

1.2	47	05/06 → 01/07	1.198	B	M	3	12	BME		81867	
	51	01/07 → 05/15	1.198	B	M	3	12	BZG, CGPA		81867	
1.2 TDI	55	03/10 → 05/15	1.199	D	M	3	12	CFWA		84001	
1.2 TSI	63	03/10 → 05/15	1.197	B	M	4	8	CBZA		84045	<b>NEW</b>
	77	03/10 → 05/15	1.197	B	M	4	8	CBZB		84045	<b>NEW</b>
1.4	63	09/06 → 05/15	1.390	B	M	4	16	BXW, CGGB		81777	
1.4 TDI	51	07/06 → 03/10	1.422	D	M	3	6	BNM		84010	<b>NEW</b>
	51	07/06 → 03/10	1.422	D	M	3	6	BNM		81791	
	59	09/06 → 03/10	1.422	D	M	3	6	BMS, BNV		84010	<b>NEW</b>
	59	09/06 → 03/10	1.422	D	M	3	6	BMS, BNV		81791	
1.6	77	09/06 → 05/15	1.598	B	M	4	16	BTS, CFNA		81865	
1.6 TDI	66	03/10 → 05/15	1.598	D	M	4	16	CAYB		84001	
	77	03/10 → 05/15	1.598	D	M	4	16	CAYC		84001	
1.9 TDI	74	03/06 → 05/06	1.896	D	M	4	8	AXR		81816	
	74	03/06 → 05/06	1.896	D	M	4	8	AXR		84011	<b>NEW</b>
	77	09/06 → 03/10	1.896	D	M	4	8	BLS, BSW		84010	<b>NEW</b>
	77	09/06 → 03/10	1.896	D	M	4	8	BLS, BSW		81791	

**Superb**

1.4 TSI	92	03/15 →	1.395	B	M	4	16	CZCA		84062	<b>NEW</b>
	110	03/15 →	1.395	B	M	4	16	CZDA, CZEA		84062	<b>NEW</b>
1.4 TSI 4x4	110	03/15 →	1.395	B	M	4	16	CZDA, CZEA		84062	<b>NEW</b>
1.8 TSI	132	03/15 →	1.798	B	M	4	16	CJSA, CJSC		84037	<b>NEW</b>
2.0 TSI	162	03/15 →	1.984	B	M	4	16	CHHB		84037	<b>NEW</b>
2.0 TSI 4x4	206	03/15 →	1.984	B	M	4	16	CJXA		84037	<b>NEW</b>

**KW**

**cm<sup>3</sup>**

**NO. OF VALVES**

**MAGNETI MARELLI**
**SKODA**
**Superb I**

1.8 T	110	12/01 → 03/08	1.781	B	M	4	20	AWT		81703
1.9 TDI	74	08/02 → 10/05	1.896	D	M	4	8	AVB		81816
	74	08/02 → 10/05	1.896	D	M	4	8	AVB		84011 <b>NEW</b>
	77	10/05 → 05/07	1.896	D	M	4	8	BSV		81816
	77	10/05 → 05/07	1.896	D	M	4	8	BSV		84011 <b>NEW</b>
	85	01/07 → 03/08	1.896	D	M	4	8	BPZ		81816
	85	01/07 → 03/08	1.896	D	M	4	8	BPZ		84011 <b>NEW</b>
	96	12/01 → 03/08	1.896	D	M	4	8	AVF, AWX		81816
	96	12/01 → 03/08	1.896	D	M	4	8	AVF, AWX		84011 <b>NEW</b>
2.0	85	12/01 → 03/08	1.984	B	M	4	8	AZM		81703
2.0 TDI	103	10/05 → 03/08	1.968	D	M	4	8	BSS		81816
	103	10/05 → 03/08	1.968	D	M	4	8	BSS		84011 <b>NEW</b>
2.5 TDI	114	12/01 → 08/03	2.496	D	AM	6	24	AYM		81705
	120	06/03 → 03/08	2.496	D	M	6	24	BDG		81705
2.8 V6	140	06/02 → 03/08	2.771	B	M	6	30	BBG		81842
	142	12/01 → 03/08	2.771	B	AM	6	30	AMX		81842

**Superb II, Station Wagon**

1.4 TSI	92	07/08 → 05/15	1.390	B	M	4	16	CAXC		82097
1.6 TDI	77	09/10 → 05/15	1.598	D	M	4	16	CAYC		84001
1.8 TSI	112	03/09 → 05/15	1.798	B	M	4	16	CDAB		84016 <b>NEW</b>
	118	03/08 → 05/15	1.798	B	M	4	16	BZB, CDAA		84016 <b>NEW</b>
	118	10/09 → 05/15	1.798	B	M	4	16	CDAA		84016 <b>NEW</b>
1.8 TSI 4x4	112	03/09 → 05/15	1.798	B	M	4	16	CDAB		84016 <b>NEW</b>
	118	11/08 → 05/15	1.798	B	M	4	16	CDAA		84016 <b>NEW</b>
1.9 TDI	77	03/08 → 11/10	1.896	D	M	4	8	BLS, BXE		84010 <b>NEW</b>
	77	03/08 → 11/10	1.896	D	M	4	8	BLS, BXE		81791
2.0 TDI	103	03/08 → 05/10	1.968	D	M	4	8	BMP		81816
	103	03/08 → 05/10	1.968	D	M	4	8	BMP		84011 <b>NEW</b>
	125	07/08 → 05/15	1.968	D	M	4	16	CBBB, CFGB		81816
	125	07/08 → 05/15	1.968	D	M	4	16	CBBB, CFGB		84011 <b>NEW</b>
2.0 TDI 16V	103	01/09 → 05/15	1.968	D	M	4	16	BKD, CFFB, CLJA		81816
	103	01/09 → 05/15	1.968	D	M	4	16	BKD, CFFB, CLJA		84011 <b>NEW</b>
2.0 TDI 16V 4x4	103	11/10 → 05/15	1.968	D	M	4	16	CFFB		84001
2.0 TDI 4x4	125	09/08 → 05/15	1.968	D	M	4	16	CBBB, CFGB		81816
	125	09/08 → 05/15	1.968	D	M	4	16	CBBB, CFGB		84011 <b>NEW</b>
2.0 TSI	147	05/10 → 05/15	1.984	B	M	4	16	CCZA		84016 <b>NEW</b>
3.6 FSI 4x4	191	04/09 → 05/15	3.597	B	M	6	24			81866
3.6 V6 4x4	191	11/08 → 05/15	3.580	B	M	6	24	CDVA		81866

**Yeti**

1.2 TSI	77	09/09 →	1.197	B	M	4	8	CBZB		84045 <b>NEW</b>
	81	05/15 →	1.197	B	M	4	16	CYVB		84062 <b>NEW</b>
1.4 TSI	90	06/10 →	1.390	B	M	4	16	CAXA		82097
	92	05/15 →	1.395	B	M	4	16	CZCA		84062 <b>NEW</b>
1.4 TSI 4x4	110	05/15 →	1.395	B	M	4	16	CZDA		84062 <b>NEW</b>

		KW		cm <sup>3</sup>				NO. OF VALVES		
--	--	----	--	-----------------	--	--	--	---------------	--	--

## SKODA

### Yeti

1.6	81	04/14 →	1.598	B	M	4	16	CWVA		84062	
1.6 TDI	77	11/10 →	1.598	D	M	4	16	CAYC		84001	
1.8 TSI 4x4	112	11/09 →	1.798	B	M	4	16	CDAB		84016	
	118	05/09 →	1.798	B	M	4	16	CDAA		84016	
2.0 TDI	81	11/09 →	1.968	D	M	4	16	CFHA, CLCA		84001	
	103	11/11 →	1.968	D	M	4	16	CFHC		84001	
2.0 TDI 4x4	81	11/09 →	1.968	D	M	4	16	CFHF		84001	
	103	05/09 →	1.968	D	M	4	16	CBDB, CFHC, CLCB	M: CBDB	81816	
	103	05/09 →	1.968	D	M	4	16	CBDB, CFHC, CLCB	M: CFHC	84001	
	103	05/09 →	1.968	D	M	4	16	CBDB, CFHC, CLCB		84001	
	103	05/09 →	1.968	D	M	4	16	CBDB, CFHC, CLCB		84011	
	125	11/09 →	1.968	D	M	4	16	CEGA, CFJA	M: CEGA	81816	
	125	11/09 →	1.968	D	M	4	16	CEGA, CFJA	M: CFJA	84001	
125	11/09 →	1.968	D	M	4	16	CEGA, CFJA		84001		
125	11/09 →	1.968	D	M	4	16	CEGA, CFJA		84011		

## SMART

### Cabrio

0.6	40	03/00 → 01/04	599	B	M	3	6	M160.920, M160E6ALB03		84012	
	45	01/01 → 01/04	599	B	M	3	6	M160.920, M160E6ALB05		84012	
	52	06/02 → 01/04	599	B	M	3	6	M160.920		84012	
0.7	45	01/03 → 01/04	698	B	M	3	6	M160.910		84012	
	55	01/03 → 01/04	698	B	M	3	6	M160.910		84012	
0.8 CDI	30	03/01 → 01/04	799	D	M	3	6	OM660.940, OM660DE8LA		84012	

### City-Coupé

0.6	33	07/98 → 01/04	599	B	M	3	6	M160.920, M160E6ALB04		84012	
	40	07/98 → 01/04	599	B	M	3	6	M160.920, M160E6ALB03		84012	
	45	01/01 → 01/04	599	B	M	3	6	M160.920, M160E6ALB05		84012	
	52	06/02 → 01/04	599	B	M	3	6	M160.920		84012	
0.70.7	37	01/03 → 01/04	698	B	M	3	6	M160.910		84012	
	45	01/03 → 01/04	698	B	M	3	6	M160.910		84012	
	55	01/03 → 01/04	698	B	M	3	6	M160.910		84012	
0.8 CDI	30	11/99 → 01/04	799	D	M	3	6	OM660.940, OM660DE8LA		84012	

### CrossBlade

0.6	52	06/02 → 12/03	599	B	M	3	6	M160.920		84012	
-----	----	---------------	-----	---	---	---	---	----------	--	-------	--

**KW**

**cm<sup>3</sup>**

**NO. OF VALVES**

**SMART**
**ForFour I**

1.1	47	02/05 → 06/06	1.124	B	M	3	12	M134.911		82049
	55	01/04 → 06/06	1.124	B	M	3	12	M134.910		82049
1.3	70	01/04 → 06/06	1.332	B	M	4	16	M135.930		82049
1.5	80	01/04 → 06/06	1.499	B	M	4	16	M135.950		82049
	90	01/04 → 06/06	1.499	B	M	4	16	M135.950		82049
1.5 BRABUS	130	05/05 → 06/06	1.468	B	M	4	16	M122.950		82049
1.5 CDI	50	09/04 → 06/06	1.493	D	M	3	12	OM639.939		82017
	70	09/04 → 06/06	1.493	D	M	3	12	OM639.939		82017

**ForFour II**

0.9	66	11/14 →	898	B	M	3	12	M281.910		84003
1.0	45	11/14 →	999	B	M	3	12	M281.920		84003
	52	07/14 →	999	B	M	3	12	M281.920		84003

**ForTwo I Coupé, Cabrio**

0.7	37	01/04 → 01/07	698	B	M	3	6	M160.910		84012	<b>NEW</b>
	45	01/04 → 01/07	698	B	M	3	6	M160.910		84012	<b>NEW</b>
	55	01/04 → 01/07	698	B	M	3	6	M160.910		84012	<b>NEW</b>
0.8 CDI	30	01/04 → 01/07	799	D	M	3	6	OM660.940		84012	<b>NEW</b>
	30	01/04 → 01/07	799	D	M	3	6	OM660.940, OM660DE8LA		84012	<b>NEW</b>

**ForTwo II Coupé, Cabrio**

0.8 CDi	33	01/07 →	799	D	M	3	6	OM660.950		84012	<b>NEW</b>
	40	08/09 →	799	D	M	3	6	OM660.951		84012	<b>NEW</b>

**ForTwo III Coupé, Cabrio**

0.9	66	09/15 →	898	B	M	3	12	M281.910		84003
1.0	45	11/14 →	999	B	M	3	12	M281.920		84003
	52	09/15 →	999	B	M	3	12	M281.920		84003

**Roadster**

0.7	45	04/03 → 11/05	698	B	M	3	6	M160.921		84012	<b>NEW</b>
	45	06/03 → 11/05	698	B	M	3	6	M160.922		84012	<b>NEW</b>
	60	04/03 → 11/05	698	B	M	3	6	M160.921		84012	<b>NEW</b>
	60	04/03 → 11/05	698	B	M	3	6	M160.922		84012	<b>NEW</b>
0.7 Brabus	74	12/03 → 11/05	698	B	M	3	6	M160.923		84012	<b>NEW</b>

**SSANGYONG**
**Korando II, Cabrio**

2.3 D	58	12/96 →	2.299	D	M	4	8	OM601.940		81506
2.9 D	72	11/97 →	2.874	D	M	5	10	MB-OM662		81506
	72	12/96 →	2.874	D	M	5	10	MB-OM662		81506
2.9 TD	88	04/98 →	2.874	D	M	5	10			81506
3.2	156	01/99 →	3.199	B	M	6	24	M104.995		81724
	162	06/97 →	3.199	B	M	6	24	M104.992		81724
	154	12/96 →	3.199	B	M	6	24	M104.995		81724

--	--	--	--	--	--	--	--	--	--

## SSANGYONG

### Musso

2.3 D	59	10/95 →	2.299	D	M	4	8	MB-OM661, OM601.940		81506
2.9 D	73	03/96 →	2.874	D	M	5	10	MB-OM662		81506
2.9 TD	88	04/98 →	2.874	D	M	5	10			81506
3.2	162	06/96 →	3.199	B	M	6	24	M104.992		81724

### Rexton

2.9 TD	88	04/02 →	2.874	D	M	5	10			81506
3.2	162	04/02 →	3.199	B	M	6	24	G32D		81724

## SUBARU

### Justy II

1.3 4x4	63	04/01 → 11/03	1.298	B	M	4	16	G13BB		81858
1.3 GX 4x4	50	10/95 → 11/03	1.298	B	M	4	8	EF13		81858

### Justy III

1.3 AWD	69	09/03 →	1.328	B	M	4	16	M13A		82026
1.5 AWD	73	09/03 →	1.490	B	M	4	16	M15A		82026

### Justy IV

1.0	51	01/07 →	998	B	M	3	12	1KR-FE		82063
-----	----	---------	-----	---	---	---	----	--------	--	-------

### Trezia

1.3	73	03/11 →	1.329	B	M	4	16	1NR-FE, 1NR-FKE		84032
1.4 D	66	03/11 →	1.364	D	M	4	8	1ND-TV		84029

## SUZUKI

### ALTO

1.0	43	01/00 → 06/02	993	B	M	4	16	G10BB		81858
-----	----	---------------	-----	---	---	---	----	-------	--	-------

### Alto III

1.0	39	09/94 → 09/98	993	B	M	4	16	G10BB	01-1991 →	81858
-----	----	---------------	-----	---	---	---	----	-------	-----------	-------

### Alto IV

1.1	46	09/04 → 12/08	1.061	B	M	4	16	F10D, F10DN		81858
-----	----	---------------	-------	---	---	---	----	-------------	--	-------

### Alto V

1.0	50	01/09 →	996	B	M	3	12	K10B		84017
-----	----	---------	-----	---	---	---	----	------	--	-------

### Baleno, Station Wagon

1.3	52	09/96 → 05/02	1.298	B	M	4	8	G13BA		81858
1.3 16V	63	03/97 → 05/02	1.298	B	M	4	16	G13BB		81858
1.3 i 16V	63	07/95 → 05/02	1.298	B	M	4	16	G13BB	01-1994 →	81858
1.6 i 16V	72	07/95 → 05/02	1.590	B	M	4	16	G16B		81790
	73	08/96 → 05/02	1.590	B	M	4	16	G16B		81790
1.6 i 16V 4x4	72	07/95 → 05/02	1.590	B	M	4	16	G16B		81790
1.8 GTX	89	03/96 → 05/02	1.839	B	M	4	16	J18A		81790
1.8 i 16V	89	08/96 → 05/02	1.839	B	M	4	16	J18A		81790
1.9 TD	55	04/98 → 05/02	1.905	D	M	4	8	DHV (XUD9BSD), DHW (XUD9SD)		81642
	55	04/98 → 05/02	1.905	D	M	4	8	DHW (XUD9SD)		81642

	<b>KW</b>		<b>cm<sup>3</sup></b>				<b>NO. OF VALVES</b>			<b>MAGNETI MARELLI</b>
--	-----------	--	-----------------------	--	--	--	----------------------	--	--	------------------------

## SUZUKI

### Cappucino

0.7	47	02/92 → 08/95	657	B	M	3	12	F6A		81783
-----	----	---------------	-----	---	---	---	----	-----	--	-------

### Celerio

1.0	50	03/14 →	998	B	M	3	12	K10B		84017 <b>NEW</b>
-----	----	---------	-----	---	---	---	----	------	--	------------------

### Grand Vitara I

1.6 4x4	69	03/98 → 07/03	1.590	B	M	4	16	G16B		82050
---------	----	---------------	-------	---	---	---	----	------	--	-------

	73	02/00 → 09/02	1.590	B	M	4	16	G16B		82050
--	----	---------------	-------	---	---	---	----	------	--	-------

2.0 HDI 110 16V	80	07/01 → 09/05	1.997	D	M	4	16	RHW, RHZ		81713
-----------------	----	---------------	-------	---	---	---	----	----------	--	-------

### Grand Vitara II

1.6 Trazione integrale	73	09/05 → 02/15	1.586	B	M	4	16	M16A		82050
------------------------	----	---------------	-------	---	---	---	----	------	--	-------

	78	04/05 →	1.586	B	M	4	16	M16A		82050
--	----	---------	-------	---	---	---	----	------	--	-------

1.9 DDiS	95	10/05 → 02/15	1.870	D	M	4	8	F9QB		81868
----------	----	---------------	-------	---	---	---	---	------	--	-------

	95	10/05 → 02/15	1.870	D	M	4	8	F9QB		84006
--	----	---------------	-------	---	---	---	---	------	--	-------

### Ignis I

1.3	61	10/00 → 09/03	1.328	B	AM	4	16	M13A	M: M13A	82026
-----	----	---------------	-------	---	----	---	----	------	---------	-------

1.3 4WD	61	10/00 → 09/03	1.328	B	M	4	16	M13A		82026
---------	----	---------------	-------	---	---	---	----	------	--	-------

### Ignis II

1.3	69	09/03 →	1.328	B	M	4	16	M13A		82026
-----	----	---------	-------	---	---	---	----	------	--	-------

1.3 4x4	69	09/03 →	1.328	B	M	4	16	M13A		82026
---------	----	---------	-------	---	---	---	----	------	--	-------

1.3 DDiS	51	09/03 →	1.248	D	M	4	16	Z13DT		81862
----------	----	---------	-------	---	---	---	----	-------	--	-------

1.5	73	09/03 →	1.490	B	M	4	16	M15A		82026
-----	----	---------	-------	---	---	---	----	------	--	-------

1.5 4x4	73	09/03 →	1.490	B	M	4	16	M15A		82026
---------	----	---------	-------	---	---	---	----	------	--	-------

1.5 Sport	80	12/03 →	1.490	B	M	4	16	M15A		82026
-----------	----	---------	-------	---	---	---	----	------	--	-------

### Jimny

1.3 16V	59	09/98 →	1.298	B	M	4	16	G13BB		81789
---------	----	---------	-------	---	---	---	----	-------	--	-------

	60	02/01 →	1.328	B	M	4	16	M13A		82026
--	----	---------	-------	---	---	---	----	------	--	-------

1.3 16V 4WD	59	09/98 →	1.298	B	M	4	16	G13BB		81789
-------------	----	---------	-------	---	---	---	----	-------	--	-------

	60	02/01 →	1.328	B	M	4	16	M13A	M: G13BB	82026
--	----	---------	-------	---	---	---	----	------	----------	-------

1.3 16V 4x4	63	08/05 →	1.328	B	M	4	16	M13A		82026
-------------	----	---------	-------	---	---	---	----	------	--	-------

1.3 4WD	62	05/14 →	1.328	B	M	4	16	M13A		82026
---------	----	---------	-------	---	---	---	----	------	--	-------

1.3 4x4	63	09/98 → 08/00	1.298	B	M	4	16	G13BB		81789
---------	----	---------------	-------	---	---	---	----	-------	--	-------

	65	09/00 → 08/02	1.328	B	M	4	16	M13A		82026
--	----	---------------	-------	---	---	---	----	------	--	-------

1.5 DDiS 4WD	48	12/03 →	1.461	D	M	4	8	K9K700		81810
--------------	----	---------	-------	---	---	---	---	--------	--	-------

1.5 DDiS 4x4	63	08/05 →	1.461	D	M	4	16	K9K266		84007
--------------	----	---------	-------	---	---	---	----	--------	--	-------

### Liana

1.3	66	03/02 →	1.328	B	M	4	16	M13A		82026
-----	----	---------	-------	---	---	---	----	------	--	-------

1.4 DDiS	66	04/04 →	1.398	D	M	4	16	8HY		81798
----------	----	---------	-------	---	---	---	----	-----	--	-------

1.6	76	07/01 → 12/07	1.586	B	AM	4	16	M16A		82026
-----	----	---------------	-------	---	----	---	----	------	--	-------

	76	03/02 →	1.586	B	M	4	16	M16A		82026
--	----	---------	-------	---	---	---	----	------	--	-------

1.6 4WD	76	07/01 → 12/07	1.586	B	AM	4	16	M16A		82026
---------	----	---------------	-------	---	----	---	----	------	--	-------

	76	03/02 →	1.586	B	M	4	16	M16A		82026
--	----	---------	-------	---	---	---	----	------	--	-------

	78	04/02 →	1.586	B	M	4	16	M16A		82026
--	----	---------	-------	---	---	---	----	------	--	-------

1.6 i	78	04/02 →	1.586	B	M	4	16	M16A		82026
-------	----	---------	-------	---	---	---	----	------	--	-------

		<b>KW</b>		<b>cm<sup>3</sup></b>				<b>NO. OF VALVES</b>		
--	--	-----------	--	-----------------------	--	--	--	----------------------	--	--

## SUZUKI

### Samurai

1.3	47	11/88 → 12/04	1.324	B	M	4	8	G13A		81789
1.3 Trazione integrale	51	11/88 → 12/04	1.298	B	M	4	8	G13BA		81789
	44	11/88 → 12/04	1.324	B	M	4	8	G13A		81789
1.9 TD	46	11/98 → 12/04	1.905	D	M	4	8	XUD9		81642

### SJ 413

1.3	44	08/86 → 08/90	1.324	B	M	4	8	G13A		81789
	47	09/84 → 08/90	1.324	B	M	4	8	G13A		81789

### Splash

1.0	48	01/08 →	996	B	M	3	12	K10B		84017	
	50	06/11 →	996	B	M	3	12	K10B		84017	
1.2	63	01/08 →	1.242	B	M	4	16	K12B		84017	
1.2 VVT	66	06/11 →	1.242	B	M	4	16	K12B		84017	
	69	09/10 →	1.242	B	M	4	16	K12B		84017	
1.3 CDTI	55	01/08 →	1.248	D	M	4	16	D13A, Z13DTJ		81862	

### Swift II, Cabrio

1.0	37	03/89 → 05/01	993	B	M	3	6	G10A		81858
1.0 i	39	01/95 → 12/05	993	B	M	3	6	G10A		81858
	40	03/89 → 12/91	993	B	M	3	6	G10A		81858
1.3	50	03/89 → 05/01	1.298	B	M	4	8	G13A		81858
	50	03/89 → 05/01	1.324	B	M	4	8	G13A		81858
	52	03/89 → 12/91	1.324	B	M	4	8	G13A		81858
1.3 4WD	50	03/89 → 05/01	1.324	B	M	4	8	G13A		81858
	52	10/89 → 12/91	1.324	B	M	4	8	G13A		81858
1.3 GTi	74	03/89 → 05/01	1.298	B	M	4	16	G13B		81858
1.3 i	50	09/91 → 10/96	1.298	B	M	4	8	G13BA		81858
1.6	70	11/89 → 12/91	1.590	B	M	4	16	G16B		81790
1.6 4WD	70	11/89 → 12/91	1.590	B	M	4	16	G16B		81790
1.6 i	68	01/90 → 05/01	1.590	B	M	4	16	G16B		81790
1.6 i 4WD	68	01/90 → 05/01	1.590	B	M	4	16	G16B		81790

### Swift III

1.3	68	02/05 →	1.328	B	M	4	16	M13A		82026
1.3 4x4	66	01/06 →	1.328	B	M	4	16	M13A		82026
	68	02/05 →	1.328	B	M	4	16	M13A		82026
1.3 DDiS	51	08/05 →	1.248	D	M	4	16	Z13DT		81862
	55	08/05 →	1.248	D	M	4	16	D13A, Z13DTJ		81862
1.5	75	02/05 →	1.490	B	M	4	16	M15A		82026
1.5 4x4	74	02/05 →	1.490	B	M	4	16	M15A		82026
1.6	92	05/06 →	1.586	B	M	4	16	M16A		82026

### Swift IV

1.2	66	10/10 →	1.242	B	M	4	16	K12B		84017	
	69	10/10 →	1.242	B	M	4	16	K12B		84017	
1.2 4x4	66	10/10 →	1.242	B	M	4	16	K12B		84017	
	69	10/10 →	1.242	B	M	4	16	K12B		84017	
1.3 DDiS	55	10/10 →	1.248	D	M	4	16	D13A		81862	

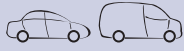
**KW**

**cm<sup>3</sup>**

**NO. OF VALVES**

**SUZUKI**
**Swift IV**

1.6	100	01/12 →	1.586	B	M	4	16	M16A		82026
-----	-----	---------	-------	---	---	---	----	------	--	-------

**SX4**

1.5	73	06/06 →	1.490	B	M	4	16	M15A		82026
	74	06/06 →	1.586	B	M	4	16	M16A		82026
1.6	75	10/07 →	1.586	B	M	4	16	M16A		82026
	79	10/07 →	1.586	B	M	4	16	M16A		82026
1.6 DDiS	66	04/07 →	1.560	D	M	4	16	9HX		81869
1.6 VVT	79	06/06 →	1.586	B	M	4	16	M16A		82026
	88	07/09 →	1.586	B	M	4	16	M16A		82026
1.6 VVT 4x4	79	06/06 →	1.586	B	M	4	16	M16A		82026
	88	07/09 →	1.586	B	M	4	16	M16A		82026
1.9 DDiS	88	06/06 →	1.910	D	M	4	8	D19AA		81352
1.9 DDiS 4x4	88	06/06 →	1.910	D	M	4	8	D19AA		81352
2.0 DDiS	99	07/09 →	1.956	D	M	4	16	D20AA		81872
2.0 DDiS 4x4	99	07/09 →	1.956	D	M	4	16	D20AA		81872

**Vitara**

1.6	88	02/15 →	1.586	B	M	4	16	M16A		82026
	59	07/88 → 01/95	1.589	B	M	4	8	G16A (8V)		81790
1.6 i 16V	71	07/90 → 03/99	1.589	B	M	4	16	G16B		81790
1.6 i 16V Trazione integrale	71	07/90 → 03/98	1.589	B	M	4	16	G16B		81790
1.6 Trazione integrale	59	07/88 → 03/98	1.589	B	M	4	8	G16A (8V)		81790
	60	07/88 → 12/91	1.589	B	M	4	8	G16A (8V)		81790
1.9 D	50	01/95 → 03/98	1.905	D	M	4	8	XUD9A		81642
	55	08/96 → 03/99	1.905	D	M	4	8	XUD9SD		81642
1.9 D Trazione integrale	50	01/95 → 03/98	1.905	D	M	4	8	XUD9A		81642
	55	08/96 → 03/98	1.905	D	M	4	8	XUD9SD		81642
2.0 V6 24V Trazione integrale	100	12/94 → 03/98	1.998	B	M	6	24	H20A		81790

**Wagon R+ II**

1.3	56	05/00 → 12/04	1.298	B	AM	4	16	G13BB		81858
	65	08/01 →	1.328	B	M	4	16	M13A		82026
	69	09/03 →	1.328	B	M	4	16	M13A		82026
1.3 4WD	56	10/01 →	1.298	B	M	4	16	G13BB		81858
	69	09/03 →	1.328	B	M	4	16	M13A		82026
1.3 DDiS	51	09/03 →	1.248	D	M	4	16	Z13DT		81862

**X-90**

1.6 i 16V	71	09/95 → 12/97	1.590	B	M	4	16	G16B		81790
1.6 i 16V 4x4	71	09/95 → 12/97	1.590	B	M	4	16	G16B		81790



**KW**

**cm<sup>3</sup>**

**NO. OF VALVES**

**TOYOTA**
**Auris I, Van**

1.33 Dual-VVTi	73	01/10 → 09/12	1.329	B	M	4	16	1NR-FE		84032	<b>NEW</b>
	74	05/09 → 09/12	1.329	B	M	4	16	1NR-FE		84032	<b>NEW</b>
1.4 D-4D	66	03/07 → 09/12	1.364	D	M	4	8	1ND-TV	→ 01-2009	81821	
	66	03/07 → 09/12	1.364	D	M	4	8	1ND-TV	02-2009 →	84029	<b>NEW</b>
1.4 VVTi	71	03/07 → 09/12	1.398	B	M	4	16	4ZZ-FE		82012	
1.6	97	05/09 → 09/12	1.598	B	M	4	16	1ZR-FAE		84030	<b>NEW</b>
1.6 VVTi	91	03/07 → 09/12	1.598	B	M	4	16	1ZR-FE		84030	<b>NEW</b>
1.8	106	02/09 → 09/12	1.798	B	M	4	16	2ZR-FAE		84030	<b>NEW</b>
	108	02/09 → 09/12	1.798	B	M	4	16	2ZR-FAE		84030	<b>NEW</b>
1.8 4WD	100	02/09 → 09/12	1.798	B	M	4	16	2ZR-FAE		84030	<b>NEW</b>
2.0 D-4D	93	03/07 → 09/12	1.998	D	M	4	16	1AD-FTV		82071	
2.2 D	130	03/07 → 09/12	2.231	D	M	4	16	2AD-FHV		82071	

**Auris II, Touring Sports, Van**

1.3	73	10/12 →	1.329	B	M	4	16	1NR-FE		84032	<b>NEW</b>
1.4 D-4D	66	10/12 →	1.364	D	M	4	8	1ND-TV		84029	<b>NEW</b>
1.6	97	10/12 →	1.598	B	M	4	16	1ZR-FAE		84030	<b>NEW</b>
1.6 D4-D	82	04/15 →	1.598	D	M	4	16	1WW		84026	<b>NEW</b>

**Avenis I, Liftback, Station Wagon**

1.6	74	09/97 → 10/00	1.587	B	M	4	16	4A-FE	(+)COP	81767	
	81	09/97 → 10/00	1.587	B	M	4	16	4A-FE	(+)COP	81767	
1.6 VVT-i	81	10/00 → 02/03	1.598	B	M	4	16	3ZZ-FE		82012	
1.8	81	09/97 → 10/00	1.762	B	M	4	16	7A-FE	(+)COP, OEM: AISIN	81769	
	81	09/97 → 10/00	1.762	B	M	4	16	7A-FE	(+)COP, OEM: SEM	81768	
1.8 VVT-i	95	10/00 → 02/03	1.794	B	AM	4	16	1ZZ-FE		82012	
2.0	94	09/97 → 10/00	1.998	B	M	4	16	3S-FE	(-)COP, 01-1997 →	81770	
2.0 D	85	09/02 → 02/03	1.995	D	M	4	16	1CD-FTV		82022	
2.0 D-4D	81	10/99 → 02/03	1.995	D	M	4	16	1CD-FTV		82022	
2.0 VVT-i	110	10/00 → 02/03	1.998	B	AM	4	16	1AZ-FSE		82055	

**Avenis II, Liftback, Station Wagon**

1.6 VVT-i	81	04/03 → 11/08	1.598	B	M	4	16	3ZZ-FE		82012	
1.8	95	04/03 → 11/08	1.794	B	M	4	16	1ZZ-FE		82012	
2.0	108	04/03 → 11/08	1.998	B	M	4	16	1AZ-FSE		82055	
2.0 D-4D	85	04/03 → 11/08	1.995	D	M	4	16	1CD-FTV	→ 06-2004	82022	
	85	04/03 → 11/08	1.995	D	M	4	16	1CD-FTV	07-2004 →	82044	
	93	03/06 → 11/08	1.998	D	M	4	16	1AD-FTV		82071	
2.0 VVTi	114	04/03 → 11/08	1.998	B	M	4	16	1AZ-FE		82055	
2.2 D-4D	110	10/05 → 11/08	2.231	D	M	4	16	2AD-FTV		82071	
2.2 D-CAT	130	07/05 → 11/08	2.231	D	M	4	16	2AD-FHV		82071	
2.4	120	10/03 → 11/08	2.362	B	M	4	16	2AZ-FSE		82055	
	125	09/03 → 11/08	2.362	B	M	4	16	2AZ-FSE		82055	



## TOYOTA

### Avensis III, Liftback, Station Wagon

1.6	97	02/09 →	1.598	B	M	4	16	1ZR-FAE		84030	<b>NEW</b>
1.8	108	02/09 →	1.798	B	M	4	16	2ZR-FAE		84030	<b>NEW</b>
2.0	112	02/09 →	1.987	B	M	4	16	3ZR-FAE, 3ZR-FE		84030	<b>NEW</b>
2.0 D-4D	93	02/09 →	1.998	D	M	4	16	1AD-FTV	→ 11-2011	82071	
	110	02/09 →	2.231	D	M	4	16	2AD-FHV, 2AD-FTV		82071	
	130	02/09 →	2.231	D	M	4	16	2AD-FHV		82071	

### Avensis Verso

2.0 D-4D	85	08/01 → 08/05	1.995	D	M	4	16	1CD-FTV		82022	
2.0 VVT-i	110	08/01 → 11/09	1.998	B	AM	4	16	1AZ-FE		82055	
2.4 VVTi GLS	115	10/03 → 11/09	2.362	B	M	4	16	2AZ-FE		82055	

### Aygo I

1.0	50	07/05 →	998	B	M	3	12	1KR-FE		82063	
1.0 GPL	50	07/05 →	998		M	3	12	1KR-FE		82063	
1.4 HDi	40	07/05 → 08/10	1.398	D	M	4	8	2WZ-TV		81798	

### Aygo II

1.0	51	05/14 →	998	B	M	3	12	1KR-FE		84054	<b>NEW</b>
1.2	60	05/14 →	1.199	B	M	3	12	1PP		84054	<b>NEW</b>

### Camry I, Liftback, Station Wagon

2.0	94	11/86 → 05/91	1.998	B	M	4	16	3S-FE	(-)COP	81770	
2.0 Gli 16V	89	11/86 → 05/91	1.998	B	M	4	16	3S-FE	(-)COP	81770	

### Camry II, Liftback, Station Wagon

2.2	100	06/91 → 08/96	2.164	B	M	4	16	5S-FE	(-)COP	81770	
-----	-----	---------------	-------	---	---	---	----	-------	--------	-------	--

### Camry III, Station Wagon

2.2	93	11/00 → 11/01	2.164	B	M	4	16	5S-FE	(-)COP	81770	
	96	08/96 → 11/01	2.164	B	AM	4	16	5S-FE	(-)COP, 01-1993 →	81770	
3.0 24V	140	08/96 → 11/01	2.995	B	A	6	24	1MZ-FE		82051	
3.0 V6	135	08/96 → 11/01	2.995	B	M	6	24	1MZ-FE		82051	

### Camry IV

2.0 VVTi	110	08/01 → 11/06	1.998	B	M	4	16	1AZ-FE		82055	
2.4 VVT-i	112	11/01 → 11/06	2.362	B	AM	4	16	2AZ-FE		82055	
2.4 VVTi Hybrid	105	01/06 → 11/06	2.362	B	M	4	16	2AZ-FXE		82055	
3.0 V6	137	11/01 → 11/06	2.995	B	A	6	24	1MZ-FE		82051	

### Camry V

2.4 VVTi	116	01/06 → 09/11	2.362	B	M	4	16	2AZ-FE		82055	
	123	01/06 → 09/11	2.362	B	M	4	16	2AZ-FE		82055	

### Carina E (T19), Station Wagon

1.5 SG	77	04/92 → 09/97	1.498	B	M	4	16	5A-FE	(-)COP	81771	
--------	----	---------------	-------	---	---	---	----	-------	--------	-------	--

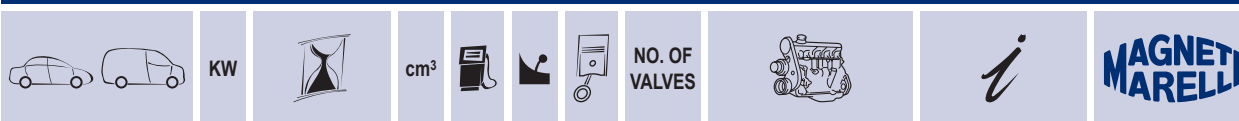
**TOYOTA**
**Carina E (T19), Station Wagon**

1.6	73	12/93 → 09/97	1.587	B	M	4	16	4A-FE	(-)COP	81815
	73	12/93 → 09/97	1.587	B	M	4	16	4A-FE	(+)COP, → 12-1994	81766
	73	12/93 → 09/97	1.587	B	M	4	16	4A-FE	(+)COP, 01-1995 →	81767
	73	01/95 → 09/97	1.587	B	M	4	16	4A-FE	(+)COP	81767
	78	10/95 → 09/97	1.587	B	M	4	16	4A-FE	(+)COP	81767
	79	01/93 → 09/97	1.587	B	M	4	16	4A-FE	(-)COP, → 12-1994	81815
	79	01/93 → 09/97	1.587	B	M	4	16	4A-FE	(+)COP, → 12-1994	81766
	79	01/93 → 09/97	1.587	B	M	4	16	4A-FE	(+)COP, 01-1995 →	81767
	85	12/93 → 09/97	1.587	B	M	4	16	4A-FE	(-)COP	81815
	85	12/93 → 09/97	1.587	B	M	4	16	4A-FE	(+)COP, → 12-1994	81766
	85	12/93 → 09/97	1.587	B	M	4	16	4A-FE	(+)COP, 01-1995 →	81767
1.6 16V	78	10/95 → 09/97	1.587	B	M	4	16	4A-FE	(+)COP	81767
	85	12/94 → 09/97	1.587	B	M	4	16	4A-FE	(+)COP	81767
1.6 GLI	79	04/92 → 09/97	1.587	B	M	4	16	4A-FE	(-)COP	81815
	79	04/92 → 09/97	1.587	B	M	4	16	4A-FE	(+)COP, → 12-1994	81766
	79	04/92 → 09/97	1.587	B	M	4	16	4A-FE	(+)COP, 01-1995 →	81767
1.6 i	73	02/95 → 09/97	1.587	B	M	4	16	4A-FE	(+)COP	81767
1.8	85	04/92 → 09/97	1.762	B	M	4	16	7A-FE	(-)COP, → 12-1994	81770
	85	04/92 → 09/97	1.762	B	M	4	16	7A-FE	(+)COP, 01-1995 →, → 12-1995	81768
	85	04/92 → 09/97	1.762	B	M	4	16	7A-FE	(+)COP, 01-1996 →	81769
	79	01/95 → 09/97	1.762	B	M	4	16	7A-FE	(+)COP, → 12-1995	81768
	79	01/95 → 09/97	1.762	B	M	4	16	7A-FE	(+)COP, 01-1996 →	81769
1.8 GL	92	10/94 → 09/97	1.762	B	M	4	16	7A-FE	(+)COP, → 12-1995	81768
	92	10/94 → 09/97	1.762	B	M	4	16	7A-FE	(+)COP, 01-1996 →	81769
1.8 i	79	02/95 → 09/97	1.762	B	M	4	16	7A-FE	(+)COP	81768
1.8 i 16V	79	01/95 → 09/97	1.762	B	M	4	16	7A-FE	(+)COP, → 12-1995	81768
	79	01/95 → 09/97	1.762	B	M	4	16	7A-FE	(+)COP, 01-1996 →	81769
2.0	98	01/93 → 09/97	1.998	B	M	4	16	3S-FE	(-)COP	81770
2.0 GLI	98	04/92 → 09/97	1.998	B	M	4	16	3S-FE	(-)COP	81770
	116	04/92 → 02/94	1.998	B	M	4	16	3S-GE	(-)COP	81770
2.0 GTi 16V	129	03/94 → 09/97	1.998	B	M	4	16	3S-GE	(-)COP	81770
2.0 i	93	12/93 → 09/97	1.998	B	M	4	16	3S-FE	(-)COP	81770
<b>Celica V</b>										
1.6 STI	77	10/89 → 11/93	1.587	B	M	4	16	4A-FE	(-)COP	81815
	77	10/89 → 11/93	1.587	B	M	4	16	4A-FE	(+)COP	81766
<b>Celica VI</b>										
1.8 i 16V	85	11/93 → 11/99	1.762	B	M	4	16	7A-FE	(+)COP	81769
<b>Celica VII</b>										
1.8 16V VT-i	105	08/99 → 07/05	1.794	B	M	4	16	1ZZ-FE		82012

**KW**

**cm<sup>3</sup>**

**NO. OF VALVES**

**MAGNETI MARELLI**
**TOYOTA**
**Corolla V, Liftback, Station Wagon, Compact**

1.3 XLI	55	09/95 → 04/97	1.332	B	M	4	16	4E-FE	(-)COP	81771
	65	07/92 → 04/97	1.332	B	M	4	16	4E-FE	(-)COP	81771
1.3 XLI 16V	65	07/92 → 09/95	1.332	B	M	4	16	4E-FE	(-)COP	81771
1.6 GLI	84	07/92 → 04/97	1.587	B	M	4	16	4A-FE	(-)COP	81815
	84	07/92 → 04/97	1.587	B	M	4	16	4A-FE	(+)COP	81766
1.6 Si	84	09/95 → 04/97	1.587	B	M	4	16	4A-FE	(-)COP	81815
	84	09/95 → 04/97	1.587	B	M	4	16	4A-FE	(+)COP	81766
1.8 16V 4WD	81	09/95 → 04/97	1.762	B	M	4	16	7A-FE	(+)COP	81769
1.8 GT	86	11/92 → 05/95	1.762	B	M	4	16	7A-FE	(+)COP	81769

**Corolla Verso**

1.4 D-4D	66	03/04 → 03/09	1.364	D	M	4	8	1ND-TV	→ 01-2009	81821
	66	03/04 → 03/09	1.364	D	M	4	8	1ND-TV	02-2009 →	84029 <b>NEW</b>
1.6	81	04/04 → 03/09	1.598	B	M	4	16	3ZZ-FE		82012
1.8	95	04/04 → 03/09	1.794	B	M	4	16	1ZZ-FE		82012
2.0 D-4D	85	04/04 → 03/09	1.995	D	M	4	16	1CD-FTV		82044
2.2 D-4D	100	10/05 → 03/09	2.231	D	M	4	16	2AD-FTV		82071
	130	10/05 → 03/09	2.231	D	M	4	16	2AD-FHV		82071

**Corolla VI, Liftback, Station Wagon, Compact**

1.3	55	05/97 → 10/01	1.295	B	M	4	12	2E	(-)COP	81771
1.4	63	04/97 → 02/00	1.332	B	M	4	16	4E-FE	(-)COP	81771
	71	02/00 → 01/02	1.398	B	M	4	16	4ZZ-FE	11-2001 →	82012
	71	02/00 → 01/02	1.398	B	M	4	16	4ZZ-FE		82012
1.4 16V	71	02/00 → 11/01	1.398	B	M	4	16	4ZZ-FE	11-2001 →	82012
1.6	81	04/97 → 02/00	1.587	B	M	4	16	4A-FE	(-)COP	81815
	81	04/97 → 02/00	1.587	B	M	4	16	4A-FE	(+)COP	81766
	81	02/00 → 01/02	1.598	B	M	4	16	3ZZ-FE		82012
1.6 16V	81	02/00 → 11/01	1.598	B	M	4	16	3ZZ-FE		82012
1.6 Aut.	79	04/97 → 02/00	1.587	B	A	4	16	4A-FE	(-)COP	81815
	79	04/97 → 02/00	1.587	B	M	4	16	4A-FE	(-)COP	81815
	79	04/97 → 02/00	1.587	B	A	4	16	4A-FE	(+)COP	81766
	79	04/97 → 02/00	1.587	B	M	4	16	4A-FE	(+)COP	81766
1.8	81	10/97 → 10/01	1.762	B	M	4	16	7A-FE	(+)COP	81769
1.8 4WD	81	04/97 → 10/01	1.762	B	M	4	16	7A-FE	(+)COP	81769
2.0 D-4D	66	09/00 → 11/01	1.995	D	M	4	16	1CD-FTV		82022

**Corolla VII, Liftback, Station Wagon, Verso**

1.4 D	66	07/04 → 02/07	1.364	D	M	4	8	1ND-TV		81809
1.4 D4-D	66	07/04 → 02/07	1.364	D	M	4	8	1ND-TV		81809
1.4 D-4D	66	07/04 → 07/07	1.364	D	M	4	8	1ND-TV		81809
1.4 VVT-i	71	01/02 → 12/06	1.398	B	M	4	16	4ZZ-FE		82012
1.6 VVT-i	81	01/02 → 12/06	1.598	B	M	4	16	3ZZ-FE		82012
1.81.8	92	05/02 → 05/04	1.794	B	M	4	16	1ZZ-FE		82012
	96	03/01 → 07/05	1.794	B	M	4	16	1ZZ-FE		82012
	100	06/04 → 02/07	1.794	B	M	4	16	1ZZ-FE		82012
1.8 4WD	100	12/01 → 02/07	1.794	B	M	4	16	1ZZ-FE		82012

**KW**

**cm<sup>3</sup>**

**NO. OF VALVES**

**TOYOTA**
**Corolla VII, Liftback, Station Wagon, Verso**

1.8 4x4	94	06/07 → 07/07	1.794	B	M	4	16	1ZZ-FE		82012
1.8 VVTi	100	06/04 → 02/07	1.794	B	M	4	16	1ZZ-FE		82012
1.8 VVT-i	99	01/02 → 05/04	1.794	B	A	4	16	1ZZ-FE		82012
2.0 D-4D	66	01/02 → 02/07	1.995	D	M	4	16	1CD-FTV	→ 06-2004	82022
	66	01/02 → 02/07	1.995	D	M	4	16	1CD-FTV	07-2004 →	82044
	66	01/02 → 12/06	1.995	D	M	4	16	1CD-FTV		82022
	85	04/04 → 02/07	1.995	D	M	4	16	1CD-FTV		82044
	85	06/04 → 07/07	1.995	D	M	4	16	1CD-FTV		82022
	81	01/02 → 12/06	1.995	D	M	4	16	1CD-FTV		82022
85	05/03 → 02/07	1.995	D	M	4	16	1CD-FTV		82022	

**Corolla VIII, Hatchback, Station Wagon**

1.33	74	01/07 →	1.329	B	M	4	16	1NR-FE		84032	<b>NEW</b>
1.4 D-4D	66	01/07 →	1.364	D	M	4	8	1ND-TV	→ 01-2009	81821	
	66	01/07 →	1.364	D	M	4	8	1ND-TV	02-2009 →	84029	<b>NEW</b>
1.4 VVT-i	71	01/07 →	1.398	B	M	4	16	4ZZ-FE		82012	
1.6	97	01/09 →	1.598	B	M	4	16	1ZR-FAE, 1ZR-FE		84030	<b>NEW</b>
1.6 Dual VVTi	91	01/07 →	1.598	B	M	4	16	1ZR-FE		84030	<b>NEW</b>
1.6 VVTi	90	10/12 →	1.598	B	M	4	16	1ZR-FE		84030	<b>NEW</b>
2.0 D-4D	93	01/07 →	1.998	D	M	4	16	1AD-FTV		82071	
	130	11/06 →	2.231	D	M	4	16	2AD-FHV		82071	

**Corolla IX, Hatchback, Station Wagon**

1.3	73	06/13 →	1.329	B	M	4	16	1NR-FE		84032	<b>NEW</b>
1.4 D-4D	66	06/13 →	1.364	D	M	4	8	1ND-TV		84029	<b>NEW</b>
1.6	97	06/13 →	1.598	B	M	4	16	1ZR-FAE		84030	<b>NEW</b>
1.8 VVTi	103	06/13 →	1.798	B	M	4	16	2ZR-FBE, 2ZR-FE		84030	<b>NEW</b>

**IQ**

1.0	50	01/09 →	998	B	M	3	12	1KR-FE		84031	<b>NEW</b>
1.4 D-4D	66	01/09 →	1.364	D	M	4	8	1ND-TV		84028	<b>NEW</b>

**MR 2 III**

1.8 16V VT-i	103	10/99 → 06/07	1.794	B	M	4	16	1ZZ-FE		82012
--------------	-----	---------------	-------	---	---	---	----	--------	--	-------

**Paseo II**

1.5	66	10/96 → 01/98	1.497	B	M	4	16	5E-FE	(-)COP	81771
1.5 16V	66	08/95 → 07/99	1.497	B	M	4	16	5E-FE	(-)COP	81771

**Picnic I**

2.0	90	01/01 → 12/01	1.998	B	M	4	16	3S-FE	(-)COP	81770
2.0 16V	94	05/96 → 12/01	1.998	B	M	4	16	3S-FE	(-)COP	81770

**Previa II**

2.0 D-4D	85	03/01 → 01/06	1.995	D	M	4	16	1CD-FTV		82022
2.4	115	08/00 → 01/06	2.362	B	M	4	16	2AZ-FE		82055
2.4 4WD	96	07/02 → 12/05	2.362	B	M	4	16	2AZ-FXE		82055

**Previa III**

2.4	125	10/05 →	2.362	B	M	4	16	2AZ-FE		82055
-----	-----	---------	-------	---	---	---	----	--------	--	-------

**Prius I**

1.5 Hybrid	53	05/00 → 01/04	1.497		A	4	16	1NZ-FXE		81809
------------	----	---------------	-------	--	---	---	----	---------	--	-------

**KW**

**cm<sup>3</sup>**

**NO. OF VALVES**

**TOYOTA**
**Prius II**

1.5	57	08/03 → 03/09	1.497		M	4	16	1NZ-FXE		81809
-----	----	---------------	-------	--	---	---	----	---------	--	-------

**RAV 4 I**

2.0 16V 4WD	94	12/97 → 06/00	1.998	B	M	4	16	3S-FE	(-)COP	81770
2.0 4WD	95	06/94 → 06/00	1.998	B	M	4	16	3S-FE	(-)COP	81770

**RAV 4 II**

1.8 VVTi	92	08/00 → 11/05	1.794	B	M	4	16	1ZZ-FE		82012
2.0 D-4D 4WD	85	09/01 → 11/05	1.995	D	M	4	16	1CD-FTV		82022
2.0 VVTi 4WD	110	06/00 → 11/05	1.998	B	M	4	16	1AZ-FE		82055
2.4 VVTi 4WD	112	08/03 → 11/05	2.362	B	M	4	16	2AZ-FE		82055

**RAV 4 III**

2.0	116	12/08 →	1.987	B	M	4	16	3ZR-FAE		84030	<b>NEW</b>
2.0 4WD	116	12/08 →	1.987	B	M	4	16	3ZR-FAE		84030	<b>NEW</b>
2.0 VVT-i	109	03/09 →	1.987	B	M	4	16	3ZR-FAE		84030	<b>NEW</b>
2.0 VVT-i 4WD	109	03/09 →	1.987	B	M	4	16	3ZR-FAE		84030	<b>NEW</b>
	112	03/06 →	1.998	B	M	4	16	1AZ-FE		82055	
2.2 D-4D	110	12/08 →	2.231	D	M	4	16	2AD-FHV, 2AD-FTV		82071	
2.2 D-4D 4WD	100	03/06 →	2.231	D	M	4	16	2AD-FTV		82071	
	110	12/08 →	2.231	D	M	4	16	2AD-FHV, 2AD-FTV		82071	
2.2 D-CAT 4WD	130	03/06 →	2.231	D	M	4	16	2AD-FHV		82071	
2.4 VVTi	125	11/05 →	2.362	B	M	4	16	2AZ-FE		82055	
2.4 VVTi 4WD	125	11/05 →	2.362	B	M	4	16	2AZ-FE		82055	

**RAV 4 IV**

2.0 D-4D	105	10/15 →	1.995	D	M	4	16	2WW		84026	<b>NEW</b>
2.0 VVT-i	107	12/12 →	1.987	B	M	4	16	3ZR-FE		84030	<b>NEW</b>
2.0 VVT-i 4WD	111	12/12 →	1.987	B	M	4	16	3ZR-FAE		84030	<b>NEW</b>
2.2 D4-D 4WD	110	12/12 →	2.231	D	M	4	16	2AD-FHV, 2AD-FTV		82071	

**Starlet IV**

1.3	55	04/96 → 03/99	1.332	B	M	4	16	4E-FE	(-)COP	81771
-----	----	---------------	-------	---	---	---	----	-------	--------	-------

**Urban Cruiser**

1.33	73	04/10 →	1.329	B	M	4	16	1NR-FE		84032	<b>NEW</b>
	74	04/09 →	1.329	B	M	4	16	1NR-FE		84032	<b>NEW</b>
1.4 D-4D	66	04/09 →	1.364	D	M	4	8	1ND-TV		84029	<b>NEW</b>
1.4 D-4D 4WD	66	04/09 →	1.364	D	M	4	8	1ND-TV		84029	<b>NEW</b>
1.5 VVTi	80	07/07 →	1.497	B	M	4	16	1NZ-FE		81809	
1.5 VVTi 4WD	76	04/09 →	1.497	B	M	4	16	1NZ-FE		81809	

**Verso**

1.6	97	04/09 →	1.598	B	M	4	16	1ZR-FAE		84030	<b>NEW</b>
1.6 D4-D	82	11/13 →	1.598	D	M	4	16	1WW		84026	<b>NEW</b>
1.8	108	04/09 →	1.798	B	M	4	16	2ZR-FAE		84030	<b>NEW</b>
2.0 D-4D	91	11/12 →	1.998	D	M	4	16	1AD-FTV		82071	
	93	04/09 →	1.998	D	M	4	16	1AD-FTV		82071	
2.2 D-4D	110	04/09 →	2.231	D	M	4	16	2AD-FHV		82071	
2.2 D-CAT	130	04/09 →	2.231	D	M	4	16	2AD-FHV		82071	



KW



cm<sup>3</sup>



NO. OF VALVES



## TOYOTA

### Verso S

1.33	70	11/10 →	1.329	B	M	4	16	1NR-FE		84032	<b>NEW</b>
	73	11/10 →	1.329	B	M	4	16	1NR-FE		84032	<b>NEW</b>
1.4 D4-D	66	11/10 →	1.364	D	M	4	8	1ND-TV		84029	<b>NEW</b>
1.5	80	11/10 →	1.497	B	M	4	16	1NZ-FE		81809	
1.5 4WD	76	11/10 →	1.497	B	M	4	16	1NZ-FE		81809	

### Yaris I

1.0 16V	48	03/03 → 09/05	998	B	M	4	16	1SZ-FE	Flange: 3 holes	81808	
	48	03/03 → 09/05	998	B	M	4	16	1SZ-FE	Flange: 4 holes	82048	
	50	04/99 → 09/05	998	B	M	4	16	1SZ-FE	Flange: 3 holes	81808	
	50	04/99 → 09/05	998	B	M	4	16	1SZ-FE	Flange: 4 holes	82048	
1.3	64	04/02 → 09/05	1.298	B	M	4	16	2SZ-FE		81809	
1.3 16V	63	11/99 → 09/05	1.299	B	M	4	16	2NZ-FE, 2SZ-FE		81809	
1.4 D-4D	55	12/01 → 09/05	1.364	D	M	4	8	1ND-TV		81809	
1.5 TS	77	01/03 → 09/05	1.497	B	M	4	16	1NZ-FE		81809	
1.5 VVT-i TS	78	04/01 → 09/05	1.497	B	M	4	16	1NZ-FE		81809	
	110	03/03 → 07/05	1.497	B	M	4	16	1NZ-FE		81809	

### Yaris II

1.0	52	08/07 →	998	B	M	3	12	1KR-FE		82063	
1.0 GPL	51	01/06 →	998		M	3	12	1KR-FE		82063	
1.0 VVT-i	51	08/05 →	998	B	M	3	12	1KR-FE		82063	
1.3	64	08/07 →	1.298	B	M	4	16	2NZ-FE, 2SZ-FE		81809	
1.3 4WD	64	08/07 →	1.298	B	M	4	16	2NZ-FE		81809	
1.3 VVT-i	64	08/05 →	1.298	B	M	4	16	2NZ-FE, 2SZ-FE	Flange: 4 holes	82048	
1.33 VVT-i	73	07/10 →	1.329	B	M	4	16	1NR-FE		84032	<b>NEW</b>
	74	03/09 →	1.329	B	M	4	16	1NR-FE		84032	<b>NEW</b>
1.4 D-4D	66	08/05 →	1.364	D	M	4	8	1ND-TV		81821	
1.5	80	08/07 →	1.497	B	M	4	16	1NZ-FE		81809	
	81	08/07 →	1.497	B	M	4	16	1NZ-FE		81809	
	80	11/05 →	1.497	B	M	4	16	1NZ-FE		81809	
1.8 VVTi	98	01/07 →	1.798	B	M	4	16	2ZR-FE		84030	<b>NEW</b>

### Yaris III

1.0	51	09/11 →	998	B	M	3	12	1KR-FE		82063	
1.3	70	09/11 →	1.329	B	M	4	16	1NR-FE		84032	<b>NEW</b>
	73	09/11 →	1.329	B	M	4	16	1NR-FE, 1NR-FKE		84032	<b>NEW</b>
1.3 4WD	70	12/10 →	1.329	B	M	4	16	1NR-FE		84032	<b>NEW</b>
1.3 VVT-i	63	12/10 →	1.299	B	M	4	16	2NZ-FE		81809	
1.4 D-4D	66	09/11 →	1.364	D	M	4	8	1ND-TV		84029	<b>NEW</b>

### Yaris Verso

1.3	62	11/02 → 09/05	1.299	B	M	4	16	2NZ-FE		81809	
	63	08/99 → 10/02	1.299	B	M	4	16	2NZ-FE		81809	
1.4 D-4D	55	12/01 → 09/05	1.364	D	M	4	8	1ND-TV		81809	
1.5	77	05/03 → 09/05	1.497	B	M	4	16	1NZ-FE		81809	
	78	03/00 → 09/05	1.497	B	M	4	16	1NZ-FE		81809	

**KW**

**cm<sup>3</sup>**

**NO. OF VALVES**

**MAGNETI MARELLI**
**VAUXHALL**
**AGILA**

1.3 CDTI	55	01/08 → 11/14	1.248	D	M	4	16	D13A, Z13DTJ		81862
----------	----	---------------	-------	---	---	---	----	--------------	--	-------

**ANTARA**

2.0 CDTI	110	08/06 → 04/15	1.991	D	M	4	16	Z20DMH		84014 <b>NEW</b>
----------	-----	---------------	-------	---	---	---	----	--------	--	------------------

**ASTRA**

1.3	55	09/85 → 08/91	1.297	B	M	4	8	13S		81543
-----	----	---------------	-------	---	---	---	---	-----	--	-------

1.3 CDTI	70	12/09 →	1.248	D	M	4	16	A13DTE		81862
----------	----	---------	-------	---	---	---	----	--------	--	-------

1.4	66	01/04 → 05/09	1.364	B	M	4	16	Z14XEP		82011
-----	----	---------------	-------	---	---	---	----	--------	--	-------

	64	12/09 →	1.398	B	M	4	16	A14XEL		84027 <b>NEW</b>
--	----	---------	-------	---	---	---	----	--------	--	------------------

	74	12/09 →	1.398	B	M	4	16	A14XER		84027 <b>NEW</b>
--	----	---------	-------	---	---	---	----	--------	--	------------------

	74	07/15 →	1.399	B	M	4	16	B14XE		84053 <b>NEW</b>
--	----	---------	-------	---	---	---	----	-------	--	------------------

1.4 16V	66	02/98 → 05/05	1.389	B	M	4	16	X14XE, Z14XE	09-2000 →	81817
---------	----	---------------	-------	---	---	---	----	--------------	-----------	-------

1.4 Turbo	103	12/09 →	1.364	B	M	4	16	A14NET		84027 <b>NEW</b>
-----------	-----	---------	-------	---	---	---	----	--------	--	------------------

1.6	62	09/00 → 05/05	1.598	B	M	4	8	Z16SE		81818
-----	----	---------------	-------	---	---	---	---	-------	--	-------

	85	12/09 →	1.598	B	M	4	16	A16XER, B16XER		82083
--	----	---------	-------	---	---	---	----	----------------	--	-------

1.6 16V	74	09/98 → 05/05	1.598	B	M	4	16	C16SEL, X16XEL, Z16XE, Z16XEP	05-2004 →, M: Z16XEP	82083
---------	----	---------------	-------	---	---	---	----	-------------------------------	----------------------	-------

	74	09/98 → 05/05	1.598	B	M	4	16	C16SEL, X16XEL, Z16XE, Z16XEP	09-2000 →	81817
--	----	---------------	-------	---	---	---	----	-------------------------------	-----------	-------

	74	02/98 → 05/05	1.598	B	M	4	16	X16XEL, Z16XE	09-2000 →	81817
--	----	---------------	-------	---	---	---	----	---------------	-----------	-------

	74	03/01 → 10/05	1.598	B	M	4	16	Z16XE	05-2004 →, M: Z16XEP	82083
--	----	---------------	-------	---	---	---	----	-------	----------------------	-------

	74	03/01 → 10/05	1.598	B	M	4	16	Z16XE		81817
--	----	---------------	-------	---	---	---	----	-------	--	-------

1.6 Turbo	132	12/09 →	1.598	B	M	4	16	A16LET		82083
-----------	-----	---------	-------	---	---	---	----	--------	--	-------

2.0 CDTi	118	12/09 →	1.956	D	M	4	16	A20DTH		81872
----------	-----	---------	-------	---	---	---	----	--------	--	-------

2.2 16V	108	03/01 → 05/05	2.198	B	M	4	16	Z22SE		81812
---------	-----	---------------	-------	---	---	---	----	-------	--	-------

**COMBO**

1.7 DI 16V	48	09/01 → 11/11	1.686	D	M	4	16	Y17DTL		81836
------------	----	---------------	-------	---	---	---	----	--------	--	-------

**CORSA**

1.0 12V	43	09/00 → 10/03	973	B	M	3	12	Z10XE		81749
---------	----	---------------	-----	---	---	---	----	-------	--	-------

1.0 i 12V	40	11/96 → 09/00	973	B	M	3	12	X10XE		81749
-----------	----	---------------	-----	---	---	---	----	-------	--	-------

1.2 16V	55	09/00 → 10/06	1.199	B	M	4	16	Z12XE	09-1996 →	81549
---------	----	---------------	-------	---	---	---	----	-------	-----------	-------

1.3 CDTI 16V	52	08/00 → 09/06	1.248	D	M	4	16	Z13DT		81862
--------------	----	---------------	-------	---	---	---	----	-------	--	-------

1.4 16V	66	09/00 → 10/06	1.389	B	M	4	16	Z14XE		81817
---------	----	---------------	-------	---	---	---	----	-------	--	-------

1.5 D	37	12/92 → 12/96	1.488	D	M	4	8	15D	→ M: 877.697	81685
-------	----	---------------	-------	---	---	---	---	-----	--------------	-------

	37	12/92 → 12/96	1.488	D	M	4	8	15D	M →: 877.698	81748
--	----	---------------	-------	---	---	---	---	-----	--------------	-------

1.5 TD	49	03/93 → 10/96	1.488	D	M	4	8	15DT (T4EC1), X15DT (T4EC1)	03-1993 →, → M: 877.697	81685
--------	----	---------------	-------	---	---	---	---	-----------------------------	-------------------------	-------

	49	03/93 → 10/96	1.488	D	M	4	8	15DT (T4EC1), X15DT (T4EC1)	03-1993 →, M →: 877.698	81748
--	----	---------------	-------	---	---	---	---	-----------------------------	-------------------------	-------

1.7 DI 16V	48	08/00 → 09/06	1.686	D	M	4	16	Y17DTL		81687
------------	----	---------------	-------	---	---	---	----	--------	--	-------

1.7 DTI 16V	55	08/00 → 09/06	1.686	D	M	4	16	Y17DT		81687
-------------	----	---------------	-------	---	---	---	----	-------	--	-------

**CORSAVAN**

1.3 CDTI 16V	52	04/04 → 06/06	1.248	D	M	4	16	Z13DT		81862
--------------	----	---------------	-------	---	---	---	----	-------	--	-------



		<b>KW</b>		<b>cm<sup>3</sup></b>				<b>NO. OF VALVES</b>		
--	--	-----------	--	-----------------------	--	--	--	----------------------	--	--

## VAUXHALL

### MERIVA

1.6 i	64	01/03 → 06/10	1.598	B	M	4	8	Z16SE		81818
1.6 i 16V	74	01/03 → 09/05	1.598	B	M	4	16	Z16XE		81817

### MOVANO

1.9 DTI	59	09/00 → 10/01	1.870	D	M	4	8	F9Q770		81814
	59	09/00 → 10/01	1.870	D	M	4	8	F9Q770		84009
	60	10/01 → 05/10	1.870	D	M	4	8	F9Q774		81814
	60	10/01 → 05/10	1.870	D	M	4	8	F9Q774		84009
2.2 DTI	66	09/00 → 05/10	2.188	D	M	4	16	G9T720, G9T722, G9T750		81855
	66	09/00 → 05/10	2.188	D	M	4	16	G9T720, G9T750		81855
2.5 D	59	10/98 → 01/01	2.499	D	M	4	8	S8U770		81834
2.8 DTI	84	10/98 → 10/01	2.799	D	M	4	8	S9W702		81835
	84	10/98 → 10/01	2.799	D	M	4	8	S9W702		81835

### OMEGA

2.0	85	09/95 → 09/96	1.998	B	M	4	8	Z0SE		81551
-----	----	---------------	-------	---	---	---	---	------	--	-------

### SIGNUM

2.2 i	114	05/03 → 05/08	2.198	B	M	4	16	Z22YH		81812
2.8 V6 Turbo	169	07/05 → 05/08	2.792	B	M	6	24	Z28NEL		84057 <b>NEW</b>

### TIGRA

1.3 CDTI	51	06/04 → 08/09	1.248	D	M	4	16	Z13DT		81862
----------	----	---------------	-------	---	---	---	----	-------	--	-------

### VECTRA

1.8 16V	90	04/02 → 07/08	1.796	B	M	4	16	Z18XE		81751
2.8 V6 Turbo	169	08/05 → 07/08	2.792	B	M	6	24	Z28NEL		84057 <b>NEW</b>
	184	08/06 → 07/08	2.792	B	M	6	24	Z28NET		84057 <b>NEW</b>
	188	08/05 → 07/08	2.792	B	M	6	24	Z28NET		84057 <b>NEW</b>

### VIVA

1.0	55	01/15 →	999	B	M	3	12	B10XE		84053 <b>NEW</b>
-----	----	---------	-----	---	---	---	----	-------	--	------------------

### VIVARO

1.9 DI	59	08/01 → 12/06	1.870	D	M	4	8	F9Q762		81814
	59	08/01 → 12/06	1.870	D	M	4	8	F9Q762		84009
1.9 DTI	74	08/01 → 12/06	1.870	D	M	4	8	F9Q760		81814
	74	08/01 → 12/06	1.870	D	M	4	8	F9Q760		84009

### ZAFIRA

1.6 16V	74	04/99 → 08/05	1.598	B	M	4	16	X16XEL, Z16XE	07-2000 →	81817
2.0 GSI Turbo	141	09/01 → 06/05	1.998	B	M	4	16	Z20LET		81747
2.2 16V	108	11/98 → 08/04	2.198	B	M	4	16	Z22SE		81812

## VOLKSWAGEN

### Amarok

2.0 BITDI	120	09/10 →	1.968	D	M	4	16	CDCA		84001
	132	11/11 →	1.968	D	M	4	16	CNEA, CSHA		84001
2.0 BITDI 4motion	120	09/10 →	1.968	D	M	4	16	CDCA		84001
	132	11/11 →	1.968	D	M	4	16	CNEA, CSHA		84001



KW



cm<sup>3</sup>



NO. OF VALVES



MAGNETI MARELLI

## VOLKSWAGEN

### Amarok

2.0 TDI	90	09/10 →	1.968	D	M	4	16	CDBA, CNFA		84001
	103	07/12 →	1.968	D	M	4	16	CNFB		84001
2.0 TDI 4motion	90	09/10 →	1.968	D	M	4	16	CDBA, CNFA		84001
	103	06/12 →	1.968	D	M	4	16	CNFB		84001
2.0 TSI	118	12/10 →	1.984	B	M	4	16	CFPA		84016 <b>NEW</b>

### Beetle II (Maggiolino)

1.2 TSI	77	07/11 →	1.197	B	M	4	8	CBZB		84045 <b>NEW</b>
1.6 TDI	77	10/11 →	1.598	D	M	4	16	CAYC		84001
2.0 TDI	103	04/11 →	1.968	D	M	4	16	CFFB, CJAA		84001
	103	04/12 →	1.968	D	M	4	16	CFFB, CJAA		81816
	103	04/12 →	1.968	D	M	4	16	CFFB, CJAA		84011 <b>NEW</b>
2.0 TSI 2.0 TSI	147	04/11 →	1.984	B	M	4	16	CBFA, CCTA, CCZA		84016 <b>NEW</b>
	155	12/12 →	1.984	B	M	4	16	CPLA, CPPA		84037 <b>NEW</b>
	162	12/14 →	1.984	B	M	4	16	CULC		84037 <b>NEW</b>

### Bora, Station Wagon

1.4 16V	55	03/00 → 05/05	1.390	B	M	4	16	AHW, AKQ, APE, AXP, BCA	04-1998 →	81777
	55	09/01 → 05/05	1.390	B	M	4	16	AHW, AXP, BCA		81777
1.6	74	10/98 → 05/05	1.595	B	M	4	8	AEH, AKL, APF		81702
	75	08/00 → 05/05	1.595	B	A	4	8	AVU, BFQ		81702
	75	08/00 → 05/05	1.595	B	A	4	8	AVU, BFQ, BJH		81702
	78	06/02 → 10/04	1.595	B	M	4	20	AWB		81702
1.6 16V	77	05/00 → 05/05	1.598	B	M	4	16	ATN, AUS, AZD, BCB		81840
1.6 FSI	81	01/02 → 05/05	1.598	B	M	4	16	BAD		81840
1.8	92	10/98 → 05/05	1.781	B	M	4	20	AGN, BAF		81703
1.8 4motion	92	02/99 → 05/05	1.781	B	M	4	20	AGN		81703
1.8 T	110	05/00 → 05/05	1.781	B	M	4	20	AGU, ARX, AUM		81703
	110	05/00 → 05/05	1.781	B	M	4	20	AGU, ARX, AUM, BAE		81703
	132	03/02 → 05/05	1.781	B	M	4	20	AUQ		81703
1.9 SDI	50	10/98 → 05/05	1.896	D	M	4	8	AGP, AQM		81706
1.9 TDI	66	10/98 → 05/05	1.896	D	M	4	8	AGR, ALH		81706
	74	09/00 → 05/05	1.896	D	M	4	8	ATD, AXR		81816
	74	09/00 → 05/05	1.896	D	M	4	8	ATD, AXR		84011 <b>NEW</b>
	81	10/98 → 06/01	1.896	D	M	4	8	AHF, ASV		81706
	85	12/98 → 01/02	1.896	D	M	4	8	AJM, AUY		81816
	85	12/98 → 01/02	1.896	D	M	4	8	AJM, AUY		84011 <b>NEW</b>
	96	11/00 → 05/05	1.896	D	M	4	8	ASZ		81816
	96	11/00 → 05/05	1.896	D	M	4	8	ASZ		84011 <b>NEW</b>
	110	05/00 → 05/05	1.896	D	M	4	8	ARL		81816
	110	05/00 → 05/05	1.896	D	M	4	8	ARL		84011 <b>NEW</b>

		KW		cm <sup>3</sup>				NO. OF VALVES		
--	--	----	--	-----------------	--	--	--	---------------	--	--

## VOLKSWAGEN

### Bora, Station Wagon

1.9 TDI 4motion	66	11/98 → 04/02	1.896	D	M	4	8	AGR		81706
	74	09/00 → 05/05	1.896	D	M	4	8	ATD		81816
	74	09/00 → 05/05	1.896	D	M	4	8	ATD		84011 <b>NEW</b>
	85	02/99 → 06/01	1.896	D	M	4	8	AJM, AUJ		81816
	85	02/99 → 06/01	1.896	D	M	4	8	AJM, AUJ		84011 <b>NEW</b>
	96	11/00 → 05/05	1.896	D	M	4	8	ASZ		81816
	96	11/00 → 05/05	1.896	D	M	4	8	ASZ		84011 <b>NEW</b>
	110	05/00 → 05/05	1.896	D	M	4	8	ARL		81816
	110	05/00 → 05/05	1.896	D	M	4	8	ARL		84011 <b>NEW</b>
2.0	85	05/99 → 05/05	1.984	B	M	4	8	APK, AQY, AZG, AZH, AZJ		81703
	85	10/98 → 05/05	1.984	B	M	4	8	APK, AQY, AZG, AZH, AZJ, BBW		81703
2.0 4motion	85	04/00 → 05/05	1.984	B	M	4	8	AZH, AZJ		81703
2.3 V5	110	10/98 → 10/00	2.324	B	M	5	10	AGZ	08-1998 →	81856
	110	05/99 → 10/00	2.324	B	M	5	10	AGZ		81856
	125	10/00 → 05/05	2.324	B	M	5	20	AQN		81856
2.3 V5 4motion	110	12/98 → 10/00	2.324	B	M	5	10	AGZ	08-1998 →	81856
	110	05/99 → 10/00	2.324	B	M	5	10	AGZ		81856
	125	10/00 → 05/05	2.324	B	M	5	20	AQN		81856
2.8 V6 4motion	150	03/99 → 05/05	2.792	B	M	6	24	AQP, AUE, BDE	M: AUE, M: AQP	81773
	150	03/99 → 05/05	2.792	B	M	6	24	AQP, AUE, BDE	M: BDE	81866
<b>Caddy I</b>										
1.6	55	01/83 → 07/92	1.595	B	M	4	8	EW	(-)COP	81522
	55	01/83 → 07/92	1.595	B	M	4	8	EW	(+)COP	82080
1.6 D	40	08/82 → 07/92	1.588	D	M	4	8	JK, ME	(-)COP	81522
	40	08/82 → 07/92	1.588	D	M	4	8	JK, ME	(+)COP	82080
1.8	70	08/85 → 07/92	1.781	B	M	4	8	JH	(-)COP	81522
	70	08/85 → 07/92	1.781	B	M	4	8	JH	(+)COP	82080
<b>Caddy II</b>										
1.4	44	11/95 → 01/04	1.390	B	M	4	8	AEX, AKV, APQ, AUD		81527
	55	08/00 → 01/04	1.390	B	M	4	16	AUA		81777
1.4 16V	55	08/00 → 01/04	1.390	B	M	4	16	AUA		81777
1.6	55	11/95 → 05/97	1.595	B	M	4	8	1F	(-)COP	81522
	55	11/95 → 05/97	1.595	B	M	4	8	1F	(+)COP	82080
	55	06/96 → 12/00	1.598	B	M	4	8	AEE		81527
1.7 SDI	42	07/96 → 09/00	1.716	D	M	4	8	AHB	(-)COP	81522
	42	07/96 → 09/00	1.716	D	M	4	8	AHB	(+)COP	82080
1.9 D	47	11/95 → 01/04	1.896	D	M	4	8	1Y	(-)COP	81522
	47	11/95 → 01/04	1.896	D	M	4	8	1Y	(+)COP	82080
	47	06/96 → 12/00	1.896	D	M	4	8	AEF		81528

**KW**

**cm<sup>3</sup>**

**NO. OF VALVES**

**VOLKSWAGEN**
**Caddy II**

1.9 SDI	47	11/95 → 01/04	1.896	D	M	4	8	AEY, AYQ	(-)COP, M: AEY	81522
	47	11/95 → 01/04	1.896	D	M	4	8	AEY, AYQ	(+)COP	82080
	47	11/95 → 01/04	1.896	D	M	4	8	AEY, AYQ	(+)COP, M: AEY	82080
	47	11/95 → 01/04	1.896	D	M	4	8	AEY, AYQ	M: AYQ	81706
1.9 TDI	66	09/96 → 01/04	1.896	D	M	4	8	1Z, AHU, ALH	(-)COP	81522
	66	09/96 → 01/04	1.896	D	M	4	8	1Z, AHU, ALH	(+)COP	82080
	66	10/96 → 01/04	1.896	D	M	4	8	AHU, ALE, ALH	(-)COP	81522
	66	10/96 → 01/04	1.896	D	M	4	8	AHU, ALE, ALH	(+)COP	82080
60 1.4	44	11/95 → 01/04	1.390	B	M	4	8	AEX, APQ, AUD		81527
75 1.6	55	11/95 → 05/97	1.595	B	M	4	8	1F	(-)COP	81522
	55	11/95 → 05/97	1.595	B	M	4	8	1F	(+)COP	82080
	55	11/95 → 09/00	1.598	B	M	4	8	AEE		81527

**Caddy III**

1.2 TSI	63	09/10 →	1.197	B	M	4	8	CBZA		84045	<b>NEW</b>
	77	09/10 →	1.197	B	M	4	8	CBZB		84045	<b>NEW</b>
1.4	55	03/04 → 05/06	1.390	B	M	4	16	BCA		81777	
	59	05/06 → 08/10	1.390	B	M	4	16	BUD		81777	
1.6	74	03/05 →	1.595	B	M	4	8	BRY		81702	
	75	04/04 →	1.595	B	M	4	8	BGU, BSE, BSF		81702	
1.6 BiFuel	75	05/11 →	1.595	BF	M	4	8	CHGA		81702	
1.6 TDI	55	08/10 →	1.598	D	M	4	16	CAYE		84001	
	75	08/10 →	1.598	D	M	4	16	CAYD		84001	
1.9 TDI	55	09/05 → 08/10	1.896	D	M	4	8	BSU		84010	<b>NEW</b>
	55	09/05 → 08/10	1.896	D	M	4	8	BSU		81791	
	77	04/04 → 08/10	1.896	D	M	4	8	BJB, BLS		84010	<b>NEW</b>
	77	04/04 → 08/10	1.896	D	M	4	8	BJB, BLS		81791	
1.9 TDI 4motion	77	11/08 → 08/10	1.896	D	M	4	8	BLS		84010	<b>NEW</b>
	77	11/08 → 08/10	1.896	D	M	4	8	BLS		81791	
2.0 EcoFuel	80	04/06 →	1.984	M	M	4	8	BSX		81703	
2.0 SDI	51	03/04 → 08/10	1.968	D	M	4	8	BDJ, BST		84010	<b>NEW</b>
	51	03/04 → 08/10	1.968	D	M	4	8	BDJ, BST		81791	
2.0 TDI	62	11/10 →	1.968	D	M	4	16	CFHE		84001	
	81	08/10 →	1.968	D	M	4	16	CLCA		84001	
	103	09/07 → 08/10	1.968	D	M	4	8	BMM		81816	
	103	09/07 → 08/10	1.968	D	M	4	8	BMM		84011	<b>NEW</b>
	125	05/12 →	1.968	D	M	4	16	CFJA		84001	
2.0 TDI 16V	103	11/10 →	1.968	D	M	4	16	CFHC, CLCB		84001	
2.0 TDI 16V 4motion	103	11/10 →	1.968	D	M	4	16	CFHC		84001	
2.0 TDI 4motion	62	12/10 →	1.968	D	M	4	16	CFHE		84001	
	81	08/10 →	1.968	D	M	4	16	CFHF		84001	

**KW**

**cm<sup>3</sup>**

**NO. OF VALVES**

**VOLKSWAGEN**
**CC**

	112	11/11 →	1.798	B	M	4	16	CDAB		84016	<b>NEW</b>
	118	11/11 →	1.798	B	M	4	16	CDAА		84016	<b>NEW</b>
2.0 TDI	100	11/11 →	1.968	D	M	4	16	CFFA		84001	
	103	11/11 →	1.968	D	M	4	16	CFFB		84001	
	125	11/11 →	1.968	D	M	4	16	CFGБ, CLLA		84001	
	130	12/12 →	1.968	D	M	4	16	CFGС		84001	
2.0 TDI 4motion	103	11/11 →	1.968	D	M	4	16	CFFB		84001	
	125	11/11 →	1.968	D	M	4	16	CFGБ		84001	
	130	12/12 →	1.968	D	M	4	16	CFGС		84001	
2.0 TSI	155	11/11 →	1.984	B	M	4	16	CCZB		84016	<b>NEW</b>
3.6 FSI 4motion	220	11/11 →	3.597	B	M	6	24	BWS		81866	

**Corrado**

1.8 16V	100	04/89 → 07/92	1.781	B	M	4	16	KR	(-)COP	81522	
	100	04/89 → 07/92	1.781	B	M	4	16	KR	(+)COP	82080	
1.8 G60	118	09/88 → 09/93	1.781	B	M	4	8	PG	(-)COP	81522	
	118	09/88 → 09/93	1.781	B	M	4	8	PG	(+)COP	82080	
2.0 i	85	04/93 → 12/95	1.984	B	M	4	8	2E, ADY	(-)COP	81522	
	85	04/93 → 12/95	1.984	B	M	4	8	2E, ADY	(+)COP	82080	
2.0 i 16V	100	08/91 → 12/95	1.984	B	M	4	16	9A	(-)COP	81522	
	100	08/91 → 12/95	1.984	B	M	4	16	9A	(+)COP	82080	
2.9 VR6	140	08/91 → 12/95	2.861	B	M	6	12	ABV		81773	

**Crafter 30-35, 30-50**

2.0 TDI	80	05/11 →	1.968	D	M	4	16	CKTB		84001	
	100	05/11 →	1.968	D	M	4	16	CKTC		84001	
	105	10/11 →	1.968	D	M	4	16	CKUC		84001	
	120	07/11 →	1.968	D	M	4	16	CKUB, CSNA		84001	
2.0 TDI 4motion	120	11/11 →	1.968	D	M	4	16	CKUB, CSNA		84001	
2.5 TDI	65	04/06 → 07/11	2.461	D	M	5	10	BJJ, CEBA		84010	<b>NEW</b>
	65	04/06 → 07/11	2.461	D	M	5	10	BJJ, CEBA		81791	

**Eos**

1.4 TSI	118	05/08 →	1.390	B	M	4	16	CAVD, CTHD		82097	
1.6 FSI	85	06/06 → 05/08	1.598	B	M	4	16	BLF		81865	
2.0 FSI	110	03/06 → 05/08	1.984	B	M	4	16	BVY, BVZ		81702	
2.0 TDI	100	11/10 →	1.968	D	M	4	16	CFFA		84001	
	103	06/06 → 05/08	1.968	D	M	4	8	BMM		81816	
	103	06/06 → 05/08	1.968	D	M	4	8	BMM		84011	<b>NEW</b>
2.0 TDI 16V	103	05/08 →	1.968	D	M	4	16	CBAB, CFFB		81816	
	103	05/08 →	1.968	D	M	4	16	CBAB, CFFB		84011	<b>NEW</b>
2.0 TFSI	147	03/06 →	1.984	B	M	4	16	BPY, BWA, CAWB, CBFA, CCTA, CCZA		82025	
2.0 TSI	155	11/09 →	1.984	B	M	4	16	CCZB		84016	<b>NEW</b>
3.2 V6	184	06/06 → 05/09	3.189	B	M	6	24	BUB, CBRA		81866	
3.6 V6	191	05/09 → 11/10	3.597	B	M	6	24	CDVA		81866	

**KW**

**cm<sup>3</sup>**

**NO. OF VALVES**

**MAGNETI MARELLI**
**VOLKSWAGEN**
**Fox I**

1.2	40	04/05 →	1.198	B	M	3	6	BMD, CHFB		81867
	44	09/10 →	1.198	B	M	3	6	CHFA		81867
1.4	55	04/05 →	1.390	B	M	4	8	BKR		81527
1.4 TDI	51	04/05 →	1.422	D	M	3	6	BNM		84010 <b>NEW</b>
	51	04/05 →	1.422	D	M	3	6	BNM		81791
1.6	74	10/03 →	1.598	B	M	4	8	BAH, BJA, BLH, BPA, CCRA, CFZA		81527
1.6 Total Flex	74	10/03 →	1.598		M	4	8	BJA, BPA, CCRA		81527

**Golf I, Cabrio**

1.6	53	04/86 → 02/90	1.595	B	M	4	8	RE	(-)COP	81522
	53	04/86 → 02/90	1.595	B	M	4	8	RE	(+)COP	82080
	55	08/83 → 04/92	1.595	B	M	4	8	EW, HN	(-)COP	81522
	55	08/83 → 04/92	1.595	B	M	4	8	EW, HN	(+)COP	82080
1.8	66	08/83 → 09/92	1.781	B	M	4	8	EX	(-)COP	81522
	66	08/83 → 09/92	1.781	B	M	4	8	EX	(+)COP	82080
	70	08/83 → 04/93	1.781	B	M	4	8	JH	(-)COP	81522
	70	08/83 → 04/93	1.781	B	M	4	8	JH	(+)COP	82080
	72	08/89 → 03/93	1.781	B	M	4	8	2H	(-)COP	81522
	72	08/89 → 03/93	1.781	B	M	4	8	2H	(+)COP	82080

**Golf II**

1.0	37	08/85 → 10/91	1.043	B	M	4	8	HZ	→ M: 786.022	81520
	37	08/85 → 10/91	1.043	B	M	4	8	HZ	M → : 786.023	81524
1.3 Cat.	40	06/86 → 12/92	1.272	B	M	4	8	2G, MH, NZ	→ M: 262.739	81520
	40	06/86 → 12/92	1.272	B	M	4	8	2G, MH, NZ	M → : 262.740	81524
1.6	51	10/86 → 12/92	1.595	B	M	4	8	PN	(-)COP	81522
	51	10/86 → 12/92	1.595	B	M	4	8	PN	(+)COP	82080
	53	02/86 → 10/91	1.595	B	M	4	8	RF	(-)COP	81522
	53	02/86 → 10/91	1.595	B	M	4	8	RF	(+)COP	82080
	55	08/83 → 07/92	1.595	B	M	4	8	ABN, EZ, HM	(-)COP	81522
	55	08/83 → 07/92	1.595	B	M	4	8	ABN, EZ, HM	(+)COP	82080
1.6 D	37	08/83 → 10/91	1.588	D	M	4	8		(-)COP	81522
	37	08/83 → 10/91	1.588	D	M	4	8		(+)COP	82080
	40	08/83 → 10/91	1.588	D	M	4	8	JP, ME	(-)COP	81522
	40	08/83 → 10/91	1.588	D	M	4	8	JP, ME	(+)COP	82080
1.6 TD	51	08/83 → 10/91	1.588	D	M	4	8	JR, MF	(-)COP	81522
	51	08/83 → 10/91	1.588	D	M	4	8	JR, MF	(+)COP	82080
	59	04/89 → 10/91	1.588	D	M	4	8	RA, SB	(-)COP	81522
	59	04/89 → 10/91	1.588	D	M	4	8	RA, SB	(+)COP	82080
	44	08/89 → 10/91	1.589	D	M	4	8	1V	(-)COP	81522
	44	08/89 → 10/91	1.589	D	M	4	8	1V	(+)COP	82080
1.8	62	08/86 → 01/90	1.781	B	M	4	8	RH	(-)COP	81522
	62	08/86 → 01/90	1.781	B	M	4	8	RH	(+)COP	82080
	66	08/84 → 10/91	1.781	B	M	4	8	GU, GX, HV	(-)COP	81522
	66	08/84 → 10/91	1.781	B	M	4	8	GU, GX, HV	(+)COP	82080

--	--	--	--	--	--	--	--	--	--	--

## VOLKSWAGEN

### Golf II

1.8 GTI	82	08/83 → 10/91	1.781	B	M	4	8	DX, EV, GZ, PB	(-)COP	81522
	82	08/83 → 10/91	1.781	B	M	4	8	DX, EV, GZ, PB	(+)COP	82080
1.8 GTI 16V	95	02/86 → 10/91	1.781	B	M	4	16	PL	(-)COP	81522
	95	02/86 → 10/91	1.781	B	M	4	16	PL	(+)COP	82080
	102	02/86 → 06/90	1.781	B	M	4	16	KR	(-)COP	81522
	102	02/86 → 06/90	1.781	B	M	4	16	KR	(+)COP	82080
1.8 GTI Cat.	79	01/87 → 10/91	1.781	B	M	4	8	PF	(-)COP	81522
	79	01/87 → 10/91	1.781	B	M	4	8	PF	(+)COP	82080
1.8 GTI G60	118	04/90 → 07/91	1.781	B	M	4	8	PG	(-)COP	81522
	118	04/90 → 07/91	1.781	B	M	4	8	PG	(+)COP	82080
1.8 GTI G60 Syncro	118	08/88 → 12/91	1.781	B	M	4	8	1H, PG	(-)COP	81522
	118	08/88 → 12/91	1.781	B	M	4	8	1H, PG	(+)COP	82080
1.8 i Cat.	66	08/87 → 10/91	1.781	B	M	4	8	GX, RP	(-)COP	81522
	66	08/87 → 10/91	1.781	B	M	4	8	GX, RP	(+)COP	82080
1.8 i Syncro Cat.	66	08/87 → 10/91	1.781	B	M	4	8	RP	(-)COP	81522
	66	08/87 → 10/91	1.781	B	M	4	8	RP	(+)COP	82080
1.8 Syncro	66	02/86 → 07/91	1.781	B	M	4	8	GU, GX	(-)COP	81522
	66	02/86 → 07/91	1.781	B	M	4	8	GU, GX	(+)COP	82080
	72	08/88 → 07/91	1.781	B	M	4	8	1P	(-)COP	81522
	72	08/88 → 07/91	1.781	B	M	4	8	1P	(+)COP	82080
2.0	57	08/85 → 07/92	1.968	B	M	4	8		(-)COP	81522
	57	08/85 → 07/92	1.968	B	M	4	8		(+)COP	82080

### Golf III, Variant, Cabrio

1.3	40	08/91 → 07/92	1.272	B	M	4	8	2G		81524
1.4	40	07/93 → 04/99	1.390	B	M	4	8	ABD	→ 07-1995	81524
	40	07/93 → 04/99	1.390	B	M	4	8	ABD	08-1995 →	81527
	40	11/91 → 08/97	1.390	B	M	4	8	ABD, AEX	08-1995 →, M: AEX	81527
	40	11/91 → 08/97	1.390	B	M	4	8	ABD, AEX	11-1991 →, → 07-1995, M: ABD	81524
	44	10/91 → 08/97	1.390	B	M	4	8	ABD, AEX	→ 07-1995, M: ABD	81524
	44	10/91 → 08/97	1.390	B	M	4	8	ABD, AEX	08-1995 →, M: AEX	81527
	44	07/93 → 04/99	1.390	B	M	4	8	ABD, AEX, APQ	→ 07-1995	81524
	44	07/93 → 04/99	1.390	B	M	4	8	ABD, AEX, APQ	08-1995 →	81527
1.6	74	10/94 → 05/98	1.595	B	M	4	8	AEK, AFT, AKS	(-)COP, 05-1996 →	81522
	74	10/94 → 05/98	1.595	B	M	4	8	AEK, AFT, AKS	(+)COP, 05-1996 →	82080
	74	07/95 → 08/97	1.595	B	M	4	8	AEK, AFT, AKS	(-)COP	81522
	74	07/95 → 08/97	1.595	B	M	4	8	AEK, AFT, AKS	(+)COP	82080
	74	07/95 → 08/97	1.595	B	M	4	8	AEK, AFT, AKS	(+)COP, M: AEK - AFT	82080
	55	09/92 → 08/97	1.598	B	M	4	8	ABU, AEA, AEE	→ 07-1995, M: ABU	81524
	55	09/92 → 08/97	1.598	B	M	4	8	ABU, AEA, AEE	05-1996 →, M: AEE, M: AEA, M: AEE	81527

**KW**

**cm<sup>3</sup>**

**NO. OF VALVES**

**VOLKSWAGEN**
**Golf III, Variant, Cabrio**

1.8	55	11/91 → 08/97	1.781	B	M	4	8	AAM	(-)COP	81522
	55	11/91 → 08/97	1.781	B	M	4	8	AAM	(+)COP	82080
	55	07/93 → 04/99	1.781	B	M	4	8	AAM, ANN	(-)COP	81522
	55	07/93 → 04/99	1.781	B	M	4	8	AAM, ANN	(+)COP	82080
	66	11/91 → 08/97	1.781	B	M	4	8	ABS, ACC, ADZ	(-)COP	81522
	66	11/91 → 08/97	1.781	B	M	4	8	ABS, ACC, ADZ	(+)COP	82080
	66	07/93 → 05/98	1.781	B	M	4	8	ABS, ADZ	(-)COP	81522
	66	07/93 → 05/98	1.781	B	M	4	8	ABS, ADZ	(+)COP	82080
	66	07/93 → 04/99	1.781	B	M	4	8	ABS, ADZ, ANP	(-)COP	81522
	66	07/93 → 04/99	1.781	B	M	4	8	ABS, ADZ, ANP	(+)COP	82080
1.8 Syncro	66	10/94 → 04/99	1.781	B	M	4	8	ADZ	(-)COP	81522
	66	10/94 → 04/99	1.781	B	M	4	8	ADZ	(+)COP	82080
	66	01/93 → 08/97	1.781	B	M	4	8	ABS, ADZ	(-)COP	81522
	66	01/93 → 08/97	1.781	B	M	4	8	ABS, ADZ	(+)COP	82080
1.9 D	48	11/91 → 08/97	1.896	D	M	4	8	1Y	(-)COP, → 07-1995	81522
	48	11/91 → 08/97	1.896	D	M	4	8	1Y	(+)COP	82080
	48	11/91 → 08/97	1.896	D	M	4	8	1Y	(+)COP, → 07-1995	82080
	48	11/91 → 08/97	1.896	D	M	4	8	1Y	08-1995 →	81528
	48	07/93 → 04/99	1.896	D	M	4	8	1Y	08-1995 →, → 04-1996	81528
1.9 SDI	47	07/95 → 04/99	1.896	D	M	4	8	AEY		81528
	47	07/95 → 08/97	1.896	D	M	4	8	AEY	(-)COP	81522
	47	07/95 → 08/97	1.896	D	M	4	8	AEY	(+)COP	82080
1.9 TD	55	07/93 → 04/99	1.896	D	M	4	8	AAZ	(-)COP, → 07-1995	81522
	55	07/93 → 04/99	1.896	D	M	4	8	AAZ	(+)COP	82080
	55	07/93 → 04/99	1.896	D	M	4	8	AAZ	(+)COP, → 07-1995	82080
	55	07/93 → 04/99	1.896	D	M	4	8	AAZ	08-1995 →, → 12-1997	81528
1.9 TD,GTD	55	11/91 → 08/97	1.896	D	M	4	8	AAZ	(-)COP, → 07-1995	81522
	55	11/91 → 08/97	1.896	D	M	4	8	AAZ	(+)COP	82080
	55	11/91 → 08/97	1.896	D	M	4	8	AAZ	(+)COP, → 07-1995	82080
	55	11/91 → 08/97	1.896	D	M	4	8	AAZ	08-1995 →	81528
1.9 TDI	66	09/93 → 08/97	1.896	D	M	4	8	1Z, AHU, ALE	(-)COP, → 07-1995	81522
	66	09/93 → 08/97	1.896	D	M	4	8	1Z, AHU, ALE	(+)COP	82080
	66	09/93 → 08/97	1.896	D	M	4	8	1Z, AHU, ALE	(+)COP, → 07-1995	82080
	66	09/93 → 08/97	1.896	D	M	4	8	1Z, AHU, ALE	08-1995 →	81528
	66	03/94 → 04/99	1.896	D	M	4	8	1Z, AHU, ALE	07-1995 →, → 12-1997, M: AHU	81528
	66	08/95 → 05/98	1.896	D	M	4	8	1Z, AHU, ALE	(-)COP, M: 1Z	81522
	66	08/95 → 05/98	1.896	D	M	4	8	1Z, AHU, ALE	(+)COP, M: 1Z	82080
	66	08/95 → 05/98	1.896	D	M	4	8	1Z, AHU, ALE	M: AHU	81528
	81	04/96 → 08/97	1.896	D	M	4	8	AFN	(-)COP	81522
	81	04/96 → 08/97	1.896	D	M	4	8	AFN	(+)COP	82080



		KW		cm <sup>3</sup>				NO. OF VALVES		
--	--	----	--	-----------------	--	--	--	---------------	--	--

## VOLKSWAGEN

### Golf III, Variant, Cabrio

1.9 TDI Syncro	66	07/95 → 04/99	1.896	D	M	4	8	1Z, AHU, ALE	(-)COP, → 07-1995	81522
	66	07/95 → 04/99	1.896	D	M	4	8	1Z, AHU, ALE	(+)COP	82080
	66	07/95 → 04/99	1.896	D	M	4	8	1Z, AHU, ALE	(+)COP, → 07-1995	82080
	66	07/95 → 04/99	1.896	D	M	4	8	1Z, AHU, ALE	08-1995 →	81528
	66	08/95 → 08/97	1.896	D	M	4	8	1Z, AHU, ALE		81528
2.0	79	08/95 → 04/96	1.984	B	M	4	8	AEP	(+)COP	82080
	85	11/91 → 08/97	1.984	B	M	4	8	2E, ABA, ADY, AGG, AKR	(-)COP	81522
	85	11/91 → 08/97	1.984	B	M	4	8	2E, ABA, ADY, AGG, AKR	(+)COP	82080
	85	07/93 → 05/98	1.984	B	M	4	8	2E, ADY, AGG, AKR	(-)COP, 08-1991 →	81522
	85	07/93 → 05/98	1.984	B	M	4	8	2E, ADY, AGG, AKR	(+)COP	82080
	85	07/93 → 05/98	1.984	B	M	4	8	2E, ADY, AGG, AKR	(+)COP, 08-1991 →	82080
2.0 GTI 16V	110	08/92 → 08/97	1.984	B	M	4	16	ABF	(-)COP, 08-1991 →	81522
	110	08/92 → 08/97	1.984	B	M	4	16	ABF	(+)COP	82080
	110	08/92 → 08/97	1.984	B	M	4	16	ABF	(+)COP, 08-1991 →	82080
2.0 Syncro	85	08/95 → 04/99	1.984	B	M	4	8	AGG	(-)COP, 08-1991 →	81522
	85	08/95 → 04/99	1.984	B	M	4	8	AGG	(+)COP	82080
	85	08/95 → 04/99	1.984	B	M	4	8	AGG	(+)COP, 08-1991 →	82080
	85	08/95 → 08/97	1.984	B	M	4	8	AGG	(-)COP, 08-1991 →	81522
	85	08/95 → 08/97	1.984	B	M	4	8	AGG	(+)COP	82080
	85	08/95 → 08/97	1.984	B	M	4	8	AGG	(+)COP, 08-1991 →	82080
2.8 VR6	128	01/92 → 08/97	2.792	B	M	6	12	AAA		81773
2.9 VR6 Syncro	140	10/94 → 04/99	2.861	B	M	6	12	ABV	01-1993 →	81773
	140	10/94 → 08/97	2.861	B	M	6	12	ABV	01-1993 →	81773

### Golf IV, Variant, Cabrio

1.4 16V	55	08/97 → 06/05	1.390	B	M	4	16	AHW, AKQ, APE, AXP, BCA		81777
	55	05/99 → 06/06	1.390	B	M	4	16	AHW, AKQ, APE, AXP, BCA	01-1997 →	81777
1.6	74	08/97 → 05/04	1.595	B	M	4	8	AEH, AKL, APF		81702
	74	06/98 → 06/02	1.595	B	M	4	8	AFT, AKS	(-)COP, 05-1996 →	81522
	74	06/98 → 06/02	1.595	B	M	4	8	AFT, AKS	(+)COP	82080
	74	06/98 → 06/02	1.595	B	M	4	8	AFT, AKS	(+)COP, 05-1996 →	82080
	75	08/00 → 06/06	1.595	B	A	4	8	AVU, BFQ		81702
	75	08/00 → 06/05	1.595	B	A	4	8	AVU, BFQ, BJH		81702
	78	08/03 → 06/05	1.595	B	M	4	20	AWB		81840
	74	02/01 → 06/01	1.598	B	M	4	8	BAH		81702
1.6 16V	77	02/00 → 06/05	1.598	B	M	4	16	ATN, AUS, AZD, BCB		81840
1.6 FSI	81	01/02 → 06/05	1.598	B	M	4	16	BAD	→ 09-2003	81840

**KW**

**cm<sup>3</sup>**

**NO. OF VALVES**

**MAGNETI MARELLI**
**VOLKSWAGEN**
**Golf IV, Variant, Cabrio**

1.8	55	06/98 → 06/02	1.781	B	M	4	8	AAM, ANN	(-)COP, 11-1991 →	81522
	55	06/98 → 06/02	1.781	B	M	4	8	AAM, ANN	(+)COP	82080
	55	06/98 → 06/02	1.781	B	M	4	8	AAM, ANN	(+)COP, 11-1991 →	82080
	66	06/98 → 06/02	1.781	B	M	4	8	ADZ, ANP	(-)COP, 11-1991 →	81522
	66	06/98 → 06/02	1.781	B	M	4	8	ADZ, ANP	(+)COP	82080
	66	06/98 → 06/02	1.781	B	M	4	8	ADZ, ANP	(+)COP, 11-1991 →	82080
	92	08/97 → 06/05	1.781	B	M	4	20	AGN, BAF	10-1997 →	81703
1.8 4motion	92	05/98 → 06/05	1.781	B	M	4	20	AGN		81703
1.8 T	110	08/97 → 06/05	1.781	B	M	4	20	AGU, AQA, ARZ, AUM, AWD	10-1997 →	81703
	110	05/00 → 06/06	1.781	B	M	4	20	AGU, AQA, ARZ, AUM, AWD		81703
1.8 T GTI	132	08/01 → 06/05	1.781	B	M	4	20	AUQ		81703
1.9 SDI	50	08/97 → 06/05	1.896	D	M	4	8	AGP, AQM	M: AQM, M: AGP	81706
1.9 TDI	66	10/97 → 05/04	1.896	D	M	4	8	AGR, ALH	M: ALH, M: AGR	81706
	66	06/98 → 06/02	1.896	D	M	4	8	AHU, ALE	(-)COP	81522
	66	06/98 → 06/02	1.896	D	M	4	8	AHU, ALE	(+)COP	82080
	74	09/00 → 06/05	1.896	D	M	4	8	ATD, AXR		81816
	74	09/00 → 06/05	1.896	D	M	4	8	ATD, AXR		84011 <b>NEW</b>
	81	06/98 → 06/02	1.896	D	M	4	8	AFN, AVG	(-)COP	81522
	81	06/98 → 06/02	1.896	D	M	4	8	AFN, AVG	(+)COP	82080
	81	08/97 → 05/04	1.896	D	M	4	8	AHF, ASV	M: ASF, M: AHF	81706
	81	05/99 → 06/01	1.896	D	M	4	8	AHF, ASV	M: ASV, M: AHF	81706
	85	12/98 → 06/01	1.896	D	AM	4	8	AJM, AUY		81816
	85	12/98 → 06/01	1.896	D	AM	4	8	AJM, AUY		84011 <b>NEW</b>
	96	11/00 → 06/05	1.896	D	M	4	8	ASZ		81816
	96	11/00 → 06/05	1.896	D	M	4	8	ASZ		84011 <b>NEW</b>
	110	06/01 → 06/06	1.896	D	M	4	8	ARL		81816
	110	05/00 → 06/05	1.896	D	M	4	8	ARL	M: ARL	81816
	1.9 TDI 4motion	110	05/00 → 06/05	1.896	D	M	4	8	ARL	
66		07/98 → 04/02	1.896	D	M	4	8	AGR, ALH	M: ALH, M: AGR	81706
74		09/00 → 06/05	1.896	D	M	4	8	ATD		81816
74		09/00 → 06/05	1.896	D	M	4	8	ATD		84011 <b>NEW</b>
85		05/99 → 06/01	1.896	D	M	4	8	AJM		81816
85		05/99 → 06/01	1.896	D	M	4	8	AJM		84011 <b>NEW</b>
85		09/99 → 06/01	1.896	D	M	4	8	AJM, AUY		81816
85		09/99 → 06/01	1.896	D	M	4	8	AJM, AUY		84011 <b>NEW</b>
96		11/00 → 06/05	1.896	D	M	4	8	ASZ		81816
96		11/00 → 06/05	1.896	D	M	4	8	ASZ		84011 <b>NEW</b>
110	05/02 → 06/05	1.896	D	M	4	8	ARL		81816	
110	02/00 → 06/05	1.896	D	M	4	8	ARL	M: ARL	81816	
110	02/00 → 06/05	1.896	D	M	4	8	ARL		84011 <b>NEW</b>	

		KW		cm <sup>3</sup>				NO. OF VALVES		
--	--	----	--	-----------------	--	--	--	---------------	--	--

## VOLKSWAGEN

### Golf IV, Variant, Cabrio

2.0	85	06/98 → 06/02	1.984	B	M	4	8	AGG, AKR, ATU, AWF, AWG	(-)COP, 08-1991 →	81522
	85	06/98 → 06/02	1.984	B	M	4	8	AGG, AKR, ATU, AWF, AWG	(+)COP	82080
	85	06/98 → 06/02	1.984	B	M	4	8	AGG, AKR, ATU, AWF, AWG	(+)COP, 08-1991 →	82080
	85	07/98 → 05/04	1.984	B	M	4	8	APK, AQY, AZG, AZJ, BER		81703
	85	05/99 → 06/06	1.984	B	M	4	8	APK, AQY, AZJ		81703
2.0 4motion	85	10/00 → 06/05	1.984	B	M	4	8	AZH, AZJ		81703
	88	12/99 → 06/06	1.984	B	M	4	8	ATF		81703
2.0 Bi-Fuel	85	02/02 → 06/06	1.984		M	4	8	BEH		81703
2.3 V5	110	08/97 → 10/00	2.324	B	M	5	10	AGZ		81856
	125	10/00 → 06/05	2.324	B	M	5	20	AQN		81856
2.3 V5 4motion	110	12/98 → 10/00	2.324	B	M	5	10	AGZ		81856
	125	10/00 → 06/05	2.324	B	M	5	20	AQN		81856
2.8 V6 4motion	150	03/99 → 06/05	2.792	B	M	6	24	AQP, AUE, BDE		81773
3.2 R32 4motion	177	09/02 → 06/05	3.189	B	M	6	24	BFH, BML		81866

### Golf V, Plus, Variant

1.2 TSI	63	05/10 → 12/13	1.197	B	M	4	8	CBZA		84045	
	77	11/09 → 12/13	1.197	B	M	4	8	CBZB		84045	
1.4	59	06/07 → 07/09	1.390	B	M	4	16	BUD		81777	
1.4 16V	55	01/05 → 11/06	1.390	B	M	4	16	BCA		81777	
	59	05/06 → 11/08	1.390	B	M	4	16	BUD		81777	
	59	05/06 → 12/13	1.390	B	M	4	16	BUD, CGGA		81777	
1.4 FSI	66	10/03 → 07/06	1.390	B	M	4	16	BKG, BLN		81865	
	66	07/05 → 11/06	1.390	B	M	4	16	BLN		81865	
	90	06/07 → 12/13	1.390	B	M	4	16	CAXA		82097	
1.6	75	01/04 → 11/08	1.595	B	M	4	8	BGU, BSE, BSF		81702	
	75	06/07 → 07/09	1.595	B	M	4	8	BGU, BSE, BSF, CCSA		81702	
	75	05/05 → 12/13	1.595	B	M	4	8	BSE, BSF, CCSA, CMXA		81702	
1.6 BiFuel	75	05/09 → 12/13	1.595	BF	M	4	8	CHGA		81702	
1.6 FSI	85	10/03 → 07/08	1.598	B	M	4	16	BAG, BLF, BLP		81865	
	85	01/05 → 05/08	1.598	B	M	4	16	BLF		81865	
1.6 MultiFuel	75	10/07 → 11/08	1.595		M	4	8	CCSA		81702	
	75	11/07 → 12/13	1.595		M	4	8	CCSA, CMXA		81702	
1.6 TDI	66	02/09 → 12/13	1.598	D	M	4	16	CAYB		84001	
	77	03/09 → 12/13	1.598	D	M	4	16	CAYC		84001	
1.9 TDI	66	05/05 → 12/08	1.896	D	M	4	8	BRU, BXF, BXJ		84010	
	66	05/05 → 12/08	1.896	D	M	4	8	BRU, BXF, BXJ		81791	
	77	01/05 → 01/09	1.896	D	M	4	8	BKC, BLS, BXE		84010	
	77	01/05 → 01/09	1.896	D	M	4	8	BKC, BLS, BXE		81791	
	77	06/07 → 07/09	1.896	D	M	4	8	BLS, BXE		84010	
77	06/07 → 07/09	1.896	D	M	4	8	BLS, BXE		81791		

**KW**

**cm<sup>3</sup>**

**NO. OF VALVES**

**MAGNETI MARELLI**
**VOLKSWAGEN**
**Golf V, Plus, Variant**

1.9 TDI 4motion	77	08/04 → 11/08	1.896	D	M	4	8	BKC, BLS, BXE	84010	<b>NEW</b>
	77	08/04 → 11/08	1.896	D	M	4	8	BKC, BLS, BXE	81791	
	77	01/08 → 07/09	1.896	D	M	4	8	BLS	84010	<b>NEW</b>
	77	01/08 → 07/09	1.896	D	M	4	8	BLS	81791	
2.0	147	06/07 → 07/09	1.984	B	M	4	16	BWA, CAWB, CCTA	82025	
2.0 FSI	110	01/04 → 11/08	1.984	B	M	4	16	AXW, BLR, BLX, BLY, BVX, BVY, BVZ	81702	
	110	05/05 → 06/08	1.984	B	M	4	16	BLR, BLY, BVY, BVZ	81702	
2.0 FSI 4motion	110	08/04 → 11/08	1.984	B	M	4	16	BLX, BLY, BVX, BVY, BVZ	81702	
2.0 GTI	147	10/04 → 02/09	1.984	B	M	4	16	AXX, BPY, BWA, CAWB, CBFA, CCTA	82025	
	169	09/06 → 12/08	1.984	B	M	4	16	BYD	82025	
2.0 SDI	55	01/04 → 11/08	1.968	D	M	4	8	BDK	84010	<b>NEW</b>
	55	01/04 → 11/08	1.968	D	M	4	8	BDK	81791	
2.0 TDI	81	01/09 → 12/13	1.968	D	M	4	16	CBDC, CLCA	81816	
	81	01/09 → 12/13	1.968	D	M	4	16	CBDC, CLCA	84011	<b>NEW</b>
	96	05/05 → 05/07	1.968	D	M	4	16	BEE	81816	
	96	05/05 → 05/07	1.968	D	M	4	16	BEE	84011	<b>NEW</b>
	100	06/07 → 07/09	1.968	D	M	4	16	AZV	81816	
	100	06/07 → 07/09	1.968	D	M	4	16	AZV	84011	<b>NEW</b>
	100	10/03 → 11/08	1.968	D	M	4	16	AZV, CBDA	81816	
	100	10/03 → 11/08	1.968	D	M	4	16	AZV, CBDA	84011	<b>NEW</b>
	100	05/05 → 12/13	1.968	D	M	4	16	AZV, CBDA, CFHB	81816	
	100	05/05 → 12/13	1.968	D	M	4	16	AZV, CBDA, CFHB	84011	<b>NEW</b>
	103	12/05 → 05/11	1.968	D	M	4	8	BMM	81816	
	103	12/05 → 05/11	1.968	D	M	4	8	BMM	84011	<b>NEW</b>
	125	11/05 → 11/08	1.968	D	M	4	16	BMN	81816	
	125	11/05 → 11/08	1.968	D	M	4	16	BMN	84011	<b>NEW</b>
2.0 TDI 16V	103	10/03 → 11/08	1.968	D	M	4	16	BKD	81816	
	103	10/03 → 11/08	1.968	D	M	4	16	BKD	84011	<b>NEW</b>
	103	06/07 → 07/09	1.968	D	M	4	16	BKD, CBDB	81816	
	103	06/07 → 07/09	1.968	D	M	4	16	BKD, CBDB	84011	<b>NEW</b>
	103	01/05 → 12/13	1.968	D	M	4	16	BKD, CBDB, CFHC	81816	
	103	01/05 → 12/13	1.968	D	M	4	16	BKD, CBDB, CFHC	84011	<b>NEW</b>
2.0 TDI 16V 4motion	103	08/04 → 11/08	1.968	D	M	4	16	BKD	81816	
	103	08/04 → 11/08	1.968	D	M	4	16	BKD	84011	<b>NEW</b>
2.0 TDI 4motion	100	06/07 → 07/09	1.968	D	M	4	16	AZV	81816	
	100	06/07 → 07/09	1.968	D	M	4	16	AZV	84011	<b>NEW</b>
	103	08/04 → 11/08	1.968	D	M	4	8	BMM	81816	
	103	08/04 → 11/08	1.968	D	M	4	8	BMM	84011	<b>NEW</b>
3.2	184	09/05 → 11/08	3.189	B	M	6	24	BUB	81866	
3.2 R32 4motion	177	01/04 → 11/08	3.189	B	M	6	24	BJS	81866	
	184	11/05 → 11/08	3.189	B	M	6	24	BUB, CBRA	81866	

		KW		cm <sup>3</sup>				NO. OF VALVES		
--	--	----	--	-----------------	--	--	--	---------------	--	--

## VOLKSWAGEN

### Golf VI, Variant, Cabrio

1.2 TSI	63	05/10 → 11/12	1.197	B	M	4	8	CBZA		84045	
	77	11/08 → 11/12	1.197	B	M	4	8	CBZB		84045	
1.2 TSI 16V	77	11/13 →	1.197	B	M	4	16	CYVD		84062	
1.4	59	07/09 → 07/13	1.390	B	M	4	16	BUD, CGGA		81777	
	59	10/08 → 11/12	1.390	B	M	4	16	CGGA		81777	
1.4 TSI	90	10/08 → 11/12	1.390	B	M	4	16	CAXA		82097	
	92	11/13 →	1.395	B	M	4	16	CXSB, CZCA		84062	
	110	11/13 →	1.395	B	M	4	16	CHPB, CZDA		84062	
1.6	75	10/08 → 11/12	1.595	B	M	4	8	BSE, BSF, CCSA, CMXA		81702	
1.6 BiFuel	75	03/09 → 11/12	1.595	BF	M	4	8	CHGA		81702	
1.6 MultiFuel	75	10/08 → 11/12	1.595		M	4	8	CCSA, CMXA		81702	
	75	07/10 → 07/13	1.595		M	4	8	CMXA		81702	
1.6 TDI	66	02/09 → 11/12	1.598	D	M	4	16	CAYB		84001	
	77	02/09 → 11/12	1.598	D	M	4	16	CAYC		84001	
1.6 TDI 4motion	77	07/09 → 07/13	1.598	D	M	4	16	CAYC		84001	
1.8 TSI	118	06/09 → 01/11	1.798	B	M	4	16	CDAA		84016	
2.0 GTi	147	06/09 → 11/13	1.984	B	M	4	16	CBFA, CCTA, CCZA		82025	
	155	04/09 → 11/12	1.984	B	M	4	16	CCZB		84016	
	173	05/11 → 11/12	1.984	B	M	4	16	CDLG		82025	
2.0 R	195	01/13 →	1.984	B	M	4	16	CDLA		82025	
2.0 R 4motion	188	11/09 → 11/13	1.984	B	M	4	16	CDLC, CRZA		82025	
	195	11/09 → 05/11	1.984	B	M	4	16	CDLA		82025	
	199	11/09 → 11/12	1.984	B	M	4	16	CDLF		82025	
2.0 TDI	81	10/08 → 11/12	1.968	D	M	4	16	CBDC, CLCA		81816	
	81	10/08 → 11/12	1.968	D	M	4	16	CBDC, CLCA		84011	
	81	01/10 → 07/13	1.968	D	M	4	16	CLCA		84001	
	100	10/08 → 11/12	1.968	D	M	4	16	CBAA, CFFA	M: CBAA	81816	
	100	10/08 → 11/12	1.968	D	M	4	16	CBAA, CFFA	M: CFFA	84001	
	100	10/08 → 11/12	1.968	D	M	4	16	CBAA, CFFA		84001	
	100	10/08 → 11/12	1.968	D	M	4	16	CBAA, CFFA		84011	
	100	07/09 → 07/13	1.968	D	M	4	16	CBDA, CFHB		81816	
	100	07/09 → 07/13	1.968	D	M	4	16	CBDA, CFHB		84011	
	103	10/08 → 05/13	1.968	D	M	4	16	CBAB, CFFB, CJAA		81816	
	103	10/08 → 05/13	1.968	D	M	4	16	CBAB, CFFB, CJAA		84011	
	103	11/11 →	1.968	D	M	4	16	CFHC		84001	
	125	04/09 → 11/12	1.968	D	M	4	16	CBBB, CFGB		81816	
	125	04/09 → 11/12	1.968	D	M	4	16	CBBB, CFGB		84011	
2.0 TDI 16V	103	07/09 → 07/13	1.968	D	M	4	16	CBDB, CFHC, CJAA, CLCB		81816	
	103	07/09 → 07/13	1.968	D	M	4	16	CBDB, CFHC, CJAA, CLCB		84011	

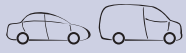
**KW**

**cm<sup>3</sup>**

**NO. OF VALVES**

**VOLKSWAGEN**
**Golf VI, Variant, Cabrio**

2.0 TDI 4motion	103	05/09 → 11/12	1.968	D	M	4	16	CBAB, CFFB	M: CBAB	81816
	103	05/09 → 11/12	1.968	D	M	4	16	CBAB, CFFB	M: CFFB	84001
	103	05/09 → 11/12	1.968	D	M	4	16	CBAB, CFFB		84001
	103	05/09 → 11/12	1.968	D	M	4	16	CBAB, CFFB		84011 <b>NEW</b>
2.0 TSI	147	07/09 → 07/13	1.984	B	M	4	16	CCZA		84016 <b>NEW</b>

**Golf VII, Variant, Cabrio, AllTrack**

1.0 TSI	85	05/15 →	999	B	M	3	12	CHZD		84062 <b>NEW</b>
1.2 TSI	63	08/12 →	1.197	B	M	4	16	CJZB, CYVA		84062 <b>NEW</b>
	63	05/14 →	1.197	B	M	4	16	CYVA		84062 <b>NEW</b>
	77	11/12 →	1.197	B	M	4	16	CJZA		84062 <b>NEW</b>
	81	04/14 →	1.197	B	M	4	16	CYVB		84062 <b>NEW</b>
1.4 GTE Hybrid	110	05/14 →	1.395		M	4	16	CUKB		84062 <b>NEW</b>
1.4 TGI CNG	81	06/13 →	1.395		M	4	16	CPWA, CZBA		84062 <b>NEW</b>
1.4 TSI	90	11/12 →	1.395	B	M	4	16	CMBA, CPVA, CXSA		84062 <b>NEW</b>
	90	05/13 →	1.395	B	M	4	16	CPVA, CXSA		84062 <b>NEW</b>
	92	04/14 →	1.395	B	M	4	16	CPVB, CZCA		84062 <b>NEW</b>
	103	05/13 →	1.395	B	M	4	16	CHPA		84062 <b>NEW</b>
	103	11/12 →	1.395	B	M	4	16	CHPA, CPTA		84062 <b>NEW</b>
	110	05/14 →	1.395	B	M	4	16	CHPB, CZDA		84062 <b>NEW</b>
	110	05/14 →	1.395	B	M	4	16	CHPB, CZDA, CZEA		84062 <b>NEW</b>
	110	02/14 →	1.395	B	M	4	16	CZDA		84062 <b>NEW</b>
1.4 TSI MultiFuel	90	04/13 →	1.395		M	4	16	CPVA		84062 <b>NEW</b>
	92	04/14 →	1.395		M	4	16	CPVB		84062 <b>NEW</b>
1.6	81	05/14 →	1.598	B	M	4	16	CWVA		84062 <b>NEW</b>
1.8 TSI 4motion	132	12/14 →	1.798	B	M	4	16	CJSB		84037 <b>NEW</b>
2.0 GTI	155	11/13 →	1.984	B	M	4	16	CNTA, CXCA		84037 <b>NEW</b>
	162	04/13 →	1.984	B	M	4	16	CHHB, CXDA		84037 <b>NEW</b>
	169	04/13 →	1.984	B	M	4	16	CHHA		84037 <b>NEW</b>
	195	02/16 →	1.984	B	M	4	16	CJXE		84037 <b>NEW</b>
2.0 R 4motion	206	11/13 →	1.984	B	M	4	16	CJXB		84037 <b>NEW</b>
	221	11/13 →	1.984	B	M	4	16	CJXC		84037 <b>NEW</b>

**Jetta II**

1.3 Cat.	40	06/87 → 12/91	1.272	B	M	4	8	2G, MH, NZ		81520
1.6	51	10/86 → 10/91	1.595	B	M	4	8	PN	(-)COP	81522
	51	10/86 → 10/91	1.595	B	M	4	8	PN	(+)COP	82080
	53	03/86 → 10/91	1.595	B	M	4	8	RF	(-)COP	81522
	53	03/86 → 10/91	1.595	B	M	4	8	RF	(+)COP	82080
	55	01/84 → 07/92	1.595	B	M	4	8	ABN, EZ, HM	(-)COP	81522
	55	01/84 → 07/92	1.595	B	M	4	8	ABN, EZ, HM	(+)COP	82080
1.6 D	40	01/84 → 10/91	1.588	D	M	4	8	JP, ME	(-)COP	81522
	40	01/84 → 10/91	1.588	D	M	4	8	JP, ME	(+)COP	82080

		KW		cm <sup>3</sup>				NO. OF VALVES		
--	--	----	--	-----------------	--	--	--	---------------	--	--

## VOLKSWAGEN

### Jetta II

1.6 TD	51	01/84 → 10/91	1.588	D	M	4	8	JR, MF	(-)COP	81522
	51	01/84 → 10/91	1.588	D	M	4	8	JR, MF	(+)COP	82080
	59	04/89 → 10/91	1.588	D	M	4	8	RA, SB	(-)COP	81522
	59	04/89 → 10/91	1.588	D	M	4	8	RA, SB	(+)COP	82080
	44	01/90 → 10/91	1.589	D	M	4	8	1V	(-)COP	81522
	44	01/90 → 10/91	1.589	D	M	4	8	1V	(+)COP	82080
1.8	62	08/86 → 01/90	1.781	B	M	4	8	RH	(-)COP	81522
	62	08/86 → 01/90	1.781	B	M	4	8	RH	(+)COP	82080
	66	08/84 → 10/91	1.781	B	M	4	8	GU, GX, HV	(-)COP	81522
	66	08/84 → 10/91	1.781	B	M	4	8	GU, GX, HV	(+)COP	82080
	82	01/84 → 10/91	1.781	B	M	4	8	EV, GZ, PB	(-)COP	81522
	82	01/84 → 10/91	1.781	B	M	4	8	EV, GZ, PB	(+)COP	82080
1.8 16V	95	08/86 → 10/91	1.781	B	M	4	16	PL	(-)COP	81522
	95	08/86 → 10/91	1.781	B	M	4	16	PL	(+)COP	82080
1.8 Cat.	66	08/87 → 10/91	1.781	B	M	4	8	GX, RP	(-)COP	81522
	66	08/87 → 10/91	1.781	B	M	4	8	GX, RP	(+)COP	82080
	79	01/87 → 10/91	1.781	B	M	4	8	PF	(-)COP	81522
	79	01/87 → 10/91	1.781	B	M	4	8	PF	(+)COP	82080
1.8 Syncro	72	08/88 → 07/91	1.781	B	M	4	8	1P	(-)COP	81522
	72	08/88 → 07/91	1.781	B	M	4	8	1P	(+)COP	82080

### Jetta III

1.4 TSI	90	05/07 → 10/10	1.390	B	M	4	16	CAXA		82097
1.6	75	10/05 → 10/10	1.595	B	M	4	8	BGU, BSE, BSF, CCSA		81702
1.6 FSI	85	09/05 → 10/10	1.598	B	M	4	16	BLF		81865
1.6 MultiFuel	75	01/08 → 10/10	1.595		M	4	8	CCSA		81702
1.6 TDI	66	12/09 → 10/10	1.598	D	M	4	16	CAYB		84001
	77	06/09 → 10/10	1.598	D	M	4	16	CAYC		84001
1.9 TDI	77	08/05 → 10/10	1.896	D	M	4	8	BKC, BLS, BXE		84010 <b>NEW</b>
	77	08/05 → 10/10	1.896	D	M	4	8	BKC, BLS, BXE		81791
2.0 FSI	110	08/05 → 10/10	1.984	B	M	4	16	BLR, BLX, BLY, BVY, BVZ		81702
2.0 TDI	100	09/05 → 10/10	1.968	D	M	4	16	AZV, CBDA		81816
	100	09/05 → 10/10	1.968	D	M	4	16	AZV, CBDA		84011 <b>NEW</b>
	103	10/05 → 10/10	1.968	D	M	4	8	BMM		81816
	103	10/05 → 10/10	1.968	D	M	4	8	BMM		84011 <b>NEW</b>
	125	10/06 → 10/10	1.968	D	M	4	16	BMN, CEGA		81816
	125	10/06 → 10/10	1.968	D	M	4	16	BMN, CEGA		84011 <b>NEW</b>
2.0 TDI 16V	103	08/05 → 10/10	1.968	D	M	4	16	BKD, CBDB, CBEA, CJAA		81816
	103	08/05 → 10/10	1.968	D	M	4	16	BKD, CBDB, CBEA, CJAA		84011 <b>NEW</b>
2.0 TFSI	147	10/05 → 10/10	1.984	B	M	4	16	AXX, BPY, BWA, CAWB, CBFA, CCTA, CCZA		82025

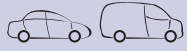
**KW**

**cm<sup>3</sup>**

**NO. OF VALVES**

**VOLKSWAGEN**
**Jetta IV**

1.2 TSI	77	02/11 →	1.197	B	M	4	8	CBZB		84045	<b>NEW</b>
1.4 TSI	90	05/11 →	1.390	B	M	4	16	CAXA, CMSB		82097	
1.6 TDI	77	02/11 →	1.598	D	M	4	16	CAYC		84001	
2.0 TDI	81	10/10 →	1.968	D	M	4	16	CLCA		84001	
	103	02/11 →	1.968	D	M	4	16	CFFB, CFHC, CJAA, CLCB		84001	
2.0 TSI	147	12/10 →	1.984	B	M	4	16	CBFA, CCTA, CCZA		84016	<b>NEW</b>
	155	12/12 →	1.984	B	M	4	16	CPLA, CPPA		84037	<b>NEW</b>

**LT I 28-35, 40-55**

2.4	66	12/82 → 07/92	2.383	B	M	6	12	DL		81833	
2.4 4WD	66	12/82 → 07/92	2.383	B	M	6	12	DL		81833	
2.4 D	51	08/89 → 06/96	2.383	D	M	6	12	1S, ACT		81593	
	55	01/79 → 07/92	2.383	D	M	6	12	CP, DW		81593	
2.4 i	69	08/89 → 06/96	2.383	B	M	6	12	1E		81833	
2.4 TD	68	08/89 → 08/92	2.383	D	M	6	12	1G		81593	
	70	09/92 → 06/96	2.383	D	M	6	12	ACL		81701	
	75	02/86 → 08/92	2.383	D	M	6	12	DV		81593	
2.4 TD 4WD	75	08/78 → 07/92	2.383	D	M	6	12	DV		81593	

**LT II 28-35, 28-46**

2.3	105	05/96 → 07/06	2.295	B	M	4	16	AGL		81774	
2.5 SDI	55	07/96 → 07/06	2.461	D	M	5	10	AGX		81701	
2.5 TDI	61	05/01 → 07/06	2.461	D	M	5	10	BBE		81701	
	66	05/99 → 07/06	2.461	D	M	5	10	APA		81701	
	70	05/01 → 07/06	2.461	D	M	5	10	BBF		81701	
	75	05/96 → 08/99	2.461	D	M	5	10	AHD		81701	
	80	05/99 → 07/06	2.461	D	M	5	10	ANJ, AVR		81701	

**Lupo I**

1.0	37	10/98 → 05/00	997	B	M	4	8	AHT		81807	
	37	09/98 → 07/05	999	B	M	4	8	AER, ALD, ALL, ANV, AUC	M: AHT	81807	
	37	09/98 → 07/05	999	B	M	4	8	AER, ALD, ALL, ANV, AUC	M: ALD, M: AUD, M: AUC, M: ALD, M: AER, M: AUC, M: ALL, M: AER, M: AUD, M: AUC, M: ANV, M: ALL, M: ALD, M: AER	81775	
1.2 TDI 3L	45	07/99 → 07/05	1.191	D	M	3	6	ANY, AYZ		84010	<b>NEW</b>
	45	07/99 → 07/05	1.191	D	M	3	6	ANY, AYZ		81791	
1.4	44	10/00 → 07/05	1.390	B	M	4	8	AUD		81775	
1.4 16V	55	09/98 → 07/05	1.390	B	M	4	16	AHW, AKQ, APE, AUA, BBY	11-1998 →	81777	
	74	08/99 → 07/05	1.390	B	M	4	16	AFK, AQQ, AUB		81777	
1.4 FSI	77	02/01 → 07/05	1.390	B	M	4	16	ARR		81777	



		KW		cm <sup>3</sup>				NO. OF VALVES		
--	--	----	--	-----------------	--	--	--	---------------	--	--

## VOLKSWAGEN

### Lupo I

1.4 TDI	55	01/99 → 07/05	1.422	D	M	3	6	AMF		84010	<b>NEW</b>
	55	01/99 → 07/05	1.422	D	M	3	6	AMF		81791	
1.6 GTI	92	09/00 → 07/05	1.598	B	M	4	16	AVY		81840	
1.7 SDI	44	09/98 → 07/05	1.716	D	M	4	8	AKU	11-1998 →	81528	

### Multivan V

1.9 TDI	62	01/06 → 11/09	1.896	D	M	4	8	BRR		84010	<b>NEW</b>
	62	01/06 → 11/09	1.896	D	M	4	8	BRR		81791	
	63	04/03 → 11/09	1.896	D	M	4	8	AXC		84010	<b>NEW</b>
	63	04/03 → 11/09	1.896	D	M	4	8	AXC		81791	
	75	06/06 → 11/09	1.896	D	M	4	8	BRS		84010	<b>NEW</b>
	75	06/06 → 11/09	1.896	D	M	4	8	BRS		81791	
	77	04/03 → 11/09	1.896	D	M	4	8	AXB		84010	<b>NEW</b>
	77	04/03 → 11/09	1.896	D	M	4	8	AXB		81791	
2.0	85	11/03 →	1.984	B	M	4	8	AXA		81703	
2.0 BiTDI	132	09/09 →	1.968	D	M	4	16	CFCA		84001	
2.0 BiTDI 4motion	132	09/09 →	1.968	D	M	4	16	CFCA		84001	
2.0 TDI	62	09/09 →	1.968	D	M	4	16	CAAA		84001	
	75	09/09 →	1.968	D	M	4	16	CAAB		84001	
	84	05/11 →	1.968	D	M	4	16	CAAD		84001	
	100	05/10 →	1.968	D	M	4	16	CAAE, CCHB		84001	
	103	09/09 →	1.968	D	M	4	16	CAAC, CCHA		84001	
2.0 TDI 4motion	100	05/10 →	1.968	D	M	4	16	CAAE, CCHB		84001	
	103	09/09 →	1.968	D	M	4	16	CAAC, CCHA		84001	
2.0 TSI	110	07/12 →	1.984	B	M	4	16	CJKB		84016	<b>NEW</b>
	150	05/11 →	1.984	B	M	4	16	CJKA		84016	<b>NEW</b>
2.0 TSI 4motion	150	07/11 →	1.984	B	M	4	16	CJKA		84016	<b>NEW</b>
2.5 TDI	96	04/03 → 11/09	2.461	D	M	5	10	AXD, BNZ		82033	
	120	11/03 → 11/09	2.461	D	M	5	10	BLJ		82033	
	128	04/03 → 11/09	2.461	D	M	5	10	AXE, BPC		82033	
2.5 TDI 4motion	96	07/04 → 11/09	2.461	D	M	5	10	AXD, BNZ		82033	
	128	07/04 → 11/09	2.461	D	M	5	10	AXE, BPC		82033	
3.2 V6	170	02/04 → 06/04	3.189	B	M	6	24	BDL		81866	
	173	02/04 → 11/09	3.189	B	M	6	24	BKK, CFLA		81866	
3.2 V6 4motion	173	07/04 → 11/09	3.189	B	M	6	24	BKK, CFLA		81866	

### New Beetle, Cabrio

1.4	55	11/01 → 09/10	1.390	B	M	4	16	BCA		81777	
1.6	74	10/99 → 09/00	1.595	B	M	4	8	AWH		81702	
	75	06/00 → 09/10	1.595	B	M	4	8	AYD, BFS		81702	
	75	01/03 → 09/10	1.595	B	M	4	8	BFS		81702	
1.8 T	110	10/99 → 09/10	1.781	B	M	4	20	AGU, APH, AVC, AWU, AWW, BKF		81703	
	110	01/03 → 09/10	1.781	B	M	4	20	AWU, AWW, BKF		81703	
	132	11/01 → 06/05	1.781	B	M	4	20	AWP, BNU		81703	

**KW**

**cm<sup>3</sup>**

**NO. OF VALVES**

**MAGNETI MARELLI**
**VOLKSWAGEN**
**New Beetle, Cabrio**

1.9 TDI	66	01/98 → 06/04	1.896	D	M	4	8	ALH		81706	
	74	02/01 → 09/10	1.896	D	M	4	8	ATD, BEW		84010	<b>NEW</b>
	74	02/01 → 09/10	1.896	D	M	4	8	ATD, BEW		81791	
	74	06/03 → 09/10	1.896	D	M	4	8	AXR		81816	
	74	06/03 → 09/10	1.896	D	M	4	8	AXR		84011	<b>NEW</b>
	77	07/05 → 09/10	1.896	D	M	4	8	BSW		84010	<b>NEW</b>
	77	07/05 → 09/10	1.896	D	M	4	8	BSW		81791	
	77	07/05 → 09/10	1.896	D	M	4	8	BSW		81816	
	77	07/05 → 09/10	1.896	D	M	4	8	BSW		84011	<b>NEW</b>
2.0	85	01/98 → 09/10	1.984	B	M	4	8	AEG, APK, AQY, AVH, AZG, AZJ, BEJ, BER, BEV, BHP, CBPA		81703	
	85	09/02 → 10/10	1.984	B	A	4	8	AQY, AZJ, BDC, BEV, BGD		81703	
2.3 V5	125	10/00 → 09/10	2.324	B	M	5	20	AQN		81856	
RSI 3.2 4motion	165	04/00 → 05/01	3.188	B	M	6	24	AXJ		81866	

**Passat III, Variant**

1.6	53	02/88 → 09/91	1.595	B	M	4	8	1F, EZ	(-)COP	81522	
	53	02/88 → 09/91	1.595	B	M	4	8	1F, EZ	(+)COP	82080	
	74	10/94 → 08/96	1.595	B	M	4	8	AEK, AFT	(-)COP	81522	
	74	10/94 → 08/96	1.595	B	M	4	8	AEK, AFT	(+)COP	82080	
1.6 TD	59	08/88 → 09/93	1.588	D	M	4	8	RA, SB	(-)COP	81522	
	59	08/88 → 09/93	1.588	D	M	4	8	RA, SB	(+)COP	82080	
1.8	55	08/90 → 08/96	1.781	B	M	4	8	AAM	(-)COP	81522	
	55	08/90 → 08/96	1.781	B	M	4	8	AAM	(+)COP	82080	
	66	02/88 → 08/96	1.781	B	M	4	8	ABS, ADZ, RP	(-)COP	81522	
	66	02/88 → 08/96	1.781	B	M	4	8	ABS, ADZ, RP	(+)COP	82080	
	79	04/88 → 07/93	1.781	B	M	4	8	PF	(-)COP	81522	
	79	04/88 → 07/93	1.781	B	M	4	8	PF	(+)COP	82080	
	82	04/88 → 07/92	1.781	B	M	4	8	PB	(-)COP	81522	
	82	04/88 → 07/92	1.781	B	M	4	8	PB	(+)COP	82080	
	102	08/91 → 09/93	1.781	B	M	4	16	KR	(-)COP	81522	
	102	08/91 → 09/93	1.781	B	M	4	16	KR	(+)COP	82080	
1.8 G60 Syncro	118	08/88 → 08/96	1.781	B	M	4	8	PG	(-)COP	81522	
	118	08/88 → 08/96	1.781	B	M	4	8	PG	(+)COP	82080	
1.8 GL	102	08/91 → 09/93	1.781	B	M	4	16	KR	(-)COP	81522	
	102	08/91 → 09/93	1.781	B	M	4	16	KR	(+)COP	82080	
1.9 D	50	05/89 → 10/93	1.896	D	M	4	8	1Y	(-)COP	81522	
	50	05/89 → 10/93	1.896	D	M	4	8	1Y	(+)COP	82080	
1.9 TD	55	03/91 → 08/96	1.896	D	M	4	8	AAZ	(-)COP	81522	
	55	03/91 → 08/96	1.896	D	M	4	8	AAZ	(+)COP	82080	

		KW		cm <sup>3</sup>				NO. OF VALVES		
--	--	----	--	-----------------	--	--	--	---------------	--	--

## VOLKSWAGEN

### Passat III, Variant

1.9 TDI	66	10/93 → 08/96	1.896	D	M	4	8	1Z, AHU	(-)COP	81522
	66	10/93 → 08/96	1.896	D	M	4	8	1Z, AHU	(+)COP	82080
	81	03/96 → 08/96	1.896	D	M	4	8	AFN	(-)COP	81522
	81	03/96 → 08/96	1.896	D	M	4	8	AFN	(+)COP	82080
2.0	79	03/95 → 08/96	1.984	B	M	4	8	AEP	(-)COP	81522
	79	03/95 → 08/96	1.984	B	M	4	8	AEP	(+)COP	82080
	85	02/90 → 10/96	1.984	B	M	4	8	2E, ABA, ADY, AGG	(-)COP	81522
	85	02/90 → 10/96	1.984	B	M	4	8	2E, ABA, ADY, AGG	(+)COP	82080
	85	02/90 → 05/97	1.984	B	M	4	8	2E, ADY, AGG	(-)COP	81522
	85	02/90 → 05/97	1.984	B	M	4	8	2E, ADY, AGG	(+)COP	82080
	125	04/88 → 07/91	1.984	B	M	4	8		(-)COP	81522
	125	04/88 → 07/91	1.984	B	M	4	8		(+)COP	82080
2.0 16V	100	08/88 → 09/93	1.984	B	M	4	16	9A	(-)COP	81522
	100	08/88 → 09/93	1.984	B	M	4	16	9A	(+)COP	82080
	110	01/94 → 08/96	1.984	B	M	4	16	ABF	(-)COP	81522
	110	01/94 → 08/96	1.984	B	M	4	16	ABF	(+)COP	82080
2.0 Syncro	81	09/89 → 07/92	1.984	B	M	4	8		(-)COP	81522
	81	09/89 → 07/92	1.984	B	M	4	8		(+)COP	82080
	85	10/90 → 08/96	1.984	B	M	4	8	2E, ADY, AGG	(-)COP	81522
	85	10/90 → 08/96	1.984	B	M	4	8	2E, ADY, AGG	(+)COP	82080
2.8 VR6	128	06/91 → 08/96	2.792	B	M	6	12	AAA		81773
2.9 VR6 Syncro	135	01/94 → 05/97	2.861	B	M	6	12	ABV		81773

### Passat IV, Variant

1.6	74	10/96 → 11/00	1.595	B	M	4	8	ADP, AHL, ANA, ARM	(-)COP, → 12-1997, M: ADP	81526
	74	10/96 → 11/00	1.595	B	M	4	8	ADP, AHL, ANA, ARM	(+)COP, → 12-1997, M: ADP	81529
	74	10/96 → 11/00	1.595	B	M	4	8	ADP, AHL, ANA, ARM	01-1998 →, M: ARM, M: ANA, M: ARM, M: AHL, M: ANA	81702
	74	06/97 → 11/00	1.595	B	M	4	8	ADP, AHL, ANA, ARM	01-1998 →, M: AHL, M: ANA, M: AHL, M: ARM, M: ANA	81702
1.8	85	01/97 → 11/00	1.781	B	M	4	20	AFY	(-)COP	81526
	85	01/97 → 11/00	1.781	B	M	4	20	AFY	(+)COP	81529
	92	10/96 → 11/00	1.781	B	M	4	20	ADR, APT, ARG	(-)COP	81526
	92	10/96 → 11/00	1.781	B	M	4	20	ADR, APT, ARG	(+)COP	81529
1.8 Syncro/4motion	92	10/96 → 11/00	1.781	B	M	4	20	ADR, APT, ARG	(-)COP	81526
	92	10/96 → 11/00	1.781	B	M	4	20	ADR, APT, ARG	(+)COP	81529
1.8 T	110	10/96 → 11/00	1.781	B	M	4	20	AEB, ANB, APU	(-)COP, M: ANB, M: AEB, M: ANB	81526
	110	10/96 → 11/00	1.781	B	M	4	20	AEB, ANB, APU	(+)COP, M: ANB, M: AEB, M: ANB	81529
	110	10/96 → 11/00	1.781	B	M	4	20	AEB, ANB, APU	M: APU	81702

**KW**

**cm<sup>3</sup>**

**NO. OF VALVES**

**MAGNETI MARELLI**
**VOLKSWAGEN**
**Passat IV, Variant**

1.8 T Syncro	110	11/96 → 08/00	1.781	B	M	4	20	AEB	(-)COP	81526
	110	11/96 → 08/00	1.781	B	M	4	20	AEB	(+)COP	81529
1.9 TDI	66	10/96 → 11/00	1.896	D	M	4	8	AHH, AHU		81528
	74	02/00 → 11/00	1.896	D	M	4	8	AVB		81816
	74	02/00 → 11/00	1.896	D	M	4	8	AVB		84011 <b>NEW</b>
	81	10/96 → 11/00	1.896	D	M	4	8	AFN, AVG		81528
	85	08/98 → 11/00	1.896	D	M	4	8	AJM, ATJ		81816
	85	08/98 → 11/00	1.896	D	M	4	8	AJM, ATJ		84011 <b>NEW</b>
1.9 TDI 4motion	85	08/99 → 11/00	1.896	D	M	4	8	ATJ		81816
	85	08/99 → 11/00	1.896	D	M	4	8	ATJ		84011 <b>NEW</b>
1.9 TDI Syncro/4motion	81	10/96 → 11/00	1.896	D	M	4	8	AFN, AVG		81528
2.0	88	04/00 → 11/00	1.984	B	M	4	8	ASU, AUZ		81703
2.0 4motion	88	04/00 → 11/00	1.984	B	M	4	8	ASU		81703
	88	04/00 → 11/00	1.984	B	M	4	8	ASU, AUZ		81703
2.3 VR5	110	10/96 → 11/00	2.324	B	M	5	10	AGZ		81856
2.3 VR5 Syncro/4motion	110	10/97 → 11/00	2.324	B	M	5	10	AGZ		81856
2.5 TDI	110	07/98 → 11/00	2.496	D	M	6	24	AFB, AKN		81705
2.5 TDI Syncro/4motion	110	12/98 → 11/00	2.496	D	M	6	24	AFB, AKN		81705
2.8 Syncro	132	05/97 → 09/99	2.771	B	M	6	30	AGE		81842
2.8 V6	132	05/97 → 09/99	2.771	B	M	6	30	AGE		81842
	140	09/99 → 11/00	2.771	B	M	6	30	ATX, BBG		81842
	142	08/96 → 11/00	2.771	B	M	6	30	ACK, AHA, APR, AQD		81842
2.8 V6 Syncro/4motion	142	10/96 → 11/00	2.771	B	M	6	30	ACK, AHA, ALG, APR, AQD		81842

**Passat V, Variant**

1.6	75	11/00 → 05/05	1.595	B	AM	4	8	ALZ		81702
1.8	92	03/03 → 03/05	1.781	B	M	4	20	APT	(-)COP	81526
	92	03/03 → 03/05	1.781	B	M	4	20	APT	(+)COP	81529
1.8 T	125	02/01 → 05/05	1.781	B	M	4	20	AWM		81703
1.8 T 20V	110	11/00 → 05/05	1.781	B	M	4	20	AWL, AWT		81703
	110	11/00 → 05/05	1.781	B	M	4	20	AWT		81703
1.8 T 4motion	125	03/01 → 05/05	1.781	B	M	4	20	AWM		81703
1.9 TDI	74	11/00 → 05/05	1.896	D	M	4	8	AVB		81816
	74	11/00 → 05/05	1.896	D	M	4	8	AVB		84011 <b>NEW</b>
	96	11/00 → 05/05	1.896	D	AM	4	8	AVF, AWX		81816
	96	11/00 → 05/05	1.896	D	AM	4	8	AVF, AWX		84011 <b>NEW</b>
	96	11/00 → 05/05	1.896	D	M	4	8	AVF, AWX		81816
	96	11/00 → 05/05	1.896	D	M	4	8	AVF, AWX		84011 <b>NEW</b>

**KW**

**cm<sup>3</sup>**

**NO. OF VALVES**

**MAGNETI MARELLI**
**VOLKSWAGEN**
**Passat V, Variant**

1.9 TDI 4motion	96	11/00 → 05/05	1.896	D	AM	4	8	AVF		81816
	96	11/00 → 05/05	1.896	D	AM	4	8	AVF		84011 <b>NEW</b>
	96	11/00 → 05/05	1.896	D	M	4	8	AVF		81816
	96	11/00 → 05/05	1.896	D	M	4	8	AVF		84011 <b>NEW</b>
2.0	85	11/00 → 05/05	1.984	B	M	4	8	AZM		81703
	85	11/00 → 05/05	1.984	B	M	4	8	AZM, BFF		81703
	96	11/01 → 05/05	1.984	B	M	4	20	ALT		81702
2.0 4motion	85	11/00 → 05/05	1.984	B	M	4	8	AZM		81703
2.0 TDI	100	12/03 → 05/05	1.968	D	M	4	8	BGW, BHW		81816
	100	12/03 → 05/05	1.968	D	M	4	8	BGW, BHW		84011 <b>NEW</b>
2.3 V5	125	11/00 → 05/05	2.324	B	M	5	20	AZX		81856
2.3 V5 4motion	125	11/00 → 05/05	2.324	B	M	5	20	AZX		81856
2.3 VR5	125	11/00 → 05/05	2.324	B	M	5	20	AZX		81856
2.3 VR5 4motion	125	11/00 → 05/05	2.324	B	M	5	20	AZX		81856
2.5 TDI	110	11/00 → 05/05	2.496	D	M	6	24	AFB, AKN		81705
	120	05/03 → 05/05	2.496	D	M	6	24	BDG		81705
2.5 TDI 4motion	110	11/00 → 05/05	2.496	D	M	6	24	AFB, AKN		81705
	132	01/03 → 05/05	2.496	D	M	6	24	BAU, BDH		81705
2.8 4motion	142	11/00 → 05/05	2.771	B	M	6	30	AMX, ATQ		81842

**Passat VI, Variant, CC**

1.4 TSI	90	05/07 → 07/10	1.390	B	M	4	16	CAXA		82097
1.6	75	05/05 → 07/10	1.595	B	M	4	8	BSE, BSF		81702
1.6 FSI	85	03/05 → 06/08	1.598	B	M	4	16	BLF		81865
1.6 TDI	77	08/09 → 07/10	1.598	D	M	4	16	CAYC		84001
1.8 TSI	112	11/09 → 07/10	1.798	B	M	4	16	CDAB, CGYA		84016 <b>NEW</b>
	118	05/07 → 07/10	1.798	B	M	4	16	BZB, CDA		84016 <b>NEW</b>
1.9 TDI	77	03/05 → 11/08	1.896	D	M	4	8	BKC, BLS, BXE		84010 <b>NEW</b>
	77	03/05 → 11/08	1.896	D	M	4	8	BKC, BLS, BXE		81791
2.0 BlueTDI	105	01/09 → 11/10	1.968	D	M	4	16	CBAC		81816
	105	01/09 → 11/10	1.968	D	M	4	16	CBAC		84011 <b>NEW</b>
2.0 FSI	110	03/05 → 07/10	1.984	B	M	4	16	BLR, BLY, BVY, BVZ		81702
	125	08/07 → 07/10	1.984	B	M	4	16	CCTB		84016 <b>NEW</b>
	147	07/05 → 07/10	1.984	B	M	4	16	AXX, BPY, BWA, CAWB, CBFA, CCTA, CCZA		82025
2.0 FSI 4motion	110	09/05 → 07/10	1.984	B	M	4	16	BLX, BLY, BVX		81702

**KW**

**cm<sup>3</sup>**

**NO. OF VALVES**

**VOLKSWAGEN**
**Passat VI, Variant, CC**

2.0 TDI	81	11/08 → 07/10	1.968	D	M	4	16	CBDC		81816	
	81	11/08 → 07/10	1.968	D	M	4	16	CBDC		84011	<b>NEW</b>
	88	11/05 → 05/07	1.968	D	M	4	16	BWV		81816	
	88	11/05 → 05/07	1.968	D	M	4	16	BWV		84011	<b>NEW</b>
	90	08/05 → 07/06	1.968	D	M	4	16	BVE		81816	
	90	08/05 → 07/06	1.968	D	M	4	16	BVE		84011	<b>NEW</b>
	100	03/05 → 11/10	1.968	D	M	4	16	BMA, CBAA		81816	
	100	03/05 → 11/10	1.968	D	M	4	16	BMA, CBAA		84011	<b>NEW</b>
	100	06/08 → 05/11	1.968	D	M	4	16	CBAA, CFFA		81816	
	100	06/08 → 05/11	1.968	D	M	4	16	CBAA, CFFA		84011	<b>NEW</b>
	103	03/05 → 05/09	1.968	D	M	4	8	BMP		81816	
	103	03/05 → 05/09	1.968	D	M	4	8	BMP		84011	<b>NEW</b>
	103	06/08 → 01/12	1.968	D	M	4	16	CBAB, CFFB		81816	
	103	06/08 → 01/12	1.968	D	M	4	16	CBAB, CFFB		84011	<b>NEW</b>
	120	08/05 → 05/09	1.968	D	M	4	16	BUZ		81816	
	120	08/05 → 05/09	1.968	D	M	4	16	BUZ		84011	<b>NEW</b>
	120	05/08 → 05/11	1.968	D	M	4	16	CBBA		84001	
	125	08/05 → 07/10	1.968	D	M	4	16	BMR, CBBB		81816	
	125	08/05 → 07/10	1.968	D	M	4	16	BMR, CBBB		84011	<b>NEW</b>
	125	06/08 → 01/12	1.968	D	M	4	16	CBBB, CFGB, CLLA		81816	
125	06/08 → 01/12	1.968	D	M	4	16	CBBB, CFGB, CLLA		84011	<b>NEW</b>	
2.0 TDI 16V	103	03/05 → 07/10	1.968	D	M	4	16	BKP, CBAB		81816	
	103	03/05 → 07/10	1.968	D	M	4	16	BKP, CBAB		84011	<b>NEW</b>
2.0 TDI 16V 4motion	103	03/05 → 08/10	1.968	D	M	4	16	BKP, CBAB		81816	
	103	03/05 → 08/10	1.968	D	M	4	16	BKP, CBAB		84011	<b>NEW</b>
2.0 TDI 4motion	103	03/05 → 05/09	1.968	D	M	4	8	BMP		81816	
	103	03/05 → 05/09	1.968	D	M	4	8	BMP		84011	<b>NEW</b>
	103	08/09 → 01/12	1.968	D	M	4	16	CBAB, CFFB		81816	
	103	08/09 → 01/12	1.968	D	M	4	16	CBAB, CFFB		84011	<b>NEW</b>
	125	05/09 → 07/10	1.968	D	M	4	16	CBBB		81816	
	125	05/09 → 07/10	1.968	D	M	4	16	CBBB		84011	<b>NEW</b>
	125	11/09 → 01/12	1.968	D	M	4	16	CBBB, CFGB		81816	
	125	11/09 → 01/12	1.968	D	M	4	16	CBBB, CFGB		84011	<b>NEW</b>
	147	06/08 → 01/12	1.984	B	M	4	16	CAWB, CBFA, CCTA, CCZA		82025	
	155	11/10 → 01/12	1.984	B	M	4	16	CCZB		84016	<b>NEW</b>
3.2 FSI 4motion	184	11/05 → 07/10	3.168	B	M	6	24	AXZ		81866	
3.6 FSI 4motion	206	06/08 → 01/12	3.597	B	M	6	24	BLV, CNNA		81866	
	220	06/08 → 05/10	3.597	B	M	6	24	BWS		81866	
3.6 R36 4motion	220	04/07 → 07/10	3.597	B	M	6	24	BWS		81866	

**KW**

**cm<sup>3</sup>**

**NO. OF VALVES**

**VOLKSWAGEN**
**Passat VII, Variant, CC, AllTrack**

1.4 TSI	90	08/10 → 12/14	1.390	B	M	4	16	CAXA	→ 01-2009	81821
	90	08/10 → 12/14	1.390	B	M	4	16	CAXA		82097
1.6 TDI	77	08/10 → 12/14	1.598	D	M	4	16	CAYC		84001
1.8 TSI	112	02/11 → 12/14	1.798	B	M	4	16	CDAB		84016 <b>NEW</b>
	118	08/10 → 12/14	1.798	B	M	4	16	CDAA		84016 <b>NEW</b>
2.0 TDI	100	08/10 → 12/14	1.968	D	M	4	16	CFFA		84001
	103	08/10 → 12/14	1.968	D	M	4	16	CFFB		84001
	125	08/10 → 12/14	1.968	D	M	4	16	CFGB, CLLA		84001
	130	12/12 → 12/14	1.968	D	M	4	16	CFGC		84001
2.0 TDI 4motion	103	08/10 → 12/14	1.968	D	M	4	16	CFFB		84001
	125	01/12 → 12/14	1.968	D	M	4	16	CFGB		84001
	125	08/10 → 01/13	1.968	D	M	4	16	CFGB, CLLA		84001
	130	01/13 → 12/14	1.968	D	M	4	16	CFGC		84001
2.0 TSI	155	11/10 → 12/14	1.984	B	M	4	16	CCZB		84016 <b>NEW</b>
2.0 TSI 4motion	155	01/12 → 12/14	1.984	B	M	4	16	CCZB		84016 <b>NEW</b>
3.6 FSI 4motion	220	01/11 → 12/14	3.597	B	M	6	24	BWS		81866

**Passat VIII, Variant, AllTrack**

1.4 GTE Hybrid	115	06/15 →	1.395		M	4	16	CUKC		84062 <b>NEW</b>
1.4 TSI	92	11/14 →	1.395	B	M	4	16	CZCA		84062 <b>NEW</b>
	110	11/14 →	1.395	B	M	4	16	CZDA, CZEA		84062 <b>NEW</b>
1.4 TSI 4motion	110	02/15 →	1.395	B	M	4	16	CZEA		84062 <b>NEW</b>
1.8 TSI	132	02/15 →	1.798	B	M	4	16	CJSA, CJSC		84037 <b>NEW</b>
2.0 TSI	162	02/15 →	1.984	B	M	4	16	CHHB, CXDA		84037 <b>NEW</b>
2.0 TSI 4motion	162	07/15 →	1.984	B	M	4	16	CHHB		84037 <b>NEW</b>

**Phaeton**

3.0 V6 TDI 4motion	165	09/04 →	2.967	D	M	6	24	BMK		82015
	171	06/07 →	2.967	D	M	6	24	CARA		82015
	176	11/08 →	2.967	D	M	6	24	CARB, CEXA		82015
3.2 V6	177	04/02 →	3.189	B	AM	6	24	AYT, BKL		81866
3.2 V6 4motion	177	02/04 →	3.189	B	AM	6	24	BKL, BRK		81866
3.6 V6 4motion	206	11/08 →	3.597	B	M	6	24	CHNA, CMVA		81866
4.2 V8 4motion	246	05/03 →	4.172	B	M	8	40	BGH, BGJ		82081

**Polo II, Classic, Coupé, Van**

1.0	33	01/85 → 09/94	1.043	B	M	4	8	AAK, AAU, HZ	→ 07-1992, → M: 015.867	81520
	33	01/85 → 09/94	1.043	B	M	4	8	AAK, AAU, HZ	08-1992 →, M →: 015.868	81524
	33	08/92 → 07/94	1.043	B	M	4	8	AAU		81524
	33	08/85 → 01/92	1.043	B	M	4	8	HZ		81520
1.0 Cat.	33	08/89 → 09/94	1.043	B	M	4	8	AAK, AAU, ACM	→ 07-1992, → M: 015.867	81520
	33	08/89 → 09/94	1.043	B	M	4	8	AAK, AAU, ACM	08-1992 →, M →: 015.868	81524



## VOLKSWAGEN

### Polo II, Classic, Coupé, Van

1.3	40	08/92 → 07/94	1.272	B	M	4	8	AAV		81524
	57	03/91 → 09/94	1.272	B	M	4	8	3F	→ M: 008.526	81520
	57	03/91 → 09/94	1.272	B	M	4	8	3F	M →: 008.527	81524
1.3 Cat.	40	07/87 → 09/94	1.272	B	M	4	8	2G, AAV, MH, NZ	→ M: 200.000	81520
	40	07/87 → 09/94	1.272	B	M	4	8	2G, AAV, MH, NZ	M →: 200.001	81524
	40	07/87 → 09/94	1.272	B	M	4	8	MH, NZ	→ M: 200.000	81520
	40	07/87 → 09/94	1.272	B	M	4	8	MH, NZ	M →: 200.001	81524
	55	10/89 → 03/91	1.272	B	M	4	8	3F	→ M: 008.526	81520
	55	10/89 → 03/91	1.272	B	M	4	8	3F	M →: 008.527	81524
1.3 D	33	08/86 → 07/90	1.272	D	M	4	8	MN		81525
1.3 G40	83	08/90 → 09/94	1.272	B	M	4	8	PY	→ 08-1992, → M: 002.177	81520
	83	08/90 → 09/94	1.272	B	M	4	8	PY	09-1992 →, M →: 002.178	81524
	85	01/87 → 08/90	1.272	B	M	4	8	PY		81520
1.4 D	35	10/90 → 09/94	1.398	D	M	4	8	1W		81525

### Polo III (6N1), Classic, Variant, Van

1.0	33	10/94 → 12/99	1.043	B	M	4	8	AEV		81524
1.4	40	12/98 → 09/01	1.390	B	M	4	8	AKP		81775
	44	05/97 → 09/01	1.390	B	M	4	8	AEX, AKK, AKV, ANW, APQ, AUD	M: AEX, M: ANX, M: AKV, M: AEX, M: APQ, M: ANX	81527
	44	05/97 → 09/01	1.390	B	M	4	8	AEX, AKK, AKV, ANW, APQ, AUD	M: AKK, M: AUD, M: ANW, M: AKK	81775
	44	05/98 → 12/99	1.390	B	M	4	8	AEX, APQ		81527
1.4 16V	55	10/99 → 09/01	1.390	B	M	4	16	APE, AUA		81777
1.6	74	05/97 → 09/01	1.595	B	M	4	8	AEH, AFT, AKL, APF, AUR	(-)COP, M: AFT	81522
	74	05/97 → 09/01	1.595	B	M	4	8	AEH, AFT, AKL, APF, AUR	(+)COP	82080
	74	05/97 → 09/01	1.595	B	M	4	8	AEH, AFT, AKL, APF, AUR	(+)COP, M: AFT	82080
	74	05/97 → 09/01	1.595	B	M	4	8	AEH, AFT, AKL, APF, AUR	M: AUR, M: AKL, M: AEH, M: AUR, M: APF, M: AKL	81702
	55	05/97 → 09/01	1.598	B	M	4	8	AEE, ALM		81527
1.7 SDI	42	04/97 → 10/99	1.716	D	M	4	8	AHG		81528
	42	08/97 → 09/01	1.716	D	M	4	8	AKW	(-)COP	81522
	42	08/97 → 09/01	1.716	D	M	4	8	AKW	(+)COP	82080
	44	08/97 → 12/99	1.716	D	M	4	8	AKU		81528
1.8	66	05/97 → 09/01	1.781	B	M	4	8	ADZ	(-)COP	81522
	66	05/97 → 09/01	1.781	B	M	4	8	ADZ	(+)COP	82080
1.9 D	47	10/94 → 12/99	1.896	D	M	4	8	AEF		81528



		KW		cm <sup>3</sup>				NO. OF VALVES		
--	--	----	--	-----------------	--	--	--	---------------	--	--

## VOLKSWAGEN

### Polo III (6N1), Classic, Variant, Van

1.9 SDI	47	06/97 → 09/01	1.896	D	M	4	8	AEY	(-)COP	81522
	47	06/97 → 09/01	1.896	D	M	4	8	AEY	(+)COP	82080
	47	07/96 → 12/99	1.896	D	M	4	8	AGD		81528
	48	06/96 → 09/01	1.896	D	M	4	8	AEY	(+)COP	82080
	50	08/99 → 09/01	1.896	D	M	4	8	AGP, AQM		81706
1.9 TDI	66	05/97 → 09/01	1.896	D	M	4	8	AGR, AHU, ALE, ALH	(-)COP, M: ALE	81522
	66	05/97 → 09/01	1.896	D	M	4	8	AGR, AHU, ALE, ALH	(+)COP	82080
	66	05/97 → 09/01	1.896	D	M	4	8	AGR, AHU, ALE, ALH	(+)COP, M: ALE	82080
	66	05/97 → 09/01	1.896	D	M	4	8	AGR, AHU, ALE, ALH	M: AHU	81528
	66	05/97 → 09/01	1.896	D	M	4	8	AGR, AHU, ALE, ALH	M: ALH, M: AGR	81706
	81	06/98 → 09/01	1.896	D	M	4	8	AFN, ASV	M: AFN	81528
	81	06/98 → 09/01	1.896	D	M	4	8	AFN, ASV	M: ASV	81706
100 1.4 16V	74	04/96 → 10/99	1.390	B	M	4	16	AFH		81776
100 1.6	74	12/95 → 09/01	1.595	B	M	4	8	AEH, AFT, AKL, APF, AUR	(-)COP, M: AFT	81522
	74	12/95 → 09/01	1.595	B	M	4	8	AEH, AFT, AKL, APF, AUR	(+)COP	82080
	74	12/95 → 09/01	1.595	B	M	4	8	AEH, AFT, AKL, APF, AUR	(+)COP, M: AFT	82080
	74	12/95 → 09/01	1.595	B	M	4	8	AEH, AFT, AKL, APF, AUR		81702
110 1.9 TDI	81	06/98 → 01/02	1.896	D	M	4	8	AFN, ASV	(-)COP	81522
	81	06/98 → 01/02	1.896	D	M	4	8	AFN, ASV	(+)COP	82080
120 1.6 16V GTI	88	09/98 → 10/99	1.598	B	M	4	16	AJV		81840
45 1.0	33	10/94 → 09/96	1.043	B	M	4	8	AEV		81527
50 1.0	37	09/96 → 10/99	999	B	M	4	8	AER, ALL		81775
54 1.4	40	01/98 → 08/99	1.390	B	M	4	8	ANX		81527
55 1.3	40	10/94 → 07/95	1.296	B	M	4	8	ADX		81527
55 1.4	40	08/95 → 10/99	1.390	B	M	4	8	AEX		81527
57 1.7 SDI	42	07/97 → 09/01	1.716	D	M	4	8	AKW	(-)COP	81522
	42	07/97 → 09/01	1.716	D	M	4	8	AKW	(+)COP	82080
60 1.4	44	12/95 → 09/01	1.390	B	M	4	8	AEX, AKK, AKV, ANW, APQ, AUD	M: APQ, M: AKV, M: ANX, M: APQ, M: AEX, M: AKV	81527
	44	12/95 → 09/01	1.390	B	M	4	8	AEX, AKK, AKV, ANW, APQ, AUD	M: AUD, M: AKK, M: ANW, M: AUD	81775
	44	07/95 → 10/99	1.390	B	M	4	8	AEX, AKV, APQ		81527
60 1.7 SDI	44	08/97 → 10/99	1.716	D	M	4	8	AKU		81528
64 1.9 D	47	01/96 → 10/96	1.896	D	M	4	8	1Y	(-)COP	81522
	47	01/96 → 10/96	1.896	D	M	4	8	1Y	(+)COP	82080
	47	10/94 → 10/99	1.896	D	M	4	8	AEF		81528
64 1.9 SDI	47	12/95 → 08/99	1.896	D	M	4	8	1Y, AEY	(-)COP	81522
	47	12/95 → 08/99	1.896	D	M	4	8	1Y, AEY	(+)COP	82080
	47	07/96 → 10/99	1.896	D	M	4	8	AGD		81528

**KW**

**cm<sup>3</sup>**

**NO. OF VALVES**

**VOLKSWAGEN**
**Polo III (6N1), Classic, Variant, Van**

68 1.9 SDI	50	08/99 → 01/02	1.896	D	M	4	8	AGP, AQM		81706
75 1.4 16V	55	10/99 → 09/01	1.390	B	M	4	16	APE, AUA		81777
75 1.6	55	11/95 → 09/97	1.595	B	M	4	8	1F	(-)COP	81522
	55	11/95 → 09/97	1.595	B	M	4	8	1F	(+)COP	82080
	55	10/94 → 10/99	1.598	B	M	4	8	AEA, AEE, AHS		81527
	55	11/95 → 09/01	1.598	B	M	4	8	AEE, ALM		81527
90 1.8	66	01/97 → 09/01	1.781	B	M	4	8	ABS, ADD, ADZ	(-)COP	81522
	66	01/97 → 09/01	1.781	B	M	4	8	ABS, ADD, ADZ	(+)COP	82080
90 1.9 TDI	66	09/96 → 09/01	1.896	D	M	4	8	AGR, AHU, ALE, ALH	(-)COP, M: ALE	81522
	66	09/96 → 09/01	1.896	D	M	4	8	AGR, AHU, ALE, ALH	(+)COP	82080
	66	09/96 → 09/01	1.896	D	M	4	8	AGR, AHU, ALE, ALH	(+)COP, M: ALE	82080
	66	09/96 → 09/01	1.896	D	M	4	8	AGR, AHU, ALE, ALH	M: AHU	81528
	66	09/96 → 09/01	1.896	D	M	4	8	AGR, AHU, ALE, ALH	M: ALH, M: AGR	81706

**Polo IV (6N2)**

1.0	37	10/99 → 09/01	999	B	M	4	8	ALD, AUC		81775
1.4	40	10/99 → 09/01	1.390	B	M	4	8	AKP, ANX		81775
	44	10/99 → 09/01	1.390	B	M	4	8	AKK, AUD		81775
1.4 16V	55	10/99 → 09/01	1.390	B	M	4	16	AHW, APE, AUA		81777
	74	10/99 → 09/01	1.390	B	M	4	16	AFK, AQQ, AUB		81777
1.4 TDI	55	10/99 → 09/01	1.422	D	M	3	6	AMF		84010 <b>NEW</b>
	55	10/99 → 09/01	1.422	D	M	3	6	AMF		81791
	66	01/00 → 10/00	1.422	D	M	3	6	ATL		84010 <b>NEW</b>
	66	01/00 → 10/00	1.422	D	M	3	6	ATL		81791
1.6 16V GTI	92	10/99 → 09/01	1.598	B	M	4	16	ARC, AVY		81840
1.7 SDI	44	10/99 → 09/01	1.716	D	M	4	8	AKU		81528
1.9 D	47	10/99 → 09/01	1.896	D	M	4	8	AEF		81528
1.9 SDI	47	10/99 → 09/01	1.896	D	M	4	8	AGD, ASX		81528

**Polo V (9N)**

1.2	40	01/02 → 05/07	1.198	B	M	3	6	AWY, BMD		81867
	44	05/07 → 11/09	1.198	B	M	3	6	BBM		81867
1.2 12V	47	10/01 → 07/07	1.198	B	M	3	12	AZQ, BME		81867
	51	05/07 → 11/09	1.198	B	M	3	12	BZG		81867
1.4	55	07/03 →	1.390	B	M	4	16	BBY, BKY		81777
	63	06/05 → 11/09	1.390	B	M	4	8			81777
	74	11/03 →	1.390	B	M	4	16	BBZ		81777
1.4 16V	55	10/01 → 05/08	1.390	B	AM	4	16	AUA, BBY, BKY		81777
	59	05/06 → 11/09	1.390	B	M	4	16	BUD		81777
	74	10/01 → 05/08	1.390	B	M	4	16	AUB, BBZ		81777
1.4 FSI	63	02/02 → 07/06	1.390	B	M	4	16	AXU		81865

		KW		cm <sup>3</sup>				NO. OF VALVES		
--	--	----	--	-----------------	--	--	--	---------------	--	--

## VOLKSWAGEN

### Polo V (9N)

1.4 TDI	51	04/05 → 11/09	1.422	D	M	3	6	BNM, BWB		84010	<b>NEW</b>
	51	04/05 → 11/09	1.422	D	M	3	6	BNM, BWB		81791	
	55	10/01 → 06/05	1.422	D	M	3	6	AMF, BAY		84010	<b>NEW</b>
	55	10/01 → 06/05	1.422	D	M	3	6	AMF, BAY		81791	
	55	07/03 →	1.422	D	M	3	6	BAY		84010	<b>NEW</b>
	55	07/03 →	1.422	D	M	3	6	BAY		81791	
	59	04/05 → 11/09	1.422	D	M	3	6	BMS, BNV		84010	<b>NEW</b>
	59	04/05 → 11/09	1.422	D	M	3	6	BMS, BNV		81791	
1.6	74	08/02 → 05/05	1.598	B	M	4	8	BAH		81527	
	74	09/02 →	1.598	B	M	4	8	BAH, BPA, CFZA		81527	
1.6 16V	77	05/06 → 11/09	1.598	B	M	4	16	BTS		81865	
1.8 GTI	110	09/05 → 11/09	1.781	B	M	4	20	BJX		81703	
1.8 GTI Cup Edition	132	05/06 → 11/09	1.781	B	M	4	20	BBU		81703	
1.9 SDI	47	10/01 → 11/09	1.896	D	M	4	8	ASY	→ T: 9N2100000	84052	<b>NEW</b>
	47	10/01 → 11/09	1.896	D	M	4	8	ASY	T →: 9N2100001	82013	
	47	09/02 →	1.896	D	M	4	8	ASY		82013	
1.9 TDi	74	09/02 →	1.896	D	M	4	8	ATD		84010	<b>NEW</b>
	74	09/02 →	1.896	D	M	4	8	ATD		81791	
	74	10/01 → 11/09	1.896	D	M	4	8	ATD, AXR, BMT		84010	<b>NEW</b>
	74	10/01 → 11/09	1.896	D	M	4	8	ATD, AXR, BMT		81791	
	96	11/03 → 11/09	1.896	D	M	4	8	ASZ, BLT		84010	<b>NEW</b>
	96	11/03 → 11/09	1.896	D	M	4	8	ASZ, BLT		81791	

### Polo VI (6R)

1.0 TSI	70	11/14 →	999	B	M	3	12	CHZB		84062	<b>NEW</b>
1.2	44	06/09 →	1.198	B	M	3	12	CGPB		81867	
	51	06/09 →	1.198	B	M	3	12	CGPA		81867	
1.2 TDI	55	10/09 →	1.199	D	M	3	12	CFWA		84001	
1.2 TSI	66	05/11 → 05/14	1.197	B	M	4	8	CBZC		84045	<b>NEW</b>
	77	11/09 →	1.197	B	M	4	8	CBZB		84045	<b>NEW</b>
	81	01/14 →	1.197	B	M	4	16	CJZD		84062	<b>NEW</b>
1.2 TSI 16V	66	02/14 →	1.197	B	M	4	16	CJZC		84062	<b>NEW</b>
1.4	63	06/09 →	1.390	B	M	4	16	CDDA, CGGB, CLPA		81777	
1.4 BiFuel	60	03/10 → 01/11	1.390	BF	M	4	16	CMAA		81777	
1.4 TSI	103	10/12 →	1.395	B	M	4	16	CPTA		84062	<b>NEW</b>
	110	05/14 →	1.395	B	M	4	16	CZEA		84062	<b>NEW</b>
1.6	63	11/10 →	1.598	B	M	4	16	CFNB		81777	
	77	05/10 →	1.598	B	M	4	16	CFNA, CLSA		81865	
	81	07/14 →	1.598	B	M	4	16	CWVA		84062	<b>NEW</b>
1.6 BiFuel	60	01/11 →	1.598	BF	M	4	16	CNKA		81777	
1.6 TDI	55	06/09 →	1.598	D	M	4	16	CAYA		84001	
	66	06/09 →	1.598	D	M	4	16	CAYB		84001	
	77	06/09 →	1.598	D	M	4	16	CAYC, CLNA		84001	
1.8 GTI	136	11/14 →	1.798	B	M	4	16	CWYA		84037	<b>NEW</b>
	141	11/14 →	1.798	B	M	4	16	DAJA, DAJB		84037	<b>NEW</b>

**KW**

**cm<sup>3</sup>**

**NO. OF VALVES**

**MAGNETI MARELLI**
**VOLKSWAGEN**
**Polo VI (6R)**

2.0 R WRC	162	08/13 →	1.984	B	M	4	16	CDLJ		82025
-----------	-----	---------	-------	---	---	---	----	------	--	-------

**Scirocco II**

1.6	53	04/86 → 07/90	1.595	B	M	4	8	RE	(-)COP	81522
	53	04/86 → 07/90	1.595	B	M	4	8	RE	(+)COP	82080
1.8	66	08/83 → 07/92	1.781	B	M	4	8	EX	(-)COP	81522
	66	08/83 → 07/92	1.781	B	M	4	8	EX	(+)COP	82080
	70	11/85 → 07/92	1.781	B	M	4	8	JH	(-)COP	81522
	70	11/85 → 07/92	1.781	B	M	4	8	JH	(+)COP	82080
1.8 16V	95	03/86 → 07/92	1.781	B	M	4	16	PL	(-)COP	81522
	95	03/86 → 07/92	1.781	B	M	4	16	PL	(+)COP	82080

**Scirocco III**

1.4 TSI	90	08/08 →	1.390	B	M	4	16	CAXA, CMSB		82097
2.0 R	188	11/09 →	1.984	B	M	4	16	CDLC		82025
	195	11/09 →	1.984	B	M	4	16	CDLA		82025
	206	05/14 →	1.984	B	M	4	16	CDLK		84037 <b>NEW</b>
2.0 TDI	100	11/10 →	1.968	D	M	4	16	CFHB		84001
	103	08/08 →	1.968	D	M	4	16	CBDB, CFHC		81816
	103	08/08 →	1.968	D	M	4	16	CBDB, CFHC		84011 <b>NEW</b>
	125	05/09 →	1.968	D	M	4	16	CBBB, CFGB		81816
	125	05/09 →	1.968	D	M	4	16	CBBB, CFGB		84011 <b>NEW</b>
	130	01/13 →	1.968	D	M	4	16	CFGC		84001
2.0 TSI	132	11/13 →	1.984	B	M	4	16	CULA		84037 <b>NEW</b>
	147	05/08 → 11/09	1.984	B	M	4	16	CAWB		84016 <b>NEW</b>
	155	11/09 →	1.984	B	M	4	16	CCZB		84016 <b>NEW</b>
	162	11/13 →	1.984	B	M	4	16	CULC		84037 <b>NEW</b>

**Sharan I**

1.8 T 20V	110	09/97 → 03/10	1.781	B	M	4	20	AJH, AWC		81703
1.9 TDI	66	09/95 → 03/10	1.896	D	M	4	8	1Z, AHU, ANU	(-)COP, 09-1995 →, → 0 3-2000, M: AHU, M: 1Z	81522
	66	09/95 → 03/10	1.896	D	M	4	8	1Z, AHU, ANU	(+)COP	82080
	66	09/95 → 03/10	1.896	D	M	4	8	1Z, AHU, ANU	(+)COP, 09-1995 →, → 03-2000, M: 1Z, M: AHU	82080
	66	09/95 → 03/10	1.896	D	M	4	8	1Z, AHU, ANU	03-2000 →, M: ANU	81816
	66	09/95 → 03/10	1.896	D	M	4	8	1Z, AHU, ANU		84011 <b>NEW</b>
	81	09/96 → 04/00	1.896	D	M	4	8	AFN, AVG	(-)COP	81522
	81	09/96 → 04/00	1.896	D	M	4	8	AFN, AVG	(+)COP	82080
	85	04/00 → 03/10	1.896	D	M	4	8	AUY, BVK		81816
	85	04/00 → 03/10	1.896	D	M	4	8	AUY, BVK		84011 <b>NEW</b>
	96	11/02 → 03/10	1.896	D	M	4	8	ASZ		84010 <b>NEW</b>
	96	11/02 → 03/10	1.896	D	M	4	8	ASZ		81791
	110	06/05 → 03/10	1.896	D	M	4	8	BTB		84010 <b>NEW</b>
	110	06/05 → 03/10	1.896	D	M	4	8	BTB		81791

							NO. OF VALVES		
--	--	--	--	--	--	--	---------------	--	--

## VOLKSWAGEN

### Sharan I

1.9 TDI 4motion	85	04/00 → 03/10	1.896	D	M	4	8	AUY, BVK		81816
	85	04/00 → 03/10	1.896	D	M	4	8	AUY, BVK		84011
2.0	85	09/95 → 03/10	1.984	B	M	4	8	ADY, ATM	(-)COP, 09-1995 →, → 02-2000, M: ADY	81522
	85	09/95 → 03/10	1.984	B	M	4	8	ADY, ATM	(+)COP	82080
	85	09/95 → 03/10	1.984	B	M	4	8	ADY, ATM	(+)COP, 09-1995 →, → 02-2000, M: ADY	82080
	85	09/95 → 03/10	1.984	B	M	4	8	ADY, ATM	03-2000 →, M: ATM	81703
2.0 LPG	85	04/06 → 03/10	1.984		M	4	8	ATM		81703
2.0 TDI	100	11/05 → 03/10	1.968	D	M	4	8	BVH		81816
	100	11/05 → 03/10	1.968	D	M	4	8	BVH		84011
	103	11/05 → 03/10	1.968	D	M	4	8	BRT		81816
	103	11/05 → 03/10	1.968	D	M	4	8	BRT		84011
2.8 V6 24V	150	04/00 → 03/10	2.792	B	M	6	24	AYL	→ T: 035.000	81773
	150	04/00 → 03/10	2.792	B	M	6	24	AYL	T →: 035.001	81866
2.8 V6 24V 4motion	150	04/00 → 03/10	2.792	B	M	6	24	AYL	→ T: 035.000	81773
	150	04/00 → 03/10	2.792	B	M	6	24	AYL	T →: 035.001	81866
2.8 VR6	128	09/95 → 04/00	2.792	B	M	6	12	AAA, AMY	09-1995 →	81773
2.8 VR6 Syncro	128	11/96 → 04/00	2.792	B	M	6	12	AAA, AMY	09-1995 →	81773

### Sharan II

1.4 TSI	110	05/15 →	1.395	B	M	4	16	CZDA		84062
2.0 TDI	85	05/11 →	1.968	D	M	4	16	CFFE, CUVA		84001
	100	05/10 →	1.968	D	M	4	16	CFFA		84001
	103	05/10 →	1.968	D	M	4	16	CFFB		84001
	125	08/10 →	1.968	D	M	4	16	CFGB		84001
	130	01/13 →	1.968	D	M	4	16	CFGC		84001
2.0 TDI 4motion	100	05/11 → 05/12	1.968	D	M	4	16	CFFA		84001
	103	05/11 →	1.968	D	M	4	16	CFFB		84001
2.0 TSI	147	12/10 →	1.984	B	M	4	16	CCZA		84016
	162	05/15 →	1.984	B	M	4	16	DEDA		84037

### Tiguan I

1.4 TSI	90	08/10 →	1.390	B	M	4	16	CAXA		82097
	92	05/15 →	1.395	B	M	4	16	CZDB		84062
	110	05/15 →	1.395	B	M	4	16	CZDA		84062
2.0 TDI	81	05/10 →	1.968	D	M	4	16	CFFD		84001
	103	03/08 →	1.968	D	M	4	16	CBAB, CFFB		81816
	103	03/08 →	1.968	D	M	4	16	CBAB, CFFB		84011

**KW**

**cm<sup>3</sup>**

**NO. OF  
VALVES**

**MAGNETI  
MARELLI**
**VOLKSWAGEN**
**Tiguan I**

2.0 TDI 4motion	100	11/07 →	1.968	D	M	4	16	CBAA, CFFA		81816	
	100	11/07 →	1.968	D	M	4	16	CBAA, CFFA		84011	<b>NEW</b>
	103	09/07 →	1.968	D	M	4	16	CBAB, CFFB, CLJA		81816	
	103	09/07 →	1.968	D	M	4	16	CBAB, CFFB, CLJA		84011	<b>NEW</b>
	120	02/08 → 08/09	1.968	D	M	4	16	CBBA		81816	
	120	02/08 → 08/09	1.968	D	M	4	16	CBBA		84011	<b>NEW</b>
	125	09/07 →	1.968	D	M	4	16	CBBB, CFGB		81816	
	125	09/07 →	1.968	D	M	4	16	CBBB, CFGB		84011	<b>NEW</b>
	130	11/12 →	1.968	D	M	4	16	CFGC		84001	
2.0 TFSI 4motion	125	09/07 →	1.984	B	M	4	16	CAWA, CCZC		84016	<b>NEW</b>
	147	09/07 →	1.984	B	M	4	16	CAWB, CCTA, CCZA		84016	<b>NEW</b>
2.0 TSI 4motion	132	05/11 →	1.984	B	M	4	16	CCZD		84016	<b>NEW</b>
	155	05/11 →	1.984	B	M	4	16	CCZB		84016	<b>NEW</b>

**Tiguan II**

2.0 TSI 4motion	132	02/16 →	1.984	B	M	4	16			84037	<b>NEW</b>
-----------------	-----	---------	-------	---	---	---	----	--	--	-------	------------

**Touareg I**

2.5 R5 TDI	120	08/03 → 05/10	2.461	D	M	5	10	BLK, BPD		82033	
	128	01/03 → 05/10	2.461	D	M	5	10	BAC, BPE		82033	
3.0 TDI	155	04/06 → 05/10	2.967	D	M	6	24	BUN, CASB		82015	
3.0 V6 TDI	165	11/04 → 05/10	2.967	D	M	6	24	BKS, CATA		82015	
	176	11/07 → 05/10	2.967	D	M	6	24	CASA, CASC		82015	
3.2 V6	162	10/02 → 11/06	3.189	B	M	6	24	AZZ, BAA, BKJ, BMV, BMX, BRJ		81866	
	177	11/04 → 11/06	3.189	B	M	6	24	BMV		81866	
3.6 V6 FSI	206	10/05 → 05/10	3.597	B	M	6	24	BHK, BHL		81866	
4.2 V8	228	12/02 → 11/06	4.172	B	M	8	40	AXQ, BHX		82081	

**Touareg II**

3.0 V6 TDI	150	01/10 →	2.967	D	M	6	24	CASD, CJMA, CVWA		84021	<b>NEW</b>
	165	06/10 →	2.967	D	M	6	24	CATA		82015	
	176	01/10 →	2.967	D	M	6	24	CASA, CNRB		82015	
	180	05/11 →	2.967	D	M	6	24	CJGD, CRCA		84021	<b>NEW</b>
	193	09/14 →	2.967	D	M	6	24	CVVA		84021	<b>NEW</b>

**Touran I**

1.2 TSI	77	05/10 → 05/15	1.197	B	M	4	8	CBZB		84045	<b>NEW</b>
1.6	75	07/03 → 05/10	1.595	B	M	4	8	BGU, BSE, BSF		81702	
1.6 FSI	85	02/03 → 01/07	1.598	B	M	4	16	BAG, BLF, BLP		81865	
1.6 TDI	66	05/10 → 05/15	1.598	D	M	4	16	CAYB		84001	
	77	05/10 → 05/15	1.598	D	M	4	16	CAYC		84001	
1.9 TDI	66	11/04 → 05/10	1.896	D	M	4	8	BRU, BXF, BXJ		84010	<b>NEW</b>
	66	11/04 → 05/10	1.896	D	M	4	8	BRU, BXF, BXJ		81791	
	74	02/03 → 05/04	1.896	D	M	4	8	AVQ		84010	<b>NEW</b>
	74	02/03 → 05/04	1.896	D	M	4	8	AVQ		81791	
	77	08/03 → 05/10	1.896	D	M	4	8	BKC, BLS, BXE		84010	<b>NEW</b>
77	08/03 → 05/10	1.896	D	M	4	8	BKC, BLS, BXE		81791		

		<b>KW</b>		<b>cm<sup>3</sup></b>				<b>NO. OF VALVES</b>		
--	--	-----------	--	-----------------------	--	--	--	----------------------	--	--

## VOLKSWAGEN

### Touran I

2.0 EcoFuel	80	02/06 → 05/09	1.984	M	M	4	8	BSX		81703
2.0 FSI	85	10/04 → 05/10	1.984	B	M	4	16	BJZ		81702
	110	10/03 → 01/07	1.984	B	M	4	16	AXW, BLR, BLX, BLY, BVY, BVZ		81702
2.0 TDI	81	11/10 → 05/15	1.968	D	M	4	16	CFHF, CLCA		84001
	100	02/03 → 05/10	1.968	D	M	4	16	AZV		81816
	100	02/03 → 05/10	1.968	D	M	4	16	AZV		84011 <b>NEW</b>
	103	12/05 → 05/10	1.968	D	M	4	8	BMM		81816
	103	12/05 → 05/10	1.968	D	M	4	8	BMM		84011 <b>NEW</b>
	103	05/10 → 05/15	1.968	D	M	4	16	CFHC		84001
	125	12/05 → 05/10	1.968	D	M	4	16	BMN, CFJA		81816
	125	12/05 → 05/10	1.968	D	M	4	16	BMN, CFJA		84011 <b>NEW</b>
	125	05/10 → 01/13	1.968	D	M	4	16	CFJA		84001
2.0 TDI 16V	130	01/13 → 05/15	1.968	D	M	4	16	CFJB		84001
	103	08/03 → 05/10	1.968	D	M	4	16	BKD		81816
	103	08/03 → 05/10	1.968	D	M	4	16	BKD		84011 <b>NEW</b>

### Touran II

1.2 TSI	81	05/15 →	1.197	B	M	4	16	CYVB		84062 <b>NEW</b>
1.4 TSI	110	05/15 →	1.395	B	M	4	16	CZDA		84062 <b>NEW</b>

### Transporter III

1.6 TD	51	08/84 → 07/92	1.589	D	M	4	8	JX	(-)COP, → M: 012.052	81521
	51	08/84 → 07/92	1.589	D	M	4	8	JX	(-)COP, M →: 012.053	81522
	51	08/84 → 07/92	1.589	D	M	4	8	JX	(+)COP	82080
	51	08/84 → 07/92	1.589	D	M	4	8	JX	(+)COP, → M: 012.052	82001
	51	08/84 → 07/92	1.589	D	M	4	8	JX	(+)COP, M →: 012.053	82080
1.6 TD Syncro	51	03/86 → 07/92	1.589	D	M	4	8	JX	(-)COP, → M: 012.052	81521
	51	03/86 → 07/92	1.589	D	M	4	8	JX	(-)COP, M →: 012.053	81522
	51	03/86 → 07/92	1.589	D	M	4	8	JX	(+)COP	82080
	51	03/86 → 07/92	1.589	D	M	4	8	JX	(+)COP, → M: 012.052	82001
	51	03/86 → 07/92	1.589	D	M	4	8	JX	(+)COP, M →: 012.053	82080
1.7 D	42	10/86 → 07/92	1.716	D	M	4	8	KY	(-)COP	81522
	42	10/86 → 07/92	1.716	D	M	4	8	KY	(+)COP	82080
2.1	64	10/86 → 07/92	2.109	B	M	4	8	SR		81832
	70	08/85 → 07/92	2.110	B	M	4	8	MV		81832
	82	08/84 → 07/92	2.110	B	M	4	8	DJ		81832
2.1 Cat.	70	06/89 → 07/92	2.110	B	M	4	8	MV		81832

**KW**

**cm<sup>3</sup>**

**NO. OF VALVES**

**MAGNETI MARELLI**
**VOLKSWAGEN**
**Transporter III**

2.1 i	68	07/89 → 07/92	2.110	B	M	4	8	SS		81832
2.1 Syncro	64	10/86 → 07/92	2.109	B	M	4	8	SR		81832
	70	08/85 → 07/92	2.110	B	M	4	8	MV		81832
	82	01/86 → 07/92	2.110	B	M	4	8	DJ		81832

**Transporter IV**

1.8	49	12/90 → 07/92	1.781	B	M	4	8	PD	(-)COP	81522
	49	12/90 → 07/92	1.781	B	M	4	8	PD	(+)COP	82080
1.9 D	44	09/90 → 12/95	1.896	D	M	4	8	1X	(-)COP	81522
	44	09/90 → 12/95	1.896	D	M	4	8	1X	(+)COP	82080
	45	07/90 → 12/95	1.896	D	M	4	8	1X	(-)COP	81522
	45	07/90 → 12/95	1.896	D	M	4	8	1X	(+)COP	82080
1.9 TD	50	10/92 → 04/03	1.896	D	M	4	8	ABL	(-)COP	81522
	50	10/92 → 04/03	1.896	D	M	4	8	ABL	(+)COP	82080
2.0	62	07/90 → 04/03	1.968	B	M	4	8	AAC	(-)COP, 09-1990 →	81522
	62	07/90 → 04/03	1.968	B	M	4	8	AAC	(+)COP, 09-1990 →	82080
	62	09/90 → 04/03	1.968	B	M	4	8	AAC	(-)COP	81522
	62	09/90 → 04/03	1.968	B	M	4	8	AAC	(+)COP	82080
2.4 D	55	08/97 → 04/03	2.370	D	M	5	10	AJA		81701
	57	07/90 → 04/98	2.370	D	M	5	10	AAB	09-1990 →, → 07-1995, T →: F70.N.014.000	81772
	57	09/90 → 04/98	2.370	D	M	5	10	AAB	→ 07-1995, → T: F70-N-014.000	81772
2.4 D Syncro	57	09/90 → 04/98	2.370	D	M	5	10	AAB	08-1995 →, T →: F70.N.014.001	81701
	57	10/92 → 09/98	2.370	D	M	5	10	AAB	08-1995 →, T →: F70.N.014.001	81701
	57	10/92 → 09/98	2.370	D	M	5	10	AAB	09-1990 →, → 07-1995, T →: F70.N.014.000	81772
2.5	81	11/90 → 04/03	2.461	B	M	5	10	AAF, ACU, AEN, AEU	→ T: F70.N.014.000	81772
	81	11/90 → 04/03	2.461	B	M	5	10	AAF, ACU, AEN, AEU	T →: F70.N.014.001, M: AEN, M: AEU, M: AEN	81701
	85	08/96 → 04/03	2.461	B	M	5	10	AET, APL, AVT		81701
2.5 Syncro	81	10/92 → 04/03	2.461	B	M	5	10	AAF, ACU, AEN, AEU	T →: F70.N.014.001, M: AEN, M: AEU, M: AEN	81701
	81	11/92 → 04/03	2.461	B	M	5	10	AAF, ACU, AEN, AEU	→ T: F70.N.014.000	81772
	81	11/92 → 04/03	2.461	B	M	5	10	AAF, ACU, AEN, AEU	T →: F70.N.014.001, M: AEU, M: AEN, M: AEU	81701
	85	07/96 → 04/03	2.461	B	M	5	10	AET, APL, AVT		81701



**KW**

**cm<sup>3</sup>**

**NO. OF VALVES**

**VOLKSWAGEN**
**Transporter IV**

2.5 TDI	65	05/98 → 04/03	2.461	D	M	5	10	AJT, AYY		81701
	75	09/95 → 04/03	2.461	D	M	5	10	ACV, AUF, AXL, AYC		81701
	75	09/95 → 04/03	2.461	D	M	5	10	ACV, AUF, AYC		81701
	111	05/98 → 04/03	2.461	D	M	5	10	AHY, AXG		81701
	111	09/00 → 04/03	2.461	D	M	5	10	AXG		81701
2.5 TDI Syncro	75	01/96 → 04/03	2.461	D	M	5	10	ACV, AXL		81701
2.8	103	05/96 → 05/00	2.792	B	M	6	12	AES		81773
2.8 VR6	103	11/95 → 04/00	2.792	B	M	6	12	AES		81773
	150	04/00 → 04/03	2.792	B	M	6	24	AMV		81773
	150	06/00 → 04/03	2.792	B	M	6	24	AMV		81866
2.8 VR6 Syncro	103	01/96 → 04/96	2.792	B	M	6	12	AES		81773

**Transporter V**

1.9 TDI	62	01/06 → 11/09	1.896	D	M	4	8	BRR		84010	<b>NEW</b>
	62	01/06 → 11/09	1.896	D	M	4	8	BRR		81791	
	63	04/03 → 11/09	1.896	D	M	4	8	AXC		84010	<b>NEW</b>
	63	04/03 → 11/09	1.896	D	M	4	8	AXC		81791	
	75	06/06 → 11/09	1.896	D	M	4	8	BRS		84010	<b>NEW</b>
	75	06/06 → 11/09	1.896	D	M	4	8	BRS		81791	
	77	04/03 → 11/09	1.896	D	M	4	8	AXB		84010	<b>NEW</b>
	77	04/03 → 11/09	1.896	D	M	4	8	AXB		81791	
2.0	85	11/03 →	1.984	B	M	4	8	AXA		81703	
2.0 BITDI	132	09/09 →	1.968	D	M	4	16	CFCA		84001	
2.0 BiTDI 4motion	132	09/09 →	1.968	D	M	4	16	CFCA		84001	
2.0 TDI	62	09/09 →	1.968	D	M	4	16	CAAA		84001	
	75	09/09 →	1.968	D	M	4	16	CAAB		84001	
	84	05/11 →	1.968	D	M	4	16	CAAD		84001	
	100	05/10 →	1.968	D	M	4	16	CAAE		84001	
	100	05/10 →	1.968	D	M	4	16	CAAE, CCHB		84001	
	103	09/09 →	1.968	D	M	4	16	CAAC		84001	
	103	09/09 →	1.968	D	M	4	16	CAAC, CCHA		84001	
2.0 TDI 4motion	100	05/10 →	1.968	D	M	4	16	CAAE, CCHB		84001	
	103	09/09 →	1.968	D	M	4	16	CAAC		84001	
	103	09/09 →	1.968	D	M	4	16	CAAC, CCHA		84001	
2.0 TSI	110	07/12 →	1.984	B	M	4	16	CJKB		84016	<b>NEW</b>
	150	05/11 →	1.984	B	M	4	16	CJKA		84016	<b>NEW</b>
2.0 TSI 4motion	150	07/11 →	1.984	B	M	4	16	CJKA		84016	<b>NEW</b>
2.5 TDI	96	04/03 → 11/09	2.461	D	M	5	10	AXD, BNZ		82033	
	120	11/03 → 11/09	2.461	D	M	5	10	BLJ		82033	
	128	04/03 → 11/09	2.461	D	M	5	10	AXE, BPC		82033	
2.5 TDI 4motion	96	07/04 → 11/09	2.461	D	M	5	10	AXD, BNZ		82033	
	128	07/04 → 11/09	2.461	D	M	5	10	AXE, BPC		82033	
3.2 4motion	173	11/03 → 11/09	3.189	B	M	6	24	BKK, CFLA		81866	

**KW**

**cm<sup>3</sup>**

**NO. OF VALVES**

**VOLKSWAGEN**
**Transporter V**

3.2 V6	170	02/04 → 06/04	3.189	B	M	6	24	BDL		81866
	173	08/03 → 05/06	3.189	B	M	6	24	BKK		81866
	173	02/04 → 11/09	3.189	B	M	6	24	BKK, CFLA		81866
3.2 V6 4motion	173	11/03 → 11/09	3.189	B	M	6	24	BKK, CFLA		81866

**Vento**

1.4	40	11/91 → 09/98	1.390	B	M	4	8	ABD, AEX	M: ABD	81524
	40	11/91 → 09/98	1.390	B	M	4	8	ABD, AEX	M: AEX	81527
	44	11/91 → 09/98	1.390	B	M	4	8	ABD, AEX	M: ABD	81524
	44	11/91 → 09/98	1.390	B	M	4	8	ABD, AEX	M: AEX	81527
1.6	74	10/94 → 09/98	1.595	B	M	4	8	AEK, AFT	(-)COP	81522
	74	10/94 → 09/98	1.595	B	M	4	8	AEK, AFT	(+)COP	82080
	55	09/92 → 09/98	1.598	B	M	4	8	ABU, AEA, AEE	M: ABU	81524
	55	09/92 → 09/98	1.598	B	M	4	8	ABU, AEA, AEE	M: AEE, M: AEA	81527
1.8	55	11/91 → 09/98	1.781	B	M	4	8	AAM	(-)COP	81522
	55	11/91 → 09/98	1.781	B	M	4	8	AAM	(+)COP	82080
	66	11/91 → 09/98	1.781	B	M	4	8	ABS, ADZ	(-)COP	81522
	66	11/91 → 09/98	1.781	B	M	4	8	ABS, ADZ	(+)COP	82080
1.9 D	48	11/91 → 09/98	1.896	D	M	4	8	1Y	(-)COP	81522
	48	11/91 → 09/98	1.896	D	M	4	8	1Y	(+)COP	82080
1.9 SDI	47	04/97 → 09/98	1.896	D	M	4	8	AEY	(-)COP	81522
	47	04/97 → 09/98	1.896	D	M	4	8	AEY	(+)COP	82080
1.9 TD	55	11/91 → 09/98	1.896	D	M	4	8	AAZ	(-)COP	81522
	55	11/91 → 09/98	1.896	D	M	4	8	AAZ	(+)COP	82080
1.9 TDI	66	09/93 → 09/98	1.896	D	M	4	8	1Z, AHU, ALE	(-)COP	81522
	66	09/93 → 09/98	1.896	D	M	4	8	1Z, AHU, ALE	(+)COP	82080
	81	04/96 → 09/98	1.896	D	M	4	8	AFN	(-)COP	81522
	81	04/96 → 09/98	1.896	D	M	4	8	AFN	(+)COP	82080
2.0	85	11/91 → 09/98	1.984	B	M	4	8	2E, ADY, AGG, AKR	(-)COP	81522
	85	11/91 → 09/98	1.984	B	M	4	8	2E, ADY, AGG, AKR	(+)COP	82080
2.0 GL	62	11/91 → 07/98	1.968	B	M	4	8	AAC	(-)COP	81522
	62	11/91 → 07/98	1.968	B	M	4	8	AAC	(+)COP	82080
	79	05/96 → 12/97	1.984	B	M	4	8	AEP	(-)COP	81522
	79	05/96 → 12/97	1.984	B	M	4	8	AEP	(+)COP	82080
2.8 VR6	120	08/95 → 04/96	2.792	B	M	6	12	AAA		81773
	128	01/92 → 09/98	2.792	B	M	6	12	AAA		81773

**VOLVO**
**240, Station Wagon**

2.0	86	08/83 → 07/93	1.986	B	M	4	8	B200E		81594
2.3 Cat.	100	08/91 → 07/92	2.316	B	M	4	8	B230F		81594
2.3 i Cat.	85	08/86 → 07/93	2.316	B	M	4	8	B230F	09-1984 →, → 12-1993	81594
	85	08/86 → 07/93	2.316	B	M	4	8	B230F		81594

**KW**

**cm<sup>3</sup>**

**NO. OF VALVES**

**VOLVO**
**240, Station Wagon**

2.4 Diesel	58	08/87 → 08/93	2.383	D	M	6	12	D24	01-1979 →, → 12-1993	81593
	58	08/88 → 08/93	2.383	D	M	6	12	D24		81593

**340 - 360**

1.6 Diesel	40	08/84 → 07/91	1.596	D	M	4	8	D16		81574
1.7	59	08/85 → 07/91	1.721	B	M	4	8	B172K		81574

**440**

1.6	61	09/88 → 12/96	1.596	B	M	4	8	B16F		81574	
	1.7	64	09/88 → 12/96	1.721	B	M	4	8	B18KP		81574
		75	08/89 → 12/96	1.721	B	M	4	8	B18FP		81574
		78	09/88 → 12/96	1.721	B	M	4	8	B18EP		81574
1.7 Turbo		88	08/88 → 07/96	1.721	B	M	4	8	B18FT		81574
	90	01/91 → 12/96	1.721	B	M	4	8	B18FT		81574	
1.8	66	08/91 → 12/96	1.794	B	M	4	8	B18U		81574	
1.9 Turbo-Diesel	66	07/94 → 12/96	1.870	D	M	4	8	D19T		81574	
2.0	80	08/93 → 07/96	1.998	B	M	4	8	B20F		81574	
	81	08/92 → 07/95	1.998	B	M	4	8	B20F		81574	

**460**

1.6	61	07/92 → 07/96	1.596	B	M	4	8	B16F		81574	
	1.7	64	09/88 → 07/96	1.721	B	M	4	8	B18KP		81574
		66	09/90 → 07/96	1.721	B	M	4	8	B18KP		81574
		75	08/89 → 07/92	1.721	B	M	4	8	B18EP		81574
		80	08/89 → 07/92	1.721	B	M	4	8	B18E		81574
1.7 Turbo		88	08/89 → 07/96	1.721	B	M	4	8	B18FT		81574
	90	01/91 → 07/96	1.721	B	M	4	8	B18FT		81574	
1.8	66	08/91 → 07/96	1.794	B	M	4	8	B18U		81574	
1.9 Turbo-Diesel	66	07/94 → 07/96	1.870	D	M	4	8	D19T		81574	
2.0	80	08/93 → 07/96	1.998	B	M	4	8	B20F		81574	
	81	08/92 → 07/95	1.998	B	M	4	8	B20F		81574	

**480**

1.7	75	08/89 → 07/96	1.721	B	M	4	8	B18EP		81574
1.7 Turbo	88	08/87 → 07/96	1.721	B	M	4	8	B18FT		81574
	90	01/91 → 07/96	1.721	B	M	4	8	B18FT		81574
2.0	81	08/92 → 09/95	1.998	B	M	4	8	B20F		81574

**740, Station Wagon**

2.0	76	09/88 → 08/90	1.986	B	M	4	8	B200K		81594
	82	09/90 → 08/92	1.986	B	M	4	8	B200F		81594
	89	08/85 → 07/92	1.986	B	M	4	8	B200E, B200G		81594
	89	08/85 → 07/92	1.986	B	M	4	8	B200G		81594
	118	01/86 → 08/90	1.986	B	M	4	8	B200ET		81594
2.0 GLE	103	09/87 → 08/90	1.986	B	M	4	16	B204E		81594
2.0 Turbo	114	09/90 → 08/91	1.986	B	M	4	8	B200FT		81594
	115	09/87 → 08/90	1.986	B	M	4	8	B200ET		81594

**KW**

**cm<sup>3</sup>**

**NO. OF VALVES**

**VOLVO**
**740, Station Wagon**

2.3	84	08/84 → 07/90	2.316	B	M	4	8	B230F, B23A	81592
	84	09/85 → 07/90	2.316	B	M	4	8	B230K	81594
	85	08/87 → 07/92	2.316	B	M	4	8	B230F	81594
	100	08/88 → 07/90	2.316	B	M	4	8	B230FB	81594
	111	08/88 → 08/92	2.316	B	M	4	16	B234F	81594
	114	08/88 → 07/91	2.316	B	M	4	16	B234F	81594
2.3 Turbo	121	08/89 → 07/90	2.316	B	M	4	8	B230FT	81594
	121	08/89 → 07/90	2.316	B	M	4	8	B230FT, B230GT	81594
	125	09/89 → 08/91	2.316	B	M	4	8	B230FT, B230GT	81594
	140	08/89 → 07/90	2.316	B	M	4	8	B230FT	81594
2.4 Diesel	60	08/84 → 07/92	2.383	D	M	6	12	D24	81593
2.4 TD	80	08/85 → 12/90	2.383	D	M	6	12	D24T	81593
	83	08/84 → 07/90	2.383	D	M	6	12	D24T	81593
2.4 Turbo-Diesel	80	09/85 → 07/92	2.383	D	M	6	12	D24T	81593

**760, Station Wagon**

2.3	121	01/88 → 07/92	2.316	B	M	4	8	B230FT	81594
2.3 Turbo	115	09/87 → 08/90	2.316	B	M	4	8	B230FT	81594
	134	08/84 → 08/90	2.316	B	M	4	8	B230ET	81594
2.4 D	60	01/82 → 07/92	2.383	D	M	6	12	D24	81593
2.4 TD Interc.	85	08/87 → 07/92	2.383	D	M	6	12	D24TIC	81593
2.4 Turbo Diesel	80	04/87 → 07/92	2.383	D	M	6	12	D24T	81593

**850, Station Wagon**

2.0	93	08/94 → 12/96	1.984	B	M	5	10	B5202S	82056
	105	06/91 → 12/96	1.984	B	M	5	20	B5204F	82056
2.0 Turbo	132	09/93 → 10/96	1.984	B	M	5	20	B5204T2	82056
	155	08/93 → 12/96	1.984	B	M	5	20	B5204FT, B5204T	82056
2.3	106	01/96 → 10/96	2.319	B	M	5	20	B5234FS	82056
2.3 T5	166	08/93 → 07/96	2.319	B	M	5	20	B5234FT	82056
2.3 T5 R	176	04/96 → 10/96	2.319	B	M	5	20	B5234T2	82056
	184	08/95 → 12/96	2.319	B	M	5	20	B5234T4	82056
2.3 Turbo R	177	06/95 → 10/96	2.319	B	M	5	20	B5234T5	82056
2.4 GLE	142	09/93 → 10/97	2.435	B	M	5	20	B5254T	82056
2.5	103	06/91 → 07/94	2.435	B	M	5	10	B5252	82056
	106	08/94 → 12/96	2.435	B	M	5	10	B5252FS	82056
	125	08/91 → 12/96	2.435	B	M	5	20	B5254S	82056
2.5 AWD	142	04/96 → 12/96	2.435	B	M	5	20	B5254T	82056
2.5 TDI	103	08/95 → 12/96	2.461	D	M	5	10	D5252T	81701

**940 I, Station Wagon**

2.0	82	01/92 → 07/94	1.986	B	M	4	8	B200F	81594
	89	09/90 → 09/93	1.986	B	M	4	8	B200E, B200G	81594
	89	09/90 → 09/93	1.986	B	M	4	8	B200G	81594
	102	09/90 → 09/93	1.986	B	M	4	16	B204FT	81594
2.0 Turbo	114	08/90 → 12/94	1.986	B	M	4	8	B200FT	81594

**KW**

**cm<sup>3</sup>**

**NO. OF VALVES**

**MAGNETI MARELLI**
**VOLVO**
**940 I, Station Wagon**

2.3	85	08/92 → 07/94	2.316	B	M	4	8	B230FD		81594
	96	08/90 → 12/94	2.316	B	M	4	8	B230FB		81594
	96	08/90 → 12/94	2.316	B	M	4	8	B230FB, B230G		81594
	114	08/90 → 07/91	2.316	B	M	4	16	B234F		81594
	114	08/90 → 07/91	2.316	B	M	4	16	B234F, B234G		81594
2.3 Turbo	121	08/90 → 07/94	2.316	B	M	4	8	B230FT		81594
	140	08/91 → 07/93	2.316	B	M	4	8	B230FT+		81594
2.4 D	60	08/90 → 12/94	2.383	D	M	6	12	D24		81593
2.4 TD Intercooler	90	08/90 → 12/94	2.383	D	M	6	12	D24TIC	→ 06-1992, → T: 30.003	81593
	90	08/90 → 12/94	2.383	D	M	6	12	D24TIC	07-1992 →, T →: 30.004	81701
2.4 Turbo Diesel	80	08/90 → 12/94	2.383	D	M	6	12	D24T		81593

**940 II, Station Wagon**

2.0	89	11/94 → 12/95	1.986	B	M	4	8	B200G		81594
	102	10/94 → 05/97	1.986	B	M	4	16	B204FT		81594
2.0 Turbo	114	04/96 → 10/98	1.986	B	M	4	8	B200FT		81594
2.3	85	08/94 → 07/95	2.316	B	M	4	8	B230FD		81594
	96	08/94 → 10/98	2.316	B	M	4	8	B230FB		81594
2.3 ti	99	01/95 → 10/98	2.316	B	M	4	8	B230FK		81594
2.3 Turbo	121	08/94 → 10/98	2.316	B	M	4	8	B230FT		81594
	126	08/95 → 10/98	2.316	B	M	4	8	B230FT		81594
2.4 TD Interc.	90	08/94 → 10/98	2.383	D	M	6	12	D24TIC		81701

**960 I, Station Wagon**

2.0	103	09/90 → 08/93	1.986	B	M	4	16	B204E		81594
	140	08/90 → 09/93	1.986	B	M	4	16	B204FT		81594
2.3 Turbo	121	09/90 → 08/93	2.316	B	M	4	8	B230FT		81594
2.4 TD Interc.	85	09/91 → 07/94	2.383	D	M	6	12	D24TIC	→ 06-1992, → T: 30.003	81593
	85	09/91 → 07/94	2.383	D	M	6	12	D24TIC	07-1992 →, T →: 30.004	81701
2.9	150	08/90 → 07/94	2.922	B	M	6	24	B6304F, B6304FS, B6304G		81857
	150	08/90 → 07/94	2.922	B	M	6	24	B6304F, B6304S		81857

**960 II, Station Wagon**

2.5	125	07/94 → 12/96	2.473	B	M	6	24	B6254S		81857
	125	08/94 → 12/96	2.473	B	M	6	24	B6254S	07-1994 →, → 10-1996	81857
2.9	150	07/94 → 12/96	2.922	B	M	6	24	B6304S		81857

**C 30**

1.6	74	10/06 → 12/12	1.596	B	M	4	16	B4164S3		81598
1.6 D	80	10/06 → 12/12	1.560	D	M	4	16	D4164T		81869
1.6 D2	84	10/10 → 12/12	1.560	D	M	4	8	D4162T		81869
1.8	92	10/06 → 12/12	1.798	B	M	4	16	B4184S11		81804

**KW**

**cm<sup>3</sup>**

**NO. OF VALVES**

**MAGNETI MARELLI**
**VOLVO**

<b>C 30</b>										
1.8 FlexFuel	92	01/07 → 12/12	1.798		M	4	16	B4184S8		81804
2.0	107	10/06 → 12/12	1.999	B	M	4	16	B4204S3		81804
2.0 D	100	10/06 → 12/12	1.998	D	M	4	16	D4204T		81800
2.0 FlexFuel	107	01/10 → 12/12	1.999		M	4	16	B4204S4		81804
2.4 i	125	10/06 → 12/12	2.435	B	M	5	20	B5244S4		82056
D3	110	10/10 → 12/12	1.984	D	M	5	20	D5204T5		81864
D4	130	10/10 → 12/12	1.984	D	M	5	20	D5204T		81864
D5	120	10/06 → 12/12	2.400	D	M	5	20	D5244T9		81864
	132	10/06 → 12/12	2.400	D	M	5	20	D5244T13, D5244T8		81864
T5	162	10/06 → 12/12	2.521	B	M	5	20	B5254T3		82056
	169	03/07 → 12/12	2.521	B	M	5	20	B5254T7		82056
<b>C 70 I, Cabrio, Coupé</b>										
2.0	132	03/98 → 10/05	1.984	B	M	5	20	B5204T2		82056
2.0 T	120	03/00 → 10/05	1.984	B	M	5	20	B5204T4		82056
	166	03/98 → 10/05	1.984	B	M	5	20	B5204T3		82056
2.3 T5	176	03/98 → 10/05	2.319	B	M	5	20	B5234T3		82056
	180	07/02 → 10/05	2.319	B	M	5	20	B5234T9		82056
2.3 T-5	176	03/97 → 09/02	2.319	B	M	5	20	B5234T3		82056
2.4 T	147	07/02 → 10/05	2.435	B	M	5	20	B5244T7		82056
2.5	121	03/99 → 09/02	2.435	B	M	5	20	B5254S		82056
	125	05/99 → 09/02	2.435	B	M	5	20	B5244S, B5254S		82056
	125	06/98 → 10/05	2.435	B	M	5	20	B5254S		82056
2.5 T	142	03/98 → 10/05	2.435	B	M	5	20	B5244T, B5254T		82056
<b>C 70 II</b>										
2.0 D	100	01/08 → 10/09	1.997	D	M	4	16	D4204T		81800
2.4	103	03/06 → 10/09	2.435	B	M	5	20	B5244S5		82056
2.4 D	120	03/07 → 06/13	2.400	D	M	5	20	D5244T9		81864
2.4 i	125	03/06 → 10/09	2.435	B	M	5	20	B5244S4		82056
D3	110	10/10 → 06/13	1.984	D	M	5	20	D5204T5		81864
D4	130	10/10 → 06/13	1.984	D	M	5	20	D5204T		81864
D5	132	03/06 → 06/13	2.400	D	M	5	20	D5244T13, D5244T8		81864
T5	162	03/06 → 02/07	2.521	B	M	5	20	B5254T3		82056
	169	03/07 → 10/09	2.521	B	M	5	20	B5254T7		82056
<b>S 40 I</b>										
1.6	80	03/99 → 12/03	1.587	B	M	4	16	B4164S2		82056
	77	09/95 → 08/99	1.588	B	M	4	16	B4164S		82056
1.8	85	07/95 → 08/99	1.731	B	M	4	16	B4184S, B4184S3		82056
	85	06/01 → 08/03	1.783		M	4	16	B4184S2		82056
	90	03/99 → 12/03	1.783	B	M	4	16	B4184S2, B4184S9		82056
1.8 i	90	06/01 → 12/03	1.834	B	M	4	16	B4184SJ		82056

		<b>KW</b>		<b>cm<sup>3</sup></b>				<b>NO. OF VALVES</b>		
--	--	-----------	--	-----------------------	--	--	--	----------------------	--	--

**VOLVO**
**S 40 I**

1.9 DI	70	03/99 → 07/00	1.870	D	M	4	8	D4192T2		81574
	75	07/00 → 12/03	1.870	D	M	4	8	D4192T4		81814
	75	07/00 → 12/03	1.870	D	M	4	8	D4192T4		84009
	85	07/00 → 12/03	1.870	D	M	4	8	D4192T3		81814
	85	07/00 → 12/03	1.870	D	M	4	8	D4192T3		84009
1.9 T4	147	05/97 → 07/00	1.855	B	M	4	16	B4194T, B4194T2		82056
1.9 TD	66	07/95 → 08/99	1.870	D	M	4	8	D4192T	01-1997 →	81574
2.0	100	07/95 → 12/03	1.948	B	M	4	16	B4204S, B4204S2	11-1995 →	82056
	100	07/95 → 12/03	1.948	B	M	4	16	B4204S, B4204S2		82056
	103	07/95 → 08/99	1.948	B	M	4	16	B4204S	11-1995 →	82056
	103	07/95 → 08/99	1.948	B	M	4	16	B4204S		82056
2.0 T	118	10/97 → 12/03	1.948	B	M	4	16	B4204T		82056
	120	06/01 → 12/03	1.948	B	M	4	16	B4204T3		82056
	121	07/00 → 06/01	1.948	B	M	4	16	B4204T2, B4204T3		82056
2.0 T4	147	07/00 → 12/03	1.948	B	M	4	16	B4204T5		82056

**S 40 II**

1.6	74	01/05 →	1.596	B	M	4	16	B4164S3		82056
1.6 D	81	01/05 →	1.560	D	M	4	16	D4164T		81869
1.6 D2	84	10/10 →	1.560	D	M	4	8	D4162T		81869
1.8	92	04/04 →	1.798	B	M	4	16	B4184S11		82056
1.8 FlexFuel	92	01/06 →	1.798		M	4	16	B4184S8		82056
2.0	107	10/06 →	1.999	B	M	4	16	B4204S3		81804
2.0 D	100	01/04 →	1.998	D	M	4	16	D4204T		81800
2.0 D4	96	07/05 →	1.998	D	M	4	16	D4204T2		81800
2.0 F	107	10/09 →	1.999	FF	M	4	16	B4204S4		81804
2.4	103	01/04 →	2.435	B	M	5	20	B5244S5		82056
	125	01/04 →	2.435	B	M	5	20	B5244S4		82056
2.4 AWD	125	08/06 →	2.435	B	M	5	20	B5244S4		82056
2.4 D5	132	03/06 →	2.400	D	M	5	20	D5244T13, D5244T8		81864
D3	110	10/10 →	1.984	D	M	5	20	D5204T5		81864
D4	130	10/10 →	1.984	D	M	5	20	D5204T		81864
T5	162	01/04 →	2.521	B	M	5	20	B5254T3		82056
	169	03/07 →	2.521	B	M	5	20	B5254T7		82056
T5 AWD	162	04/04 →	2.521	B	M	5	20	B5254T3		82056
	169	03/07 →	2.521	B	M	5	20	B5254T7		82056

**S 60 I**

2.0 T	132	07/00 → 04/10	1.984	B	M	5	20	B5204T5		82056
2.3 T5	195	07/00 → 09/02	2.319	B	M	5	20	B5234T7		82056
2.4	103	11/00 → 04/10	2.435	B	AM	5	20	B5244S2		82056
	125	11/00 → 04/10	2.435	B	AM	5	20	B5244S		82056
2.4 AWD	191	02/04 → 04/10	2.401	B	M	5	20	B5244T5		82056
2.4 Bifuel	103	06/02 → 04/10	2.435	BF	M	5	20	B5244SG		82056
	103	06/02 → 04/10	2.435	BF	M	5	20	B5244SG2		82056

**KW**

**cm<sup>3</sup>**

**NO. OF VALVES**

**MAGNETI MARELLI**
**VOLVO**
**S 60 I**

2.4 D	93	09/05 → 04/10	2.400	D	M	5	20	D5244T7	81864
	120	09/05 → 01/09	2.400	D	M	5	20	D5244T5	81864
	96	12/01 → 04/10	2.401	D	M	5	20	D5244T2	81864
2.4 D5	120	07/01 → 04/10	2.401	D	M	5	20	D5244T	81864
	136	09/05 → 04/10	2.401	D	M	5	20	D5244T4	81864
2.4 T	147	11/00 → 04/10	2.435	B	M	5	20	B5244T3	82056
2.4 T AWD	147	11/01 → 04/10	2.435	B	M	5	20	B5244T3	82056
2.4 T5	191	04/04 → 04/10	2.401	B	M	5	20	B5244T5	82056
2.5 T	154	02/04 → 04/10	2.521	B	M	5	20	B5254T2	82056
2.5 T AWD	154	04/04 → 04/10	2.521	B	M	5	20	B5254T2	82056
R 2,5 T AWD	221	03/03 → 04/10	2.521	B	M	5	20	B5254T4	82056
T5	184	11/00 → 04/10	2.319	B	AM	5	20	B5234T3	82056

**S 60 II**

2.0 T	132	12/13 →	1.984	B	M	5	20	B5204T8	82056
	149	04/10 →	1.999	B	M	4	16	B4204T6	81804
2.4 D4 AWD	140	03/15 →	2.400	D	M	5	20	D5244T21	81864
2.5 T5	186	09/11 →	2.521	B	M	5	20	B5254T5	82056
2.5 T5 AWD	186	09/12 →	2.521	B	M	5	20	B5254T5	82056
D3	100	05/12 →	1.984	D	M	5	20	D5204T7	81864
	120	04/10 → 04/12	1.984	D	M	5	20	D5204T2, D5204T3	81864
D4	120	05/12 →	1.984	D	M	5	20	D5204T3	81864
D5	151	04/10 →	2.400	D	M	5	20	D5244T10	81864
	158	06/11 →	2.400	D	M	5	20	D5244T11, D5244T15	81864
	169	04/14 →	2.400	D	M	5	20	D5244T15, D5244T23	81864
D5 AWD	151	04/10 →	2.400	D	M	5	20	D5244T10	81864
	158	06/11 →	2.400	D	M	5	20	D5244T15	81864
	169	04/14 →	2.400	D	M	5	20	D5244T15, D5244T23	81864
DRIVE / D2	84	01/11 →	1.560	D	M	4	8	D4162T	81869
T3	110	04/10 →	1.596	B	M	4	16	B4164T3	82027
T4	132	04/10 →	1.596	B	M	4	16	B4164T	82027
T4F	132	04/11 →	1.596	FF	M	4	16	B4164T2	82027
T5	177	04/10 →	1.999	B	M	4	16	B4204T7	81804
T6 AWD	224	04/10 →	2.953	B	M	6	24	B6304T4	81804

**S 70**

2.0	93	01/97 → 11/00	1.984	B	M	5	10	B5202FS, B5202S	82056
	105	01/97 → 11/00	1.984	B	M	5	20	B5204F	82056
	120	01/97 → 11/00	1.984	B	M	5	20	B5204T4	82056
	132	01/97 → 11/00	1.984	B	M	5	20	B5204T2	82056
2.0 Turbo	155	01/97 → 11/00	1.984	B	M	5	20	B5204T	82056
	166	01/97 → 11/00	1.984	B	M	5	20	B5204T3	82056
2.3	195	04/99 → 09/00	2.319	B	M	5	20	B5234T7	82056
2.3 T-5	176	01/97 → 11/00	2.319	B	M	5	20	B5234T3	82056
2.3 T5 AWD	177	11/96 → 09/98	2.319	B	M	5	20	B5234T3	82056
	184	07/97 → 09/00	2.319	B	M	5	20	B5234T4	82056



		<b>KW</b>		<b>cm<sup>3</sup></b>				<b>NO. OF VALVES</b>		
--	--	-----------	--	-----------------------	--	--	--	----------------------	--	--

## VOLVO

### S 70

2.3 Turbo	184	01/97 → 11/00	2.319	B	M	5	20	B5234FT+		82056
2.4	103	08/99 → 11/00	2.435	B	M	5	20	B5244S2, B5244SG		82056
	125	01/97 → 11/00	2.435	B	M	5	20	B5244S, B5254S		82056
2.4 AWD	103	04/99 → 09/00	2.435	B	M	5	20	B5244S2		82056
	106	11/96 → 05/99	2.435	B	M	5	10	B5252FS		82056
	121	10/98 → 05/99	2.435	B	M	5	20	B5254S		82056
	125	04/99 → 09/00	2.435	B	M	5	20	B5244S		82056
2.4 Blu-Fuel	103	07/97 → 09/00	2.435	G	M	5	20	B5244S2, B5244SG		82056
2.4 T5 AWD	142	11/96 → 04/99	2.435	B	M	5	20	B5254T		82056
2.4 Turbo	142	01/97 → 11/00	2.435	B	M	5	20	B5244T, B5254T		82056
2.5	106	01/97 → 11/00	2.435	B	M	5	10	B5252FS		82056
	121	06/98 → 11/00	2.435	B	M	5	20	B5254S		82056
2.5 Bifuel	103	07/99 → 11/00	2.435	BF	A	5	20	B5244SG		82056
	106	10/98 → 11/00	2.435	BF	M	5	10	GB5252S		82056
2.5 TDI	103	01/97 → 11/00	2.461	D	M	5	10	D5252T		81701

### S 80 I

2.0	120	06/98 → 07/06	1.984	B	M	5	20	B5204T4		82056
2.0 T	132	12/99 → 07/06	1.984	B	M	5	20	B5204T5		82056
	166	06/98 → 07/06	1.984	B	M	5	20	B5204T3		82056
2.4	103	01/99 → 07/06	2.435	B	M	5	20	B5244S2		82056
	125	01/99 → 07/06	2.435	B	M	5	20	B5244S		82056
2.4 Bifuel	103	09/01 → 07/06	2.435	BF	M	5	20	B5244SG		82056
	103	09/01 → 07/06	2.435	BF	M	5	20	B5244SG2		82056
2.4 D	96	10/01 → 07/06	2.401	D	M	5	20	D5244T2		81864
2.4 D5	120	08/01 → 07/06	2.401	D	M	5	20	D5244T		81864
2.4 LTP	132	06/04 → 07/06	2.435	B	M	5	20	B5244T4		82056
2.4 T	147	06/00 → 07/06	2.435	B	M	5	20	B5244T3		82056
2.4 T5 AWD	147	04/00 → 09/03	2.435	B	M	5	20	B5244T3		82056
2.5 T	154	03/03 → 07/06	2.521	B	M	5	20	B5254T2		82056
2.5 T AWD	154	07/03 → 07/06	2.521	B	M	5	20	B5254T2		82056
2.5 TDI	103	01/99 → 07/06	2.461	D	M	5	10	D5252T	→ 12-2002	81701
2.8 T6	200	05/98 → 07/06	2.783	B	M	6	24	B6284T	→ 12-2002	81779
	200	05/98 → 07/06	2.783	B	M	6	24	B6284T	01-2003 →	81864
2.9	147	03/99 → 07/06	2.922	B	M	6	24	B6294S	→ 12-2002	81779
	147	03/99 → 07/06	2.922	B	M	6	24	B6294S	01-2003 →	81864
	150	05/98 → 07/06	2.922	B	M	6	24	B6304S3	→ 12-2002	81779
	150	05/98 → 07/06	2.922	B	M	6	24	B6304S3	01-2003 →	81864
3.0	144	06/01 → 07/06	2.922	B	M	6	24	B6294S2	→ 12-2002	81779
	144	06/01 → 07/06	2.922	B	M	6	24	B6294S2	01-2003 →	81864
3.0 T6	200	06/01 → 07/06	2.922	B	M	6	24	B6294T	→ 12-2002	81779
	200	06/01 → 07/06	2.922	B	M	6	24	B6294T	01-2003 →	81864

**KW**

**cm<sup>3</sup>**

**NO. OF VALVES**

**VOLVO**
**S 80 II**

1.6 D DRiVe	80	01/10 →	1.560	D	M	4	16	D4164T		81869
1.6 DRiVe	84	06/11 →	1.560	D	M	4	8	D4162T		81869
2.0	107	01/08 →	1.999	B	M	4	16	B4204S3		81804
2.0 FlexFuel	107	01/08 →	1.999		M	4	16	B4204S4		81804
2.0 T	149	01/10 →	1.999	B	M	4	16	B4204T6		81804
2.0 TDi	100	02/08 →	1.997	D	M	4	16	D4204T		81800
2.4 D	120	03/06 →	2.400	D	M	5	20	D5244T, D5244T5		81864
	129	01/10 →	2.400	D	M	5	20	D5244T14		81864
2.5 T	183	09/12 →	2.497	B	M	5	20	B5254T14		82056
	187	01/12 →	2.497	B	M	5	20	B5254T12		82056
	147	03/06 →	2.521	B	M	5	20	B5254T6		82056
	170	01/10 →	2.521	B	M	5	20	B5254T10		82056
2.5 T AWD	147	10/06 →	2.521	B	M	5	20	B5254T6		82056
2.5 T FlexFuel	147	05/08 →	2.521		M	5	20	B5254T8		82056
	170	01/10 →	2.521		M	5	20	B5254T11		82056
D3	100	05/12 →	1.984	D	M	5	20	D5204T7		81864
D3 / D4	120	01/10 →	1.984	D	M	5	20	D5204T2, D5204T3		81864
D5	136	03/06 →	2.400	D	M	5	20	D5244T4		81864
	151	01/10 →	2.400	D	M	5	20	D5244T10		81864
	158	06/11 →	2.400	D	M	5	20	D5244T11, D5244T15		81864
D5 AWD	136	01/07 →	2.400	D	M	5	20	D5244T4		81864
	151	01/10 →	2.400	D	M	5	20	D5244T10		81864
	158	06/11 →	2.400	D	M	5	20	D5244T15		81864
T4	132	10/10 →	1.596	B	M	4	16	B4164T		82027
T4F	132	05/11 →	1.596	FF	M	4	16	B4164T2		82027
T5	177	10/10 →	1.999	B	M	4	16	B4204T7		81804

**S 90**

2.5	125	11/96 → 10/98	2.473	B	M	6	24	B6254FS		81857
	132	11/96 → 10/97	2.473	B	M	6	24	B6244FS		81857
2.9	132	01/97 → 05/98	2.922	B	M	6	24	B6304S2	11-1996 →	81857
	150	01/97 → 05/98	2.922	B	M	6	24	B6304G		81857

**V 40 I**

1.6	80	03/99 → 06/04	1.587	B	M	4	16	B4164S2		82056
	77	12/95 → 08/99	1.588	B	M	4	16	B4164S		82056
1.8	85	07/95 → 08/99	1.731	B	M	4	16	B4184S, B4184S3		82056
	90	03/99 → 06/04	1.783	B	M	4	16	B4184S2, B4184S9		82056
1.8 i	90	06/01 → 06/04	1.834	B	M	4	16	B4184SJ		82056
1.9 DI	70	03/99 → 07/00	1.870	D	M	4	8	D4192T2		81574
	75	07/00 → 06/04	1.870	D	M	4	8	D4192T4		81814
	75	07/00 → 06/04	1.870	D	M	4	8	D4192T4		84009
	85	07/00 → 06/04	1.870	D	M	4	8	D4192T3		81814
	85	07/00 → 06/04	1.870	D	M	4	8	D4192T3		84009
1.9 T4	147	05/97 → 07/00	1.855	B	M	4	16	B4194T		82056
1.9 TD	66	07/95 → 08/99	1.870	D	M	4	8	D4192T		81574

**KW**

**cm<sup>3</sup>**

**NO. OF VALVES**

**MAGNETI MARELLI**
**VOLVO**
**V 40 I**

2.0	100	07/95 → 06/04	1.948	B	M	4	16	B4204S, B4204S2		82056
	103	07/95 → 08/99	1.948	B	M	4	16	B4204S		82056
2.0 T	118	10/97 → 07/00	1.948	B	M	4	16	B4204T		82056
	120	06/01 → 06/04	1.948	B	M	4	16	B4204T3		82056
	121	07/99 → 06/04	1.948	B	M	4	16	B4204T2		82056
2.0 T4	147	07/00 → 06/04	1.948	B	M	4	16	B4204T5		82056

**V 40 II**

D2	84	03/12 →	1.560	D	M	4	8	D4162T		81869
D3	110	03/12 → 03/15	1.984	D	M	5	20	D5204T6		81864
D4	130	03/12 →	1.984	D	M	5	20	D5204T4		81864
T2 GTDi	88	03/13 →	1.596	B	M	4	16	B4164T4		82027
	88	03/13 →	1.596	B	M	4	16	B4164T4		81598
T3 GTDi	110	03/12 →	1.596	B	M	4	16	B4164T3		82027
	110	03/12 →	1.596	B	M	4	16	B4164T3		81598
T4	147	04/14 →	1.596	B	M	4	16	B4164T		82027
	132	07/13 →	1.984	B	M	5	20	B5204T8		82056
T4 AWD	132	07/13 →	1.984	B	M	5	20	B5204T8		82056
T4 GTDi	132	03/12 →	1.596	B	M	4	16	B4164T		82027
	132	03/12 →	1.596	B	M	4	16	B4164T		81598
T5	157	03/13 →	1.984	B	M	5	20	B5204T9		82056
	183	01/14 →	2.497	B	M	5	20	B5254T14		82056
	187	12/12 →	2.497	B	M	5	20	B5254T12		82056
T5 AWD	157	03/13 →	1.984	B	M	5	20	B5204T9		82056
	187	01/13 →	2.497	B	M	5	20	B5254T12		82056

**V 50**

1.6	74	01/05 →	1.596	B	M	4	16	B4164S3		81598
1.6 D	81	01/05 →	1.560	D	M	4	16	D4164T		81869
1.6 D2	84	01/10 →	1.560	D	M	4	8	D4162T		81869
1.8	92	04/04 →	1.798	B	M	4	16	B4184S11		81804
1.8 FlexFuel	92	01/05 →	1.798		M	4	16	B4184S8		81804
2.0	107	10/06 →	1.999	B	M	4	16	B4204S3		81804
2.0 D	100	04/04 →	1.998	D	M	4	16	D4204T		81800
2.0 FlexFuel	107	01/10 →	1.999		M	4	16	B4204S4		81804
2.4	103	04/04 →	2.435	B	M	5	20	B5244S5		82056
	125	04/04 →	2.435	B	M	5	20	B5244S4		82056
2.4 AWD	125	08/06 →	2.435	B	M	5	20	B5244S4		82056
2.4 D5	132	03/06 →	2.400	D	M	5	20	D5244T13, D5244T8		81864
2.4 Tdi	120	05/07 →	2.400	D	M	5	20	D5244T9		81864
D3	110	10/10 →	1.984	D	M	5	20	D5204T5		81864
D4	130	10/10 →	1.984	D	M	5	20	D5204T		81864
T5	162	04/04 →	2.521	B	M	5	20	B5254T3		82056
	169	03/07 →	2.521	B	M	5	20	B5254T7		82056
T5 AWD	162	04/04 →	2.521	B	M	5	20	B5254T3		82056
	169	03/07 →	2.521	B	M	5	20	B5254T7		82056

**KW**

**cm<sup>3</sup>**

**NO. OF VALVES**

**VOLVO**

<b>V 60</b>										
1.6 DRIVe	84	06/11 →	1.560	D	M	4	8	D4162T		81869
2.0 T	149	09/10 →	1.999	B	M	4	16	B4204T6		81804
2.4 D5	158	06/11 →	2.400	D	M	5	20	D5244T11, D5244T15		81864
2.4 D5 AWD	158	06/11 →	2.400	D	M	5	20	D5244T15		81864
2.4 D5 Hybrid AWD	120	03/15 →	2.400		M	5	20	D87PHEV		81864
2.4 Hybrid D6 AWD	158	06/12 →	2.400		M	5	20	D82PHEV		81864
D3	100	12/12 →	1.984	D	M	5	20	D5204T7		81864
D3 / D4	120	09/10 →	1.984	D	M	5	20	D5204T2, D5204T3		81864
D4 AWD	120	12/12 →	2.400	D	M	5	20	D5244T17		81864
	133	10/13 →	2.400	D	M	5	20	D5244T12		81864
	140	03/15 →	2.400	D	M	5	20	D5244T21		81864
D5	151	09/10 →	2.400	D	M	5	20	D5244T10		81864
	169	04/14 →	2.400	D	M	5	20	D5244T23		81864
D5 AWD	151	09/10 →	2.400	D	M	5	20	D5244T10		81864
	169	04/14 →	2.400	D	M	5	20	D5244T15, D5244T23		81864
D6 Hybrid AWD	162	03/15 →	2.400		M	5	20	D97PHEV		81864
T3	110	09/10 →	1.596	B	M	4	16	B4164T3		82027
T4	132	09/10 →	1.596	B	M	4	16	B4164T		82027
T4F	132	04/11 →	1.596	FF	M	4	16	B4164T2		82027
T5	157	04/14 →	1.984	B	M	5	20	B5204T9		82056
	177	09/10 →	1.999	B	M	4	16	B4204T7		81804
<b>V 70 I</b>										
2.0	93	01/97 → 03/00	1.984	B	M	5	10	B5202S		82056
	105	01/97 → 03/00	1.984	B	M	5	20	B5204F	11-1996 →	82056
	105	01/97 → 03/00	1.984	B	M	5	20	B5204F		82056
	120	01/97 → 03/00	1.984	B	M	5	20	B5204T4		82056
	132	01/97 → 03/00	1.984	B	M	5	20	B5204T2		82056
2.0 Turbo	155	01/97 → 03/00	1.984	B	M	5	20	B5204T		82056
	166	01/97 → 03/00	1.984	B	M	5	20	B5204T3		82056
2.0 Turbo AWD	166	01/97 → 03/00	1.984	B	M	5	20	B5204T3		82056
2.3	177	11/96 → 11/00	2.319	B	M	5	20	B5234T3		82056
2.3 AWD	177	04/97 → 09/98	2.319	B	M	5	20	B5234T3		82056
	195	12/98 → 02/00	2.319	B	M	5	20	B5234T7, B5234T8		82056
2.3 T AWD	184	04/97 → 03/00	2.319	B	M	5	20	B5234FT+, B5234T4		82056
2.3 T-5	176	01/97 → 03/00	2.319	B	M	5	20	B5234T3		82056
2.3 T-5 AWD	176	01/97 → 03/00	2.319	B	M	5	20	B5234T3		82056
2.3 Turbo	184	01/97 → 03/00	2.319	B	M	5	20	B5234FT+		82056
2.4	103	08/99 → 05/00	2.435	B	M	5	20	B5244S2, B5244SG2		82056
	125	01/97 → 05/00	2.435	B	M	5	20	B5244S, B5254S		82056
2.4 AWD	121	10/98 → 05/99	2.435	B	M	5	20	B5254S		82056
2.4 Bifuel	103	08/99 → 03/00	2.435	BF	M	5	20	B5244SG		82056
2.4 Turbo	142	01/97 → 03/00	2.435	B	M	5	20	B5244T, B5254T		82056
2.5	106	01/97 → 03/00	2.435	B	M	5	10	B5252FS		82056
	121	06/98 → 03/00	2.435	B	M	5	20	B5254S		82056

--	--	--	--	--	--	--	--	--	--

## VOLVO

### V 70 I

2.5 AWD	195	03/99 → 03/00	2.435	B	M	5	20	B5244T2	82056
2.5 Bifuel	106	10/98 → 08/99	2.435	BF	M	5	10	GB5252S	82056
2.5 TDI	103	01/97 → 05/00	2.461	D	M	5	10	D5252T	81701
2.5 Turbo AWD	142	01/97 → 05/00	2.435	B	M	5	20	B5244T, B5254T	82056

### V 70 II

2.0 T	132	07/01 → 08/07	1.984	B	M	5	20	B5204T5	82056
2.3	195	10/00 → 09/04	2.319	B	M	5	20	B5234T7	82056
2.3 AWD	195	10/00 → 09/04	2.319	B	M	5	20	B5234T7, B5234T8	82056
2.3 T5	184	03/00 → 08/04	2.319	B	M	5	20	B5234T3, B5234T4	82056
2.4	103	03/00 → 08/07	2.435	B	M	5	20	B5244S2	82056
	121	03/00 → 09/03	2.435	B	M	5	20	B5254S	82056
	125	03/00 → 08/07	2.435	B	M	5	20	B5244S	82056
2.4 Bifuel	103	09/01 → 08/07	2.435	BF	M	5	20	B5244SG, B5244SG2	82056
	103	09/01 → 08/07	2.435	BF	M	5	20	B5244SG2	82056
2.4 D	93	05/05 → 08/07	2.400	D	M	5	20	D5244T7	81864
	96	12/01 → 08/07	2.401	D	M	5	20	D5244T2	81864
2.4 D5	120	08/01 → 08/07	2.401	D	M	5	20	D5244T, D5244T5	81864
	136	12/05 → 08/07	2.401	D	M	5	20	D5244T4	81864
2.4 D5 AWD	120	03/03 → 08/07	2.401	D	M	5	20	D5244T, D5244T2, D5244T5	81864
	136	12/05 → 08/07	2.401	D	M	5	20	D5244T4	81864
2.4 T	147	03/00 → 08/03	2.435	B	M	5	20	B5244T3	82056
2.4 T AWD	147	09/01 → 08/02	2.435	B	M	5	20	B5244T3	82056
2.4 T5	191	04/04 → 08/07	2.401	B	M	5	20	B5244T5	82056
2.5 R Sport	221	12/02 → 08/07	2.521	B	M	5	20	B5254T4	82056
2.5 T	154	04/04 → 08/07	2.521	B	M	5	20	B5254T2	82056
2.5 T AWD	154	09/02 → 08/07	2.521	B	M	5	20	B5254T2	82056
R 2,5 T AWD	221	03/03 → 08/07	2.521	B	M	5	20	B5254T4	82056

### V 70 III

1.6 D	80	01/10 →	1.560	D	M	4	16	D4164T	81869
1.6 DRIVE / D2	84	06/11 →	1.560	D	M	4	8	D4162T	81869
1.6 T4F	132	01/11 →	1.596	FF	M	4	16	B4164T2	82027
2.0	107	10/07 →	1.999	B	M	4	16	B4204S3	81804
2.0 BiFuel	157	03/13 →	1.984	BF	M	5	20	B5204T9	82056
2.0 D	100	10/07 →	1.997	D	M	4	16	D4204T	81800
2.0 FlexiFuel	107	01/08 →	1.999		M	4	16	B4204S4	81804
2.0 T	149	01/10 →	1.999	B	M	4	16	B4204T6	81804
2.4 D	120	08/07 →	2.400	D	M	5	20	D5244T5	81864
	129	10/09 →	2.400	D	M	5	20	D5244T14	81864
2.5 T	147	08/07 →	2.521	B	M	5	20	B5254T6	82056
	170	01/10 →	2.521	B	M	5	20	B5254T10	82056
2.5 T FlexiFuel	147	05/08 →	2.521		M	5	20	B5254T8	82056
	170	10/09 →	2.521		M	5	20	B5254T11	82056
D3	100	03/10 →	1.984	D	M	5	20	D5204T7	81864

**KW**

**cm<sup>3</sup>**

**NO. OF VALVES**

**VOLVO**
**V 70 III**

D3 / D4	120	03/10 →	1.984	D	M	5	20	D5204T2, D5204T3	81864
D4 AWD	120	01/13 →	2.400	D	M	5	20	D5244T17	81864
	133	10/13 →	2.400	D	M	5	20	D5244T12	81864
D5	136	08/07 →	2.400	D	M	5	20	D5244T4	81864
	151	12/09 →	2.400	D	M	5	20	D5244T10	81864
	158	06/11 →	2.400	D	M	5	20	D5244T11, D5244T15	81864
D5 AWD	136	10/07 →	2.400	D	M	5	20	D5244T4	81864
	151	12/09 →	2.400	D	M	5	20	D5244T10	81864
	158	06/11 →	2.400	D	M	5	20	D5244T11, D5244T15	81864
T4	132	10/10 →	1.596	B	M	4	16	B4164T	82027
T5	177	01/10 →	1.999	B	M	4	16	B4204T7	81804

**V 90**

2.5	125	11/96 → 10/98	2.473	B	M	6	24	B6254FS	81857
	132	11/96 → 10/97	2.473	B	M	6	24	B6244FS	81857
2.9	132	01/97 → 12/98	2.922	B	M	6	24	B6304S2	81857
	150	01/97 → 12/98	2.922	B	M	6	24	B6304G	81857

**XC 60**

2.0 T	149	03/10 →	1.999	B	M	4	16	B4204T6	81804
2.4 D	129	07/09 →	2.400	D	M	5	20	D5244T14	81864
2.4 D / D3 / D4 AWD	120	05/08 →	2.400	D	M	5	20	D5244T16, D5244T17, D5244T5	82056
D3	100	04/12 →	1.984	D	M	5	20	D5204T7	81864
D3 / D4	120	03/10 →	1.984	D	M	5	20	D5204T2, D5204T3	81864
D4 AWD	133	10/13 →	2.400	D	M	5	20	D5244T12	81864
	140	03/15 →	2.400	D	M	5	20	D5244T21	81864
D5	158	06/11 →	2.400	D	M	5	20	D5244T11, D5244T15	81864
D5 AWD	136	05/08 →	2.400	D	M	5	20	D5244T4	82056
	151	07/09 → 06/11	2.400	D	M	5	20	D5244T10	81864
	158	06/11 →	2.400	D	M	5	20	D5244T11, D5244T15	81864
	162	03/15 →	2.400	D	M	5	20	D5244T20, D5244T22	81864
	169	04/14 →	2.400	D	M	5	20	D5244T23	81864
T5	177	09/10 →	1.999	B	M	4	16	B4204T7	81804
T5 AWD	187	04/14 →	2.497	B	M	5	20	B5254T12	82056

**XC 70 I Cross Country**

2.4 D5 AWD	136	12/05 → 08/07	2.401	D	M	5	20	D5244T4	81864
2.4 D5 XC AWD	120	09/02 → 08/07	2.401	D	M	5	20	D5244T	81864
2.4 T XC AWD	142	11/97 → 09/02	2.435	B	M	5	20	B5254T	82056
	147	03/00 → 09/02	2.435	B	M	5	20	B5244T3	82056
	154	09/02 → 08/07	2.521	B	M	5	20	B5254T2	82056

**XC 70 II**

2.4 D	129	01/10 →	2.400	D	M	5	20	D5244T14	81864
2.4 D / D4 AWD	120	08/07 →	2.400	D	M	5	20	D5244T16, D5244T17, D5244T5	81864
D3	120	08/11 →	1.984	D	M	5	20	D5204T2, D5204T3	81864

--	--	--	--	--	--	--	--	--	--

## VOLVO

### XC 70 II

D3 AWD	120	08/11 →	1.984	D	M	5	20	D5204T2		81864
D4 AWD	133	10/13 →	2.400	D	M	5	20	D5244T12		81864
D5 AWD	136	08/07 →	2.400	D	M	5	20	D5244T4		81864
	151	12/09 →	2.400	D	M	5	20	D5244T10		81864
	158	06/11 →	2.400	D	M	5	20	D5244T11, D5244T15		81864
	162	03/15 →	2.400	D	M	5	20	D5244T20		81864
T5 AWD	187	08/15 →	2.497	B	M	5	20	B5254T12		82056

### XC 90 I

2.5 T	154	10/02 →	2.521	B	M	5	20	B5254T2		82056
D3 / D5	120	04/09 →	2.400	D	M	5	20	D5244T5		81864
D5	147	01/11 →	2.400	D	M	5	20	D5244T18		81864
	120	10/02 →	2.401	D	M	5	20	D5244T, D5244T5		81864
	136	05/06 →	2.401	D	M	5	20	D5244T4		81864
D5 AWD	120	10/07 →	2.400	D	M	5	20	D5244T5		81864
T6	200	10/02 →	2.922	B	M	6	24	B6294T		81864

## ZASTAVA

### 101

1.3	48	10/81 → 12/93	1.290	B	M	4	8	128AR.000	(-)COP	81481
-----	----	---------------	-------	---	---	---	---	-----------	--------	-------

### Yugo

60 EFI	44	08/91 → 06/95	1.116	B	M	4	8	100GL.0.64, 11E1.064	(-)COP	81481
	48	08/91 → 06/95	1.302	B	M	4	8	13E1.064	(-)COP	81481

### Yugo Florida

1.3	50	03/91 →	1.302	B	M	4	8	13E.3.064	(-)COP	81481
1.4	52	10/88 → 06/95	1.372	B	M	4	8	160A1.000	(-)COP	81481





**Applicazione per codice**  
**Buyers guide**  
**Zuordnung nach Bestellnummer**  
**Affectations par références**  
**Aplicación por referencia**  
**Aplicação por código**  
**Εφαρμογές ανά κωδικό**  
**Zastosowanie dla kodu**  
**Применение по коду**  
**Koda göre uygulama**

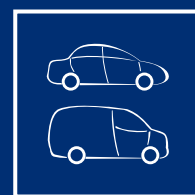



**11701T**
**351170120000**

FLANGIA	
Numero Fori Flangia	3
Dimensione Fori Flangia	M6×1
Posizione Attacco	100
Diametro Mozzo	Ø27
Diametro Centraggio	Ø28
Diametro Girante	Ø65.5
N° Alette Girante	5
Posizione Girante	2.5

**KW**

**ALFA ROMEO**
**75**

1.6	81	05/89 → 02/92	B	AR61101	
1.8	95	05/89 → 12/92	B	AR61202	
	95	08/89 → 02/92	B	AR67101	
	88	09/88 → 02/92	B	AR06168, AR61102	
	90	08/89 → 02/92	B	AR61201	
1.8 Turbo	110	09/86 → 02/92	B	AR06134	
1.8 Turbo i.e.	114	02/86 → 01/90	B	AR06134, AR06158	
2.0 T.S.	109	05/85 → 02/92	B	AR06224	
	107	01/87 → 02/92	B	AR06166, AR06224	

**Spider III**

1600	76	03/76 → 12/90	B	AR00526	→ 12-1985
	76	03/76 → 12/90	B	AR00526	01-1989 →
	79	01/90 → 12/93	B	AR01563	
2000	85	08/86 → 12/90	B	AR01544	01-1989 →
	88	01/90 → 12/93	B	AR01588	
	92	08/86 → 12/90	B	AR00515	01-1989 →
2000 Veloce	93	01/77 → 12/93	B	AR00515, AR01590	01-1978 →, → 12-1985
	93	01/77 → 12/93	B	AR00515, AR01590	01-1989 →

**11706T**
**351170620000**

FLANGIA	
Numero Fori Flangia	3
Dimensione Fori Flangia	M6×1
Posizione Attacco	63.5
Diametro Mozzo	Ø27
Diametro Centraggio	Ø28
Diametro Girante	Ø66
N° Alette Girante	7
Posizione Girante	41.3

**KW**

**ALFA ROMEO**
**33 I, Sportwagon**

1.5	70	05/83 → 12/93	B	AR30182	
-----	----	---------------	---	---------	--

**33 II, Sportwagon**

1.4 i.e.	65	06/91 → 09/94	B	AR30753, AR30755	
	66	06/91 → 09/94	B	AR30755	
	65	06/91 → 09/94	B	AR30753, AR30755	
	66	06/91 → 09/94	B	AR30753, AR30755	
1.5	77	01/90 → 04/93	B	AR30734	
1.5 i.e.	71	01/90 → 09/94	B	AR30751	
	74	07/90 → 08/91	B	AR30750	
1.7 16V	101	01/90 → 03/92	B	AR30746	
	95	01/90 → 09/94	B	AR30747	
	97	01/90 → 03/92	B	AR30747	
1.7 16V 4x4	101	01/90 → 03/92	B	AR30746	
	95	01/90 → 09/94	B	AR30747	
	97	01/90 → 09/94	B	AR30747	
1.7 i.e.	77	04/92 → 09/94	B	AR30737	
	77	04/92 → 09/94	B	AR30737A	
	79	01/90 → 09/94	B	AR30736, AR30737	
1.7 i.e. 4x4	79	01/90 → 03/92	B	AR30736, AR30737	
	79	01/90 → 03/92	B	AR30736, AR30737	

**145**

1.4 i.e.	66	07/94 → 12/96	B	AR33501	07-1994 →, → 09-1996
1.6 i.e.	76	10/94 → 12/96	B	AR33201	
1.7 i.e. 16V	95	10/94 → 12/96	B	AR33401	

## 11706T 351170620000



### ALFA ROMEO

#### 146

1.4 i.e.	66	12/94 → 12/96	B	AR33501	05-1995 →, → 09-1996
1.6 i.e.	76	12/94 → 12/96	B	AR33201	05-1995 →, → 09-1996
1.7 i.e. 16V	95	12/94 → 12/96	B	AR33401	05-1995 →, → 09-1996

## 11707 350911707000



**PULEGGIA**

Versione BC

Diametro Puleggia Ø108

Numero Denti/Gole Puleggia 1

Posizione Attacco 70.5

Diametro Girante Ø67

N° Alette Girante 7

Posizione Girante 4.6



### ALFA ROMEO

#### 75

2.5 V6 Cat.	113	09/86 → 05/90	B	AR01648	BC
3.0 V6	136	01/87 → 02/92	B	AR06120, AR06124	BC

## 11708T 351170820000



**FLANGIA**

Numero Fori Flangia 3

Dimensione Fori Flangia M6×1

Posizione Attacco 87

Diametro Mozzo Ø27

Diametro Centraggio Ø28

Diametro Girante Ø65.5

N° Alette Girante 5

Posizione Girante 9.5



### ALFA ROMEO

#### 155

1.7 T.S.	83	04/93 → 04/96	B	AR67103	
	85	04/93 → 04/96	B	AR67105	
1.8 T.S.	77	02/92 → 12/97	B	AR67402	07-1993 →, → 04-1996
	95	02/92 → 06/93	B	AR67101	03-1992 →, → 06-1993

## 11708T 351170820000



### ALFA ROMEO

#### 155

1.8 T.S. Sport	93	01/92 → 12/96	B	AR67101, AR67102	07-1993 →, → 04-1996
	104	02/92 → 02/95	B	AR67202	
2.0 T.S.	106	02/92 → 04/93	B	AR67201	

## 19532/E 351953205000



**FLANGIA**

Numero Fori Flangia 3

Dimensione Fori Flangia M6×1

Posizione Attacco 90

Diametro Centraggio Ø44.8

Diametro Girante Ø67

N° Alette Girante 7

Posizione Girante 4.6



### ALFA ROMEO

#### 75

3.0 V6	141	02/90 → 02/92	B	AR61503	
--------	-----	---------------	---	---------	--

#### 164

2.0 V6 Turbo	148	09/92 → 09/98	B	AR64102	
	150	03/91 → 09/92	B	AR64101	
2.5 V6	120	09/92 → 09/98	B	AR66201	
3.0 i.e. QV	147	09/90 → 09/92	B	AR06430, AR64301	
3.0 V6	132	09/92 → 09/98	B	AR64303, AR64305, AR64399, AR66303	
	135	06/87 → 09/92	B	AR06412	
	141	06/87 → 09/92	B	AR06410	

### FIAT

#### Croma I

2500 V6	119	06/93 → 08/96	B	834G.000	
---------	-----	---------------	---	----------	--

**81300**
**350981300000**

**PULEGGIA**

Diametro Puleggia	Ø104
Numero Denti/Gole Puleggia	1
Posizione Attacco	163.6
Diametro Girante	Ø53.8
N° Alette Girante	6
Posizione Girante	40.3

**KW**

**FIAT**
**Cinquecento**

0.9	30	07/91 → 12/93	B	170A1.000	(-)AC
0.9 i.e.	30	07/91 → 12/93	B	170A1.046	(-)AC

**Panda I, Van**

900	29	04/92 → 12/96	B	1170A1.046	
	33	10/80 → 06/94	B	100GL3.000, 146A.000	01-1992 →

**Seicento, Van**

0.9	29	01/98 → 01/10	B	1170A1.046	
-----	----	---------------	---	------------	--

**81301**
**350981301000**

**PULEGGIA**

Diametro Puleggia	Ø103
Numero Denti/Gole Puleggia	1
Posizione Attacco	165
Diametro Girante	Ø53.8
N° Alette Girante	6
Posizione Girante	40.3

**KW**

**FIAT**
**Cinquecento**

0.9	30	07/91 → 12/93	B	170A1.000	(+)AC
0.9 i.e.	30	07/91 → 12/93	B	170A1.046	(+)AC
0.9 i.e. S	29	07/91 → 07/99	B	1170A1.000, 1170A1.046	

**81302**
**350981302000**

**FLANGIA**

Numero Fori Flangia	1
Dimensione Fori Flangia	Ø4
Posizione Attacco	70
Diametro Mozzo	M26×1.5
Diametro Centraggio	Ø27
Diametro Girante	Ø70.5
N° Alette Girante	7
Posizione Girante	29

**KW**

**ALFA ROMEO**
**33 II, Sportwagon**

1.8 TD	62	07/90 → 09/94	D	VM96A	
--------	----	---------------	---	-------	--

**155**

2.5 TD	92	04/93 → 12/97	D	VM07B, VM31B	04-1993 →
--------	----	---------------	---	-----------------	-----------

**164**

2.5 TD	84	06/87 → 09/92	D	VM84A	10-1989 →
--------	----	---------------	---	-------	-----------

**CHRYSLER**
**Voyager II**

2.5 i	72	01/91 → 09/95	B	K00	
	74	08/90 → 09/95	B	K	
2.5 TD	87	01/92 → 09/95	D	09B, M00	

**FORD**
**Scorpio I, Station Wagon**

2.5 TD	85	08/93 → 09/94	D	SCB	→ 09-1993
	85	08/93 → 09/94	D	SCB	

**Scorpio II, Station Wagon**

2.5 TD	85	10/94 → 08/98	D	SCC	→ 09-1996
	85	10/94 → 08/98	D	SCC	06-1996 →

**ROVER**
**800**

825 D/SD	87	01/90 → 02/99	D	425SL1RR, 4924SHIRG	→ 02-1996
825 SD	87	09/93 → 02/99	D	425SL1RR, 4924SHIRG	→ 02-1996
825 Si	129	04/96 → 02/99	B	25K4F	

**81303**
**350981303000**

**PULEGGIA**

Diametro Puleggia	Ø118.5
Numero Denti/Gole Puleggia	6
Posizione Attacco	73.45
Diametro Girante	Ø60
N° Alette Girante	8
Posizione Girante	41.5

**KW**

**FIAT**
**Punto I, Cabrio, Van**

1.4 GT	96	09/96 → 09/99	B	176B6.000	(+)COP
Turbo	98	01/94 → 09/96	B	176A4.000	(+)COP
1.6	65	01/94 → 04/97	B	176A9.000	(+)COP

**Elba**

1.5	52	04/86 → 10/92	B	149C1.000	(+)COP, (+)AC
-----	----	---------------	---	-----------	---------------

**Marea, Weekend**

1.9 TD 75	55	09/96 → 05/02	D	182A8.000	(+)COP, 05-1999 →
-----------	----	---------------	---	-----------	-------------------

**Palio I, Weekend**

1.4	51	04/96 →	B	178B2.000	(+)COP, (+)AC
1.4 Cat.	51	04/96 →	B	178B2.016	(+)COP, (+)AC

**Punto I, Cabrio, Van**

90 1.6	65	04/94 → 04/97	B	176A9.000	(+)COP
--------	----	---------------	---	-----------	--------

**Siena I**

1.4	51	04/96 → 12/09	B	178B2.000	(+)COP, (+)SS, (+)AC
1.4 Cat.	51	04/96 → 12/09	B	178B2.016	(+)COP, (+)SS, (+)AC

**Tempra, Station Wagon**

1.4 i.e.	51	03/92 → 08/96	B	160A1.046, 836A4.000	(+)COP, 01-1993 →, M →: 9.336.693, (+)AC
	51	10/92 → 08/96	B	160A1.046, 836A4.000	(+)COP, 01-1993 →, (+)AC
	57	03/91 → 08/96	B	159A2.000	(+)COP, 01-1993 →, (+)AC
1.6 i.e.	55	06/92 → 08/96	B	159A3.048, 835C1.000	(+)COP, (+)AC
	57	10/90 → 08/96	B	159A3.046, 835C1.000	(+)COP, 01-1993 →, (+)AC
	63	06/94 → 08/96	B	159B9.000	(+)COP, (+)AC
	66	06/94 → 08/96	B	159B9.000	(+)COP, (+)AC

**81303**
**350981303000**

**KW**

**LANCIA**
**Dedra, Station Wagon**

1.6	66	10/94 → 07/99	B	159B9.000	(+)COP
1.6 16V	76	01/96 → 07/99	B	182A4.000	(+)COP
1.6 i.e.	55	04/93 → 07/99	B	835C1.000	(+)COP
1.6 LE	66	07/94 → 07/99	B	159B9.000	(+)COP

**Delta II**

1.4 i.e.	51	10/94 → 08/99	B	160A1.046, 836A4.000	(+)COP, 04-1995 →
1.6 i.e.	55	06/93 → 08/99	B	835C1.000	(+)COP, 04-1995 →, (+)SS, (+)AC

**81304**
**350981304000**

**FLANGIA**

Numero Fori Flangia	3
Dimensione Fori Flangia	M8×1.25
Posizione Attacco	61.55
Diametro Mozzo	Ø22
Diametro Centraggio	Ø25.95
Diametro Girante	Ø70
N° Alette Girante	9
Posizione Girante	28.4

**KW**

**FIAT**
**Punto I, Cabrio, Van**

1.7 TD	51	01/94 → 09/99	D	176A3.000	(+)COP, → 08-1996
	52	01/94 → 09/99	D	176A5.000	(+)COP, → 08-1996

**Palio I, Weekend**

1.7 TD	51	04/96 → 03/01	D	176A3.000	(+)COP, → 09-1999, → M: 2.427.906
--------	----	---------------	---	-----------	-----------------------------------

**Punto I, Cabrio, Van**

1.7 D	42	04/96 → 02/00	D	176B3.000	(+)COP
1.7 TD	46	09/96 → 09/99	D	176B7.000	(+)COP
	52	04/96 → 02/00	D	176A5.000	(+)COP

**Strada**

1.7 TD	51	06/99 →	D	176A3.000	(+)COP, → M: 2.427.906
--------	----	---------	---	-----------	------------------------

**JEEP**
**Wrangler II**

2.4	105	11/02 → 04/07	B	ED1	(+)COP
-----	-----	---------------	---	-----	--------

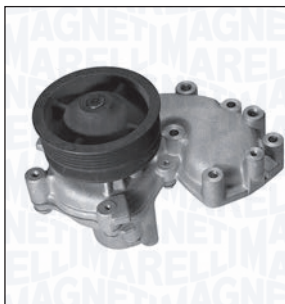
**81309**
**350981309000**

**PULEGGIA**

Diametro Puleggia Ø100  
 Numero Denti/Gole Puleggia 6  
 Posizione Attacco 80.6  
 Diametro Girante Ø70  
 N° Alette Girante 7  
 Posizione Girante 28

**KW**

**FIAT**
**Croma I**

1900 Turbo D i.d.	66	05/89 → 10/92	D	154C6.000	T →: 286.050
-------------------	----	---------------	---	-----------	--------------

**81314**
**350981314000**

**PULEGGIA**

Diametro Puleggia Ø122.5  
 Numero Denti/Gole Puleggia 4  
 Posizione Attacco 76.7  
 Diametro Girante Ø65  
 N° Alette Girante 7  
 Posizione Girante 50

**KW**

**FIAT**
**Fiorino III, Pick Up (Uno)**

1.4	49	05/94 → 05/01	B	146D5.000	(-)COP, → M: 9.470.268
	52	11/92 → 10/96	B	146C5.000	(-)COP, → M: 9.470.268
1.6	55	01/94 → 05/01	B	146C6.000, 146D6.000	(-)COP, → M: 9.470.268
70 i.e. 1.4	49	05/94 → 05/01	B	146C5.000, 146D5.000	(-)COP, → M: 9.470.268
75 i.e. 1.6	55	10/93 → 05/01	B	146C6.000, 146D6.000	(-)COP, → M: 9.470.268

**Tempra, Station Wagon**

1.4 i.e.	51	03/92 → 08/96	B	160A1.046, 836A4.000	(-)COP, → M: 9.336.692, (+)AC
	57	03/91 → 08/96	B	159A2.000	(-)COP, → M: 9.336.692, (+)AC

**81314**
**350981314000**

**KW**

**FIAT**
**Tempra, Station Wagon**

1.6	51	04/90 → 06/93	B	159A3.048	(-)COP, (+)AC
	63	12/90 → 04/93	B	159A3.000	(-)COP, (+)AC
	63	03/90 → 04/93	B	159A3.000, 159B9.000	(-)COP, (+)AC
1.6 i.e.	57	06/90 → 07/92	B	159A3.046	(-)COP, (+)AC
	57	10/90 → 08/96	B	159A3.046, 835C1.000	(-)COP, → 12-1992, (+)AC

**Tipo I**

1.4 i.e.	57	05/89 → 04/95	B	159A2.000	(-)COP, (+)AC
	51	05/89 → 04/95	B	160A1.046, 836A4.000	(-)COP, (+)AC
1.6	61	01/88 → 10/91	B	160A2.000	(-)COP, (+)AC
1.6 i.e.	55	10/92 → 04/95	B	159A3.048, 835C1.000	(-)COP, (+)AC
	57	07/90 → 01/93	B	159A3.046	(-)COP, (+)AC

**Uno I**

70 i.e. 1.4	51	09/89 → 12/93	B	160A1.046	(-)COP, (+)AC
	53	09/89 → 12/93	B	146C1.000	(-)COP, (+)AC

**INNOCENTI**
**Elba**

1.4 i.e.	49	09/94 → 12/96	B	146C5.000, 146D5.000	(-)COP, → 02-1995
1.6 i.e.	55	09/94 → 12/96	B	146C6.000, 146D6.000	(-)COP

**LANCIA**
**Dedra, Station Wagon**

1.6 i.e.	57	08/89 → 03/93	B	835A1.046	(-)COP
	66	08/89 → 06/94	B	835A1.000	(-)COP

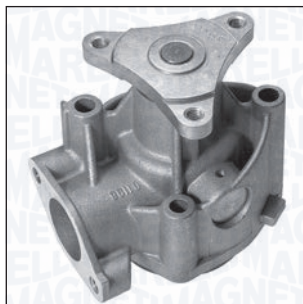
**81315**
**350981315000**

**FLANGIA**

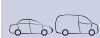
Numero Fori Flangia	3
Dimensione Fori Flangia	M8x1.25
Posizione Attacco	95.5
Diametro Centraggio	Ø57
Diametro Girante	Ø68
N° Alette Girante	12
Posizione Girante	17.2

**KW**

**FIAT**
**Tempra, Station Wagon**

1.8 i.e.	66	09/93 → 08/96	B	835C4.000	
	74	10/94 → 08/96	B	836A5.000	01-1992 →, → 07-1996
	74	10/94 → 08/96	B	836A5.000	
	76	09/93 → 08/96	B	835C2.000	01-1992 →, → 07-1996
	76	09/93 → 08/96	B	835C2.000	
	77	03/92 → 08/96	B	159A4.046	01-1992 →, → 07-1996
	77	03/92 → 12/93	B	159A4.046	
	81	03/90 → 08/96	B	159A4.000	07-1992 →
2.0 i.e.	83	10/90 → 08/96	B	159A6.046	01-1992 →
2.0 i.e. 4x4	83	03/92 → 03/95	B	159A6.046	

**Tipo I**

1.8 i.e.	71	03/93 → 04/95	B	836A5.000	
	66	09/93 → 04/95	B	835C4.000	
	81	10/90 → 06/93	B	159A4.000	
	74	10/94 → 10/95	B	159A4.000, 836A5.000	
	76	04/93 → 04/95	B	835C2.000	
	77	10/90 → 06/93	B	159A4.046	
	2.0 16V	107	07/91 → 04/95	B	160A8.046
2.0 i.e.	80	06/90 → 03/92	B	159A5.046	07-1991 →
	83	03/90 → 04/95	B	159A6.046	07-1991 →

**LANCIA**
**Dedra, Station Wagon**

1.8 i.e.	66	08/93 → 07/99	B	835C5.000	
	74	07/94 → 07/99	B	836A5.000	
	77	09/89 → 07/99	B	835A2.046	05-1994 →
2.0 HF Integrale	124	11/90 → 07/94	B	835A7.046	
2.0 i.e.	83	09/89 → 07/99	B	835A5.046	05-1994 →
2.0 i.e. Turbo	119	04/91 → 07/99	B	835A8.046	
2.0 i.e. Turbo Integrale	121	05/90 → 07/94	B	835A7.000	
2.0 Turbo	130	11/90 → 06/94	B	835A8.000	

**81315**
**350981315000**

**KW**

**LANCIA**
**Delta II**

1.8 i.e.	66	07/94 → 08/99	B	835C4.000, 836A6.000, 836C4.000	
	76	06/93 → 08/99	B	835C2.000	

**81316**
**350981316000**

**FLANGIA**

Numero Fori Flangia	3
Dimensione Fori Flangia	M8x1.25
Posizione Attacco	78
Diametro Centraggio	Ø50
Diametro Girante	Ø93.5
N° Alette Girante	8
Posizione Girante	14.5

**KW**

**CITROËN**
**Jumper I**

2.8 D	64	01/99 → 02/02	D	8140.63 (F28D)	
2.8 HDi	93	10/00 → 01/02	D	8140.43S	
	94	09/00 → 04/02	D	8140.43S	
2.8 HDi 4x4	94	09/00 → 04/02	D	8140.43S	

**Jumper II**

2.8 HDi	94	04/02 →	D	8140.43S	
	107	05/04 →	D	8140.43N	
	107	05/04 →	D	8140.43N	
2.8 HDi 4x4	94	04/02 →	D	8140.43S	
	94	02/02 → 06/06	D	F28TDCR	
2.8 HDi Trazione integrale	94	04/02 →	D	8140.43S	

**FIAT**
**Ducato III**

2.5 D	62	03/94 → 04/02	D	8140.67	
2.5 D 4x4	62	03/94 → 04/02	D	8140.67	
2.5 D Combinato	62	08/94 → 04/02	D	8140.67	
2.5 TD	80	06/94 → 08/98	D	8140.47	
	85	06/94 → 04/98	D	8140.47	
2.5 TD 4x4	80	11/94 → 04/98	D	8140.47	
	85	11/94 → 04/98	D	8140.47	
2.5 TDI	80	03/94 → 04/02	D	8140.47R	
	85	03/94 → 04/02	D	8140.47	



**81316 350981316000**

**FIAT**
**Ducato III**

2.5 TDI 4x4	85	04/97 → 04/02	D	8140.47	
2.5 TDI Panorama/ Combinato	80	07/94 → 04/02	D	8140.47R	
	85	03/94 → 04/02	D	8140.47	
2.8 D	64	02/98 → 04/02	D	8140.63	
2.8 D 4x4	64	08/98 → 04/02	D	8140.63	
2.8 iDTD 4x4	90	05/98 → 09/01	D	8140.43	
2.8 JTD	94	11/00 → 04/02	D	8140.43S	
	94	03/01 → 04/02	D	8140.43S	
2.8 JTD 4x4	94	11/00 → 04/02	D	8140.43S	
	94	10/01 → 04/02	D	8140.43S	
2.8 TD 4x4	64	05/98 → 11/01	D	8140.63	
	90	05/98 → 09/01	D	8140.43	
2.8 TDI	90	10/97 → 04/02	D	8140.43	
2.8 TDI 4x4	90	07/99 → 04/02	D	8140.43	

**Ducato IV**

2.8 JTD	94	04/02 →	D	8140.43S	
	107	04/04 → 07/06	D	8140.43N	
2.8 JTD 4x4	94	07/02 →	D	8140.43S	
2.8 JTD Power	107	05/04 →	D	8140.43N	

**PEUGEOT**
**Boxer I**

2.5 D	63	08/94 → 04/02	D	T9A (DJ5)	01-1999 →, M: SOFIM
2.5 D 4x4	63	07/96 → 04/02	D	T9A (DJ5)	M: SOFIM
2.5 TD 4x4	76	07/96 → 04/02	D	T8A (DJ5T)	M: SOFIM
2.8 D	64	01/99 → 02/02	D	8140.63 (F28D)	
2.8 HDi	93	10/00 → 11/01	D	8140.43S (F28DTCR)	
	94	11/00 → 04/02	D	8140.43S (F28DTCR)	
2.8 HDi 4x4	93	10/00 → 11/01	D	8140.43S (F28DTCR)	
	94	10/00 → 04/02	D	8140.43S (F28DTCR)	
2.8 HDi Trazione integrale	93	10/00 → 11/01	D	8140.43S (F28DTCR)	

**81316 350981316000**

**PEUGEOT**
**Boxer II**

2.8 HDi	94	04/02 →	D	8140.43S (F28DTCR)	
	107	04/04 →	D	8140.43N	
2.8 HDi 4x4	94	04/02 →	D	8140.43S (F28DTCR)	

**81318 350981318000**

	<b>PULEGGIA</b>			
	Diametro Puleggia			Ø99.5
	Numero Denti/Gole Puleggia			6
	Posizione Attacco			80.6
	Diametro Girante			Ø70
	N° Alette Girante			9
	Posizione Girante			28

**FIAT**
**Ducato III**

1.9 TD	60	03/94 → 04/02	D	230A3.000	(-)AC
1.9 TD CAT	59	08/94 → 04/02	D	230A4.000	(-)AC
1.9 TD Combinato	59	08/94 → 04/02	D	230A4.000	(-)AC
1.9 TD Panorama/ Combinato	60	03/94 → 04/02	D	230A3.000	(-)AC

**81319 350981319000**

	<b>PULEGGIA</b>			
	Diametro Puleggia			Ø99.5
	Numero Denti/Gole Puleggia			7
	Posizione Attacco			84.15
	Diametro Girante			Ø70
	N° Alette Girante			9
	Posizione Girante			28

**FIAT**
**Ducato III**

1.9 TD	60	03/94 → 04/02	D	230A3.000	(+)AC
1.9 TD CAT	59	08/94 → 04/02	D	230A4.000	(+)AC
1.9 TD Combinato	59	08/94 → 04/02	D	230A4.000	(+)AC

## 81319 350981319000



### FIAT

#### Ducato III

1.9 TD Panorama/Combinato	60	03/94 → 04/02	D	230A3.000	(+)AC
---------------------------	----	---------------	---	-----------	-------

## 81320 350981320000



**FLANGIA**

Numero Fori Flangia	3
Dimensione Fori Flangia	M8×1.25
Posizione Attacco	78.5
Diametro Mozzo	Ø22
Diametro Centraggio	Ø25.95
Diametro Girante	Ø70
N° Alette Girante	7
Posizione Girante	28.4



### FIAT

#### Ducato III

1.9 D	51	03/94 → 04/02	D	230A2.000	03-1994 →
1.9 D Combinato	51	06/95 → 04/02	D	230A2.000	

## 81322 350981322000



**FLANGIA**

Numero Fori Flangia	3
Dimensione Fori Flangia	M8×1.25
Posizione Attacco	95.5
Diametro Centraggio	Ø57
Diametro Girante	Ø68
N° Alette Girante	12
Posizione Girante	17.2



### ALFA ROMEO

#### 155

2.0 16V Turbo Q4	140	01/92 → 12/97	B	AR67203	07-1992 →, → 02-1996
	137	01/92 → 12/97	B	AR67203	07-1992 →, → 02-1996

### FIAT

#### Coupé

2.0 16V	102	11/93 → 08/96	B	836A3.000	02-1994 →
2.0 16V Turbo	140	11/93 → 08/96	B	175A1.000	02-1994 →

## 81322 350981322000



### FIAT

#### Tipo I

2.0 i.e. 16V Sport	102	03/93 → 04/95	B	836A3.000	
--------------------	-----	---------------	---	-----------	--

### LANCIA

#### Dedra, Station Wagon

2.0 16V	102	07/94 → 07/99	B	836A3.000	
2.0 Integrale	102	07/94 → 07/99	B	836A3.000	

#### Delta II

2.0 16V	102	06/93 → 08/99	B	836A3.000	
2.0 16V Turbo	137	06/93 → 08/99	B	836A2.000	
	142	07/96 → 08/99	B	175A4.000	

## 81324 350981324000



**PULEGGIA**

Diametro Puleggia	Ø131
Numero Denti/Gole Puleggia	1
Posizione Attacco	64
Diametro Girante	Ø99
N° Alette Girante	7
Posizione Girante	17.35



### FIAT

#### Croma I

2500 TD	85	05/89 → 08/96	D	8144.97,	10-1991 →,
				8144.972400,	→ 12-1992,
				8144.97Y	→ M: 1.340.163
2500 TDE	77	12/91 → 08/96	D	8144.97S	→ 12-1992, M →: 1.340.163

### LANCIA

#### Thema I, Station Wagon

2500 Turbo DS	85	06/88 → 05/92	D	8144.97	11-1991 →
	77	05/88 → 07/92	D	8144.97S	11-1991 →

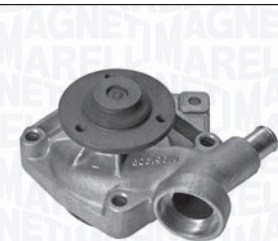
**81325**
**350981325000**

**FLANGIA**

Numero Fori Flangia	3
Dimensione Fori Flangia	M8x1.25
Posizione Attacco	62.6
Diametro Centraggio	Ø50
Diametro Girante	Ø95.5
N° Alette Girante	7
Posizione Girante	21.1

**KW**

**FIAT**
**Croma I**

2500 TD	85	05/89 → 08/96	D	8144.97, 8144.97.2400, 8144.97Y	01-1993 →
2500 TDE	77	12/91 → 08/96	D	8144.97S	01-1993 →

**LANCIA**
**Thema I, Station Wagon**

2500 Turbo DS	85	05/92 → 07/94	D	8144.97Y	
---------------	----	---------------	---	----------	--

**RENAULT**
**Safrane I**

2.5 dT	83	12/92 → 07/96	D	S8U762, S8U763	
--------	----	---------------	---	-------------------	--

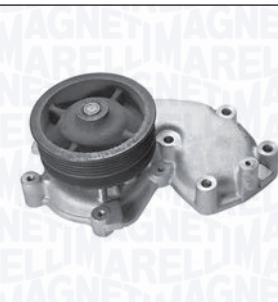
**81326**
**350981326000**

**PULEGGIA**

Diametro Puleggia	Ø100
Numero Denti/Gole Puleggia	6
Posizione Attacco	80.6
Diametro Girante	Ø70
N° Alette Girante	7
Posizione Girante	28

**KW**

**ALFA ROMEO**
**145**

1.9 TD	66	10/94 → 02/99	D	AR33601, AR67501	(-)COP, 10-1994 →, → 02-1999
--------	----	---------------	---	---------------------	------------------------------------

**146**

1.9 TD	66	12/94 → 02/99	D	AR33601, AR67501	(-)COP, 12-1994 →, → 09-1996
--------	----	---------------	---	---------------------	------------------------------------

**81326**
**350981326000**

**KW**

**ALFA ROMEO**
**155**

1.9 TD	66	04/93 → 12/97	D	AR67501	(-)COP, 04-1993 →, → 02-1996
--------	----	---------------	---	---------	------------------------------------

**FIAT**
**Tempra, Station Wagon**

1.9 TD	66	05/90 → 08/96	D	160A6.000, 160D1.000	(-)COP, → M: 1.071.902, (+)AC
--------	----	---------------	---	-------------------------	-------------------------------------

**Tipo I**

1.9 TD	59	03/92 → 06/93	D	160B6.046	(-)COP, → 12-1992, (+)SS, (+)AC
	66	09/90 → 04/95	D	160A6.000, 160A6.046, 160D1.000	(-)COP, → 12-1992, (+)AC, (+)SS, (+)AC

**LANCIA**
**Dedra, Station Wagon**

1.9 TDS	66	04/89 → 07/99	D	160D1.000, 835A4.000, 835A4.046	(-)COP, → 04-1994
---------	----	---------------	---	---------------------------------------	----------------------

**81329**
**350981329000**

**PULEGGIA**

Diametro Puleggia	Ø60.5
Altezza Puleggia	29
Posizione Attacco	39
Diametro Girante	Ø76
N° Alette Girante	8
Posizione Girante	17.2

**KW**

**FIAT**
**Brava**

2.0	113	09/98 → 08/00	B	182B7.000	
-----	-----	---------------	---	-----------	--

**Bravo I**

2.0 HGT 20V	108	10/95 → 07/98	B	182A1.000	10-1995 →
	113	07/98 → 10/01	B	182B7.000	

**Coupé**

2.0 20V	108	08/96 → 04/98	B	182A1.000	09-1996 →
	113	04/98 → 08/00	B	182B3.000	
2.0 20V Turbo	162	08/96 → 08/00	B	175A3.000	09-1996 →

## 81329 350981329000



### FIAT

#### Marea, Weekend

2.0 150 20V	108	09/96 → 04/99	B	182A1.000	10-1996 →
	110	01/01 → 05/02	B	185A8.000	
2.0 155 20V	113	04/99 → 01/01	B	182B7.000	

#### Stilo, Station Wagon

2.4 20V	125	10/01 → 11/06	B	192A2.000	
---------	-----	---------------	---	-----------	--

### LANCIA

#### Kappa, Station Wagon, Coupé

2.0 20V	114	07/96 → 03/01	B	838A6.000	
	107	10/94 → 10/01	B	838A1.000	
	114	07/96 → 10/01	B	838A6.000	
2.0 20V Turbo	162	06/98 → 10/01	B	175A3.000	
2.4 20V	129	11/96 → 03/01	B	838A2.000	
	129	08/94 → 10/01	B	838A2.000, 838A2.027	

#### Lybra, Station Wagon

2.0 20V	110	09/00 → 10/05	B	185A8.000	
	113	07/99 → 09/00	B	182B7.000	
2.4 20V	125	10/01 → 10/05	B	192A2.000	

#### Thesis

2.0 Turbo	136	07/02 → 07/09	B	841E.000	
2.4	125	07/02 → 07/09	B	841D.000	

## 81330 350981330000



<b>PULEGGIA</b>	
Diametro Puleggia	Ø48
Altezza Puleggia	32
Posizione Attacco	39.2
Diametro Girante	Ø76
N° Alette Girante	8
Posizione Girante	17.2



### FIAT

#### Brava

1.9 JTD	74	09/00 → 10/01	D	182B9.000	
1.9TD 100 S	74	03/96 → 10/01	D	182A7.000	09-1996 →

#### Bravo I

1.9 JTD	74	09/00 → 10/01	D	182B9.000	
1.9TD 100 S	74	03/96 → 10/01	D	182A7.000	09-1996 →

## 81330 350981330000



### FIAT

#### Marea, Weekend

1.9 TD 100	74	09/96 → 05/02	D	182A7.000	
	74	09/96 → 05/02	D	182A7.000, 182B9.000	
1.9 TD 75	55	09/96 → 05/02	D	182A8.000	→ 04-1999
2.4 JTD 130	96	04/99 → 05/02	D	185A6.000, 839A5.000	
2.4 TD 125	91	09/96 → 04/99	D	185A2.000	11-1996 →

### LANCIA

#### Kappa, Station Wagon, Coupé

2.4 T.DS	91	08/94 → 10/01	D	838A3.000, 838A7.000	→ 08-1997, → M: 727.390
----------	----	---------------	---	----------------------	-------------------------

## 81331 350981331000



<b>PULEGGIA</b>	
Diametro Puleggia	Ø71.1
Altezza Puleggia	30.3
Posizione Attacco	38.9
Diametro Girante	Ø76
N° Alette Girante	8
Posizione Girante	17.2



### ALFA ROMEO

#### 145

1.4 i.e. 16V T.S.	76	12/96 → 01/01	B	AR33503, AR38501	
1.8 i.e. 16V	106	03/98 → 01/01	B	AR32201	
1.8 i.e. 16V T.S.	103	12/96 → 12/98	B	AR38401, AR67106, AR67199	
2.0 16V Quadrifoglio	114	03/98 → 01/01	B	AR32301	
2.0 16V T.S.	110	10/95 → 01/01	B	AR67204	

#### 146

1.4 i.e. 16V T.S.	76	11/96 → 01/01	B	AR33503, AR38501	
1.8 i.e. 16V T.S.	103	11/96 → 01/01	B	AR38401, AR67106	
	106	03/98 → 01/01	B	AR32201	
2.0 16V Quadrifoglio	114	03/98 → 01/01	B	AR32301	
2.0 16V T.S.	110	10/95 → 01/01	B	AR67204	10-1995 →

**81331 350981331000**

**ALFA ROMEO**
**147**

1.6 16V T.SPARK	88	01/01 → 03/10	B	AR32104	
1.6 16V T.SPARK ECO	77	01/01 → 03/10	B	AR37203	
2.0	121	07/02 → 05/05	B	937A1.000	
2.0 16V T.SPARK	110	01/01 → 03/10	B	AR32310	

**155**

2.0 T.S. 16V	110	03/95 → 12/97	B	AR67204, AR67299	
--------------	-----	---------------	---	------------------	--

**156, Sportwagon**

1.6 16V T.SPARK	88	09/97 → 09/05	B	AR32102, AR32103, AR32104, AR67601	05-2000 →
	88	05/00 → 05/06	B	AR32102, AR32103, AR32104, AR67601	
1.8 16V T.SPARK	106	05/00 → 10/00	B	AR32201	
2.0 16V T.SPARK	110	10/00 → 03/02	B	AR32310	
	114	09/97 → 10/00	B	AR32301	11-1997 →
	114	05/00 → 06/02	B	AR32301	
2.0 JTS	119	11/97 → 09/05	B	932A2.000	
2.0 JTS	122	03/02 → 09/05	B	937A1.000	

**159, Sportwagon**

1.8 TBi	147	05/09 → 11/11	B	939B1.000	
---------	-----	---------------	---	-----------	--

**166**

2.0 T.Spark	110	10/00 → 06/07	B	AR36301	
	114	09/98 → 10/00	B	AR34103	

**Brera**

1.8 TBi	147	05/09 → 06/10	B	939B1.000	
---------	-----	---------------	---	-----------	--

**Giulietta III**

1.8 TBi	173	04/10 →	B	940A1.000	
	177	09/13 →	B	960A1.000	

**GT II**

2.0 JTS	119	12/06 → 09/10	B	932A2.000	
	121	11/03 → 09/10	B	932A2.000, 937A1.000	

**81331 350981331000**

**ALFA ROMEO**
**GTV II**

1.8 16V	106	05/98 → 10/05	B	AR32201	
2.0 JTS	121	04/03 → 10/05	B	937A1.000	
2.0 T.SPARK 16V	110	06/95 → 10/05	B	AR16201, AR32310	
	114	05/98 → 08/00	B	AR32301	

**Spider IV**

1.8 16V	106	05/98 → 04/05	B	AR32201	
2.0 JTS	121	04/03 → 04/05	B	937A1.000	
2.0 T.SPARK 16V	110	06/95 → 04/05	B	AR16201, AR32310	
	114	05/98 → 08/00	B	AR32301	

**Spider V**

1.8 TBi	147	05/09 → 06/10	B	939B1.000	
---------	-----	---------------	---	-----------	--

**FIAT**
**Barchetta**

1.8 16V	96	04/95 → 05/05	B	183A1.000, 188A6.000	→ 08-2000
---------	----	---------------	---	----------------------	-----------

**Brava**

1.8 GT 16V	83	10/95 → 10/01	B	182A2.000	10-1995 →
------------	----	---------------	---	-----------	-----------

**Bravo I**

1.8 GT	83	10/95 → 10/01	B	182A2.000	10-1995 →
--------	----	---------------	---	-----------	-----------

**Coupé**

1.8 16V	96	03/96 → 08/00	B	183A1.000	
---------	----	---------------	---	-----------	--

**Marea, Weekend**

1.8 115 16V	83	09/96 → 05/02	B	182A2.000	
-------------	----	---------------	---	-----------	--

**Punto II, Cabrio, Van**

1.8 130 HGT	96	09/99 →	B	183A1.000, 188A6.000	→ 08-2000, M: 183 A1.000
-------------	----	---------	---	----------------------	--------------------------

**LANCIA**
**Dedra, Station Wagon**

1.8 16V LE	83	03/96 → 07/99	B	182A2.000	
1.8 GT 16V	96	03/96 → 07/99	B	183A1.000	

**Delta II**

1.8 i.e. 16V	83	03/96 → 08/99	B	182A2.000	
1.8 i.e. 16V GT	96	03/96 → 08/99	B	183A1.000	

**Delta III**

1.8	147	01/09 → 08/14	B	939B1.000	
-----	-----	---------------	---	-----------	--

**Lybra, Station Wagon**

1.8 16V	96	07/99 → 10/05	B	839A4.000, 839A7.000	
1.8 16V	96	07/99 → 10/05	B	839A4.000, 839A7.000, 839A9.000	

**81331**
**350981331000**

**KW**

**LANCIA**
**Thema I, Station Wagon**

3000 V6 126 08/92 → 07/94 B 834F.000

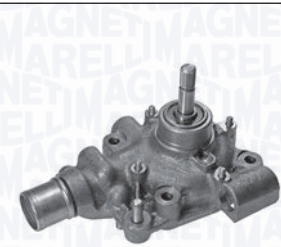
**81332**
**350981332000**

**ALBERINO**

Diametro Alberino M14x1.5 SX  
 Tipo Filetto Alberino Maschio  
 Posizione Attacco 130  
 Diametro Girante Ø93.5  
 N° Alette Girante 8  
 Posizione Girante 14.5

**KW**

**IVECO**
**Daily II**

30-10	76	01/97 → 05/99	D	8140.23.	
30-10 C	76	01/97 → 05/99	D	8140.23.	
30-8	55	01/92 → 08/98	D	8140.07.2700	01-1996 →
	55	01/89 → 08/98	D	8140.07.2700, 8140.07.2712	
	60	01/89 → 08/98	D	8140.67F., 8140.67F.3710, 8140.67F.3711, 8140.67F.3713, 8140.67F.3721	
	60	01/92 → 08/98	D	8140.67F., 8140.67F.3710, 8140.67F.3711, 8140.67F.3713, 8140.67F.3721	01-1996 →
	62	09/98 → 05/99	D	8140.63.	
30-8 V	62	09/98 → 05/99	D	8140.63.	
35-10	76	01/96 → 05/99	D	8140.23.	
35-10 K	76	01/97 → 05/99	D	8140.23.	
35-12	90	05/96 → 05/99	D	8140.43.	
35-12 K	90	09/96 → 08/98	D	8140.43.	
35-8	62	09/98 → 05/99	D	8140.63.	
35-8 K	62	09/98 → 05/99	D	8140.63.	
49-10	76	05/96 → 05/99	D	8140.23.	
49-10 K	76	05/96 → 05/99	D	8140.23.	
49-12	90	05/96 → 05/99	D	8140.43.	
49-12 K	90	05/96 → 05/99	D	8140.43.	
49-12 V	90	05/96 → 05/99	D	8140.43.	
59-12 K	90	05/96 → 05/99	D	8140.43.	
59-12 V	90	05/96 → 05/99	D	8140.43.	

**81333**
**350981333000**

**PULEGGIA**

Diametro Puleggia Ø113.5  
 Numero Denti/Gole Puleggia 6  
 Posizione Attacco 70.7  
 Diametro Girante Ø62  
 N° Alette Girante 7  
 Posizione Girante 58.9

**KW**

**FIAT**
**Tempra, Station Wagon**

1.4 i.e.	51	03/92 → 08/96	B	160A1.046, 836A4.000	→ 12-1992, → M: 9.336.692, (+)SS, (+)AC
	51	10/92 → 08/96	B	160A1.046, 836A4.000	→ 12-1992, → M: 9.336.692
	57	03/91 → 08/96	B	159A2.000	→ 12-1992, → M: 9.336.692
1.6	51	04/90 → 06/93	B	159A3.048	(+)SS, (+)AC
	63	12/90 → 04/93	B	159A3.000	(+)SS, (+)AC
	63	03/90 → 04/93	B	159A3.000, 159B9.000	(+)SS, (+)AC
1.6 i.e.	57	06/90 → 07/92	B	159A3.046	(+)SS, (+)AC
	57	10/90 → 08/96	B	159A3.046, 835C1.000	→ 12-1992, (+)AC, (+)SS, (+)AC

**Tipo I**

1.4 i.e.	57	05/89 → 04/95	B	159A2.000	(+)AC, (+)SS
	51	05/89 → 04/95	B	160A1.046, 836A4.000	(+)AC, (+)SS
1.6	61	01/88 → 10/91	B	160A2.000	(+)AC, (+)SS
1.6 i.e.	55	10/92 → 04/95	B	159A3.048, 835C1.000	(+)AC, (+)SS
	57	07/90 → 01/93	B	159A3.046	(+)AC, (+)SS

**Uno I**

70 i.e. 1.4	51	09/89 → 12/93	B	160A1.046	(+)SS, (+)AC
	53	09/89 → 12/93	B	146C1.000	(+)SS, (+)AC

**LANCIA**
**Dedra, Station Wagon**

1.6 i.e.	57	08/89 → 03/93	B	835A1.046	(+)SS
	66	08/89 → 06/94	B	835A1.000	(+)SS

**Delta II**

1.4 i.e.	51	10/94 → 08/99	B	160A1.046, 836A4.000	→ 03-1995
1.6 i.e.	55	06/93 → 08/99	B	835C1.000	→ 03-1995

**81334**
**350981334000**

**FLANGIA**

Numero Fori Flangia	3
Dimensione Fori Flangia	M8×1.25
Posizione Attacco	82.75
Diametro Mozzo	Ø27.88
Diametro Girante	Ø93.5
N° Alette Girante	8
Posizione Girante	14.5

**KW**

**IVECO**
**Daily II**

30-8	55	01/92 → 08/98	D	8140.07.2700	→ 12-1995
	60	01/92 → 08/98	D	8140.67F.	→ 12-1995
35-10	68	01/89 → 12/96	D	8140.97.2781	01-1991 →, → 12-1995
	76	01/89 → 12/96	D	8140.47R.2790	01-1991 →, → 12-1995
40-10 V	76	01/90 → 04/96	D	8140.27.2720	
45-10	76	01/89 → 04/96	D	8140.27.2720	
45-10 V	76	01/89 → 04/96	D	8140.27.2720	
49-10	76	01/89 → 04/96	D	8140.27.2700, 8140.47R.2790	
49-10 K	76	01/89 → 04/96	D	8140.27.2700, 8140.47R.2790	
49-10 V	76	01/89 → 04/96	D	8140.27.2700, 8140.47R.2790	
A 40-10	76	01/91 → 12/96	D	8140.27.2720	
	76	01/91 → 04/96	D	8140.27.2720	

**RENAULT**
**Master I**

28-35 2,5 D	55	08/89 → 07/98	D	8140.67.2510, S8U742	
	52	09/80 → 07/98	D	8140.61.2300, S8U731	
	55	08/89 → 07/98	D	8140.67.2510, S8U742	

**Trafic I**

2.5 D	51	05/89 → 03/01	D	8140.61.240, S8U720, S8U722	
	55	05/89 → 03/01	D	8140.67.2500, 8140.67.2550, 8140.67.2580, S8U750, S8U752, S8U758	

**81339**
**350981339000**

**PULEGGIA**

Diametro Puleggia	Ø118.5
Numero Denti/Gole Puleggia	6
Posizione Attacco	73.45
Diametro Girante	Ø60
N° Alette Girante	8
Posizione Girante	41.5

**KW**

**FIAT**
**Punto I, Cabrio, Van**

1.4 GT	96	09/96 → 09/99	B	176B6.000	(-)COP
	Turbo	98	01/94 → 09/96	B	176A4.000
1.6	65	01/94 → 04/97	B	176A9.000	(-)COP

**Palio I, Weekend**

1.4	51	04/96 →	B	178B2.000	(-)COP, (+)AC
1.4 Cat.	51	04/96 →	B	178B2.016	(-)COP, (+)AC

**Punto I, Cabrio, Van**

90 1.6	65	04/94 → 04/97	B	176A9.000	(-)COP, 10-1993 →
--------	----	---------------	---	-----------	----------------------

**Siena I**

1.4	51	04/96 → 12/09	B	178B2.000	(-)COP, (+)SS, (+)AC
1.4 Cat.	51	04/96 → 12/09	B	178B2.016	(-)COP, (+)SS, (+)AC

**Tempra, Station Wagon**

1.4 i.e.	51	03/92 → 08/96	B	160A1.046, 836A4.000	(-)COP, 01-1993 →, M →: 9.336.693, (+)AC
	51	10/92 → 08/96	B	160A1.046, 836A4.000	(-)COP, 01-1993 →, (+)AC
	57	03/91 → 08/96	B	159A2.000	(-)COP, 01-1993 →, (+)AC
1.6 i.e.	55	06/92 → 08/96	B	159A3.048, 835C1.000	(-)COP, (+)AC
	57	10/90 → 08/96	B	159A3.046, 835C1.000	(-)COP, 01-1993 →, (+)AC
	63	06/94 → 08/96	B	159B9.000	(-)COP, (+)AC
	66	06/94 → 08/96	B	159B9.000	(-)COP, (+)AC

**81339**
**350981339000**

**LANCIA**
**Dedra, Station Wagon**

1.6	66	10/94 → 07/99	B	159B9.000	(-)COP
1.6 16V	76	01/96 → 07/99	B	182A4.000	(-)COP
1.6 i.e.	55	04/93 → 07/99	B	835C1.000	(-)COP
1.6 LE	66	07/94 → 07/99	B	159B9.000	(-)COP

**Delta II**

1.4 i.e.	51	10/94 → 08/99	B	160A1.046, 836A4.000	(-)COP, 04-1995 →
1.6 i.e.	55	06/93 → 08/99	B	835C1.000	(-)COP, 04-1995 →, (+) SS, (+)AC

**81340**
**350981340000**

**PULEGGIA**

Diametro Puleggia	Ø60.5
Altezza Puleggia	26
Posizione Attacco	33.5
Diametro Girante	Ø66
N° Alette Girante	8
Posizione Girante	17.2

**FIAT**
**Brava**

1.4	55	10/95 → 10/01	B	182A5.000	→ 12-1997, → M: 705.144
1.4 12 V	59	10/95 → 08/98	B	182A3.000	→ 12-1997, → M: 705.144

**Bravo I**

1.4	55	10/95 → 10/01	B	182A5.000	→ 12-1997, → M: 705.144
	59	10/95 → 10/01	B	182A3.000	→ 12-1997, → M: 705.144

**Marea, Weekend**

1.4 80 12V	59	09/96 → 05/02	B	182A3.000	→ 12-1997, → M: 705.144
------------	----	---------------	---	-----------	----------------------------

**LANCIA**
**Y**

1.4 12V	55	03/96 → 09/03	B	840A4.000	→ M: 705.144
	59	10/96 → 09/03	B	840A2.000	→ M: 705.144

**81341**
**350981341000**

**PULEGGIA**

Diametro Puleggia	Ø118.5 / Ø107
Numero Denti/Gole Puleggia	5 / 3
Posizione Attacco	84.9
Diametro Girante	Ø60
N° Alette Girante	8
Posizione Girante	41.5

**FIAT**
**Brava**

1.6 16V	66	10/95 → 10/01	B	182A6.000	(+)COP
	76	02/96 → 10/01	B	182A4.000	(+)COP
	76	01/99 → 12/02	B	182B6.000	(+)COP

**Bravo I**

1.6	76	09/00 → 10/01	B	182B6.000	(+)COP
1.6 16V	66	10/95 → 10/01	B	182A6.000	(+)COP, 10-1995 →
	76	03/96 → 10/01	B	182A4.000	(+)COP

**Doblò I, Cargo**

1.6	68	09/02 →	B	182B6.000	(+)COP
1.6 16V	76	10/01 →	B	182B6.000	(+)COP
1.6 Natural Power	76	09/02 →		182B6.000	(+)COP

**Marea, Weekend**

1.6	68	03/99 → 08/00	B	185A3.000	(+)COP
	76	09/00 → 08/02	B	182B6.000	(+)COP
1.6 100 16V	76	09/96 → 05/02	B	182A4.000	(+)COP
	76	04/99 → 05/02		185A3.000, 186A4.000	(+)COP
1.6 16V	75	04/97 → 02/99	B	185A3.000	(+)COP
1.6 SX	72	09/00 → 08/02	B	182B5.098	(+)COP

**Multipla**

1.6	68	05/04 → 08/05	G	182B6.000	(+)COP
	74	03/01 → 08/05	G	182B6.000	(+)COP
	76	09/00 → 06/10	B	182B6.000	(+)COP
1.6 100 16V	76	04/99 → 06/10	B	182A4.000	(+)COP
1.6 16V	70	04/02 → 06/10	B	182B6.000	(+)COP
1.6 16V Bipower	76	04/99 → 06/10		186A4.000	(+)COP
	76	10/01 → 06/10		182B6.000	(+)COP
1.6 16V Blupower	70	04/99 → 06/10	G	186A3.000	(+)COP

**Palio I, Weekend**

1.5	62	02/02 →	B	178E5.022	(+)COP
1.6	68	07/97 → 10/03	B	178C7.098, 178D2.011	(+)COP
1.6 16V	74	04/96 →	B	178B3.000	(+)COP



**81341 350981341000**

**FIAT**
**Palio I, Weekend**

1.6 16V	74	04/96 → 02/01	B	178B3.000	(+)COP, 07-1997 →
	76	02/01 →	B	182B6.000	(+)COP

**Siena I**

1.5 Bipower	57	09/03 → 12/05	BF	178A6.011	(+)COP
1.6	76	11/00 → 12/09	B	182B6.000	(+)COP
1.6 16V	78	09/98 → 12/09	B	178B3.000	(+)COP

**Stilo, Station Wagon**

1.6 16V	76	01/03 → 08/08	B	182B6.000	(+)COP
	77	05/05 → 11/06	B	192B3.000	(+)COP
	76	10/01 → 11/06	B	182B6.000	(+)COP

**LANCIA**
**Delta II**

1.6 i.e.	66	03/96 → 08/99	B	182A6.000	(+)COP
1.6 i.e. 16V	76	01/96 → 08/99	B	182A4.000	(+)COP

**Lybra, Station Wagon**

1.6	76	10/00 → 10/05	B	182B6.000	(+)COP
1.6 16V	76	07/99 → 10/05	B	182A4.000, 182B6.000	(+)COP

**81342 350981342000**

**PULEGGIA**

Diametro Puleggia	Ø100
Numero Denti/Gole Puleggia	7
Posizione Attacco	85.25
Diametro Girante	Ø70
N° Alette Girante	9
Posizione Girante	28.4

**FIAT**
**Brava**

1.9 D	48	10/95 → 10/01	D	160A7.000	(+)COP
-------	----	---------------	---	-----------	--------

**Bravo I**

1.9 D	48	10/95 → 10/01	D	160A7.000	(+)COP
-------	----	---------------	---	-----------	--------

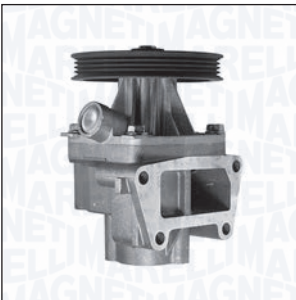
**81343 350981343000**

**PULEGGIA**

Diametro Puleggia	Ø118.5
Numero Denti/Gole Puleggia	4
Posizione Attacco	69.9
Diametro Girante	Ø60
N° Alette Girante	8
Posizione Girante	41.5

**FIAT**
**Fiorino III, Pick Up (Uno)**

1.4	49	05/94 → 05/01	B	146D5.000	(+)COP, M →: 9.470.269
	52	11/92 → 10/96	B	146C5.000	(+)COP, M →: 9.470.269
1.6	55	01/94 → 05/01	B	146C6.000, 146D6.000	(+)COP, M →: 9.470.269
70 i.e. 1.4	49	05/94 → 05/01	B	146C5.000, 146D5.000	(+)COP, M →: 9.470.269
75 i.e. 1.6	55	10/93 → 05/01	B	146C6.000, 146D6.000	(+)COP, M →: 9.470.269

**Palio I, Weekend**

1.4	51	04/96 →	B	178B2.000	(+)COP, (-)SS
1.4 Cat.	51	04/96 →	B	178B2.016	(+)COP, (-)SS

**Siena I**

1.4	51	04/96 → 12/09	B	178B2.000	(+)COP, (-)AC, (-)SS
1.4 Cat.	51	04/96 → 12/09	B	178B2.016	(+)COP, (-)AC, (-)SS

**Tempra, Station Wagon**

1.4 i.e.	51	03/92 → 08/96	B	160A1.046, 836A4.000	(+)COP, M →: 9.336.693, (-)SS
	57	03/91 → 08/96	B	159A2.000	(+)COP, M →: 9.336.693, (-)SS

**Uno I**

1.4	51	07/91 → 07/96	B	160A1.046	(+)COP
	74	01/89 → 12/91	B	146A8.000	(+)COP

**INNOCENTI**
**Elba**

1.4 i.e.	49	09/94 → 12/96	B	146C5.000, 146D5.000	(+)COP, 03-1995 →
----------	----	---------------	---	-------------------------	----------------------

**81344**
**350981344000**

**FLANGIA**

Numero Fori Flangia	3
Posizione Attacco	Ø1.5
Diametro Mozzo	Ø23
Diametro Centraggio	Ø26
Diametro Girante	n.v.
N° Alette Girante	n.v.
Posizione Girante	n.v.

**KW**

**FIAT**
**Elba**

1.7 D	43	04/89 → 12/96	D	146B2.000	(+)SS, (+)AC
-------	----	---------------	---	-----------	--------------

**Fiorino III, Pick Up (Uno)**

1.7 D	42	10/93 → 10/99	D	146B2.000	(+)SS, (+)AC
	44	01/88 → 10/99	D	146B2.000	(+)SS, (+)AC
	44	05/88 → 10/99	D	149B3.000	(+)SS, (+)AC

1.7 TD	46	11/96 → 05/00	D	146D7.000	
	46	01/97 → 05/01	D	146D7.000	

60 1.7 D	42	05/88 → 10/96	D	146B2.000	(+)SS, (+)AC
	44	05/88 → 05/00	D	149B3.000	(+)SS, (+)AC

65 1.7 TD	46	01/97 → 05/01	D	146D7.000	
-----------	----	---------------	---	-----------	--

**INNOCENTI**
**Elba**

1.7 D	42	08/91 → 12/96	D	146B2.000	(+)SS, (+)AC
-------	----	---------------	---	-----------	--------------

**81346**
**350981346000**

**PULEGGIA**

Diametro Puleggia	Ø118.5
Numero Denti/Gole Puleggia	7
Posizione Attacco	77
Diametro Girante	Ø60
N° Alette Girante	8
Posizione Girante	41.5

**KW**

**CITROËN**
**Jumpy I**

1.6	58	10/95 →	B	1580SPI, 220A2.000	(+)COP
	59	10/95 → 08/00	B	220A2.000	(+)COP

1.6 i	58	10/95 →	B	1580SPI, 220A2.000	(+)COP, 10-1995 →
-------	----	---------	---	--------------------	-------------------

--	--	--	--	--	--

--	--	--	--	--	--

--	--	--	--	--	--

--	--	--	--	--	--

--	--	--	--	--	--

1.6	58	02/96 → 12/06	B	220A2.000	(+)COP
-----	----	---------------	---	-----------	--------

**81346**
**350981346000**

**KW**

**PEUGEOT**
**Expert I**

1.6	58	02/96 →	B	222A2 (1580SPI)	(+)COP
-----	----	---------	---	-----------------	--------

**81347**
**350981347000**

**FLANGIA**

Numero Fori Flangia	3
Dimensione Fori Flangia	M8×1.25
Posizione Attacco	78.5
Diametro Mozzo	Ø22
Diametro Centraggio	Ø25.95
Diametro Girante	Ø70
N° Alette Girante	9
Posizione Girante	28.4

**KW**

**ALFA ROMEO**
**145**

1.9 TD	66	10/94 → 02/99	D	AR33601, AR67501	(+)COP, 10-1996 →, → 02-1999
--------	----	---------------	---	------------------	------------------------------

**146**

1.9 TD	66	12/94 → 02/99	D	AR33601, AR67501	(+)COP, 10-1996 →, → 02-1999
--------	----	---------------	---	------------------	------------------------------

**155**

1.9 TD	66	04/93 → 12/97	D	AR67501	(+)COP, 02-1996 →, → 12-1997
--------	----	---------------	---	---------	------------------------------

**FIAT**
**Tempra, Station Wagon**

1.9 D	48	07/91 → 08/96	D	149A1.000, 160A7.000	(+)COP
-------	----	---------------	---	----------------------	--------

**Tipo I**

1.7 D	43	01/88 → 10/94	D	149B4.000	(+)COP, 01-1993 →
-------	----	---------------	---	-----------	-------------------

1.7 D	45	01/88 → 10/95	D	149B4.000	(+)COP, 01-1993 →
-------	----	---------------	---	-----------	-------------------

1.9 D	48	07/91 → 08/95	D	149A1.000, 160A7.000	(+)COP, 01-1993 →
-------	----	---------------	---	----------------------	-------------------

**LANCIA**
**Dedra, Station Wagon**

1.9 TDS	66	07/94 → 07/99	D	160D1.000, 835A4.000	(+)COP
---------	----	---------------	---	----------------------	--------

**81347 350981347000**

**LANCIA**
**Dedra, Station Wagon**

1.9 TDS	66	04/89 → 07/99	D	160D1.000, 835A4.000, 835A4.046	(+)COP, 05-1994 →
---------	----	---------------	---	---------------------------------------	----------------------

**Delta II**

1.9 TD	66	10/94 → 08/99	D	160D1.000, 835A4.000	(+)COP
--------	----	---------------	---	-------------------------	--------

**81348 350981348000**

**PULEGGIA**

Diametro Puleggia	Ø68
Altezza Puleggia	30.5
Posizione Attacco	38.75
Diametro Girante	Ø76
N° Alette Girante	8
Posizione Girante	17.2

**ALFA ROMEO**
**145**

1.6 16V T.S.	82	09/97 → 12/00	B	AR32102
1.6 i.e. 16V T.S.	88	12/96 → 01/01	B	AR38201, AR67601

**146**

1.6 16V T.S.	82	09/97 → 12/00	B	AR32102
1.6 i.e. 16V T.S.	88	11/96 → 01/01	B	AR38201, AR67601

**155**

1.6 16V T.S.	88	05/96 → 12/97	B	AR67601	05-1996 →
1.7 T.S. 16V	103	05/96 → 12/97	B	AR67106	05-1996 →

**156, Sportwagon**

1.6 16V T.SPARK	82	09/97 → 09/05	B	AR32102	11-1997 →, → 04-2000
	88	09/97 → 09/05	B	AR32102, AR32103, AR32104, AR67601	
1.8 16V T.SPARK	103	10/00 → 09/05	B	AR32205	
	106	09/97 → 10/00	B	AR32201	

**GT II**

1.8 TS	103	11/03 → 09/10	B	AR32205
--------	-----	---------------	---	---------

**81348 350981348000**

**FIAT**
**Barchetta**

1.8 16V	96	04/95 → 05/05	B	183A1.000, 188A6.000	09-2000 →
---------	----	---------------	---	-------------------------	-----------

**Punto II, Cabrio, Van**

1.8 130 HGT	96	09/99 →	B	183A1.000, 188A6.000	09-2000 →, M: 188 A6.000
-------------	----	---------	---	-------------------------	-----------------------------

**Stilo, Station Wagon**

1.8 16V	98	01/03 → 08/08	B	192A4.000
	98	10/01 → 11/06	B	192A4.000

**81351 350981351000**

**PULEGGIA**

Diametro Puleggia	Ø60.5
Altezza Puleggia	26
Posizione Attacco	33.2
Diametro Girante	Ø66
N° Alette Girante	8
Posizione Girante	17.2

**FIAT**
**Brava**

1.4	55	10/95 → 10/01	B	182A5.000	01-1998 →, M →: 705.145
1.4 12 V	59	10/95 → 08/98	B	182A3.000	01-1998 →, M →: 705.145

**Bravo I**

1.4	55	10/95 → 10/01	B	182A5.000	01-1998 →, M →: 705.145
1.4	59	10/95 → 10/01	B	182A3.000	01-1998 →, M →: 705.145

**Marea, Weekend**

1.4 80 12V	59	09/96 → 05/02	B	182A3.000	01-1998 →, M →: 705.145
------------	----	---------------	---	-----------	----------------------------

**LANCIA**
**Y**

1.4 12V	55	03/96 → 09/03	B	840A4.000	M →: 705.145
1.4 12V	59	10/96 → 09/03	B	840A2.000	M →: 705.145

81352

350981352000



**PULEGGIA**

Diametro Puleggia	Ø48
Altezza Puleggia	34
Posizione Attacco	41.2
Diametro Girante	Ø76
N° Alette Girante	8
Posizione Girante	17.2



KW



**ALFA ROMEO**

**145**

1.9 JTD	77	02/99 → 01/01	D	AR32302
---------	----	---------------	---	---------

**146**

1.9 JTD	77	02/99 → 01/01	D	AR32302
---------	----	---------------	---	---------

**147**

1.9 JTD	74	06/03 → 03/10	D	182B9.000
	81	11/00 → 09/04	D	AR37101
	85	04/01 → 03/10	D	937A2.000
1.9 JTDM	85	10/04 → 03/10	D	939A7.000
1.9 JTDM 8V	88	07/05 → 03/10	D	937A3.000

**156, Sportwagon**

1.9 JTD	77	09/97 → 10/00	D	AR32302
	81	10/00 → 05/01	D	AR37101
	85	05/01 → 09/05	D	937A2.000
2.4 JTD	100	09/97 → 09/03	D	AR32501
	103	10/00 → 09/05	D	839A6.000
	110	03/02 → 09/05	D	841C000

**159, Sportwagon**

1.9 JTDM 8V	85	03/06 → 11/11	D	937A7.000
	85	09/05 → 11/11	D	937A7.000, 939A7.000
	88	09/05 → 11/11	D	939A1.000

**166**

2.4 JTD	110	04/02 → 06/07	D	841C000
	100	09/98 → 10/00	D	AR34202
	103	10/00 → 06/07	D	839A6.000

**FIAT**

**Brava**

1.9 JTD 105	77	12/98 → 10/01	D	182B4.000
1.9 TD 75 S	55	03/96 → 10/01	D	182A8.000 09-1996 →

**Bravo I**

1.9 JTD 105	77	12/98 → 10/01	D	182B4.000
1.9 TD 75 S	55	03/96 → 10/01	D	182A8.000 09-1996 →

81352

350981352000



KW



**Bravo II, Van**

1.9 D Multijet	66	04/07 → 12/08	D	192B5.000
	85	11/06 →	D	192A1.000, 192B4.000
	88	04/07 →	D	192A8.000

**Croma II**

1.9 D Multijet	85	06/05 →	D	939A7.000
	88	06/05 →	D	939A1.000

**Doblò I, Cargo**

1.9 D	46	03/01 →	D	223A6.000
1.9 D Multijet	88	10/05 →	D	186A9.000
1.9 JTD	77	07/03 →	D	223A7.000, 223B1.000
	74	10/01 →	D	182B9.000
	74	10/01 →	D	182B9.000, 223B2.000
1.9 JTD Multijet	88	12/06 →	D	186A9.000

**Grande Punto, Van**

1.9 D Multijet	88	10/05 →	D	939A1.000
	96	10/05 →	D	199A5.000

**Idea**

1.9 JTD	74	01/04 →	D	188B2.000
---------	----	---------	---	-----------

**Marea, Weekend**

1.9 JTD 105	77	04/99 → 01/01	D	182B4.000
1.9 JTD 110	81	01/01 → 05/02	D	186A6.000
1.9 TD 75	55	09/96 → 05/02	D	182A8.000 05-1999 →
2.4 JTD 130	96	04/99 → 05/02	D	185A6.000, 839A5.000

**Multipia**

1.9 JTD	88	04/02 → 06/10	D	186A9.000
1.9 JTD 105	77	04/99 → 06/10	D	182B4.000
1.9 JTD 110	81	03/01 → 07/02	D	186A6.000
1.9 JTD 115	85	07/02 → 06/10	D	186A8.000

**Palio I, Weekend**

1.9 D	46	03/01 →	D	223A6.000
1.9 JTD	59	09/01 →	D	188A2.000

**Punto II, Cabrio, Van**

1.9 D 60	44	02/00 → 10/09	D	188A3.000
1.9 DS 60	44	09/99 →	D	188A3.000
1.9 JTD	63	10/01 →	D	188A7.000
	74	06/03 →	D	188B2.000
1.9 JTD 80	59	09/99 →	D	188A2.000

**81352 350981352000**

**FIAT**
**Sedici**

1.9 D Multijet	88	06/06 →	D	D19AA	
1.9 D Multijet 4x4	88	06/06 →	D	D19AA	

**Siena I**

1.9 D	46	11/00 →	D	223A6.000	
-------	----	---------	---	-----------	--

**Stilo, Station Wagon**

1.9 D	66	09/04 → 08/08	D	192B5.000	
1.9 D	74	09/05 → 11/06	D	192A9.000	
Multijet	88	09/05 → 11/06	D	192A8.000	
1.9 JTD	59	01/03 → 08/08	D	192A3.000	
	85	01/03 → 08/08	D	192A1.000, 937A7.000	
	59	02/02 → 11/06	D	192A3.000	
	66	09/04 → 11/06	D	192B5.000	
	85	10/01 → 11/06	D	192A1.000, 937A7.000	

**Strada**

1.9 D	46	12/00 →	D	223A6.000	
1.9 JTD	59	04/03 →	D	188A2.000	

**LANCIA**
**Kappa, Station Wagon, Coupé**

2.4 JTD	100	06/98 → 10/01	D	838A8.000	
2.4 T.DS	91	08/94 → 10/01	D	838A3.000, 838A7.000	09-1997 →, M →: 727.391

**Lybra, Station Wagon**

1.9 JTD	85	05/01 → 10/05	D	937A2.000	
	77	07/99 → 09/00	D	AR32302	
	81	09/00 → 05/01	D	AR37101	
2.4 JTD	110	05/02 → 10/05	D	841C.000	
	99	07/99 → 02/01	D	839A5.000, AR32501	
	103	09/00 → 05/02	D	839A6.000	

**Musa**

1.9 D Multijet	74	10/04 → 09/12	D	188B2.000	
----------------	----	---------------	---	-----------	--

**Thesis**

2.4 JTD	110	07/02 → 07/09	D	841C.000	
---------	-----	---------------	---	----------	--

**OPEL**
**Astra H, Station Wagon, GTC, Twin Top, Van**

1.9 CDTI	74	09/05 →	D	Z19DTL	
	88	06/04 →	D	Z19DT	

**Signum**

1.9 CDTI	74	08/05 →	D	Z19DT	
	88	04/04 →	D	Z19DT	

**81352 350981352000**

**OPEL**
**Vectra C, Station Wagon**

1.9 CDTI	74	10/05 →	D	Z19DT	
	74	10/05 →	D	Z19DTL	
	88	04/04 →	D	Z19DT	

**Zafira B, Van**

1.9 CDTI	74	07/05 →	D	Z19DTL	
	88	07/05 →	D	Z19DT	

**SAAB**
**9-3 II, Station Wagon, Cabrio**

1.9 TiD	88	09/04 →	D	Z19DT	
---------	----	---------	---	-------	--

**SUZUKI**
**SX4**

1.9 DDiS	88	06/06 →	D	D19AA	
1.9 DDiS 4x4	88	06/06 →	D	D19AA	

**81353 350981353000**

	<b>PULEGGIA</b> Diametro Puleggia Ø59.26 Numero Denti/Gole Puleggia 20 Altezza Puleggia 33.5 Posizione Attacco 64.6 Diametro Girante Ø74 N° Alette Girante 8 Posizione Girante 20.25	
--	---	--

**CITROËN**
**Evasion**

2.1 TD	80	05/96 → 07/02	D	P8C (XUD11BTE)	06-1996 →
--------	----	---------------	---	----------------	-----------

**Xantia I, Break**

2.1 Turbo D 12V	80	06/95 → 01/98	D	P8C (XUD11BTE)	06-1995 →
	80	06/96 → 01/98	D	P8C (XUD11BTE)	11-1996 →

**Xantia II, Break**

2.1 Turbo D 12V	80	01/98 → 02/99	D	P8C (XUD11BTE)	11-1996 →
-----------------	----	---------------	---	----------------	-----------

**81353**
**350981353000**

**KW**

**CITROËN**
**XM I, Break**

2.1 TD 12V	80	11/91 → 04/94	D	P8A (XUD11ATE), P8C (XUD11BTE), PHZ (XUD11ATE), PJZ (XUD11ATE)	01-1991 →, → 07-1994
	80	05/89 → 06/94	D	P8A (XUD11ATE), PHZ (XUD11ATE), PJZ (XUD11ATE)	05-1989 →, → 07-1994

**XM II, Break**

2.1 TD 12V	80	05/94 → 10/00	D	P8A (XUD11ATE), P8C (XUD11BTE), PHZ (XUD11ATE), PJZ (XUD11ATE)	01-1994 →
	80	05/94 → 10/00	D	P8C (XUD11BTE), PHZ (XUD11ATE), PJZ (XUD11ATE)	01-1993 →

**FIAT**
**Ulysse I**

2.1 TD	80	03/96 → 10/99	D	P8C	04-1996 →
--------	----	---------------	---	-----	-----------

**LANCIA**
**Zeta**

2.1 TD	80	05/96 → 09/99	D	P8C	
--------	----	---------------	---	-----	--

**PEUGEOT**
**407, Station Wagon, Coupé**

2.1 TD 12V	80	01/96 → 05/04	D	P8C (XUD11BTE)	
------------	----	---------------	---	-------------------	--

**605**

2.1 TD 12V	80	08/94 → 09/99	D	P8C (XUD11BTE)	
------------	----	---------------	---	-------------------	--

 2.1 Turbo  
Diesel

80	06/89 → 09/99	D	PHZ (XUD11ATE)	
----	---------------	---	-------------------	--

**806**

2.1 td 12V	80	06/96 → 08/99	D	P8C (XUD11BTE)	
------------	----	---------------	---	-------------------	--

**81355**
**350981355000**

**KW**

**FLANGIA**

Numero Fori Flangia	3
Dimensione Fori Flangia	M6×1
Posizione Attacco	66.5
Diametro Centraggio	Ø48
Diametro Girante	Ø67.5
N° Alette Girante	7
Posizione Girante	9.7

**KW**

**ALFA ROMEO**
**147**

3.2 GTA	184	02/03 → 03/10	B	932A.000	
---------	-----	---------------	---	----------	--

**156, Sportwagon**

2.5 V6 24V	140	05/00 → 08/03	B	AR32401	
	140	09/97 → 12/01	B	AR32401, AR32402	11-1997 →
	141	10/00 → 09/05	B	AR32405	
3.2 GTA	184	03/02 → 09/05	B	932A.000	

**166**

2.0 V6	151	09/98 → 10/00	B	AR34102	
2.5 V6 24V	138	10/00 → 06/07	B	AR36201	
	140	09/98 → 10/00	B	AR34201	
3.0 V6 24V	162	10/00 → 06/07	B	AR36101	
	166	09/98 → 10/00	B	AR34301, AR34302	
3.2 V6 24V	176	10/03 → 06/07	B	936A.000	M: AR34301/36101

**GT II**

3.2 GTA	176	11/03 → 09/10	B	936A.000	
---------	-----	---------------	---	----------	--

**GTV II**

3.0 V6 24V	162	10/96 → 10/00	B	AR16102	
3.2 V6 24V	176	04/03 → 10/05	B	936A6.000	M: AR16102

**Spider IV**

3.0 V6 24V	162	01/99 → 10/03	B	AR16102	
3.2 V6 24V	176	04/03 → 04/05	B	936A6.000	

**LANCIA**
**Kappa, Station Wagon, Coupé**

3.0 24V	150	08/94 → 10/01	B	838B.000	
---------	-----	---------------	---	----------	--

**Thesis**

3.0 V6	158	07/02 → 07/09	B	841A.000	
	169	05/03 → 07/09	B	841L.000	

**81362**
**350981362000**

FLANGIA	
Numero Fori Flangia	3
Numero Fori Flangia (Serie 2)	3
Dimensione Fori Flangia	M8×1.25
Dimensione Fori Flangia (Serie 2)	M7×1
Posizione Attacco	73.8
Diametro Mozzo	Ø36
Diametro Girante	Ø70.5
N° Alette Girante	7
Posizione Girante	29

**KW**

**ALFA ROMEO**
**164**

2.5 TD	92	09/92 → 09/98	D	VM08B, VM32B	(-)COP
--------	----	---------------	---	-----------------	--------

**CHRYSLER**
**Voyager III**

2.5 TD	85	01/95 → 03/01	D	425CLIRS/X, ENC	(-)COP
--------	----	---------------	---	--------------------	--------

**FORD**
**Scorpio II, Station Wagon**

2.5 TD	92	09/96 → 08/98	D	VM	(-)COP
--------	----	---------------	---	----	--------

**JEEP**
**Cherokee II (XJ)**

2.5	89	10/95 → 09/01	B	EPE	(-)COP
-----	----	---------------	---	-----	--------

2.5 TD	85	01/88 → 09/01	D	ENC	(-)COP
--------	----	---------------	---	-----	--------

**Grand Cherokee I**

2.5 TD 4x4	85	10/95 → 04/99	D	M51, M52	(-)COP
------------	----	---------------	---	----------	--------

2.5 TD Laredo	85	10/96 → 09/98	D		(-)COP
------------------	----	---------------	---	--	--------

**Grand Cherokee II**

3.1 TD 4x4	103	04/99 → 12/01	D	EXA	(-)COP
------------	-----	---------------	---	-----	--------

**OPEL**
**Frontera A**

2.5 TDS	85	09/96 → 10/98	D	25TDS (VM41B)	(-)COP
---------	----	---------------	---	------------------	--------

**ROVER**
**800**

825 D/SD	87	01/90 → 02/99	D	425SL1RR, 4924SHIRG	(-)COP, 03-1996 →
----------	----	---------------	---	------------------------	----------------------

825 SD	87	09/93 → 02/99	D	425SL1RR, 4924SHIRG	(-)COP, 03-1996 →
--------	----	---------------	---	------------------------	----------------------

**81363**
**350981363000**

FLANGIA	
Numero Fori Flangia	3
Dimensione Fori Flangia	M8×1.25
Posizione Attacco	78.5
Diametro Mozzo	Ø22
Diametro Centraggio	Ø25.95
Diametro Girante	Ø70
N° Alette Girante	9
Posizione Girante	28.4

**KW**

**ALFA ROMEO**
**145**

1.9 TD	66	10/94 → 02/99	D	AR33601, AR67501	(-)COP, 10-1996 →, → 02-1999
--------	----	---------------	---	---------------------	------------------------------------

**146**

1.9 TD	66	12/94 → 02/99	D	AR33601, AR67501	(-)COP, 10-1995 →
--------	----	---------------	---	---------------------	----------------------

**155**

1.9 TD	66	04/93 → 12/97	D	AR67501	(-)COP, 02-1996 →, → 12-1997
--------	----	---------------	---	---------	------------------------------------

**FIAT**
**Tempra, Station Wagon**

1.9 D	48	07/91 → 08/96	D	149A1.000, 160A7.000	(-)COP
-------	----	---------------	---	-------------------------	--------

**Tipo I**

1.7 D	43	01/88 → 10/94	D	149B4.000	(-)COP, 01-1993 →
-------	----	---------------	---	-----------	----------------------

	45	01/88 → 10/95	D	149B4.000	(-)COP, 01-1993 →
--	----	---------------	---	-----------	----------------------

1.9 D	48	07/91 → 08/95	D	149A1.000, 160A7.000	(-)COP, 01-1993 →
-------	----	---------------	---	-------------------------	----------------------

**LANCIA**
**Debra, Station Wagon**

1.9 TDS	66	07/94 → 07/99	D	160D1.000, 835A4.000	(-)COP
---------	----	---------------	---	-------------------------	--------

	66	04/89 → 07/99	D	160D1.000, 835A4.000, 835A4.046	(-)COP, 05-1994 →
--	----	---------------	---	---------------------------------------	----------------------

**Delta II**

1.9 TD	66	10/94 → 08/99	D	160D1.000, 835A4.000	(-)COP
--------	----	---------------	---	-------------------------	--------

81364

350981364000



**PULEGGIA**

Diametro Puleggia Ø118.5 / Ø107  
 Numero Denti/Gole Puleggia 5 / 3  
 Posizione Attacco 84.9  
 Diametro Girante Ø60  
 N° Alette Girante 8  
 Posizione Girante 41.5



KW



**FIAT**

**Brava**

1.6 16V	66	10/95 → 10/01	B	182A6.000	(-)COP
	76	02/96 → 10/01	B	182A4.000	(-)COP
	76	01/99 → 12/02	B	182B6.000	(-)COP

**Bravo I**

1.6	76	09/00 → 10/01	B	182B6.000	(-)COP
1.6 16V	66	10/95 → 10/01	B	182A6.000	(-)COP, 10-1995 →
	76	03/96 → 10/01	B	182A4.000	(-)COP

**Doblò I, Cargo**

1.6	68	09/02 →	B	182B6.000	(-)COP
1.6 16V	76	10/01 →	B	182B6.000	(-)COP
1.6 Natural Power	76	09/02 →		182B6.000	(-)COP

**Marea, Weekend**

1.6	68	03/99 → 08/00	B	185A3.000	(-)COP
	76	09/00 → 08/02	B	182B6.000	(-)COP
1.6 100 16V	76	09/96 → 05/02	B	182A4.000	(-)COP
1.6 100 16V Bipower	76	04/99 → 05/02		185A3.000, 186A4.000	(-)COP
1.6 16V	75	04/97 → 02/99	B	185A3.000	(-)COP
1.6 SX	72	09/00 → 08/02	B	182B5.098	(-)COP

**Multipla**

1.6	68	05/04 → 08/05	G	182B6.000	(-)COP
	74	03/01 → 08/05	G	182B6.000	(-)COP
	76	09/00 → 06/10	B	182B6.000	(-)COP
1.6 100 16V	76	04/99 → 06/10	B	182A4.000	(-)COP
1.6 16V	70	04/02 → 06/10	B	182B6.000	(-)COP
1.6 16V Bipower	76	04/99 → 06/10		186A4.000	(-)COP
	76	10/01 → 06/10		182B6.000	(-)COP
1.6 16V Blupower	70	04/99 → 06/10	G	186A3.000	(-)COP

**Palio I, Weekend**

1.5	62	02/02 →	B	178E5.022	(-)COP
1.6	68	07/97 → 10/03	B	178C7.098, 178D2.011	(-)COP

81364

350981364000



KW



**FIAT**

**Palio I, Weekend**

1.6 16V	74	04/96 →	B	178B3.000	(-)COP
	74	04/96 → 02/01	B	178B3.000	(-)COP, 07-1997 →
	76	02/01 →	B	182B6.000	(-)COP

**Siena I**

1.5 Bipower	57	09/03 → 12/05	BF	178A6.011	(-)COP
1.6	76	11/00 → 12/09	B	182B6.000	(-)COP
1.6 16V	78	09/98 → 12/09	B	178B3.000	(-)COP

**Stilo, Station Wagon**

1.6 16V	76	01/03 → 08/08	B	182B6.000	(-)COP
	77	05/05 → 11/06	B	192B3.000	(-)COP
	76	10/01 → 11/06	B	182B6.000	(-)COP

**LANCIA**

**Delta II**

1.6 i.e.	66	03/96 → 08/99	B	182A6.000	(-)COP
1.6 i.e. 16V	76	01/96 → 08/99	B	182A4.000	(-)COP

**Lybra, Station Wagon**

1.6	76	10/00 → 10/05	B	182B6.000	(-)COP
1.6 16V	76	07/99 → 10/05	B	182A4.000, 182B6.000	(-)COP

81365

350981365000



**FLANGIA**

Numero Fori Flangia 3  
 Dimensione Fori Flangia M8x1.25  
 Posizione Attacco 61.55  
 Diametro Mozzo Ø22  
 Diametro Centraggio Ø25.95  
 Diametro Girante Ø70  
 N° Alette Girante 9  
 Posizione Girante 28.4



KW



**FIAT**

**Punto I, Cabrio, Van**

1.7 TD	51	01/94 → 09/99	D	176A3.000	(-)COP, → 08-1996
	52	01/94 → 09/99	D	176A5.000	(-)COP, → 08-1996

**Palio I, Weekend**

1.7 TD	51	04/96 → 03/01	D	176A3.000	(-)COP, → 09-1999, → M: 2.427.906
--------	----	---------------	---	-----------	-----------------------------------



**81365 350981365000**

**FIAT**
**Punto I, Cabrio, Van**

1.7 D	42	04/96 → 02/00	D	176B3.000	(-)COP
1.7 TD	52	04/96 → 02/00	D	176A5.000	(-)COP

**Strada**

1.7 TD	51	06/99 →	D	176A3.000	(-)COP, → M: 2.427.906
--------	----	---------	---	-----------	---------------------------

**JEEP**
**Wrangler II**

2.4	105	11/02 → 04/07	B	ED1	(-)COP
-----	-----	---------------	---	-----	--------

**81366 350981366000**

**PULEGGIA**

Diametro Puleggia Ø118.5

Numero Denti/Gole Puleggia 4

Posizione Attacco 69.9

Diametro Girante Ø60

N° Alette Girante 8

Posizione Girante 41.5

**FIAT**
**Fiorino III, Pick Up (Uno)**

1.4	49	05/94 → 05/01	B	146D5.000	(-)COP, M →: 9.470.269
	52	11/92 → 10/96	B	146C5.000	(-)COP, M →: 9.470.269
1.6	55	01/94 → 05/01	B	146C6.000, 146D6.000	(-)COP, M →: 9.470.269
70 i.e. 1.4	49	05/94 → 05/01	B	146C5.000, 146D5.000	(-)COP, M →: 9.470.269
75 i.e. 1.6	55	10/93 → 05/01	B	146C6.000, 146D6.000	(-)COP, M →: 9.470.269

**Palio I, Weekend**

1.4	51	04/96 →	B	178B2.000	(-)COP, (-)SS
1.4 Cat.	51	04/96 →	B	178B2.016	(-)COP, (-)SS

**Siena I**

1.4	51	04/96 → 12/09	B	178B2.000	(-)COP, (-)JAC, (-)SS
1.4 Cat.	51	04/96 → 12/09	B	178B2.016	(-)COP, (-)JAC, (-)SS

**81366 350981366000**

**FIAT**
**Tempra, Station Wagon**

1.4 i.e.	51	03/92 → 08/96	B	160A1.046, 836A4.000	(-)COP, M →: 9.336.693, (-)SS
	57	03/91 → 08/96	B	159A2.000	(-)COP, M →: 9.336.693, (-)SS

**Uno I**

1.4	51	07/91 → 07/96	B	160A1.046	(-)COP
	74	01/89 → 12/91	B	146A8.000	(-)COP

**INNOCENTI**
**Elba**

1.4 i.e.	49	09/94 → 12/96	B	146C5.000, 146D5.000	(-)COP, 03-1995 →
----------	----	---------------	---	-------------------------	----------------------

**81367 350981367000**

**ALBERINO**

Diametro Alberino M14×1.5

Tipo Filetto Alberino Maschio

Posizione Attacco 105.5

Diametro Girante Ø56

N° Alette Girante 6

Posizione Girante 21

**CITROËN**
**C 25**

1.8	50	11/81 → 01/94	B	169 (XM7T)	
1.8 E	51	07/87 → 02/94	B	169 (XM7T)	
2.0	62	02/91 → 02/94	B	170C (XN1T)	
2.0 4x4	62	01/90 → 01/94	B		
2.0 E	58	09/81 → 02/94	B	170A (XN1T), 170B (XN1T)	

**FIAT**
**Ducato I**

2.0	55	07/85 → 08/90	B	170B	
	55	07/85 → 08/90	B	170B, XN1T	
	58	01/82 → 08/90	B	XN1T	
	62	03/89 → 08/90	B	170D	

**Ducato II**

2.0	62	07/90 → 03/94	B	170D	
2.0 4x4	63	06/90 → 05/94	B	170D	

**Talento**

2.0	55	03/89 → 03/94	B	170B	
-----	----	---------------	---	------	--

**81367 350981367000**



**PEUGEOT**

**J5 I**

2.0	55	09/81 → 09/90	B	170B (XN1T)	
	55	09/87 → 08/90	B	XN1T	
	58	01/83 → 09/90	B	170 (XN1T)	
	58	09/81 → 08/90	B	XN1P	

**J5 II**

2.0	62	10/90 → 02/94	B	170D (XN1TACP)	09-1981 →, → 01-1994
	62	10/90 → 02/94	B	170D (XN1TACP)	
	62	09/90 → 01/94	B	170D (XN1TACP), XN1TA	

**81368 350981368000**



**PULEGGIA**  
 Diametro Puleggia Ø118.5  
 Numero Denti/Gole Puleggia 7  
 Posizione Attacco 77  
 Diametro Girante Ø60  
 N° Alette Girante 8  
 Posizione Girante 41.5



**CITROËN**

**Jumpy I**

1.6	58	10/95 →	B	1580SPI, 220A2.000	(-)COP
1.6	59	10/95 → 08/00	B	220A2.000	(-)COP
1.6 i	58	10/95 →	B	1580SPI, 220A2.000	(-)COP

**FIAT**

**Scudo I**

1.6	58	02/96 → 12/06	B	220A2.000	(-)COP
-----	----	---------------	---	-----------	--------

**PEUGEOT**

**Expert I**

1.6	58	02/96 →	B	222A2 (1580SPI)	(-)COP
-----	----	---------	---	-----------------	--------

**81369 350981369000**



**PULEGGIA**  
 Versione PIERBURG  
 Diametro Puleggia Ø57  
 Numero Denti/Gole Puleggia 23  
 Altezza Puleggia 23.4  
 Posizione Attacco 53.9  
 Diametro Girante Ø63  
 N° Alette Girante 8  
 Posizione Girante 34.5



**ABARTH**

**500**

1.4	99	08/08 →	B	312A1.000	PIERBURG
-----	----	---------	---	-----------	----------

**Grande Punto**

1.4	114	12/07 → 06/10	B	199A8.000	PIERBURG
	132	12/07 → 12/12	B	199A8.000, 955A8.000	PIERBURG

**ALFA ROMEO**

**Mito**

1.4	58	09/08 →	B	955A1.000	PIERBURG
	70	09/08 →	B	199A6.000	PIERBURG
1.4 TJet	88	09/08 →	B	198A4.000	PIERBURG

**CHRYSLER**

**Delta**

1.4	88	08/11 →	B	198A4.000	PIERBURG
1.4 16V	103	08/11 →	B	198A7.000	PIERBURG

**Ypsilon**

1.2	51	05/11 →	B	169A4.000	PIERBURG
-----	----	---------	---	-----------	----------

**FIAT**

**500 II, 500C**

1.2	51	10/07 →	B	169A4.000	PIERBURG
1.4	74	10/07 →	B	169A3.000	PIERBURG

**Punto I, Cabrio, Van**

1.2 16V	63	04/97 → 09/99	B	176B9.000	PIERBURG
---------	----	---------------	---	-----------	----------

**Brava**

1.2 16V 80	64	12/98 → 12/02	B	182B2.000	PIERBURG
	59	10/00 → 10/01	B	188A5.000	PIERBURG
	60	12/98 → 12/02	B	182B2.000	→ 03-1999
	60	12/98 → 12/02	B	182B2.000	04-1999 →, PIERBURG

**Bravo I**

1.2 16V 80	59	10/00 → 10/01	B	188A5.000	PIERBURG
	60	12/98 → 10/00	B	182B2.000	→ 03-1999
	60	12/98 → 10/00	B	182B2.000	04-1999 →, PIERBURG
	64	12/98 → 10/01	B	182B2.000	PIERBURG

**81369 350981369000**

**FIAT**
**Bravo II, Van**

1.4	66	04/07 →	B	192B2.000	PIERBURG
1.4 T-Jet	88	09/07 →	B	198A4.000	PIERBURG
	110	09/07 →	B	198A1.000	PIERBURG

**Doblò I, Cargo**

1.4	57	10/05 →	B	350A1.000	PIERBURG
-----	----	---------	---	-----------	----------

**Grande Punto, Van**

1.2	48	10/05 →	B	199A4.000	PIERBURG
1.4	57	10/05 →	B	350A1.000	PIERBURG
1.4 16V	70	10/05 →	B	199A6.000	PIERBURG
1.4 Natural Power	57	07/08 →		350A1.000	PIERBURG
1.4 T-Jet	88	09/07 →	B	198A4.000	PIERBURG

**Idea**

1.2 16V	59	01/04 →	B	188A5.000	PIERBURG
1.4	57	10/05 →	B	350A1.000	PIERBURG
	66	12/03 →	B	192B2.000	PIERBURG
1.4 16V	70	01/04 →	B	843A1.000	PIERBURG

**Linea**

1.4	57	06/07 →	B	350A1.000	PIERBURG
1.4 T-Jet	88	09/07 →	B	198A4.000	PIERBURG

**Marea, Weekend**

1.2 16V	60	10/98 → 05/02	B	182B2.000	PIERBURG
---------	----	---------------	---	-----------	----------

**Palio I, Weekend**

1.2	59	09/01 →	B	188A5.000	PIERBURG
-----	----	---------	---	-----------	----------

**Panda I, Van**

1.1	40	09/00 → 02/04	B	187A1.000	M →: 2.533.529, PIERBURG
-----	----	---------------	---	-----------	--------------------------

**Panda II, Van**

1.1	40	09/03 →	B	187A1.000	M →: 2.533.529, PIERBURG
	40	09/04 →	B	187A1.000	PIERBURG
1.2	44	09/03 →	B	188A4.000	M →: 2.533.529, PIERBURG
	44	09/04 →	B	188A4.000	M →: 2.533.529, PIERBURG
1.2 4x4	44	09/04 →	B	188A4.000	M →: 2.533.529, PIERBURG
	44	10/04 →	B	188A4.000	M →: 2.533.529, PIERBURG
1.2 LPG	44	04/09 →		188A4.000	PIERBURG
1.2 Natural Power	44	01/07 → 11/09		188A4.000	PIERBURG
1.4	74	10/06 →	B	169A3.000	PIERBURG

**81369 350981369000**

**FIAT**
**Panda III, Van**

1.2	51	02/12 →	B	169A4.000	PIERBURG
1.2 LPG	51	06/12 →		169A4.000	PIERBURG

**Punto I, Cabrio, Van**

85 16V 1.2	63	04/97 → 06/00	B	176B9.000	PIERBURG
------------	----	---------------	---	-----------	----------

**Punto II, Cabrio, Van**

1.2 16V 80	59	09/99 →	B	188A5.000	PIERBURG
1.2 Bifuel	44	08/07 →	BF	188A4.000	PIERBURG
1.2 Natural Power	44	09/03 →		188A4.000	M →: 2.533.529, PIERBURG
	70	09/03 →	B	843A1.000	PIERBURG
1.4	71	11/05 →	B	199A6.000	PIERBURG

**Punto III, Van**

1.2	49	02/14 →	B	199B9.000	PIERBURG
-----	----	---------	---	-----------	----------

**Qubo**

1.4 Natural Power	57	10/09 →		350A1.000	PIERBURG
-------------------	----	---------	--	-----------	----------

**Siena I**

1.2	59	09/01 → 12/09	B	188A5.000	PIERBURG
-----	----	---------------	---	-----------	----------

**Stilo, Station Wagon**

1.2 16V	59	02/02 → 11/06	B	188A5.000	PIERBURG
1.4 16V	66	03/05 → 11/06	B	192B2.000	PIERBURG
	70	01/04 → 11/06	B	843A1.000	PIERBURG

**FORD**
**KA II**

1.2	51	10/08 →	B	FP4	PIERBURG
-----	----	---------	---	-----	----------

**LANCIA**
**Delta III**

1.4	88	09/08 → 08/14	B	198A4.000	PIERBURG
	110	09/08 → 08/14	B	198A1.000	PIERBURG

**Musa**

1.4	57	09/05 → 09/12	B	350A1.000	PIERBURG
	70	10/04 → 09/12	B	843A1.000	PIERBURG

**Y**

1.2 16V	59	10/00 → 09/03	B	188A5.000	PIERBURG
	63	04/97 → 09/03	B	176B9.000	PIERBURG

**Ypsilon I**

1.2	59	10/03 → 12/11	B	188A5.000	PIERBURG
1.4	57	02/06 → 12/11	B	350A1.000	PIERBURG
1.4 16V	70	10/03 → 12/11	B	843A1.000	PIERBURG

**81370**
**350981370000**

**PULEGGIA**

Versione	MAGMA
Diametro Puleggia	Ø59.24
Numero Denti/Gole Puleggia	24
Altezza Puleggia	16
Posizione Attacco	46.6
Diametro Girante	Ø63
N° Alette Girante	8
Posizione Girante	34.5

**KW**

**FIAT**
**Doblò I, Cargo**

1.2	48	03/01 →	B	223A5.000	MAGMA
-----	----	---------	---	-----------	-------

**Palio I, Weekend**

1.2	44	07/97 → 08/02	B	178B7.045, 178C4.066, 188A4.000	MAGMA
	50	06/99 → 10/00	B	178E2.000	M →: 9.042.883, MAGMA
	50	06/99 → 10/02	B	178E2.000	MAGMA
	52	06/04 →	B	178E9.011	MAGMA
	54	06/98 →	B	176A8.000, 178B5.000, 178E2.000	M →: 9.042.883, MAGMA
	44	02/01 →	B	178C4.066, 188A4.000	M →: 9.042.883, MAGMA
1.2 Flex	44	07/97 → 08/02	B	188A4.000	MAGMA
1.2 LPG	44	07/97 → 08/02	B	188A4.000	MAGMA

**Panda I, Van**

1.1	40	09/00 → 02/04	B	187A1.000	→ M: 2.533.528, MAGMA
-----	----	---------------	---	-----------	--------------------------

**Panda II, Van**

1.1	40	09/03 →	B	187A1.000	→ M: 2.533.528, MAGMA
	40	09/04 →	B	187A1.000	MAGMA
1.2	44	09/03 →	B	188A4.000	→ M: 2.533.528, MAGMA
	44	09/04 →	B	188A4.000	→ M: 2.533.528, MAGMA
1.2 4x4	44	09/04 →	B	188A4.000	→ M: 2.533.528, MAGMA
	44	10/04 →	B	188A4.000	→ M: 2.533.528, MAGMA

**81370**
**350981370000**

**KW**

**FIAT**
**Punto II, Cabrio, Van**

1.2 60	44	02/00 → 10/09	B	188A4.000	MAGMA
	44	09/99 →	B	188A4.000	MAGMA
1.2 Natural Power	44	09/03 →	B	188A4.000	→ M: 2533528, MAGMA

**Seicento, Van**

1.1	40	01/98 → 01/10	B	176B2.000	05-1999 →, M →: 9.042.883, MAGMA
	40	01/98 → 01/10	B	176B2.000, 187A1.000	05-1999 →, M →: 9.042.883, MAGMA

**Siena I**

1.2	44	09/01 → 12/09	B	178C4.066, 188A4.000	MAGMA
	54	09/98 → 12/09	B	178B5.000	07-1999 →, MAGMA

**Strada**

1.2	44	04/03 →	B	188A4.000	MAGMA
-----	----	---------	---	-----------	-------

**Uno I**

1.1	41	01/92 → 06/06	B	160A3.000	MAGMA
	43	10/88 → 06/06	B	146A4.048, 160A3.000	MAGMA

**LANCIA**
**Y**

1.2	44	03/96 → 09/03	B	188A4.000, 840A3.000	09-2000 →, MAGMA
-----	----	---------------	---	-------------------------	---------------------

**Ypsilon I**

1.2	44	10/03 → 12/11	B	188A4.000	MAGMA
-----	----	---------------	---	-----------	-------

**81372**
**350981372000**

**PULEGGIA**

Diametro Puleggia	Ø100
Numero Denti/Gole Puleggia	7
Posizione Attacco	85.25
Diametro Girante	Ø70
N° Alette Girante	9
Posizione Girante	28.4

**KW**

**FIAT**
**Brava**

1.9 D	48	10/95 → 10/01	D	160A7.000	(-)COP
-------	----	---------------	---	-----------	--------

**81372 350981372000**

**FIAT**
**Bravo I**

1.9 D	48	10/95 → 10/01	D	160A7.000	(-)COP
-------	----	---------------	---	-----------	--------

**81415 350981415000**

**PULEGGIA**

Diametro Puleggia	Ø103
Numero Denti/Gole Puleggia	1
Posizione Attacco	163.2
Diametro Girante	Ø53.8
N° Alette Girante	6
Posizione Girante	40.3

**FIAT**
**Panda I, Van**

650	22	01/82 → 07/04	B	141A.000	
900	33	10/80 → 06/94	B	100GL3.000, 146A.000	→ 12-1991

**Uno I**

45 0.9	33	03/83 → 09/92	B	146A.000, 146A1.000	
--------	----	---------------	---	------------------------	--

**SEAT**
**Ibiza I**

0.9	29	08/90 → 05/93	B	09NCA, 146A000	
	32	08/86 → 05/93	B	146A000	09-1984 →, → 12-1992

**Marbella**

0.9	25	08/86 → 12/93	B	08NCA	
	32	07/97 → 10/98	B	08NCB	
	29	01/87 → 12/93	B	09NCA	

0.9 Cat.	29	01/87 → 12/93	B	09NCA, 100GL7000	
	30	11/96 → 10/98	B	08NCB	
	29	01/87 → 12/93	B	09NCB	

**Terra**

0.9	29	02/87 → 12/96	B	09NCA	
0.9 Cat.	29	02/92 → 12/94	B	09NCB	

**81419 350981419000**

**FLANGIA**

Versione	BC
Numero Fori Flangia	4
Dimensione Fori Flangia	1/4"×28 UNF
Posizione Attacco	94
Diametro Mozzo	Ø23.75
Diametro Girante	Ø53.8
N° Alette Girante	6
Posizione Girante	14.5

**AUSTIN**
**Metro**

1.0	30	10/80 → 04/90	B	99H	BC
	33	10/80 → 04/90	B	99H	BC
1.0 Surf HLE	35	10/80 → 04/90	B	99HA65P	BC
1.3	51	10/80 → 04/90	B	12HA83AA	BC
1.3 L,HLE,S	44	10/80 → 04/90	B	12H	BC
1.3 Surf	44	11/85 → 04/90	B	12HC21AA	BC
1.3 Turbo	66	10/83 → 04/90	B	12HA85AA	BC

**Mini**

1000 Mayfair	31	08/82 → 06/93	B	99H997P, 99HA53P, 99HC20P	BC
	30	09/88 → 06/93	B	99HD81	BC

**INNOCENTI**
**Mini**

1.0	27	10/85 → 10/91	B	99H	BC
-----	----	---------------	---	-----	----

**MG**
**Metro**

1300	54	05/82 → 09/90	B		BC
Turbo	69	10/82 → 09/90	B		BC

**ROVER**
**Mini, Cabrio**

1000	30	01/92 → 06/93	B	99HD81	BC
	37	10/92 → 11/00	B	12A2B	BC
	39	01/92 → 04/95	B	12A2D	BC
1300	45	01/91 → 12/91	B	12A2A	BC
	46	09/92 → 04/95	B	12A2E	BC
	46	01/92 → 11/00	B	12A2E, 12A2L	BC

81434

350981434000



<b>FLANGIA</b>	
Numero Fori Flangia	3
Dimensione Fori Flangia	M8×1.25
Posizione Attacco	56.8
Diametro Mozzo	Ø23
Diametro Centraggio	Ø26
Diametro Girante	Ø62
N° Alette Girante	7
Posizione Girante	44



**AUTOBIANCHI**

**Y10**

1.0	41	03/85 → 10/95	B	156A.000
1.0 Turbo	63	03/85 → 10/95	B	156A1.000
1.3 i.e. GT	54	06/89 → 10/95	B	146A5.046
	57	06/89 → 10/95	B	156B.000

**FIAT**

**Duna I, Weekend**

60 1.1	43	01/87 → 12/91	B	146A6.000
70 1.3	49	01/87 → 12/91	B	146A5.000

**Elba**

1.3	43	04/86 → 12/93	B	127A2.011
1.3 D	33	04/86 → 10/92	D	127A5.000

**Fiorino II, Pick Up (147)**

1.3	49	12/87 → 08/93	B	146A5.000
-----	----	---------------	---	-----------

**Fiorino III, Pick Up (Uno)**

1.3	49	01/88 → 12/94	B	146A5.000
60 1.1	40	05/88 → 12/93	B	146A9.000
70 1.3	49	01/88 → 12/94	B	146A5.000

**Panda I, Van**

1300 D	27	04/86 → 12/92	D	156A5.000
--------	----	---------------	---	-----------

**Uno I**

1.3 Super Diesel	33	06/83 → 03/92	D	127A5.000, 146B1.000
55 1.0	41	11/93 → 08/00	B	146C4.011

**INNOCENTI**

**Elba**

1.3	49	08/91 → 12/96	B	146A5.000
-----	----	---------------	---	-----------

**LANCIA**

**Y10**

1.3 i.e.	53	02/89 → 12/95	B	146A5.046, 156B.000
	56	11/87 → 05/93	B	156B.000

81436

350981436000



<b>FLANGIA</b>	
Numero Fori Flangia	3
Dimensione Fori Flangia	M8×1.25
Posizione Attacco	65.5
Diametro Centraggio	Ø25.95
Diametro Girante	Ø68
N° Alette Girante	12
Posizione Girante	17



**FIAT**

**Regata, Weekend**

100 Super 1.6	74	10/83 → 12/90	B	149A2.000, 149A4.000
---------------	----	---------------	---	----------------------

**LANCIA**

**Delta I**

1.6 GT i.e.	66	05/87 → 08/92	B	149C2.000
1.6 HF Turbo	122	08/86 → 05/93	B	

**Prisma**

1.6	73	08/86 → 02/92	B	831B6.000
-----	----	---------------	---	-----------

81443

350981443000

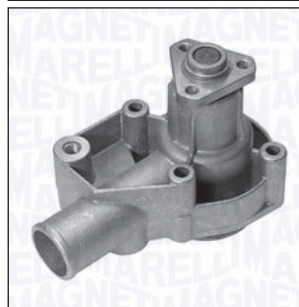

<b>FLANGIA</b>	
Numero Fori Flangia	3
Dimensione Fori Flangia	M8×1.25
Posizione Attacco	95.5
Diametro Mozzo	Ø23
Diametro Centraggio	Ø26
Diametro Girante	Ø68
N° Alette Girante	12
Posizione Girante	17



**ALFA ROMEO**

**164**

2.0 Turbo	128	10/87 → 09/98	B	AR06476
	129	02/88 → 10/92	B	AR06476

**FIAT**

**Croma I**

2000 CHT	74	01/91 → 09/92	B	154A1.000, 154C5.000	
2000 i.e.	83	03/86 → 09/90	B	834B.048	08-1986 →, → T: 285.921
	85	10/87 → 08/96	B	154C3.046, 834B.146	→ T: 285.921
	88	03/87 → 09/92	B	154C3.000, 834B.000	→ T: 285.921

**81443 350981443000**

**FIAT**
**Croma I**

2000 i.e. Turbo	110	06/87 → 08/96	B	154C4.046, 834C.146	→ 02-1991, → T: 285.921
	114	12/85 → 06/90	B	154A2.000	

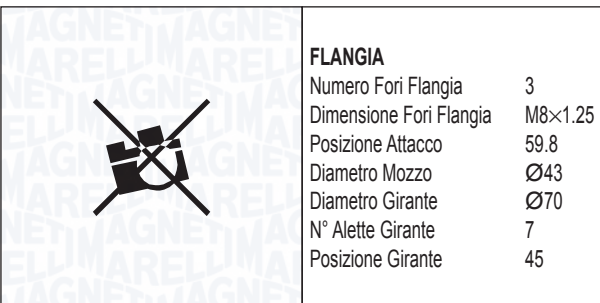
**81450 350981450000**

**FIAT**
**Uno I**

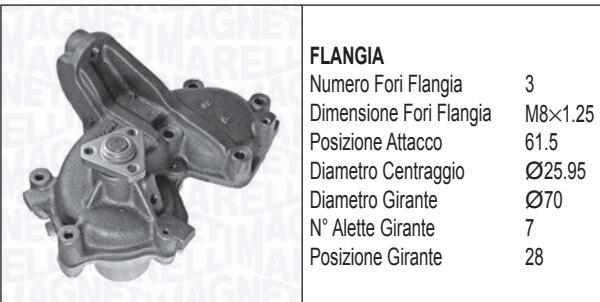
70 TD 1.4	52	10/86 → 10/90	D	146B.000, 146B3.000	(+)COP, → 12-1989, M: 146B.000
-----------	----	---------------	---	------------------------	--------------------------------------

**81456 350981456000**

**FIAT**
**Duna I, Weekend**

1.7 DS	44	01/87 → 12/91	D	149B3.000	(+)COP
--------	----	---------------	---	-----------	--------

**Elba**

1.7 D	43	04/89 → 12/96	D	146B2.000	(+)COP, (-)SS, (-)AC
-------	----	---------------	---	-----------	-------------------------

**Fiorino II, Pick Up (147)**

1.7 D	42	01/88 → 10/93	D	149B2.000	(+)COP
	44	12/87 → 12/90	D	149B3.000	(+)COP

**81456 350981456000**

**FIAT**
**Fiorino III, Pick Up (Uno)**

1.7 D	42	10/93 → 10/99	D	146B2.000	(+)COP, (-)SS, (-)AC
	44	01/88 → 10/99	D	146B2.000	(+)COP, (-)SS, (-)AC
	44	05/88 → 10/99	D	149B3.000	(+)COP, (-)SS, (-)AC
60 1.7 D	42	05/88 → 10/96	D	146B2.000	(+)COP, (-)SS, (-)AC
	44	05/88 → 05/00	D	149B3.000	(+)COP, (-)SS, (-)AC

**INNOCENTI**
**Elba**

1.7 D	42	08/91 → 12/96	D	146B2.000	(+)COP, (-)SS, (-)AC
-------	----	---------------	---	-----------	-------------------------

**81458 350981458000**

**FIAT**
**Panda I, Van**

750	25	01/86 → 07/92	B	141B.000	
	25	01/86 → 01/95	B	141B.000	

81460

350981460000

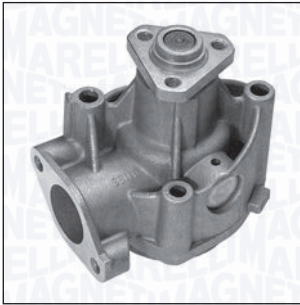

<b>FLANGIA</b>	
Numero Fori Flangia	3
Dimensione Fori Flangia	M8x1.25
Posizione Attacco	95.5
Diametro Mozzo	Ø25.95
Diametro Girante	Ø68
N° Alette Girante	12
Posizione Girante	17



FIAT

Croma I

2000 i.e.	85	10/87 → 08/96	B	154C3.046, 834B.146	03-1991 →, T →: 285.922
	88	03/87 → 09/92	B	154C3.000, 834B.000	03-1991 →, T →: 285.922
2000 i.e. Turbo	110	06/87 → 08/96	B	154C4.046, 834C.146	04-1991 →, T →: 285.922

Tempra, Station Wagon

2.0 i.e.	83	10/90 → 08/96	B	159A6.046	→ 12-1991
----------	----	---------------	---	-----------	-----------

Tipo I

2.0 i.e.	80	06/90 → 03/92	B	159A5.046	→ 06-1991
	83	03/90 → 04/95	B	159A6.046	→ 06-1991

LANCIA

Dedra, Station Wagon

1.8 i.e.	77	09/89 → 07/99	B	835A2.046	09-1989 →, → 04-1994
	80	09/89 → 06/94	B	835A2.000	
2.0 i.e.	83	09/89 → 07/99	B	835A5.046	09-1989 →, → 04-1994
	86	09/89 → 07/92	B	835A5.000	

Thema I, Station Wagon

2000 i.e.	86	09/88 → 05/92	B	834B1.000	
	85	09/87 → 05/92	B	834B.146	
2000 i.e. Turbo	110	07/86 → 05/90	B	834C.146	12-1985 →, → 05-1990
2000 Turbo	110	01/89 → 03/92	B	834C.146	

81463

350981463000



<b>FLANGIA</b>	
Numero Fori Flangia	3
Dimensione Fori Flangia	M8x1.25
Posizione Attacco	78.5
Diametro Mozzo	Ø22
Diametro Centraggio	Ø25.95
Diametro Girante	Ø70
N° Alette Girante	7
Posizione Girante	28



FIAT

Tipo I

1.7 D	43	01/88 → 10/94	D	149B4.000	(+)COP, → 12-1992
	45	01/88 → 10/95	D	149B4.000	(+)COP, → 12-1992
1.9 D	48	07/91 → 08/95	D	149A1.000, 160A7.000	(+)COP, → 12-1992

81464

350981464000



<b>PULEGGIA</b>	
Diametro Puleggia	Ø100
Numero Denti/Gole Puleggia	6
Posizione Attacco	80.6
Diametro Girante	Ø70
N° Alette Girante	7
Posizione Girante	28



ALFA ROMEO

145

1.9 TD	66	10/94 → 02/99	D	AR33601, AR67501	(+)COP, 10-1994 →, → 09-1996
--------	----	---------------	---	---------------------	------------------------------------

146

1.9 TD	66	12/94 → 02/99	D	AR33601, AR67501	(+)COP, 12-1994 →, → 09-1996
--------	----	---------------	---	---------------------	------------------------------------

155

1.9 TD	66	04/93 → 12/97	D	AR67501	(+)COP, 04-1993 →, → 02-1996
--------	----	---------------	---	---------	------------------------------------



**81464 350981464000**

**FIAT**
**Tempra, Station Wagon**

1.9 TD	66	05/90 → 08/96	D	160A6.000, 160D1.000	(+)COP, → M: 1.071.902, (+)AC
--------	----	---------------	---	-------------------------	-------------------------------------

**Tipo I**

1.9 TD	59	03/92 → 06/93	D	160B6.046	(+)COP, → 12-1992, (+)SS, (+)AC
	66	09/90 → 04/95	D	160A6.000, 160A6.046, 160D1.000	(+)COP, → 12-1992, (+)AC, (+)SS, (+)AC

**LANCIA**
**Dedra, Station Wagon**

1.9 TDS	66	04/89 → 07/99	D	160D1.000, 835A4.000, 835A4.046	(+)COP, → 04-1994
---------	----	---------------	---	---------------------------------------	----------------------

**81469 350981469000**

**FLANGIA**

Numero Fori Flangia	3
Dimensione Fori Flangia	M8×1.25
Posizione Attacco	61.5
Diametro Mozzo	Ø22
Diametro Centraggio	Ø25.95
Diametro Girante	Ø70
N° Alette Girante	7
Posizione Girante	28

**FIAT**
**Uno I**

1.7 D	43	11/94 → 08/00	D	146B2.000	(+)COP
1.9 D	44	09/89 → 03/94	D	149B5.046	(+)COP
	58	01/89 → 12/91	D		(+)COP
60 Diesel 1.7	42	09/89 → 12/93	D	146B2.000	(+)COP

**81476 350981476000**

**PULEGGIA**

Diametro Puleggia	Ø122.5
Numero Denti/Gole Puleggia	4
Posizione Attacco	76.7
Diametro Girante	Ø65
N° Alette Girante	7
Posizione Girante	50

**FIAT**
**Fiorino III, Pick Up (Uno)**

1.4	49	05/94 → 05/01	B	146D5.000	(+)COP, → M: 9.470.268
	52	11/92 → 10/96	B	146C5.000	(+)COP, → M: 9.470.268
1.6	55	01/94 → 05/01	B	146C6.000, 146D6.000	(+)COP, → M: 9.470.268
70 i.e. 1.4	49	05/94 → 05/01	B	146C5.000, 146D5.000	(+)COP, → M: 9.470.268
75 i.e. 1.6	55	10/93 → 05/01	B	146C6.000, 146D6.000	(+)COP, → M: 9.470.268

**Tempra, Station Wagon**

1.4 i.e.	51	03/92 → 08/96	B	160A1.046, 836A4.000	(+)COP, → M: 9.336.692, (+)AC
	57	03/91 → 08/96	B	159A2.000	(+)COP, → M: 9.336.692, (+)AC
1.6	51	04/90 → 06/93	B	159A3.048	(+)COP, (+)AC
	63	12/90 → 04/93	B	159A3.000	(+)COP, (+)AC
	63	03/90 → 04/93	B	159A3.000, 159B9.000	(+)COP, (+)AC
1.6 i.e.	57	06/90 → 07/92	B	159A3.046	(+)COP, (+)AC
	57	10/90 → 08/96	B	159A3.046, 835C1.000	(+)COP, → 12-1992, (+)AC

**Tipo I**

1.4 i.e.	57	05/89 → 04/95	B	159A2.000	(+)COP, (+)AC
	51	05/89 → 04/95	B	160A1.046, 836A4.000	(+)COP, (+)AC
1.6	61	01/88 → 10/91	B	160A2.000	(+)COP, (+)AC
1.6 i.e.	55	10/92 → 04/95	B	159A3.048, 835C1.000	(+)COP, (+)AC
	57	07/90 → 01/93	B	159A3.046	(+)COP, (+)AC

**Uno I**

70 i.e. 1.4	51	09/89 → 12/93	B	160A1.046	(+)COP, (+)AC
	53	09/89 → 12/93	B	146C1.000	(+)COP, (+)AC

**81476**
**350981476000**

**INNOCENTI**
**Elba**

1.4 i.e.	49	09/94 → 12/96	B	146C5.000, 146D5.000	(+)COP, → 02-1995
1.6 i.e.	55	09/94 → 12/96	B	146C6.000, 146D6.000	(+)COP

**LANCIA**
**Dedra, Station Wagon**

1.6 i.e.	57	08/89 → 03/93	B	835A1.046	(+)COP
	66	08/89 → 06/94	B	835A1.000	(+)COP

**81477**
**350981477000**

**FLANGIA**

Numero Fori Flangia	3
Dimensione Fori Flangia	M8×1.25
Posizione Attacco	83.5
Diametro Mozzo	Ø23
Diametro Centraggio	Ø25.95
Diametro Girante	Ø68
N° Alette Girante	12
Posizione Girante	17

**FIAT**
**Tempra, Station Wagon**

1.8 i.e.	81	03/90 → 08/96	B	159A4.000	→ 06-1992
----------	----	---------------	---	-----------	-----------

**Tipo I**

1.6 i.e.	66	02/88 → 05/91	B	149C2.046	
1.6 SX DGT	66	05/89 → 10/95	B	159A3.000	
1.8 i.e.16V Sport	100	11/89 → 06/92	B	160A5.000	

**81481**
**350981481000**

**PULEGGIA**

Diametro Puleggia	Ø115
Numero Denti/Gole Puleggia	1
Posizione Attacco	74
Diametro Girante	Ø65
N° Alette Girante	7
Posizione Girante	50

**FIAT**
**Uno I**

1.4 Turbo i.e.	82	09/89 → 09/93	B	146A8.046	(-)COP
	87	12/89 → 12/96	B	146A8.000	(-)COP
70 i.e. 1.4	51	09/89 → 12/93	B	160A1.046	(-)COP, (-)AC
	53	09/89 → 12/93	B	146C1.000	(-)COP, (-)AC

**INNOCENTI**
**Koral**

55	40	01/90 → 12/92	B	146A6.000	(-)COP
----	----	---------------	---	-----------	--------

**LANCIA**
**Delta I**

1.1	47	01/86 → 12/90	B	831B8.000	(-)COP
	58	09/83 → 08/92	B	831A2.000	(-)COP
1.3	55	09/79 → 08/92	B	831A2.000, 831B.000	(-)COP
	63	09/79 → 12/92	B	831A1.000, 831B1.000	(-)COP, → 03-1986

**Prisma**

1.3	58	01/83 → 02/92	B	831A2.000	(-)COP
-----	----	---------------	---	-----------	--------

**ZASTAVA**
**101**

1.3	48	10/81 → 12/93	B	128AR.000	(-)COP
-----	----	---------------	---	-----------	--------

**Yugo**

60 EFI	44	08/91 → 06/95	B	100GL.0.64, 11E1.064	(-)COP
	48	08/91 → 06/95	B	13E1.064	(-)COP

**Yugo Florida**

1.3	50	03/91 →	B	13E.3.064	(-)COP
1.4	52	10/88 → 06/95	B	160A1.000	(-)COP

**81488**
**350981488000**

**KW**

**FIAT**
**Ducato I**

2.4 D	53	01/82 → 08/90	D	8144.61	10-1986 →
2.5 D 4x4	55	03/89 → 08/90	D	8144.67	
2.5 TD	68	01/86 → 08/90	D	8144.21	
	68	01/87 → 08/90	D	8144.21, 8144.21.220	
2.5 TD 4x4	68	01/86 → 08/90	D	8144.21	
	70	09/86 → 05/90	D	8140.27	

**Ducato II**

2.5 D	55	07/90 → 03/94	D	8144.67	
2.5 D 4x4	55	07/90 → 03/94	D	8144.67	
2.5 TD	70	07/90 → 03/94	D	8140.27	
2.5 TD 4x4	70	07/90 → 03/94	D	8140.27	

**81489**
**350981489000**

**KW**

**FIAT**
**Ducato I**

1.9 D	52	01/88 → 08/90	D	149B1.000	
1.9 TD	60	03/89 → 08/90	D	280A1.000	

**Ducato II**

1.9 D	52	07/90 → 03/94	D	149B1.000	
1.9 TD	60	03/89 → 03/94	D	280A1.000	

**Talento**

1.9 D	52	03/89 → 03/94	D	149B1.000	
-------	----	---------------	---	-----------	--

**81490**
**350981490000**

**KW**

**FIAT**
**Croma I**

2000 16V	101	08/92 → 08/96	B	154E1.000	
----------	-----	---------------	---	-----------	--

**LANCIA**
**Delta I**

2.0 16V HF Evo Integrale	155	06/93 → 01/94	B	831E5.000, 831E5.046	
2.0 16V HF Integrale	144	03/89 → 09/91	B	831D5.000	
2.0 HF Integrale	130	12/86 → 12/92	B	831C5.046	

**Kappa, Station Wagon, Coupé**

2.0 16V Turbo	151	02/95 → 10/01	B	838A4.000	
------------------	-----	---------------	---	-----------	--

**Thema I, Station Wagon**

2000 16V	112	08/92 → 12/93	B	834F1.000	
2000 16V Turbo	133	12/88 → 06/90	B	834C1.000	
	148	10/92 → 07/94	B	834F2.000	
2000 i.e. 16V	104	02/89 → 05/92	B	834B2.246	
	108	05/88 → 08/92	B	834B2.000	
2000 i.e. 16V Turbo	130	04/89 → 05/92	B	834C1.246	
	133	12/88 → 06/90	B	834C1.000	
2000 Turbo 16V	148	11/92 → 07/94	B	834F2.000	

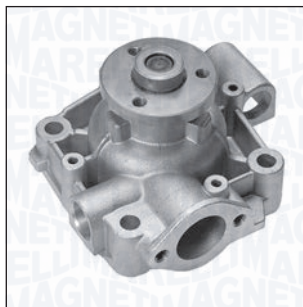
**81491**
**350981491000**

**FLANGIA**

Numero Fori Flangia	3
Dimensione Fori Flangia	M8x1.25
Posizione Attacco	82
Diametro Mozzo	Ø28
Diametro Girante	Ø93.5
N° Alette Girante	8
Posizione Girante	14.5

**KW**

**IVECO**
**Daily II**

35-10	68	01/89 → 12/96	D	8140.97.2781	→ 12-1990
	76	01/89 → 12/96	D	8140.47R.2790	→ 12-1990

**RENAULT**
**Master II**

2.5 D	59	07/98 → 01/01	D	S8U770	11-1989 →
-------	----	---------------	---	--------	-----------

**81497**
**350981497000**

**PULEGGIA**

Diametro Puleggia	Ø104
Numero Denti/Gole Puleggia	1
Posizione Attacco	65.8
Diametro Girante	Ø69
N° Alette Girante	7
Posizione Girante	45.6

**KW**

**SEAT**
**Ibiza I**

1.7 D	40	06/84 → 05/93	D	022A.5000	(+)COP, 01-1990 →
	42	08/90 → 05/93	D	022A.5000	(+)COP, 01-1990 →, → 12-1993

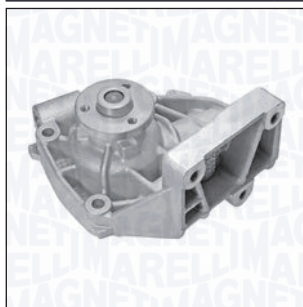
**81492**
**350981492000**

**FLANGIA**

Numero Fori Flangia	3
Dimensione Fori Flangia	M8x1.25
Posizione Attacco	82.8
Diametro Mozzo	Ø28
Diametro Girante	Ø93.5
N° Alette Girante	8
Posizione Girante	14.5

**KW**

**FIAT**
**Ducato I**

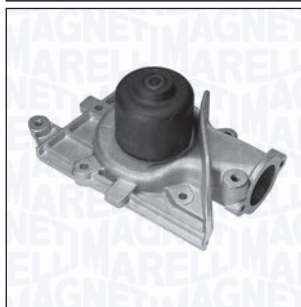
2.4 D	53	01/82 → 08/90	D	8144.61	→ 09-1986
-------	----	---------------	---	---------	-----------

**81498**
**350981498000**

**PULEGGIA**

Diametro Puleggia	Ø58
Posizione Attacco	78.5
Diametro Girante	Ø67.5
N° Alette Girante	8
Posizione Girante	9.5

**KW**

**SEAT**
**Ibiza I**

1.2	44	11/84 → 12/93	B	021A1000	
	46	11/84 → 12/93	B	021A1000	
1.2 i	52	01/89 → 05/93	B	021C.1000	
1.5	63	11/84 → 05/93	B	021A2000	
1.5 i	65	10/86 → 05/93	B	021D.2000	
	74	10/86 → 05/93	B	021B.2000	
1.5 i Cat.	66	10/86 → 05/93	B	021C.2000	
1.7	72	01/91 → 05/93	B	021A.3000	
	76	01/91 → 05/93	B	021B.3000	

**Malaga**

1.2	44	05/85 → 12/93	B	021A1000	
	47	11/84 → 12/93	B	021A1000	
1.2 i	52	12/89 → 12/93	B	021C.1000	
1.5	63	05/85 → 12/93	B	021A2000	
1.5 i	74	01/87 → 12/93	B	021B.2000	

**81498 350981498000**

**SEAT**
**Malaga**

1.5 i Cat.	66	10/86 → 12/93	B	021A2000, 021C.2000, 021D.2000
------------	----	---------------	---	--------------------------------------

**81499 350981499000**

**FLANGIA**

Numero Fori Flangia	4
Dimensione Fori Flangia	M6×1
Posizione Attacco	80
Diametro Mozzo	M30×1.5 SX
Diametro Centraggio	Ø35
Diametro Girante	Ø77
N° Alette Girante	4
Posizione Girante	15.4

**MERCEDES-BENZ**
**Classe C I (W202), Station Wagon (S202)**

C 180	89	11/94 → 05/00	B	M111.921
	90	03/93 → 05/00	B	M111.920, M111.921
C 180 T	90	06/96 → 09/00	B	M111.920, M111.921
	95	09/00 → 03/01	B	M111.952
C 200	100	01/94 → 05/00	B	M111.941, M111.945
C 200 CDI	75	03/98 → 05/00	D	OM611.960
C 200 Kompressor	132	10/95 → 05/00	B	M111.944
	141	11/96 → 05/00	B	M111.944
C 200 T	100	06/96 → 03/01	B	M111.941, M111.945
C 200 T Kompressor	120	09/00 → 03/01	B	M111.956
	141	11/96 → 03/01	B	M111.944
C 220	110	03/93 → 05/00	B	M111.961
C 220 T D	70	06/96 → 09/98	D	OM604.910
C 230	110	06/96 → 06/97	B	M111.974
C 230 T	110	06/96 → 06/98	B	M111.974

**Classe E I (W124), Station Wagon (S124), Cabrio (A124), Coupé (C124)**

E 200	100	06/93 → 03/98	B	M111.940	06-1993 →
	100	06/93 → 06/95	B	M111.940	
E 200 T	100	06/93 → 06/96	B	M111.940	06-1993 →, → 01-1996
E 220	110	06/93 → 03/98	B	M111.960	06-1993 →
	110	06/93 → 06/95	B	M111.960	
E 220 T	110	06/93 → 06/96	B	M111.960	

**81499 350981499000**

**MERCEDES-BENZ**
**Classe E II (W210), Station Wagon (S210)**

E 200	100	06/95 → 08/00	B	M111.942
E 200 Kompressor	120	08/00 → 03/02	B	M111.957
E 200 T	100	06/96 → 08/00	B	M111.942
E 200 T Kompressor	120	08/00 → 03/03	B	M111.957
E 230	110	06/95 → 06/97	B	M111.970
E 230 T	110	06/96 → 06/97	B	M111.970

**Classe M I (W163)**

ML 230	110	02/98 → 06/05	B	M111.977
--------	-----	---------------	---	----------

**Classe S V (W220), Coupé (C215)**

S 500	225	10/98 → 08/05	B	M113.960, M113.966
-------	-----	---------------	---	-----------------------

**CLK I (C208), Cabrio (A208)**

200	100	06/97 → 06/02	B	M111.945
-----	-----	---------------	---	----------

**Coupé III (C124)**

220 CE	110	10/92 → 05/93	B	M111.960
--------	-----	---------------	---	----------

**Kombi II (S124)**

220 TE	110	10/92 → 05/93	B	M111.960
--------	-----	---------------	---	----------

**Saloon (W124)**

200 E	100	10/92 → 06/93	B	M111.940
	110	10/92 → 06/93	B	M111.960

**SLK I (R170)**

200	100	09/96 → 03/00	B	M111.946
-----	-----	---------------	---	----------

**81504 350981504000**

**FLANGIA**

Numero Fori Flangia	4
Dimensione Fori Flangia	M6×1
Posizione Attacco	115
Diametro Mozzo	Ø27
Diametro Girante	Ø69
N° Alette Girante	8
Posizione Girante	21.5

**MERCEDES-BENZ**
**190 (W201)**

D 2.0	55	08/89 → 08/93	D	OM601.911
-------	----	---------------	---	-----------

**Classe C I (W202), Station Wagon (S202)**

C 200 D	65	10/96 → 05/00	D	OM604.915	06-1993 →
---------	----	---------------	---	-----------	-----------

**Classe E I (W124), Station Wagon (S124), Cabrio (A124), Coupé (C124)**

E 200 D	55	06/93 → 06/95	D	OM601.912
---------	----	---------------	---	-----------

**81504**
**350981504000**

**KW**

**MERCEDES-BENZ**
**Kombi II (S124)**

200 T D	53	09/85 → 08/91	D	OM601.912	01-1985 →, → 05-1993
	55	09/88 → 08/91	D	OM601.912	01-1985 →, → 05-1993

**Saloon (W124)**

200 D	55	08/89 → 06/93	D	OM601.912	
-------	----	---------------	---	-----------	--

**81506**
**350981506000**

**FLANGIA**

Numero Fori Flangia	4
Numero Fori Flangia (Serie 2)	2
Dimensione Fori Flangia	M6×1
Dimensione Fori Flangia (Serie 2)	Ø6
Posizione Attacco	106
Diametro Mozzo	Ø35
Diametro Girante	Ø69
N° Alette Girante	8
Posizione Girante	21.5

**KW**

**DAEWOO**
**Korando, Cabrio**

2.9 D	72	01/99 →	D	MB-OM662	
2.9 TD	88	01/99 →	D	MB-OM60129TD	

**Musso**

2.2 TD	74	09/99 →	D	MBOM601	
2.9 D 4x4	73	01/99 → 09/99	D	MB-OM662	
2.9 TD 4x4	88	01/99 →	D	MB-OM60129TD	

**MERCEDES-BENZ**
**190 (W201)**

D 2.5	66	04/85 → 08/93	D	OM602.911	
	69	08/89 → 08/93	D	OM602.911	
Turbo-D 2.5	90	02/88 → 08/93	D	OM602.961	01-1985 →, → 05-1993
	93	02/88 → 08/93	D	OM602.961	01-1985 →, → 05-1993

**Classe C I (W202), Station Wagon (S202)**

C 250 D	83	05/93 → 05/00	D	OM605.910	
---------	----	---------------	---	-----------	--

**Classe E I (W124), Station Wagon (S124), Cabrio (A124), Coupé (C124)**

E 250 D	83	07/93 → 06/95	D	OM605.911	→ M: 033.729
E 250 TD	83	06/93 → 06/96	D	OM605.911	01-1985 →
E 250 Turbo-D	93	06/93 → 06/95	D	OM602.962	01-1988 →
E 300 D	100	07/93 → 06/95	D	OM606.910	06-1993 →

**81506**
**350981506000**

**KW**

**MERCEDES-BENZ**
**Classe E I (W124), Station Wagon (S124), Cabrio (A124), Coupé (C124)**

E 300 T Turbo-D	108	06/93 → 06/96	D	OM603.960	01-1987 →
E 300 T Turbo-D 4-matic	108	06/93 → 06/96	D	OM603.963	01-1987 →
E 300 TD	100	06/93 → 06/96	D	OM606.910	07-1995 →
E 300 Turbo-D	108	06/93 → 06/95	D	OM603.960	06-1993 →
E 300 Turbo-D 4-matic	108	06/93 → 06/95	D	OM603.963	06-1993 →

**Classe E II (W210), Station Wagon (S210)**

E 250 D	83	06/95 → 07/99	D	OM605.912	01-1985 →
E 250 T D	83	06/96 → 07/99	D	OM605.912	01-1988 →
E 250 T Turbo-D	110	06/97 → 07/99	D	OM605.962	01-1988 →
E 250 Turbo-D	110	06/97 → 07/99	D	OM605.962	01-1988 →
E 290 T Turbo-D	95	06/96 → 07/99	D	OM602.982	
E 290 Turbo-D	95	03/96 → 07/99	D	OM602.982	
E 300 D	100	06/95 → 06/97	D	OM606.912	07-1995 →
E 300 T Turbo-D	130	12/96 → 07/99	D	OM606.962	07-1995 →
E 300 Turbo-D	130	12/96 → 07/99	D	OM606.962	

**Classe G (W460, W461), Cabrio (W463)**

250 GD	62	10/87 → 12/92	D	OM602.930	07-1982 →, → 10-1991
	68	12/88 → 08/92	D	OM602.930	07-1982 →, → 10-1991
	68	02/90 →	D	OM602.939	
	69	06/90 →	D	OM602.931	
290 GD/G 290 D	70	04/92 →	D	OM602.942	01-1992 →
300 GD	83	12/90 → 09/97	D	OM603.931	
350 G Turbo-D	100	09/91 → 09/97	D	OM603.972	→ M: 004.348
350 Turbo GD	100	09/91 →	D	OM603.972	
G 290 TD	88	07/97 →	D	OM602.983	
G 300 TD	130	08/96 →	D	OM606.964	

**81506 350981506000**

**MERCEDES-BENZ**
**Classe S IV (W140), Coupé (C140)**

S 300 Turbo-D	130	05/96 → 10/98	D	OM606.961	
S 350 Turbo-D	110	01/93 → 10/98	D	OM603.971	

**Classe V**

V 230 TD	72	09/96 → 07/03	D	OM601.970	
----------	----	---------------	---	-----------	--

**Kombi II (S124)**

250 T D	66	09/85 → 06/93	D	OM602.912	→ M: 033.729
	69	01/89 → 06/93	D	OM602.912	
300 T D	80	09/86 → 06/93	D	OM603.912	01-1985 →
	81	01/89 → 06/93	D	OM603.912	01-1985 →
300 T Turbo-D	83	01/89 → 06/93	D	OM603.912	01-1985 →
	108	01/89 → 06/93	D	OM603.960	01-1987 →
300 T Turbo-D 4-matic	108	01/89 → 06/93	D	OM603.960	01-1987 →

**Saloon (W124)**

250 D	66	04/85 → 06/93	D	OM602.912	
	69	01/89 → 06/93	D	OM602.912	
250 Turbo-D	93	09/88 → 06/93	D	OM602.962	01-1985 →
300 D	81	06/90 → 06/93	D	OM603.912	01-1985 →
	83	08/89 → 06/93	D	OM603.912	→ M: 054.122
300 D 4-matic	80	09/86 → 08/92	D	OM603.913	01-1985 →
	83	08/89 → 06/93	D	OM603.913	01-1985 →
300 Turbo-D	108	09/88 → 06/93	D	OM603.960	01-1987 →
300 Turbo-D 4-matic	108	01/88 → 06/93	D	OM603.963	01-1987 →

**Sprinter I (901, 902, 903, 904)**

208 D	58	02/95 → 04/00	D	OM601.943	
210 D	75	03/97 → 04/00	D	OM602.980	12-1994 →
212 D	90	02/95 → 04/00	D	OM602.980	12-1994 →
	90	02/95 → 04/00	D	OM602.980	
308 D	60	03/97 → 04/00	D	OM601.943	
308 D 2.3	60	02/95 → 04/00	D	OM601.943	→ 04-1995
310 D	75	01/97 → 12/99	D	OM602.980	
310 D 2.9	75	02/95 → 04/00	D	OM602.980	12-1994 →
310 D 4x4	75	05/97 → 08/02	D	OM602.980	12-1994 →
312 D 2.9	90	02/95 → 04/00	D	OM602.980	12-1994 →
	90	02/95 → 04/00	D	OM602.980	
312 D 2.9 4x4	90	05/97 → 08/02	D	OM602.980	12-1994 →
	90	05/97 → 08/02	D	OM602.980	

**81506 350981506000**

**MERCEDES-BENZ**
**Sprinter I (901, 902, 903, 904)**

410 D	75	02/96 → 05/06	D	OM602.980	12-1994 →
410 D 4x4	75	05/97 → 05/06	D	OM602.980	12-1994 →
412 D	85	02/96 → 05/06	D	OM602.980	12-1994 →
	90	02/96 → 05/06	D	OM602.980	12-1994 →
412 D 4x4	85	05/97 → 05/06	D	OM602.980	12-1994 →
	90	05/97 → 05/06	D	OM602.980	12-1994 →

**T1**

208 D 2.3	58	10/88 → 02/96	D	OM601.940	
	60	10/88 → 02/96	D	OM601.940	02-1988 →, → 04-1995
210 D 2.8	60	06/89 → 02/96	D	OM601.940	
	70	11/88 → 02/96	D	OM602.940	01-1983 →
210 D 2.9	72	11/88 → 02/96	D	OM602.940	01-1983 →
	72	11/88 → 02/96	D	OM602.940	
308 D 2.3	58	05/90 → 02/96	D	OM601.940	01-1983 →, → 04-1995
	60	06/89 → 02/96	D	OM601.940	01-1983 →, → 04-1995
310 D 2.9	70	06/89 → 02/96	D	OM602.940	01-1983 →
	70	06/89 → 02/96	D	OM602.940	
	72	06/89 → 02/96	D	OM602.940	
	72	06/90 → 02/96	D	OM602.940	01-1983 →

**Vario**

512 D	90	09/96 →	D	OM602.984	
612 D	90	09/96 →	D	OM602.984, OM602.985	
812 D	90	09/96 →	D	OM602.984, OM602.985	
O 812	90	09/96 →	D	OM602.984, OM602.985	

**Vito I (W638)**

108 D 2.3	58	02/96 → 07/03	D	OM601.942	
	58	03/97 → 07/03	D	OM601.942	11-1995 →
110 D 2.3	72	03/97 → 07/03	D	OM601.970	11-1995 →
110 TD 2.3	72	02/96 → 07/03	D	OM601.970	

**PUCH**
**G Model**

290 GD/G 290 D	70	04/92 →	D	OM602.942	
350 G Turbo D	100	09/91 →	D	OM603.972	
G 290 TD	88	07/97 →	D	OM602.983	

**81506**
**350981506000**

**SSANGYONG**
**Korando II, Cabrio**

2.3 D	58	12/96 →	D	OM601.940
2.9 D	72	11/97 →	D	MB-OM662
	72	12/96 →	D	MB-OM662
2.9 TD	88	04/98 →	D	

**Musso**

2.3 D	59	10/95 →	D	MB-OM661, OM601.940
2.9 D	73	03/96 →	D	MB-OM662
2.9 TD	88	04/98 →	D	

**Rexton**

2.9 TD	88	04/02 →	D	
--------	----	---------	---	--

**81507**
**350981507000**

**FLANGIA**

Numero Fori Flangia	3
Dimensione Fori Flangia	M8×1.25
Posizione Attacco	128.2
Diametro Mozzo	Ø30
Diametro Girante	Ø76
N° Alette Girante	4
Posizione Girante	22

**MERCEDES-BENZ**
**190 (W201)**

E 2.6	118	09/86 → 08/93	B	M103.942
-------	-----	---------------	---	----------

**Classe E I (W124), Station Wagon (S124), Cabrio (A124), Coupé (C124)**

E 300 4-matic	132	06/93 → 06/95	B	M103.985	01-1985 →, → 12-1996, M →: 094.339
E 300 T 4-matic	132	06/93 → 06/96	B	M103.985	06-1993 →, → 01-1996

**Classe G (W460, W461), Cabrio (W463)**

300 GE	125	06/90 →	B	M103.987	01-1989 →
	128	06/90 →	B	M103.987	01-1989 →

**Classe S III (W126), Coupé (C126)**

260 SE	118	09/85 → 06/91	B	M103.941	09-1985 →, → 06-1991, M →: 002.988
	122	09/85 → 06/91	B	M103.941	09-1985 →, → 06-1991, M →: 002.988
300 SE,SEL	132	01/86 → 06/91	B	M103.981	

**81507**
**350981507000**

**MERCEDES-BENZ**
**Coupé III (C124)**

300 CE	132	03/87 → 05/93	B	M103.983	M →: 018.293
--------	-----	---------------	---	----------	--------------

**Kombi II (S124)**

300 TE	132	01/86 → 08/92	B	M103.983	M →: 018.293
--------	-----	---------------	---	----------	--------------

300 TE 4-matic	132	09/86 → 06/93	B	M103.985	01-1985 →, → 05-1996, M →: 094.339
----------------	-----	---------------	---	----------	--

**Saloon (W124)**

260 E	118	09/85 → 08/92	B	M103.940	M →: 016.912
-------	-----	---------------	---	----------	--------------

260 E 4-matic	118	09/86 → 08/92	B	M103.943	01-1985 →, → 05-1996, M →: 035.732
---------------	-----	---------------	---	----------	--

300 E	138	01/85 → 08/92	B	M103.980, M103.983	01-1985 →, → 05-1996, M →: 018.293, → M: 018.293
	132	08/85 → 08/92	B	M103.983	M →: 018.293

300 E 4-matic	138	09/86 → 02/92	B	M103.983	01-1985 →, → 05-1993, M →: 094.339
	132	09/86 → 06/93	B	M103.985	02-1985 →, → 05-1993, M →: 094.339

**SL III (R129)**

300 SL	140	03/89 → 08/93	B	M103.984	06-1989 →, → 09-1993
--------	-----	---------------	---	----------	-------------------------

**PUCH**
**G Model**

300 GE	125	06/90 →	B	M103.987	
--------	-----	---------	---	----------	--



**81508**
**350981508000**

**ALBERINO**

Diametro Alberino	M12x1.5
Tipo Filetto Alberino	Femmina
Posizione Attacco	98
Diametro Girante	Ø68.5
N° Alette Girante	8
Posizione Girante	32.5

**KW**

**MERCEDES-BENZ**
**100**

D	41	12/90 → 12/94	D	OM616
	53	02/88 → 05/92	D	OM616.963
	55	12/90 → 02/96	D	OM616.963

**T1**

207 D 2.4	53	07/82 → 01/90	D	
	53	06/82 → 01/90	D	OM616.937, OM616.939
307 D 2.4	53	10/82 → 01/90	D	OM616.937, OM616.939

**81509**
**350981509000**

**FLANGIA**

Numero Fori Flangia	4
Dimensione Fori Flangia	M6x1
Posizione Attacco	98
Diametro Mozzo	Ø27
Diametro Girante	Ø80
N° Alette Girante	4
Posizione Girante	20.5

**KW**

**DAEWOO**
**Korando, Cabrio**

2.3	105	01/99 →	B	M161.970
-----	-----	---------	---	----------

**Musso**

2.3	103	01/99 →	B	M111.970
-----	-----	---------	---	----------

**MERCEDES-BENZ**
**190 (W201)**

2.0	75	01/86 → 05/90	B	M102.924
	77	09/84 → 05/90	B	M102.924
E 1.8	80	04/90 → 08/93	B	M102.910
E 2.0	87	01/85 → 08/93	B	M102.962
	93	10/82 → 06/93	B	M102.961
	90	10/82 → 06/93	B	M102.961, M102.962

**81509**
**350981509000**

**KW**

**MERCEDES-BENZ**
**190 (W201)**

E 2.3	97	09/86 → 08/91	B	M102.985	
	100	10/86 → 08/93	B	M102.985	
E 2.5-16	143	03/89 → 08/93	B	M102.991	
	150	09/88 → 08/93	B	M102.990	05-1991 →, → 05-1993
E Evolution II 2.5	173	05/90 → 08/93	B	M102.992	05-1991 →, → 05-1993

**Coupé III (C124)**

230 CE	97	03/87 → 12/92	B	M102.982
	100	03/87 → 12/92	B	M102.982

**Kombi II (S124)**

200 T	77	01/86 → 05/90	B	M102.922
200 TE	87	09/88 → 08/92	B	M102.963
230 TE	97	09/85 → 08/92	B	M102.982
	100	09/85 → 08/92	B	M102.982

**Saloon (W124)**

200	77	01/86 → 05/90	B	M102.922
	75	01/86 → 05/90	B	M102.922
	80	12/85 → 05/90	B	M102.922
200 E	87	09/88 → 08/92	B	M102.963
230 E	97	12/84 → 06/93	B	M102.982
	100	01/85 → 06/93	B	M102.982

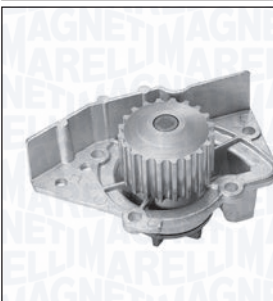
**81512**
**350981512000**

**PULEGGIA**

Diametro Puleggia	Ø59.26
Numero Denti/Gole Puleggia	20
Altezza Puleggia	33.5
Posizione Attacco	Ø2.5
Diametro Girante	Ø60
N° Alette Girante	6
Posizione Girante	40

**KW**

**CITROËN**
**Berlingo I, Van**

1.8 i	66	08/99 → 10/02	B	LFX (XU7JB)	
	66	05/97 →	B	LFX (XU7JB)	01-1998 →
1.8 i 4WD	66	04/97 →	B	LFX (XU7JB)	01-1998 →

**BX, Break**

1.9 GTi 4x4	92	02/92 → 06/94	B		PROD →: 5410
1.9 TZi	92	02/92 → 12/94	B	D6A (XU9J2)	PROD →: 5410
15	59	10/87 → 05/92	B	B1E (XU51C)	

**81512**
**350981512000**

**CITROËN**
**BX, Break**

16	53	01/87 → 02/93	B	B1E (XU51C)	02-1992 →, PROD →: 5410
	55	09/88 → 02/93	B	BAY (XU5CP), BAZ (XU5CP)	02-1992 →, PROD →: 5410
	58	09/87 → 02/93	B	B1A (XU51C/K)	02-1992 →, PROD →: 5410
	64	07/85 → 02/93	B	171D	02-1992 →, PROD →: 5410
	65	05/89 → 12/94	B	BDY (XU5M), BDZ (XU5M)	02-1992 →, PROD →: 5410
	68	10/82 → 12/92	B	XU52C	02-1992 →, PROD →: 5410
	76	03/86 → 02/93	B	180Z	02-1992 →, PROD →: 5410
	16 E	65	05/89 → 02/93	B	BDY (XU5M), BDZ (XU5M)
19	75	07/86 → 12/94	B	D2A (XU92C)	02-1992 →, PROD →: 5410
	80	06/88 → 12/94	B	DDZ (XU9M)	02-1992 →, PROD →: 5410
	88	06/88 → 12/94	B	DKZ (XU9JA)	02-1992 →, PROD →: 5410
19 Cat.	75	07/86 → 12/94	B	DFZ (XU9J1)	02-1992 →, PROD →: 5410
19 E	80	06/88 → 02/93	B	DDZ (XU9M)	02-1992 →, PROD →: 5410
19 E 4x4	80	04/89 → 02/93	B	D2F	02-1992 →, PROD →: 5410
19 GTi	88	06/88 → 02/93	B	DKZ (XU9JA)	02-1992 →, PROD →: 5410
	90	07/86 → 02/93	B	D6A (XU9J2)	02-1992 →, PROD →: 5410
19 GTi 16V	108	03/88 → 02/93	B	DFW (XU9J4)	02-1992 →, PROD →: 5410
19 GTi 4x4	88	06/88 → 02/93	B	DKZ (XU9JA)	02-1992 →, PROD →: 5410
<b>Evasion</b>					
1.8	73	05/97 → 07/02	B	LFZ (XU7JP)	06-1996 →

**81512**
**350981512000**

**CITROËN**
**Visa, Cabrio**

16 GTI	83	06/86 → 03/91	B	B6D	PROD →: 3584
17 D	44	04/84 → 03/91	D	161A (XUD7)	01-1987 →, PROD →: 3584

**Xantia I, Break**

1.6 i	65	03/93 → 01/98	B	BFZ (XU5JP)	11-1996 →
	66	04/97 → 01/98	B	LFX (XU7JB)	
1.8 i	74	03/93 → 01/98	B	LFZ (XU7JP)	03-1993 →, → 10-1996
	74	06/95 → 01/98	B	LFZ (XU7JP)	11-1996 →

**Xantia II, Break**

1.6 i SX	65	01/98 → 03/01	B	BFZ (XU5JP)	
1.8 i	66	01/98 → 04/03	B	LFX (XU7JB)	

**Xsara, Break, Coupé, Picasso, Van**

1.8 i	66	04/97 → 09/00	B	LFX (XU7JB)	
	66	10/97 → 09/00	B	LFX (XU7JB)	07-1997 →
	74	02/98 → 09/00	B	LFZ (XU7JP)	
1.8 i Aut.	74	04/97 → 09/00	B	LFZ (XU7JP)	07-1997 →
1.8 SX	76	06/00 → 08/05	B		

**ZX, Break**

1.6 i	65	03/91 → 06/97	B	BDY (XU5M), BFZ (XU5JP)	09-1992 →, PROD →: 5410
	65	10/93 → 10/97	B	BDY (XU5M), BFZ (XU5JP)	09-1992 →, PROD →: 5.410
1.8 i	74	07/92 → 06/97	B	LFZ (XU7JP)	PROD →: 5410
1.9 i	88	03/91 → 06/97	B	DKZ (XU9JA)	09-1992 →, PROD →: 5410

**FIAT**
**Ulysse I**

1.8	73	05/97 → 08/02	B	LFW	
-----	----	---------------	---	-----	--

**PEUGEOT**
**205 I, Van, Cabrio**

1.6 CJ	65	08/92 → 12/94	B	BDY (XU5M3Z)	
1.9 CTI	75	10/87 → 12/94	B	DFZ (XU9J1)	01-1992 →

**205 II, Van**

1.6 Aut.	58	10/87 → 09/98	B		01-1992 →
	65	05/90 → 09/98	B	BDY (XU5M2Z), BDY (XU5M3Z)	
1.9 GTI	88	10/87 → 10/94	B	DKZ (XU9JAZ)	01-1992 →
	94	10/87 → 09/98	B	D6B (XU9JA)	01-1992 →
1.9 GTI Cat.	75	10/87 → 07/94	B	DFZ (XU9J1)	01-1992 →

**81512 350981512000**

**PEUGEOT**
**306, Station Wagon, Coupé, Cabrio, Van**

1.8	74	05/93 → 05/01	B	LFZ (XU7JP)	
1.8 ST	74	06/94 → 05/01	B	LFZ (XU7JP)	

**309 II**

1.6	65	07/89 → 12/93	B	BDY (XU5M2Z), BDY (XU5M3Z), BDZ (XU5M)	02-1992 →
	68	07/89 → 12/93	B	B2A (XU52C/K)	02-1992 →
	69	07/89 → 12/93	B	B2A (XU52C/K)	02-1992 →
1.6 GTi	85	09/89 → 10/93	B		02-1992 →
1.9	72	08/89 → 12/93	B	DFZ (XU9J1)	02-1992 →
	80	10/90 → 12/93	B	DDZ (XU9M)	02-1992 →
1.9 GTI	88	07/89 → 12/93	B	DKZ (XU9JAZ)	02-1992 →
1.9 GTI 16V	108	10/90 → 12/93	B	DFW (XU9J4Z)	
	116	08/89 → 07/90	B	D6C (XU9J4)	

**405 I, Station Wagon**

1.9 4x4	108	07/90 → 07/92	B		
	116	06/87 → 07/92	B	D6C (XU9J4)	
1.9 Sport MI-16	108	04/88 → 12/92	B	DFW (XU9J4Z)	
	116	07/87 → 11/91	B	D6C (XU9J4)	
1.9 SPort MI-16 4x4	108	04/88 → 12/92	B	DFW (XU9J4Z)	

**405 II, Station Wagon**

1.6	65	08/92 → 10/95	B	BDY (XU5M2Z), BDY (XU5M3Z), BDZ (XU5M), BFZ (XU5JP)	
1.8	74	08/92 → 10/95	B	LFZ (XU7JP)	
1.9 D	47	08/92 → 10/95	D	DJZ (XUD9Y)	
	50	06/94 → 10/95	D	DJY (XUD9A)	
1.9 TD	66	08/92 → 10/95	D	DHY (XUD9TE)	

**407, Station Wagon, Coupé**

1.6	65	11/95 → 05/04	B	BFZ (XU5JP)	
1.8	66	05/97 → 05/04	B	LFX (XU7JB)	
	66	05/97 → 10/04	B	LFX (XU7JB)	06-1997 →

**81512 350981512000**

**PEUGEOT**
**806**

1.8	73	07/95 → 08/02	B	LFW (XU7JP)	
-----	----	---------------	---	-------------	--

**Expert I**

1.8	74	10/96 → 09/00	B	LFZ (XU7JP)	
-----	----	---------------	---	-------------	--

**Partner I**

1.8	66	05/97 →	B	LFX (XU7JB)	03-1997 →
1.8 D	43	06/96 →	D	A9A (XUD7)	03-1997 →

**81513 350981513000**

**CITROËN**
**AX**

1.4 Allure	48	08/92 → 04/94	B	K1F	
1.4 GTi	66	08/91 → 12/96	B	KFY (TU3FJ2)	08-1992 →
	69	06/91 → 12/96	B	KFZ (TU3FJ2)	08-1992 →
14	74	06/91 → 12/92	B	KFZ (TU3FJ2)	PROD → : 5.279
	55	04/87 → 04/97	B	KDX (TU3M/Z), KDY (TU3FM), KDY (TU3M), KDZ (TU3M/Z)	08-1992 →
14 4x4	55	08/91 → 12/96	B	KDX (TU3M/Z), KDY (TU3FM), KDY (TU3M), KDZ (TU3M/Z)	08-1992 →
	40	08/94 → 12/97	D	VJY (TUD5)	05-1994 →
15 D	43	08/94 → 12/97	D	VJY (TUD5), VJZ (TUD5)	

## 81513 350981513000



### CITROËN

#### BX, Break

14	53	01/86 → 02/93	B	150C	02-1992 →, PROD →: 5440
	55	01/89 → 02/93	B	KDY (TU3M)	02-1992 →, PROD →: 5440
	55	01/89 → 02/93	B	KDY (TU3M), KDZ (TU3M/Z)	02-1992 →, PROD →: 5440
14 E	49	09/85 → 02/93	B	150F	02-1992 →, PROD →: 5440
	53	04/83 → 02/93	B	150C	02-1992 →, PROD →: 5440

#### Saxo

1.5 D	40	09/96 → 09/03	D	VJY (TU5J)	
	42	09/96 → 06/01	D	VJZ (TU5J)	
1.6	66	02/96 → 06/03	B	NFZ (TU5JP)	
	74	02/01 → 04/04	B	NFT (TU5JP)	
1.6 VTL,VTR	65	05/96 → 06/03	B	NFZ (TU5JP)	
1.6 VTS	72	09/00 → 09/03	B	NFT (TU5JP)	

#### Xsara, Break, Coupé, Picasso, Van

1.5 D	42	04/97 → 09/00	D	VJZ (TU5J)	
	42	10/97 → 09/00	D	VJZ (TU5J)	→ PROD: 8385
1.6	65	12/99 →	B	NFZ (TU5JP)	
	67	06/02 →	B	NFZ (TU5JP)	
	70	12/99 →	B	NFV (TU5JP)	
1.6 16V	80	09/05 →	B	NFU (TU5JP4)	
1.6 Chrono	74	04/01 → 10/04	B		
1.6 i	65	04/97 → 09/00	B	NFZ (TU5JP)	07-1997 →
	65	02/98 → 09/00	B	NFZ (TU5JP)	

### MEGA

#### Club I

1.4 i	55	01/92 → 06/99	B		
1.4 i 4x4	55	01/92 → 06/99	B		
1.5 D	43	01/94 → 06/99	B		
1.5 D 4x4	43	01/94 → 06/99	B		

#### Club II

1.4 i	55	06/99 →	B		
-------	----	---------	---	--	--

### NISSAN

#### Micra II (K11)

1.5 D	42	02/98 → 02/03	D	TD15	
-------	----	---------------	---	------	--

## 81513 350981513000



### PEUGEOT

#### 106 I, Van

1.5 D	40	06/94 → 04/96	D	VJY (TU5J)	
	42	10/00 → 03/01	D	VJX (TU5J)	
	43	06/94 → 04/96	D	VJY (TU5J)	
1.6	76	01/94 → 04/96	B	NFY (TU5J2)	

#### 106 II

1.5 D	40	05/96 →	D	VJY (TU5J)	04-1996 →
	42	04/98 →	D	VJX (TU5J)	
1.6 i	74	05/96 →	B	NFW (TU5J2), NFY (TU5J2)	

#### 205 II, Van

1.6 i	65	09/98 → 12/00	B	NFZ (TU5JP)	
-------	----	---------------	---	-------------	--

#### 306, Station Wagon, Coupé, Cabrio, Van

1.6	65	05/93 → 10/00	B	NFZ (TU5JP)	
	72	10/00 → 05/01	B	NFT (TU5JP)	
1.6 SR	65	06/94 → 10/00	B	NFZ (TU5JP)	

#### 405 II, Station Wagon

1.4	55	08/92 → 10/95	B	KDX (TU3MC)	
-----	----	---------------	---	-------------	--

## 81520 350981520000



### VOLKSWAGEN

#### Golf II

1.0	37	08/85 → 10/91	B	HZ	→ M: 786.022
1.3 Cat.	40	06/86 → 12/92	B	2G, MH, NZ	→ M: 262.739

#### Jetta II

1.3 Cat.	40	06/87 → 12/91	B	2G, MH, NZ	
----------	----	---------------	---	------------	--

#### Polo II, Classic, Coupé, Van

1.0	33	01/85 → 09/94	B	AAK, AAU, HZ	→ 07-1992, → M: 015.867
	33	08/85 → 01/92	B	HZ	
1.0 Cat.	33	08/89 → 09/94	B	AAK, AAU, ACM	→ 07-1992, → M: 015.867
1.3	57	03/91 → 09/94	B	3F	→ M: 008.526

**81520 350981520000**

**VOLKSWAGEN**
**Polo II, Classic, Coupé, Van**

1.3 Cat.	40	07/87 → 09/94	B	2G, AAV, MH, NZ	→ M: 200.000
	40	07/87 → 09/94	B	MH, NZ	→ M: 200.000
	55	10/89 → 03/91	B	3F	→ M: 008.526
1.3 G40	83	08/90 → 09/94	B	PY	→ 08-1992, → M: 002.177
	85	01/87 → 08/90	B	PY	

**81521 350981521000**

**FLANGIA**

Numero Fori Flangia	3
Dimensione Fori Flangia	M8×1.25
Posizione Attacco	66
Diametro Mozzo	Ø40
Diametro Girante	Ø59
N° Alette Girante	6
Posizione Girante	29.5

**VOLKSWAGEN**
**Transporter III**

1.6 TD	51	08/84 → 07/92	D	JX	(-)COP, → M: 012.052
1.6 TD Syncro	51	03/86 → 07/92	D	JX	(-)COP, → M: 012.052

**81522 350981522000**

**FLANGIA**

Numero Fori Flangia	3
Dimensione Fori Flangia	M8×1.25
Posizione Attacco	74
Diametro Mozzo	Ø30
Diametro Girante	Ø59
N° Alette Girante	6
Posizione Girante	29.5

**AUDI**
**80 IV**

1.6	51	08/87 → 09/91	B	PP	(-)COP
	55	09/86 → 08/91	B	RN	(-)COP
	75	08/90 → 10/91	B	ABB	(-)COP
1.6 TD	59	09/86 → 08/91	D	RA, SB	(-)COP

**81522 350981522000**

**AUDI**
**80 IV**

1.8	55	10/86 → 01/90	B	RU	(-)COP
1.8 E	82	06/86 → 08/91	B	DZ	(-)COP
1.8 E quattro	82	09/86 → 08/91	B	DZ	(-)COP
1.8 quattro	83	09/86 → 08/90	B	SD	(-)COP
1.8 S	65	08/86 → 01/90	B	SF	(-)COP
	66	09/86 → 10/91	B	JN, NE, PM	(-)COP
1.8 S quattro	65	09/86 → 07/90	B	SF	(-)COP
	66	09/86 → 09/91	B	JN, NE, PM	(-)COP
1.9 D	50	08/89 → 08/91	D	1Y	(-)COP
2.0	82	10/90 → 08/91	B	AAD	(-)COP
2.0 E	83	08/88 → 10/90	B	3A	(-)COP
2.0 E 16V	101	03/90 → 09/91	B	6A	(-)COP
2.0 E 16V quattro	101	03/90 → 08/91	B	6A	(-)COP
2.0 E quattro	83	08/88 → 09/90	B	3A	(-)COP
2.0 quattro	82	08/88 → 07/90	B	3A	(-)COP
	85	10/90 → 08/91	B	AAD	(-)COP

**80 V, Avant**

1.6	52	09/91 → 12/94	B	ABM	(-)COP
1.6 E	74	06/93 → 12/94	B	ADA	(-)COP
1.9 TD	55	09/91 → 12/94	D	AAZ	(-)COP
1.9 TDI	66	09/91 → 12/94	D	1Z	(-)COP
2.0	66	09/91 → 12/94	B	ABT	(-)COP
2.0 E	85	09/91 → 12/94	B	ABK	(-)COP
2.0 E 16V	103	08/92 → 12/94	B	ACE	(-)COP
2.0 E 16V quattro	103	04/92 → 12/94	B	ACE	(-)COP
2.0 E quattro	85	09/91 → 12/94	B	ABK	(-)COP
2.0 quattro	79	11/93 → 01/96	B	ADW	(-)COP

**90 II**

1.6 TD	59	04/87 → 09/91	D	RA, SB	(-)COP
2.0 quattro	101	08/89 → 07/90	B	6A	(-)COP

**100 III, Avant**

1.8	65	02/86 → 07/90	B	SH	(-)COP
1.8 Cat.	66	03/85 → 11/90	B	4B, PH	(-)COP
1.8 quattro	65	08/86 → 07/90	B	SH	(-)COP
1.8 quattro Cat.	66	08/85 → 11/90	B	4B, PH	(-)COP

**100 IV, Avant**

2.0	74	12/90 → 06/94	B	AAE	(-)COP
2.0 E	74	09/91 → 06/94	B	AAE	(-)COP
	85	12/90 → 06/94	B	AAD, ABK	(-)COP
2.0 E 16V	103	01/92 → 06/94	B	ACE	(-)COP

**81522**
**350981522000**

**AUDI**
**100 IV, Avant**

2.0 E 16V quattro	103	07/92 → 06/94	B	ACE	(-)COP
2.0 E quattro	85	12/90 → 07/92	B	AAD	(-)COP

**A6 I, Avant**

1.9 TDI	66	06/94 → 10/97	D	1Z, AHU	(-)COP, M: 1Z
2.0	74	06/94 → 10/97	B	AAE	(-)COP
	79	08/95 → 07/96	B	ADW	(-)COP
	85	06/94 → 10/97	B	ABK	(-)COP
2.0 16V	103	06/94 → 10/97	B	ACE	(-)COP
2.0 16V quattro	103	06/94 → 10/97	B	ACE	(-)COP

**Cabriolet**

1.9 TDI	66	06/95 → 08/00	D	1Z, AHU	(-)COP
2.0 16V	103	06/95 → 07/96	B	ACE	(-)COP
2.0 E	85	01/93 → 07/98	B	ABK	(-)COP

**Coupé II**

2.0	82	03/90 → 07/90	B	3A	(-)COP
	83	05/89 → 03/90	B	3A	(-)COP
	85	05/89 → 12/96	B	AAD, ABK	(-)COP
2.0 16 V	101	01/92 → 07/92	B	6A	(-)COP
	103	08/92 → 12/96	B	ACE	(-)COP

**FORD**
**Galaxy I**

1.9 TDI	66	03/95 → 05/06	D	1Z, AHU, ANU	(-)COP, → 04-2000
	81	08/97 → 04/00	D	AFN, AVG	(-)COP, → 04-2000

**SEAT**
**Alhambra I**

1.9 TDI	66	04/96 → 03/10	D	1Z, AHU, ANU	(-)COP, → 07-2000
	81	08/96 → 06/00	D	AFN, AVG	(-)COP
2.0 i	85	04/96 → 03/10	B	ADY, ATM	(-)COP, → 07-2000, M: ADY

**Cordoba I, Vario**

1.6 i	55	05/94 → 06/99	B	1F	(-)COP
	74	09/96 → 06/99	B	AFT	(-)COP
	74	07/96 → 10/99	B	AFT, AKL	(-)COP
	55	09/96 → 06/99	B	AEE, ALM	(-)COP
1.8 i	66	02/93 → 06/99	B	ABS, ACC, ADZ	(-)COP, 10-1993 →
1.8 i 16V	95	10/93 → 08/96	B	ADL	(-)COP, 10-1993 →

**81522**
**350981522000**

**SEAT**
**Cordoba I, Vario**

1.9 D	47	01/96 → 08/96	D	1Y	(-)COP, 06-1996 →
	50	02/93 → 08/96	D	1Y	(-)COP, 10-1993 →
1.9 SDI	47	08/96 → 06/99	D	AEY	(-)COP, 05-1997 →
	47	09/96 → 06/99	D	AEY	(-)COP
1.9 TD	55	02/93 → 08/96	D	AAZ	(-)COP, 10-1993 →
	66	08/96 → 06/99	D	1Z, AHU	(-)COP
1.9 TDI		66	08/96 → 06/99	D	1Z, AHU
	81	03/97 → 06/99	D	AFN	(-)COP, 05-1997 →
81	07/97 → 06/99	D	AFN	(-)COP	
2.0 i	85	02/93 → 06/99	B	2E, AGG	(-)COP, 10-1993 →
2.0 i 16V	110	08/96 → 06/99	B	ABF	(-)COP, 02-1997 →

**Ibiza II**

1.6 i	55	09/94 → 06/99	B	1F	(-)COP
	74	04/96 → 08/99	B	AFT	(-)COP
	55	03/93 → 08/99	B	ABU, AEE, ALM	(-)COP, 01-1995 →, M: AEE
1.8 i	66	03/93 → 08/99	B	ABS, ACC, ADZ	(-)COP, 01-1993 →
1.8 i 16V	95	11/93 → 08/96	B	ADL	(-)COP
1.9 D	47	04/93 → 08/96	D	1Y, AEY	(-)COP
	50	10/94 → 08/96	D	1Y	(-)COP
1.9 SDI	47	08/96 → 08/99	D	AEY	(-)COP
1.9 TD	55	03/93 → 08/96	D	AAZ	(-)COP, 06-1994 →
2.0 i	85	03/93 → 08/99	B	2E, AGG	(-)COP
2.0 i 16V	110	08/96 → 08/99	B	ABF	(-)COP

**Inca**

1.6 i	55	11/95 → 05/98	B	1F	(-)COP, 11-1995 →
1.7 D	42	09/96 → 06/03	D	AHB	(-)COP
1.9 D	47	11/95 → 06/03	D	1Y	(-)COP, 11-1995 →
1.9 SDI	47	11/95 → 06/03	D	1Y, AEY, AYQ	(-)COP, 11-1995 →

**81522**
**350981522000**

**SEAT**
**Toledo I**

1.6 i	52	05/91 → 12/93	B	1F	(-)COP
	54	05/91 → 03/99	B	1F, ABN, EZ	(-)COP, 05-1991 →
	55	01/93 → 03/99	B	1F	(-)COP, 05-1991 →
	74	11/96 → 03/99	B	AFT	(-)COP
1.8 16V	92	05/91 → 03/99	B	PL	(-)COP, 05-1991 →
	98	05/91 → 03/99	B	KR	(-)COP, 05-1991 →
1.8 GT	102	05/91 → 11/92	B	KR	(-)COP
1.8 i	65	05/91 → 12/96	B	RP	(-)COP
	66	11/93 → 12/96	B	ABS, ACC, ADZ	(-)COP
1.9 D	47	12/95 → 03/99	D	1Y	(-)COP, 05-1991 →
	50	05/91 → 03/99	D	1Y	(-)COP, 05-1991 →
1.9 TD	55	05/91 → 03/99	D	AAZ	(-)COP, 05-1991 →
1.9 TDI	66	08/95 → 03/99	D	1Z, AHU	(-)COP, 05-1991 →
	81	11/96 → 03/99	D	AFN	(-)COP, 05-1991 →
2.0 i	85	05/91 → 03/99	B	2E, AGG	(-)COP
2.0 i 16V	110	11/93 → 03/99	B	ABF	(-)COP, 01-1997 →

**VOLKSWAGEN**
**Caddy I**

1.6	55	01/83 → 07/92	B	EW	(-)COP
1.6 D	40	08/82 → 07/92	D	JK, ME	(-)COP
1.8	70	08/85 → 07/92	B	JH	(-)COP

**Caddy II**

1.6	55	11/95 → 05/97	B	1F	(-)COP
1.7 SDI	42	07/96 → 09/00	D	AHB	(-)COP
1.9 D	47	11/95 → 01/04	D	1Y	(-)COP
1.9 SDI	47	11/95 → 01/04	D	AEY, AYQ	(-)COP, M: AEY
1.9 TDI	66	09/96 → 01/04	D	1Z, AHU, ALH	(-)COP
	66	10/96 → 01/04	D	AHU, ALE, ALH	(-)COP
75 1.6	55	11/95 → 05/97	B	1F	(-)COP

**81522**
**350981522000**

**VOLKSWAGEN**
**Corrado**

1.8 16V	100	04/89 → 07/92	B	KR	(-)COP
1.8 G60	118	09/88 → 09/93	B	PG	(-)COP
2.0 i	85	04/93 → 12/95	B	2E, ADY	(-)COP
2.0 i 16V	100	08/91 → 12/95	B	9A	(-)COP

**Golf I, Cabrio**

1.6	53	04/86 → 02/90	B	RE	(-)COP
	55	08/83 → 04/92	B	EW, HN	(-)COP
1.8	66	08/83 → 09/92	B	EX	(-)COP
	70	08/83 → 04/93	B	JH	(-)COP
	72	08/89 → 03/93	B	2H	(-)COP

**Golf II**

1.6	51	10/86 → 12/92	B	PN	(-)COP
	53	02/86 → 10/91	B	RF	(-)COP
	55	08/83 → 07/92	B	ABN, EZ, HM	(-)COP
1.6 D	37	08/83 → 10/91	D		(-)COP
	40	08/83 → 10/91	D	JP, ME	(-)COP
1.6 TD	51	08/83 → 10/91	D	JR, MF	(-)COP
	59	04/89 → 10/91	D	RA, SB	(-)COP
	44	08/89 → 10/91	D	1V	(-)COP
1.8	62	08/86 → 01/90	B	RH	(-)COP
	66	08/84 → 10/91	B	GU, GX, HV	(-)COP
1.8 GTI	82	08/83 → 10/91	B	DX, EV, GZ, PB	(-)COP
1.8 GTI 16V	95	02/86 → 10/91	B	PL	(-)COP
	102	02/86 → 06/90	B	KR	(-)COP
1.8 GTI Cat.	79	01/87 → 10/91	B	PF	(-)COP
1.8 GTI G60	118	04/90 → 07/91	B	PG	(-)COP
1.8 GTI G60 Syncro	118	08/88 → 12/91	B	1H, PG	(-)COP
1.8 i Cat.	66	08/87 → 10/91	B	GX, RP	(-)COP
1.8 i Syncro Cat.	66	08/87 → 10/91	B	RP	(-)COP
1.8 Syncro	66	02/86 → 07/91	B	GU, GX	(-)COP
	72	08/88 → 07/91	B	1P	(-)COP
2.0	57	08/85 → 07/92	B		(-)COP

**Golf III, Variant, Cabrio**

1.6	74	10/94 → 05/98	B	AEK, AFT, AKS	(-)COP, 05-1996 →
	74	07/95 → 08/97	B	AEK, AFT, AKS	(-)COP

**81522**
**350981522000**

**VOLKSWAGEN**
**Golf III, Variant, Cabrio**

1.8	55	11/91 → 08/97	B	AAM	(-)COP
	55	07/93 → 04/99	B	AAM, ANN	(-)COP
	66	11/91 → 08/97	B	ABS, ACC, ADZ	(-)COP
	66	07/93 → 05/98	B	ABS, ADZ	(-)COP
	66	07/93 → 04/99	B	ABS, ADZ, ANP	(-)COP
1.8 Syncro	66	10/94 → 04/99	B	ADZ	(-)COP
	66	01/93 → 08/97	B	ABS, ADZ	(-)COP
1.9 D	48	11/91 → 08/97	D	1Y	(-)COP, → 07-1995
1.9 SDI	47	07/95 → 08/97	D	AEY	(-)COP
1.9 TD	55	07/93 → 04/99	D	AAZ	(-)COP, → 07-1995
1.9 TD, GTD	55	11/91 → 08/97	D	AAZ	(-)COP, → 07-1995
1.9 TDI	66	09/93 → 08/97	D	1Z, AHU, ALE	(-)COP, → 07-1995
	66	08/95 → 05/98	D	1Z, AHU, ALE	(-)COP, M: 1Z
	81	04/96 → 08/97	D	AFN	(-)COP
1.9 TDI Syncro	66	07/95 → 04/99	D	1Z, AHU, ALE	(-)COP, → 07-1995
2.0	85	11/91 → 08/97	B	2E, ABA, ADY, AGG, AKR	(-)COP
	85	07/93 → 05/98	B	2E, ADY, AGG, AKR	(-)COP, 08-1991 →
2.0 GTI 16V	110	08/92 → 08/97	B	ABF	(-)COP, 08-1991 →
2.0 Syncro	85	08/95 → 04/99	B	AGG	(-)COP, 08-1991 →
	85	08/95 → 08/97	B	AGG	(-)COP, 08-1991 →

**Golf IV, Variant, Cabrio**

1.6	74	06/98 → 06/02	B	AFT, AKS	(-)COP, 05-1996 →
1.8	55	06/98 → 06/02	B	AAM, ANN	(-)COP, 11-1991 →
	66	06/98 → 06/02	B	ADZ, ANP	(-)COP, 11-1991 →
1.9 TDI	66	06/98 → 06/02	D	AHU, ALE	(-)COP
	81	06/98 → 06/02	D	AFN, AVG	(-)COP

**81522**
**350981522000**

**VOLKSWAGEN**
**Golf IV, Variant, Cabrio**

2.0	85	06/98 → 06/02	B	AGG, AKR, ATU, AWF, AWG	(-)COP, 08-1991 →
-----	----	---------------	---	-------------------------	-------------------

**Jetta II**

1.6	51	10/86 → 10/91	B	PN	(-)COP
	53	03/86 → 10/91	B	RF	(-)COP
	55	01/84 → 07/92	B	ABN, EZ, HM	(-)COP
1.6 D	40	01/84 → 10/91	D	JP, ME	(-)COP
1.6 TD	51	01/84 → 10/91	D	JR, MF	(-)COP
	59	04/89 → 10/91	D	RA, SB	(-)COP
	44	01/90 → 10/91	D	1V	(-)COP
1.8	62	08/86 → 01/90	B	RH	(-)COP
	66	08/84 → 10/91	B	GU, GX, HV	(-)COP
	82	01/84 → 10/91	B	EV, GZ, PB	(-)COP
1.8 16V	95	08/86 → 10/91	B	PL	(-)COP
1.8 Cat.	66	08/87 → 10/91	B	GX, RP	(-)COP
	79	01/87 → 10/91	B	PF	(-)COP
1.8 Syncro	72	08/88 → 07/91	B	1P	(-)COP

**Passat III, Variant**

1.6	53	02/88 → 09/91	B	1F, EZ	(-)COP
	74	10/94 → 08/96	B	AEK, AFT	(-)COP
1.6 TD	59	08/88 → 09/93	D	RA, SB	(-)COP
1.8	55	08/90 → 08/96	B	AAM	(-)COP
	66	02/88 → 08/96	B	ABS, ADZ, RP	(-)COP
	79	04/88 → 07/93	B	PF	(-)COP
	82	04/88 → 07/92	B	PB	(-)COP
	102	08/91 → 09/93	B	KR	(-)COP
1.8 G60 Syncro	118	08/88 → 08/96	B	PG	(-)COP
1.8 GL	102	08/91 → 09/93	B	KR	(-)COP
1.9 D	50	05/89 → 10/93	D	1Y	(-)COP
1.9 TD	55	03/91 → 08/96	D	AAZ	(-)COP
1.9 TDI	66	10/93 → 08/96	D	1Z, AHU	(-)COP
	81	03/96 → 08/96	D	AFN	(-)COP
2.0	79	03/95 → 08/96	B	AEP	(-)COP
	85	02/90 → 10/96	B	2E, ABA, ADY, AGG	(-)COP
	85	02/90 → 05/97	B	2E, ADY, AGG	(-)COP
2.0 16V	125	04/88 → 07/91	B		(-)COP
	100	08/88 → 09/93	B	9A	(-)COP
	110	01/94 → 08/96	B	ABF	(-)COP



**81522 350981522000**

**VOLKSWAGEN**
**Passat III, Variant**

2.0 Syncro	81	09/89 → 07/92	B		(-)COP
	85	10/90 → 08/96	B	2E, ADY, AGG	(-)COP

**Polo III (6N1), Classic, Variant, Van**

1.6	74	05/97 → 09/01	B	AEH, AFT, AKL, APF, AUR	(-)COP, M: AFT
1.7 SDI	42	08/97 → 09/01	D	AKW	(-)COP
1.8	66	05/97 → 09/01	B	ADZ	(-)COP
1.9 SDI	47	06/97 → 09/01	D	AEY	(-)COP
1.9 TDI	66	05/97 → 09/01	D	AGR, AHU, ALE, ALH	(-)COP, M: ALE
100 1.6	74	12/95 → 09/01	B	AEH, AFT, AKL, APF, AUR	(-)COP, M: AFT
110 1.9 TDI	81	06/98 → 01/02	D	AFN, ASV	(-)COP
57 1.7 SDI	42	07/97 → 09/01	D	AKW	(-)COP
64 1.9 D	47	01/96 → 10/96	D	1Y	(-)COP
64 1.9 SDI	47	12/95 → 08/99	D	1Y, AEY	(-)COP
75 1.6	55	11/95 → 09/97	B	1F	(-)COP
90 1.8	66	01/97 → 09/01	B	ABS, ADD, ADZ	(-)COP
90 1.9 TDI	66	09/96 → 09/01	D	AGR, AHU, ALE, ALH	(-)COP, M: ALE

**Scirocco II**

1.6	53	04/86 → 07/90	B	RE	(-)COP
1.8	66	08/83 → 07/92	B	EX	(-)COP
	70	11/85 → 07/92	B	JH	(-)COP
1.8 16V	95	03/86 → 07/92	B	PL	(-)COP

**Sharan I**

1.9 TDI	66	09/95 → 03/10	D	1Z, AHU, ANU	(-)COP, 09-1995 →, → 03-2000, M: AHU, M: 1Z
	81	09/96 → 04/00	D	AFN, AVG	(-)COP
2.0	85	09/95 → 03/10	B	ADY, ATM	(-)COP, 09-1995 →, → 02-2000, M: ADY

**Transporter III**

1.6 TD	51	08/84 → 07/92	D	JX	(-)COP, M →: 012.053
1.6 TD Syncro	51	03/86 → 07/92	D	JX	(-)COP, M →: 012.053
1.7 D	42	10/86 → 07/92	D	KY	(-)COP

**81522 350981522000**

**VOLKSWAGEN**
**Transporter IV**

1.8	49	12/90 → 07/92	B	PD	(-)COP
1.9 D	44	09/90 → 12/95	D	1X	(-)COP
	45	07/90 → 12/95	D	1X	(-)COP
1.9 TD	50	10/92 → 04/03	D	ABL	(-)COP
2.0	62	07/90 → 04/03	B	AAC	(-)COP, 09-1990 →
	62	09/90 → 04/03	B	AAC	(-)COP

**Vento**

1.6	74	10/94 → 09/98	B	AEK, AFT	(-)COP
1.8	55	11/91 → 09/98	B	AAM	(-)COP
	66	11/91 → 09/98	B	ABS, ADZ	(-)COP
1.9 D	48	11/91 → 09/98	D	1Y	(-)COP
1.9 SDI	47	04/97 → 09/98	D	AEY	(-)COP
1.9 TD	55	11/91 → 09/98	D	AAZ	(-)COP
1.9 TDI	66	09/93 → 09/98	D	1Z, AHU, ALE	(-)COP
	81	04/96 → 09/98	D	AFN	(-)COP
2.0	85	11/91 → 09/98	B	2E, ADY, AGG, AKR	(-)COP
2.0 GL	62	11/91 → 07/98	B	AAC	(-)COP
	79	05/96 → 12/97	B	AEP	(-)COP

**81524 350981524000**

	<b>PULEGGIA</b>	
	Diametro Puleggia	Ø75
	Numero Denti/Gole Puleggia	30
	Altezza Puleggia	21
	Posizione Attacco	53.4
	Diametro Girante	Ø60
	N° Alette Girante	8
	Posizione Girante	31.5

**SEAT**
**Cordoba I, Vario**

1.4 i	44	06/94 → 06/99	B	ABD, AEX, AKV, APQ	→ 05-1996
1.6 i	55	02/93 → 06/99	B	ABU, AEE, ALM	

**Ibiza II**

1.0	33	03/93 → 09/96	B	AAU	
1.3 i	40	03/93 → 08/99	B	2G, AAV	
1.4 i	44	09/93 → 08/99	B	ABD, AEX, AKV, APQ	→ 07-1996, M: ABD

**81524**
**350981524000**

**SEAT**
**Ibiza II**

1.6 i	55	03/93 → 08/99	B	ABU, AEE, ALM	→ 12-1994, M: ABU
-------	----	---------------	---	---------------	-------------------

**VOLKSWAGEN**
**Golf II**

1.0	37	08/85 → 10/91	B	HZ	M →: 786.023
1.3 Cat.	40	06/86 → 12/92	B	2G, MH, NZ	M →: 262.740

**Golf III, Variant, Cabrio**

1.3	40	08/91 → 07/92	B	2G	
1.4	40	07/93 → 04/99	B	ABD	→ 07-1995
	40	11/91 → 08/97	B	ABD, AEX	11-1991 →, → 07-1995, M: ABD
	44	10/91 → 08/97	B	ABD, AEX	→ 07-1995, M: ABD
	44	07/93 → 04/99	B	ABD, AEX, APQ	→ 07-1995
1.6	55	09/92 → 08/97	B	ABU, AEA, AEE	→ 07-1995, M: ABU

**Polo II, Classic, Coupé, Van**

1.0	33	01/85 → 09/94	B	AAK, AAU, HZ	08-1992 →, M →: 015.868
	33	08/92 → 07/94	B	AAU	
1.0 Cat.	33	08/89 → 09/94	B	AAK, AAU, ACM	08-1992 →, M →: 015.868
1.3	40	08/92 → 07/94	B	AAV	
	57	03/91 → 09/94	B	3F	M →: 008.527
1.3 Cat.	40	07/87 → 09/94	B	2G, AAV, MH, NZ	M →: 200.001
	40	07/87 → 09/94	B	MH, NZ	M →: 200.001
	55	10/89 → 03/91	B	3F	M →: 008.527
1.3 G40	83	08/90 → 09/94	B	PY	09-1992 →, M →: 002.178

**Polo III (6N1), Classic, Variant, Van**

1.0	33	10/94 → 12/99	B	AEV	
-----	----	---------------	---	-----	--

**Vento**

1.4	40	11/91 → 09/98	B	ABD, AEX	M: ABD
	44	11/91 → 09/98	B	ABD, AEX	M: ABD
1.6	55	09/92 → 09/98	B	ABU, AEA, AEE	M: ABU

**81525**
**350981525000**

**PULEGGIA**

Diametro Puleggia	Ø53.3
Numero Denti/Gole Puleggia	18
Altezza Puleggia	22
Posizione Attacco	53.5
Diametro Girante	Ø60
N° Alette Girante	8
Posizione Girante	31.5

**SEAT**
**Terra**

1.3 D	33	03/90 → 12/94	D	MN	
1.4 D	35	10/90 → 12/95	D	1W	

**VOLKSWAGEN**
**Polo II, Classic, Coupé, Van**

1.3 D	33	08/86 → 07/90	D	MN	
1.4 D	35	10/90 → 09/94	D	1W	

**81526**
**350981526000**

**FLANGIA**

Numero Fori Flangia	3
Dimensione Fori Flangia	M8×1.25
Posizione Attacco	74
Diametro Mozzo	Ø30
Diametro Girante	Ø64
N° Alette Girante	7
Posizione Girante	29.5

**AUDI**
**A4 I, Avant**

1.6	74	11/94 → 09/01	B	ADP, AHL, ANA, ARM	(-)COP, 03-1996 →, → 12-1997
	74	11/94 → 10/00	B	ADP, AHL, ANA, ARM	(-)COP, 01-1995 →, → 12-1997
1.8	85	04/95 → 11/00	B	AFY	(-)COP
	92	01/95 → 11/00	B	ADR, APT, ARG, AVV	(-)COP
	95	01/95 → 11/00	B	ADR	(-)COP
	85	07/95 → 11/00	B	AFY	(-)COP
1.8 quattro	92	01/95 → 11/00	B	ADR, APT, ARG	(-)COP

**81526**
**350981526000**

**KW**

**AUDI**
**A4 I, Avant**

1.8 T	110	01/95 → 11/00	B	AEB, ANB, APU, ARK, AWT	(-)COP
	132	12/97 → 11/00	B	AJL	(-)COP
1.8 T quattro	110	01/95 → 11/00	B	AEB, ANB, APU, ARK, AWT	(-)COP
	132	12/97 → 11/00	B	AJL	(-)COP

**A6 I, Avant**

1.8	92	12/95 → 10/97	B	ADR	(-)COP
1.8 quattro	92	12/95 → 10/97	B	ADR	(-)COP

**A6 II, Avant**

1.8	85	05/97 → 01/05	B	AFY	(-)COP
1.8 T	110	01/97 → 01/05	B	AEB, ANB, APU, ARK, AWL, AWT	(-)COP, NOT FOR: MAWT
	110	12/97 → 01/05	B	AEB, ANB, APU, ARK, AWT	(-)COP, NOT FOR: MAWT
	132	12/97 → 01/05	B	AJL	(-)COP
1.8 T quattro	110	02/97 → 01/05	B	AEB, ANB, APU, ARK, AWT	(-)COP, NOT FOR: MAWT
	132	12/97 → 01/05	B	AJL	(-)COP

**Cabriolet**

1.8	92	01/97 → 08/00	B	ADR	(-)COP
-----	----	---------------	---	-----	--------

**VOLKSWAGEN**
**Passat IV, Variant**

1.6	74	10/96 → 11/00	B	ADP, AHL, ANA, ARM	(-)COP, → 12-1997, M: ADP
1.8	85	01/97 → 11/00	B	AFY	(-)COP
	92	10/96 → 11/00	B	ADR, APT, ARG	(-)COP
1.8 Syncro/ 4motion	92	10/96 → 11/00	B	ADR, APT, ARG	(-)COP
1.8 T	110	10/96 → 11/00	B	AEB, ANB, APU	(-)COP, M: ANB, M: AEB, M: ANB
1.8 T Syncro	110	11/96 → 08/00	B	AEB	(-)COP

**Passat V, Variant**

1.8	92	03/03 → 03/05	B	APT	(-)COP
-----	----	---------------	---	-----	--------

**81527**
**350981527000**

**PULEGGIA**

Diametro Puleggia	Ø67.24
Numero Denti/Gole Puleggia	27
Altezza Puleggia	20.7
Posizione Attacco	51.7
Diametro Girante	Ø63.6
N° Alette Girante	8
Posizione Girante	40.5

**KW**

**SEAT**
**Arosa**

1.4	44	05/97 → 06/04	B	AEX, AKK, AKV, ANW, APQ, AUD	→ 11-1999
-----	----	---------------	---	------------------------------------	-----------

**Cordoba I, Vario**

1.4 i	44	06/94 → 06/99	B	ABD, AEX, AKV, APQ	06-1996 →
	44	09/96 → 06/99	B	AEX, AKV, APQ	05-1997 →

**Cordoba II, Vario**

1.6	55	06/99 → 12/02	B	ABU, ALM	
	55	06/99 → 10/02	B	ALM	

**Cordoba III, Vario**

1.6	74	04/03 → 11/09	B	BAH	
-----	----	---------------	---	-----	--

**Ibiza II**

1.4	40	12/97 → 04/99	B	ANX	
1.4 i	44	09/93 → 08/99	B	ABD, AEX, AKV, APQ	08-1996 →, M: AEX
1.4 i 16V	74	06/97 → 08/99	B	AFH	

**Ibiza III**

1.6	55	08/99 → 02/02	B	ALM	
-----	----	---------------	---	-----	--

**Ibiza IV**

1.6	74	02/03 → 11/09	B	BAH	
-----	----	---------------	---	-----	--

**Inca**

1.4 i	44	11/95 → 06/03	B	AEX, AKV, APQ, AUD	01-1998 →
1.6 i	55	06/97 → 09/00	B	AEE, ALM	

**SKODA**
**Felicia I, Station Wagon**

1.6	55	06/97 → 04/02	B	AEE	
1.6 GLX	55	08/95 → 03/98	B	AEE	
1.6 LX	55	08/95 → 03/98	B	AEE, EA111	

**Felicia II, Station Wagon**

1.6	55	01/98 → 06/01	B	AEE	
-----	----	---------------	---	-----	--

**Octavia I, Station Wagon**

1.6	55	09/96 → 09/04	B	AEE	
-----	----	---------------	---	-----	--

81527

350981527000



**VOLKSWAGEN**

**Caddy II**

1.4	44	11/95 → 01/04	B	AEX, AKV, APQ, AUD	
1.6	55	06/96 → 12/00	B	AEE	
60 1.4	44	11/95 → 01/04	B	AEX, APQ, AUD	
75 1.6	55	11/95 → 09/00	B	AEE	

**Fox I**

1.4	55	04/05 →	B	BKR	
1.6	74	10/03 →	B	BAH, BJA, BLH, BPA, CCRA, CFZA	
1.6 Total Flex	74	10/03 →		BJA, BPA, CCRA	

**Golf III, Variant, Cabrio**

1.4	40	07/93 → 04/99	B	ABD	08-1995 →
	40	11/91 → 08/97	B	ABD, AEX	08-1995 →, M: AEX
	44	10/91 → 08/97	B	ABD, AEX	08-1995 →, M: AEX
	44	07/93 → 04/99	B	ABD, AEX, APQ	08-1995 →
1.6	55	09/92 → 08/97	B	ABU, AEA, AEE	05-1996 →, M: AEE, M: AEA, M: AEE

**Polo III (6N1), Classic, Variant, Van**

1.4	44	05/97 → 09/01	B	AEX, AKK, AKV, ANW, APQ, AUD	M: AEX, M: ANX, M: AKV, M: AEX, M: APQ, M: ANX
	44	05/98 → 12/99	B	AEX, APQ	
1.6	55	05/97 → 09/01	B	AEE, ALM	
45 1.0	33	10/94 → 09/96	B	AEV	
54 1.4	40	01/98 → 08/99	B	ANX	
55 1.3	40	10/94 → 07/95	B	ADX	
55 1.4	40	08/95 → 10/99	B	AEX	
60 1.4	44	12/95 → 09/01	B	AEX, AKK, AKV, ANW, APQ, AUD	M: APQ, M: AKV, M: ANX, M: APQ, M: AEX, M: AKV
	44	07/95 → 10/99	B	AEX, AKV, APQ	
75 1.6	55	10/94 → 10/99	B	AEA, AEE, AHS	
	55	11/95 → 09/01	B	AEE, ALM	

81527

350981527000



**VOLKSWAGEN**

**Polo V (9N)**

1.6	74	08/02 → 05/05	B	BAH	
	74	09/02 →	B	BAH, BPA, CFZA	

**Vento**

1.4	40	11/91 → 09/98	B	ABD, AEX	M: AEX
	44	11/91 → 09/98	B	ABD, AEX	M: AEX
1.6	55	09/92 → 09/98	B	ABU, AEA, AEE	M: AEE, M: AEA

81528

350981528000



**FLANGIA**

Numero Fori Flangia	3
Dimensione Fori Flangia	M8x1.25
Posizione Attacco	74.4
Diametro Mozzo	Ø30
Diametro Girante	Ø62
N° Alette Girante	6
Posizione Girante	25.8



**AUDI**

**A4 I, Avant**

1.9 DUO	66	03/98 → 09/01		AHU	M: AHU, M: AHH
	55	12/95 → 11/00	D	AFF	
1.9 TDI	66	01/95 → 11/00	D	1Z, AHH, AHU	
	81	10/95 → 11/00	D	AFN, AVG	
1.9 TDI quattro	81	09/96 → 11/00	D	AFN, AVG	

**A6 I, Avant**

1.9 TDI	66	06/94 → 10/97	D	1Z, AHU	M: AHU
---------	----	---------------	---	---------	--------

**A6 II, Avant**

1.9 TDI	81	04/97 → 10/00	D	AFN, AVG	
---------	----	---------------	---	----------	--

**SEAT**

**Arosa**

1.7 SDI	44	08/97 → 06/04	D	AKU	
---------	----	---------------	---	-----	--

**Ibiza II**

1.9 TDI	66	08/96 → 08/99	D	1Z, AHU	
	81	02/97 → 08/99	D	AFN	

**81528 350981528000**

**SKODA**
**Felicia I, Station Wagon**

1.9 D	47	10/95 → 03/98	D	AEF	
-------	----	---------------	---	-----	--

**Felicia II, Station Wagon**

1.9 D	47	01/98 → 06/01	D	AEF	
-------	----	---------------	---	-----	--

**VOLKSWAGEN**
**Caddy II**

1.9 D	47	06/96 → 12/00	D	AEF	
-------	----	---------------	---	-----	--

**Golf III, Variant, Cabrio**

1.9 D	48	11/91 → 08/97	D	1Y	08-1995 →
-------	----	---------------	---	----	-----------

1.9 D	48	07/93 → 04/99	D	1Y	08-1995 →, → 04-1996
-------	----	---------------	---	----	-------------------------

1.9 SDI	47	07/95 → 04/99	D	AEY	
---------	----	---------------	---	-----	--

1.9 TD	55	07/93 → 04/99	D	AAZ	08-1995 →, → 12-1997
--------	----	---------------	---	-----	-------------------------

1.9 TD,GTD	55	11/91 → 08/97	D	AAZ	08-1995 →
------------	----	---------------	---	-----	-----------

1.9 TDI	66	09/93 → 08/97	D	1Z,AHU,ALE	08-1995 →
---------	----	---------------	---	------------	-----------

1.9 TDI	66	03/94 → 04/99	D	1Z,AHU,ALE	07-1995 →, → 12-1997, M: AHU
---------	----	---------------	---	------------	------------------------------------

1.9 TDI Syncro	66	08/95 → 05/98	D	1Z,AHU,ALE	M: AHU
-------------------	----	---------------	---	------------	--------

1.9 TDI Syncro	66	07/95 → 04/99	D	1Z,AHU,ALE	08-1995 →
-------------------	----	---------------	---	------------	-----------

1.9 TDI Syncro	66	08/95 → 08/97	D	1Z,AHU,ALE	
-------------------	----	---------------	---	------------	--

**Lupo I**

1.7 SDI	44	09/98 → 07/05	D	AKU	11-1998 →
---------	----	---------------	---	-----	-----------

**Passat IV, Variant**

1.9 TDI	66	10/96 → 11/00	D	AHH, AHU	
---------	----	---------------	---	----------	--

1.9 TDI	81	10/96 → 11/00	D	AFN, AVG	
---------	----	---------------	---	----------	--

1.9 TDI Syncro/ 4motion	81	10/96 → 11/00	D	AFN, AVG	
-------------------------------	----	---------------	---	----------	--

**Polo III (6N1), Classic, Variant, Van**

1.7 SDI	42	04/97 → 10/99	D	AHG	
---------	----	---------------	---	-----	--

1.7 SDI	44	08/97 → 12/99	D	AKU	
---------	----	---------------	---	-----	--

1.9 D	47	10/94 → 12/99	D	AEF	
-------	----	---------------	---	-----	--

1.9 SDI	47	07/96 → 12/99	D	AGD	
---------	----	---------------	---	-----	--

1.9 TDI	66	05/97 → 09/01	D	AGR, AHU, ALE, ALH	M: AHU
---------	----	---------------	---	-----------------------	--------

1.9 TDI	81	06/98 → 09/01	D	AFN, ASV	M: AFN
---------	----	---------------	---	----------	--------

60 1.7 SDI	44	08/97 → 10/99	D	AKU	
------------	----	---------------	---	-----	--

64 1.9 D	47	10/94 → 10/99	D	AEF	
----------	----	---------------	---	-----	--

64 1.9 SDI	47	07/96 → 10/99	D	AGD	
------------	----	---------------	---	-----	--

90 1.9 TDI	66	09/96 → 09/01	D	AGR, AHU, ALE, ALH	M: AHU
------------	----	---------------	---	-----------------------	--------

**81528 350981528000**

**VOLKSWAGEN**
**Polo IV (6N2)**

1.7 SDI	44	10/99 → 09/01	D	AKU	
---------	----	---------------	---	-----	--

1.9 D	47	10/99 → 09/01	D	AEF	
-------	----	---------------	---	-----	--

1.9 SDI	47	10/99 → 09/01	D	AGD, ASX	
---------	----	---------------	---	----------	--

**81529 350981529000**

**FLANGIA**

Numero Fori Flangia	3
Dimensione Fori Flangia	M8×1.25
Posizione Attacco	74
Diametro Mozzo	Ø30
Diametro Girante	Ø64
N° Alette Girante	7
Posizione Girante	29.5

**AUDI**
**A4 I, Avant**

1.6	74	11/94 → 09/01	B	ADP, AHL, ANA, ARM	(+)COP, 03-1996 →, → 12-1997
-----	----	---------------	---	-----------------------	------------------------------------

1.6	74	11/94 → 10/00	B	ADP, AHL, ANA, ARM	(+)COP, 01-1995 →, → 12-1997
-----	----	---------------	---	-----------------------	------------------------------------

1.8	85	04/95 → 11/00	B	AFY	(+)COP
-----	----	---------------	---	-----	--------

1.8	92	01/95 → 11/00	B	ADR, APT, ARG, AVV	(+)COP
-----	----	---------------	---	-----------------------	--------

1.8	95	01/95 → 11/00	B	ADR	(+)COP
-----	----	---------------	---	-----	--------

1.8 quattro	85	07/95 → 11/00	B	AFY	(+)COP
-------------	----	---------------	---	-----	--------

1.8 quattro	92	01/95 → 11/00	B	ADR, APT, ARG	(+)COP
-------------	----	---------------	---	------------------	--------

1.8 T	110	01/95 → 11/00	B	AEB, ANB, APU, ARK, AWT	(+)COP
-------	-----	---------------	---	-------------------------------	--------

1.8 T	132	12/97 → 11/00	B	AJL	(+)COP
-------	-----	---------------	---	-----	--------

1.8 T quattro	110	01/95 → 11/00	B	AEB, ANB, APU, ARK, AWT	(+)COP
---------------	-----	---------------	---	-------------------------------	--------

1.8 T quattro	132	12/97 → 11/00	B	AJL	(+)COP
---------------	-----	---------------	---	-----	--------

**A6 I, Avant**

1.8	92	12/95 → 10/97	B	ADR	(+)COP
-----	----	---------------	---	-----	--------

1.8 quattro	92	12/95 → 10/97	B	ADR	(+)COP
-------------	----	---------------	---	-----	--------

**81529**
**350981529000**

**AUDI**
**A6 I, Avant**

2.6	102	06/94 → 02/97	B	ACZ	(+)COP, 08-1996 →, → 02-1997, T →: F44-S-026.715
-----	-----	---------------	---	-----	--

**A6 II, Avant**

1.8	85	05/97 → 01/05	B	AFY	(+)COP
-----	----	---------------	---	-----	--------

1.8 T	110	01/97 → 01/05	B	AEB, ANB, APU, ARK, AWL, AWT	(+)COP, NOT FOR: M AWT
	110	12/97 → 01/05	B	AEB, ANB, APU, ARK, AWT	(+)COP, NOT FOR: M AWT

1.8 T quattro	132	12/97 → 01/05	B	AJL	(+)COP
	110	02/97 → 01/05	B	AEB, ANB, APU, ARK, AWT	(+)COP, NOT FOR: M AWT

1.8 T quattro	132	12/97 → 01/05	B	AJL	(+)COP
	110	02/97 → 01/05	B	AEB, ANB, APU, ARK, AWT	(+)COP, NOT FOR: M AWT

**Cabriolet**

1.8	92	01/97 → 08/00	B	ADR	(+)COP
-----	----	---------------	---	-----	--------

**VOLKSWAGEN**
**Passat IV, Variant**

1.6	74	10/96 → 11/00	B	ADP, AHL, ANA, ARM	(+)COP, → 12-1997, M: ADP
-----	----	---------------	---	-----------------------	---------------------------------

1.8	85	01/97 → 11/00	B	AFY	(+)COP
	92	10/96 → 11/00	B	ADR, APT, ARG	(+)COP

1.8 Syncro/ 4motion	92	10/96 → 11/00	B	ADR, APT, ARG	(+)COP
------------------------	----	---------------	---	------------------	--------

1.8 T	110	10/96 → 11/00	B	AEB, ANB, APU	(+)COP, M: ANB, M: AEB, M: ANB
-------	-----	---------------	---	------------------	-----------------------------------

1.8 T Syncro	110	11/96 → 08/00	B	AEB	(+)COP
--------------	-----	---------------	---	-----	--------

**Passat V, Variant**

1.8	92	03/03 → 03/05	B	APT	(+)COP
-----	----	---------------	---	-----	--------

**81531**
**350981531000**

**FLANGIA**

Numero Fori Flangia	3
Dimensione Fori Flangia	M6×1
Posizione Attacco	70
Diametro Mozzo	Ø23.5
Diametro Girante	Ø57
N° Alette Girante	6
Posizione Girante	11.7

**FORD**
**Escort IV, Station Wagon, Cabrio, Express**

1.1	37	12/85 → 07/90	B	GSG	→ 12-1988
	37	05/86 → 07/90	B	GSG	

**Orion II**

1.3	44	12/85 → 07/90	B	JBB, JLA, JLB	
-----	----	---------------	---	------------------	--

**81532**
**350981532000**

**FLANGIA**

Numero Fori Flangia	4
Dimensione Fori Flangia	M8×1.25
Posizione Attacco	95.5
Diametro Mozzo	Ø23.5
Diametro Girante	Ø71
N° Alette Girante	7
Posizione Girante	12.5

**FORD**
**Sierra II, Station Wagon**

1.6	53	01/88 → 02/93	B	LSF	(-)SS
	53	01/88 → 02/93	B	LSF	
	55	01/87 → 02/93	B	LSE	

1.6 i	59	10/89 → 02/93	B	L6B	
	59	10/89 → 02/93	B	L6B	

2.0	77	01/87 → 02/93	B	N8C, NES	
	80	07/89 → 12/92	B	N8A	

2.0 4x4	88	01/90 → 02/93	B	N9C	
---------	----	---------------	---	-----	--

2.0 i	74	01/87 → 02/93	B	NE5, NEJ	
	80	06/89 → 02/93	B	N8A	

2.0 i Cat.	74	01/87 → 02/93	B	N4B	
------------	----	---------------	---	-----	--

**Transit IV**

1.6	46	09/85 → 09/92	B	LAT	
-----	----	---------------	---	-----	--

2.0	57	12/85 → 09/92	B	N6T	
	57	11/85 → 09/92	B	NAT, NAV	

**81536**
**350981536000**

**FLANGIA**

Numero Fori Flangia	3
Dimensione Fori Flangia	M6×1
Posizione Attacco	66
Diametro Mozzo	Ø25.5
Diametro Girante	Ø52.5
N° Alette Girante	9
Posizione Girante	13

**KW**

**FORD**
**Escort IV, Station Wagon, Cabrio, Express**

1.6 D	40	02/86 → 07/90	D	LTA
-------	----	---------------	---	-----

**81538**
**350981538000**

**PULEGGIA**

Diametro Puleggia	Ø59.2
Numero Denti/Gole Puleggia	20
Altezza Puleggia	28
Posizione Attacco	51.5
Diametro Girante	Ø71
N° Alette Girante	8
Posizione Girante	12

**KW**

**FORD**
**Escort IV, Station Wagon, Cabrio, Express**

1.4	51	10/85 → 10/90	B	FUAA	
	54	01/86 → 07/90	B	F6B, F6D, FUC	
	55	01/86 → 07/90	B	FUA	01-1986 →
	55	01/86 → 07/90	B	FUA	
1.4 i	54	02/86 → 07/90	B	F6B, F6D, FUC	
1.6	58	01/86 → 07/90	B	LP2	
	60	02/86 → 07/90	B	LUC	
	65	04/89 → 07/90	B	LUG	02-1982 →, → 12-1992
1.6 i	66	01/86 → 07/90	B	L4B	
	75	08/89 → 07/90	B	LJB	02-1982 →, → 12-1992
	75	08/89 → 07/90	B	LJB	
	66	01/86 → 05/90	B	L4B	
1.6 Turbo RS	97	01/86 → 07/90	B	LNB	02-1982 →, → 12-1992
1.6 XR3i	77	01/86 → 07/90	B	LR2, LRB	

**81538**
**350981538000**

**KW**

**FORD**
**Escort V, Station Wagon, Cabrio, Express**

1.4	52	07/90 → 12/94	B	F6F, F6G	
	52	07/90 → 09/92	B	F6F, F6G	
1.6	66	07/90 → 08/92	B	LUJ, LUK	
	77	07/90 → 12/92	B	LJF	

**Escort VI, Station Wagon, Cabrio**

1.4	52	09/92 → 01/95	B	F6F, F6G	
	52	12/92 → 04/94	B	F6F, F6G	
	55	01/94 → 01/95	B	F4B, FUH	
1.4 i	55	07/93 → 01/95	B	F4B	

**Escort VII, Station Wagon, Cabrio, Express**

1.4	54	01/95 →	B	F4B	
	55	01/95 → 10/98	B	F4B	
	55	02/95 → 08/98	B	F4B	01-1986 →
	55	01/95 → 02/99	B	F4B, FUH	

**Fiesta III, Van**

1.4	52	03/89 → 12/95	B	F6E	
	54	03/89 → 12/95	B	FUG, FUJ	
1.4 Cat.	54	03/89 → 12/95	B	F4A	
1.6	65	01/89 → 01/94	B	LUH	
1.6 Turbo	96	03/90 → 10/92	B	LHA	
1.6 XR2i	81	03/89 → 01/94	B	LJC	
	76	03/89 → 03/93	B	LJD	

**Orion II**

1.4	52	03/86 → 07/90	B	FUAA	
	54	01/86 → 07/90	B	FUC	
	55	12/85 → 07/90	B	FUA	
1.4 Cat.	54	02/87 → 07/90	B	F6B, F6D	
1.6	66	12/85 → 07/90	B	LUC	
1.6 i	75	08/89 → 07/90	B	LJB	
	77	03/86 → 07/90	B	LRB	
1.6 i Cat.	66	03/86 → 07/90	B	L4B	

**Orion III**

1.4	52	07/90 → 12/93	B	F6F, F6G	
	54	07/90 → 12/93	B	FUH	
1.6	66	07/90 → 12/92	B	LUJ, LUK	
1.6 i	77	07/90 → 09/92	B	LJF	

81543

350981543000

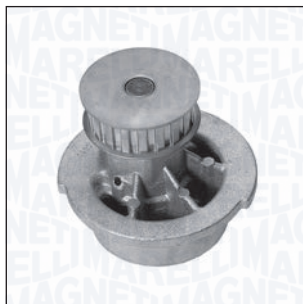

**PULEGGIA**

Diametro Puleggia Ø62.2  
 Numero Denti/Gole Puleggia 19  
 Posizione Attacco 59.5  
 Diametro Girante Ø55  
 N° Alette Girante 9  
 Posizione Girante 35



KW



**OPEL**

**Corsa A, Van**

1.3 GL	55	09/82 → 03/93	B	13S
1.3 i	44	09/86 → 09/90	B	C13N

**Kadett E, Station Wagon, Coupé, Cabrio, Van**

1.3 i Cat.	44	09/85 → 08/91	B	C13N
1.3 N	44	09/84 → 08/91	B	13N
	44	09/84 → 08/91	B	13N, 13NB
1.3 S	55	03/87 → 02/93	B	13S

**VAUXHALL**

**ASTRA**

1.3	55	09/85 → 08/91	B	13S
-----	----	---------------	---	-----

81549

350981549000

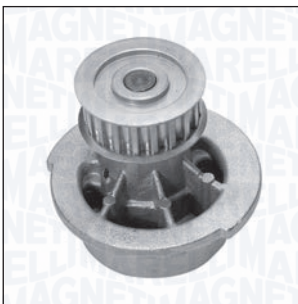

**PULEGGIA**

Diametro Puleggia Ø56.3  
 Numero Denti/Gole Puleggia 19  
 Altezza Puleggia 20  
 Posizione Attacco 59  
 Diametro Girante Ø55  
 N° Alette Girante 9  
 Posizione Girante 35

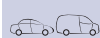

KW



**DAEWOO**

**Cielo**

1.5	66	06/94 → 07/98	B	V15L
-----	----	---------------	---	------

**Nexia I**

1.5	44	08/96 → 08/97	B	G15MF
	52	02/95 → 08/97	B	G15MF
	55	02/95 → 08/97	B	G15MF

**OPEL**

**Astra F Classic**

1.4 i	44	01/98 → 08/02	B	X14NZ
1.6 i	55	01/98 → 08/02	B	X16SZR

**Astra F, Station Wagon, Cabrio, Van**

1.4	55	09/91 → 09/93	B	14NV
	60	09/92 → 09/98	B	14SE
1.4 i	44	03/92 → 01/98	B	C14NZ
	44	09/91 → 09/98	B	C14NZ, X14NZ
1.4 Si	60	03/92 → 09/98	B	C14SE
1.6 i	52	05/93 → 07/96	B	X16SZ
	55	10/91 → 04/93	B	C16NZ
	55	03/92 → 09/98	B	C16NZ, X16SZR
1.6 Si	55	01/96 → 03/01	B	X16SZR
	74	05/92 → 12/94	B	C16SE

**Astra G, Station Wagon, Coupé, Cabrio, Van**

1.6	55	02/98 → 09/00	B	X16SZR
	55	09/98 → 09/00	B	X16SZR 09-1996 →
	62	09/00 → 01/05	B	Z16SE →M: 02MZ5253, →M: 20U75998
	62	09/00 → 04/05	B	Z16SE →M: 20U75998, →M: 02MZ5253

**Combo A**

1.2	33	07/94 → 10/01	B	C12NZ, X12SZ
1.4	44	07/94 → 10/01	B	C14NZ, X14SZ 09-1995 →, → 08-1996
	60	07/94 → 10/01	B	C14SE

81544

350981544000



**FLANGIA**

Numero Fori Flangia 3  
 Dimensione Fori Flangia M6×1  
 Posizione Attacco 86.5  
 Diametro Mozzo Ø22  
 Diametro Girante Ø60.9  
 N° Alette Girante 8  
 Posizione Girante -0.5



KW



**OPEL**

**Corsa A, Van**

1.0	33	09/82 → 03/93	B	10S
1.2	33	09/82 → 08/90	B	12NC, E12GV



**81549 350981549000**

**OPEL**
**Corsa A, Van**

1.2	44	09/82 → 08/90	B	12S	
1.2 i	33	09/89 → 03/93	B	C12NZ	
1.2 N	38	01/90 → 03/93	B	12NV	
1.2 S	40	09/82 → 02/90	B	12ST	
1.4 i	44	01/90 → 03/93	B	C14NZ	M →: 19.311.738
1.4 S	53	01/90 → 03/93	B	14NV	M →: 19.307.807
1.4 Si	60	09/91 → 03/93	B	C14SE	
1.6 GSI	55	08/88 → 09/92	B	C16NZ	T →: 02J22350
	72	09/89 → 03/93	B	C16SEI	M →: 19.311.739
	74	05/88 → 03/92	B	E16SE	T →: 02J22350
1.6 GSI Cat.	74	02/92 → 03/93	B	C16SE	

**Corsa B, Station Wagon, Van**

1.2 i	33	03/93 → 09/00	B	12NZ, C12NZ, X12SZ	
1.4	54	04/93 → 08/94	B	C14SE	
1.4 i	40	03/93 → 09/00	B	C14NZ, X14SZ	
	44	03/93 → 09/00	B	C14NZ, X14SZ	
1.4 Si	60	03/93 → 09/00	B	C14SE	

**Kadett E, Station Wagon, Coupé, Cabrio, Van**

1.4 i	44	01/90 → 08/91	B	C14NZ	M →: 19.311.738
1.4 S	55	01/90 → 08/91	B	14NV	
	60	09/89 → 08/91	B	C14SE	M →: 19.311.738
1.6	60	09/86 → 12/91	B	16SV	M →: 19.311.738
1.6 i	55	08/91 → 07/94	B	C16NZ	M →: 19.311.738
	55	09/86 → 08/91	B	E16NZ	M →: 19.311.738
	60	07/89 → 02/93	B	16SV	M →: 19.311.738
1.6 i Cat.	55	09/86 → 08/91	B	C16LZ, C16NZ	M →: 19.311.738
1.6 S	60	09/86 → 08/91	B	16SV	M →: 19.311.738

**Vectra A**

1.4 S	55	09/88 → 06/92	B	14NV	M →: 19.307.806
1.6	60	09/88 → 05/93	B	16SV	M →: 2.122.350
1.6 i	52	09/93 → 11/95	B	X16SZ	M →: 2.122.350
	55	09/93 → 11/95	B	16LZ2	M →: 2.122.350
	55	09/88 → 11/95	B	16LZ2, C16LZ2, C16NZ, C16NZ2, E16NZ	M →: 2.122.350
1.6 i Cat.	55	09/88 → 11/95	B	C16NZ, C16NZ2	M →: 2.122.350
1.6 S	60	09/88 → 05/93	B	16SV	M →: 2.122.350

**81549 350981549000**

**OPEL**
**Vectra B, Station Wagon**

1.6 i	55	10/95 → 04/02	B	X16SZR	→ 12-1999, → M: 02MZ5253
	55	10/95 → 07/03	B	X16SZR	→ M: 02MZ5253

**VAUXHALL**
**CORSA**

1.2 16V	55	09/00 → 10/06	B	Z12XE	09-1996 →
---------	----	---------------	---	-------	-----------

**81550 350981550000**



**PULEGGIA**

Diametro Puleggia Ø62.3

Numero Denti/Gole Puleggia 25

Altezza Puleggia 26

Posizione Attacco 66.4

Diametro Girante Ø65

N° Alette Girante 8

Posizione Girante 29

**CHEVROLET**
**Captiva**

2.4	100	06/06 →	B	Z24SED	
2.4 4WD	100	06/06 →	B	Z24SED	
2.4 LPG	100	01/07 →		Z24SED	
2.4 LPG 4WD	100	01/07 →		Z24SED	

**Epica**

2.0	94	01/05 → 12/06	B	C20SED	
	98	01/05 → 12/06	B	T20SED	

**Evanda**

2.0	96	03/05 →	B	X20SED	
-----	----	---------	---	--------	--

**Lacetti**

1.8	67	03/05 → 12/09	B	F18D2	
	89	08/05 →	B	T18SED	

**Rezzo**

2.0	89	03/05 →	B	T20SED	
	90	08/05 →	B	T20SED	

**DAEWOO**
**Evanda**

2.0	96	08/02 →	B	L88, X20SED	
-----	----	---------	---	----------------	--

**Lacetti III, Hatchback**

1.8	90	02/04 →	B	T18SED	
1.8 CDX	90	08/03 → 12/04	B	T18SED	

81550

350981550000



KW



## DAEWOO

### Leganza

2.0 16V	93	07/00 → 04/04	B	T20SED	
	98	06/97 → 12/02	B	X20SED	
2.2 16V	100	04/99 → 12/02	B	T22SED	

### Magnus

2.0	96	07/99 →	B	X20SED	
-----	----	---------	---	--------	--

### Nubira I, Station Wagon

2.0	81	06/99 → 07/03	B	C20SED	
2.0 16V	93	12/00 →	B	T20SED	
	98	05/97 →	B	X20SED	
	98	05/97 →	B	X20SED, Z20L	

### Rezzo

2.0	89	09/01 →	B	X20SED	
	94	09/00 →	B	T20SED	

## LADA

### 110

2.0 i	110	08/96 →	B	C20XE	
-------	-----	---------	---	-------	--

## OPEL

### Antara

2.4	103	09/08 →	B	Z24XE	
	104	05/06 →	B	Z24XED	
2.4 4x4	103	01/07 →	B	Z24XE	
2.4 LPG	103	10/08 →		Z24XE	
2.4 LPG 4x4	103	10/08 →		Z24XE	

### Astra F, Station Wagon, Cabrio, Van

1.7 D	44	07/92 → 09/98	D	17DR	01-1993 →, M →: 14.363.652
1.7 TD	50	11/94 → 09/98	D	X17DTL	
1.8 i 16V	85	11/94 → 09/98	B	C18XEL, X18XE	
	92	06/93 → 10/94	B	C18XE	
2.0 GSI 16V	110	09/91 → 01/98	B	C20XE	01-1993 →, M →: 14.142.840
2.0 i 16V	100	02/95 → 09/98	B	X20XEV	
	110	03/93 → 01/98	B	C20XE	M →: 14.142.840

### Astra G, Station Wagon, Coupé, Cabrio, Van

1.7 TD	50	02/98 → 08/00	D	X17DTL	
1.8 16V	85	09/98 → 09/00	B	X18XE1	
2.0 16V	100	02/98 → 01/05	B	C20SEL, X20XEV	
	100	02/98 → 07/04	B	X20XEV	
	100	09/98 → 01/05	B	X20XEV	M →: 14.142.840
2.0 16V OPC	118	11/99 → 09/02	B	X20XER	

81550

350981550000



KW



## OPEL

### Astra G, Station Wagon, Coupé, Cabrio, Van

2.0 16V Turbo	140	09/00 → 08/01	B	Z20LET	
	141	08/01 → 05/05	B	Z20LET	
	147	11/02 → 10/05	B	Z20LER, Z20LET	
	147	11/02 → 05/05	B	Z20LET	
2.0 OPC	141	09/02 → 01/05	B	Z20LET	
	147	11/02 → 01/05	B	Z20LET	

### Astra H, Station Wagon, GTC, Twin Top, Van

2.0 Turbo	125	03/04 →	B	Z20LEL	
	147	09/04 →	B	Z20LER	
	177	03/05 →	B	Z20LEH	

### Calibra

2.0 i 16V	100	02/94 → 07/97	B	X20XEV	M →: 14.142.840
	110	06/90 → 02/94	B	C20XE	01-1993 →, M →: 14.142.839

### Calibra

2.0 i 16V 4x4	100	02/94 → 07/97	B	X20XEV	M →: 14.142.840
	110	06/90 → 02/94	B	C20XE	01-1993 →, M →: 14.142.839
2.0 i Turbo 4x4	150	03/92 → 07/97	B	C20LET	01-1993 →, M →: 14.002.935

### Frontera A

2.2 i	100	03/95 → 10/98	B	X22XE	
-------	-----	---------------	---	-------	--

### Frontera B

2.2 i	100	10/98 →	B	X22SE, Y22SE	
-------	-----	---------	---	-----------------	--

### Omega B, Station Wagon

2.0 16V	100	03/94 → 09/99	B	X20XEV	
2.2 16V	106	09/99 → 07/03	B	Y22XE, Z22XE	

### Sintra

2.2 i 16V	104	11/96 → 04/99	B	X22XE	
-----------	-----	---------------	---	-------	--

### Speedster

2.0 Turbo	147	04/03 →	B	Z20LET	
-----------	-----	---------	---	--------	--

### Vectra A

1.7 D	42	10/88 → 09/92	D	17D	M →: 14.333.450
	44	07/92 → 11/95	D	17DR	01-1993 →, M →: 14.333.450
	44	07/92 → 11/95	D	17DR	M →: 14.333.450
2.0 i 16V	100	06/94 → 11/95	B	X20XEV	M →: 14.142.839
	110	02/89 → 10/90	B	20XEJ	M →: 14.142.839
2.0 i 16V 4x4	100	06/94 → 11/95	B	X20XEV	M →: 14.142.839
2.0 i 16V Cat.	110	02/90 → 11/95	B	C20XE	M →: 14.142.839

**81550 350981550000**

**OPEL**
**Vectra A**

2.0 i Turbo 4x4	150	06/94 → 11/95	B	C20LET	M →: 14.002.935
2000 16V 4x4	110	01/89 → 10/90	B	20XEJ	M →: 14.142.839
2000/GT 16V	110	01/89 → 06/94	B	20XEJ	M →: 14.142.839
2000/GT 16V 4x4 Cat.	110	02/90 → 11/95	B	C20XE	M →: 14.142.839
2000/GT 16V Cat.	110	02/90 → 11/95	B	C20XE	M →: 14.142.839

**Vectra B, Station Wagon**

1.8 i 16V	85	10/95 → 09/00	B	X18XE1, Z18XEL	→ 12-1998, M: X18XE
	85	10/95 → 09/00	B	X18XE	
2.0 i 16V	100	10/95 → 09/00	B	C20SEL, X20XEV	

**Zafira A**

2.0 OPC	141	09/01 → 06/05	B	Z20LET	
	147	11/02 → 06/05	B	Z20LER, Z20LET	

**Zafira B, Van**

2.0	147	07/05 →	B	Z20LER	
	177	01/06 →	B	Z20LEH	

**81551 350981551000**

**PULEGGIA**

Diametro Puleggia Ø62.3

Numero Denti/Gole Puleggia 25

Altezza Puleggia 21

Posizione Attacco 64.4

Diametro Girante Ø65

N° Alette Girante 8

Posizione Girante 29

**OPEL**
**Astra F, Station Wagon, Cabrio, Van**

1.6	55	09/95 → 09/98	B	16LZ2, 16NZR	
1.8 i	66	03/92 → 09/98	B	C18NZ	11-1992 →, M →: 14.254.439

**81551 350981551000**

**OPEL**
**Astra F, Station Wagon, Cabrio, Van**

2.0 i	85	09/91 → 07/94	B	C20NE	01-1992 →, M →: 14.608.701
	85	03/92 → 09/98	B	C20NE	11-1992 →, M →: 14.608.701

**Astra F, Station Wagon, Cabrio, Van**

2.0 i	85	03/93 → 10/94	B	C20NE	M →: 14.608.701
-------	----	---------------	---	-------	-----------------

**Calibra**

2.0 i	85	06/90 → 07/97	B	C20NE	01-1993 →, M →: 14.608.701
2.0 i 4x4	85	06/90 → 07/97	B	C20NE	01-1993 →, M →: 14.608.701

**Frontera A**

2.0 i	85	03/92 → 10/98	B	C20NE, X20SE	M: X20SE
-------	----	---------------	---	--------------	----------

**Omega A, Station Wagon**

2.0	73	09/90 → 03/94	B	C20NEJ	
	74	09/90 → 03/94	B	C20NEF	M →: 14.608.701
	74	09/90 → 03/94	B	C20NEF	
2.0	90	09/86 → 03/94	B	20SE	01-1990 →, M →: 14.608.701
	90	09/86 → 03/94	B	20SE	01-1990 →, M →: 14.608.701
2.0 i	73	09/90 → 03/94	B	C20NEJ	
	85	09/86 → 03/94	B	C20NE	01-1990 →, M →: 14.608.701

**Omega B, Station Wagon**

2.0	85	03/94 → 12/00	B	20SE, X20SE	
	85	03/94 → 09/99	B	X20SE	

**Vectra A**

1.8 i	66	09/88 → 10/90	B	18SV	T →: P1.000.001
1.8 i Cat.	66	03/90 → 11/95	B	C18NZ	01-1993 →, T →: P1.000.001
1.8 S	66	09/89 → 10/90	B	18SV	T →: P1.000.001
2.0 i	85	09/88 → 10/90	B	20NE	T →: P1.000.001
	95	09/88 → 09/92	B	20SEH	T →: P1.000.001
2.0 i 4x4	85	01/89 → 10/90	B	20NE	T →: P1.000.001
	95	01/89 → 09/92	B	20SEH	T →: P1.000.001
2.0 i 4x4 Cat.	85	01/89 → 11/95	B	C20NE	T →: P1.000.001
2.0 i Cat.	85	09/88 → 11/95	B	C20NE	01-1993 →, T →: P1.000.001
2.0 i GT	95	09/88 → 11/95	B	20SEH	01-1993 →, T →: P1.000.001

## 81551 350981551000



### OPEL

#### Vectra B, Station Wagon

1.6 i	55	10/95 → 04/02	B	16LZ2	
2.0 i	82	10/95 → 04/02	B	20NEJ	

### VAUXHALL

#### OMEGA

2.0	85	09/95 → 09/96	B	20SE	
-----	----	---------------	---	------	--

## 81552 350981552000



### ALBERINO

Versione	BC
Diametro Alberino	M14×1.5
Tipo Filetto Alberino	Maschio
Posizione Attacco	148
Diametro Girante	Ø56
N° Alette Girante	6
Posizione Girante	12



### PEUGEOT

#### 305 II, Station Wagon

1.5	50	09/85 → 07/90	B	142 (XR5A)	VA, BC
-----	----	---------------	---	------------	--------

## 81554 350981554000



### PULEGGIA

Diametro Puleggia	Ø59.26
Numero Denti/Gole Puleggia	20
Altezza Puleggia	33.5
Posizione Attacco	42.5
Diametro Girante	Ø60
N° Alette Girante	6
Posizione Girante	40



### CITROËN

#### BX, Break

1.6	85	01/87 → 01/92	B	B6D, B6E	
1.8 D	44	10/85 → 09/93	D	161 (XUD7)	→ 12-1986, → PROD: 3583
1.9 GTi	117	01/90 → 01/92	B		→ PROD: 5409

## 81554 350981554000



### CITROËN

#### BX, Break

16	53	01/87 → 02/93	B	B1E (XU51C)	→ 01-1992, → PROD: 5409
	55	09/88 → 02/93	B	BAY (XU5CP), BAZ (XU5CP)	→ 01-1992, → PROD: 5409
	58	09/87 → 02/93	B	B1A (XU51C/K)	→ 01-1992, → PROD: 5409
	64	07/85 → 02/93	B	171D	→ 01-1992, → PROD: 5409
	65	05/89 → 12/94	B	BDY (XU5M), BDZ (XU5M)	→ 01-1992, → PROD: 5409
	68	10/82 → 12/92	B	XU52C	→ 01-1992, → PROD: 5409
	76	03/86 → 02/93	B	180Z	→ 01-1992, → PROD: 5409
16 E	65	05/89 → 02/93	B	BDY (XU5M), BDZ (XU5M)	→ 01-1992, → PROD: 5409
18 D	44	10/85 → 09/93	D	161A (XUD7)	→ 12-1986, → PROD: 3583
19	75	07/86 → 12/94	B	D2A (XU92C)	→ 01-1992, → PROD: 5409
	80	06/88 → 12/94	B	DDZ (XU9M)	→ 01-1992, → PROD: 5409
	88	06/88 → 12/94	B	DKZ (XU9JA)	→ 01-1992, → PROD: 5409
19 4x4	80	10/90 → 05/91	B	DDZ (XU9M)	→ PROD: 5.409
19 Cat.	75	07/86 → 12/94	B	DFZ (XU9J1)	→ 01-1992, → PROD: 5409
19 D	47	09/83 → 09/93	D	162 (XUD9), D9A (XUD9), DJZ (XUD9Y)	→ 12-1986, → PROD: 3583
19 E	80	06/88 → 02/93	B	DDZ (XU9M)	→ 01-1992, → PROD: 5409
19 E 4x4	80	04/89 → 02/93	B	D2F	→ 01-1992, → PROD: 5409
19 GTi	88	06/88 → 02/93	B	DKZ (XU9JA)	→ 01-1992, → PROD: 5409
	90	07/86 → 02/93	B	D6A (XU9J2)	→ 01-1992, → PROD: 5409
19 GTi 16V	108	03/88 → 02/93	B	DFW (XU9J4)	→ 01-1992, → PROD: 5409
19 GTi 4x4	88	06/88 → 02/93	B	DKZ (XU9JA)	→ 01-1992, → PROD: 5409

**81554 350981554000**

**CITROËN**
**C 15**

1.8 D	44	07/86 → 12/00	D	161A(XUD7)	→ PROD: 3583
-------	----	---------------	---	------------	--------------

**Visa, Cabrio**

17 D	44	04/84 → 03/91	D	161A(XUD7)	→ 12-1986, → PROD: 3583
------	----	---------------	---	------------	----------------------------

**ZX, Break**

1.6 i	65	03/91 → 06/97	B	BDY (XU5M), BFZ (XU5JP)	→ 08-1992, → PROD: 5409
-------	----	---------------	---	----------------------------	----------------------------

1.8 i	74	07/92 → 06/97	B	LFZ (XU7JP)	→ PROD: 5409
-------	----	---------------	---	-------------	--------------

1.9 i	88	03/91 → 06/97	B	DKZ (XU9JA)	→ 08-1992, → PROD: 5409
-------	----	---------------	---	-------------	----------------------------

**PEUGEOT**
**205 I, Van, Cabrio**

1.6	85	08/87 → 07/92	B	B6D (XU5JA)	
-----	----	---------------	---	-------------	--

1.6 CTI	76	04/86 → 10/90	B	180A (XU5J), 180Z (XU5J)	
---------	----	---------------	---	-----------------------------	--

1.9 CTI	75	10/87 → 12/94	B	DFZ (XU9J1)	→ 12-1991
---------	----	---------------	---	-------------	-----------

1.9 CTi	92	08/90 → 07/92	B	DKZ (XU9JAZ)	
---------	----	---------------	---	--------------	--

**205 II, Van**

	53	10/87 → 09/98	B	B1E (XU51C)	
--	----	---------------	---	-------------	--

1.6	55	10/87 → 09/98	B	B1A(XU51C), BAZ (XU5CP)	
-----	----	---------------	---	----------------------------	--

1.6 Aut.	58	10/87 → 09/98	B		→ 12-1991
----------	----	---------------	---	--	-----------

1.9 GTI	88	10/87 → 10/94	B	DKZ (XU9JAZ)	→ 12-1991
---------	----	---------------	---	--------------	-----------

	94	10/87 → 09/98	B	D6B (XU9JA)	→ 12-1991
--	----	---------------	---	-------------	-----------

1.9 GTI Cat.	75	10/87 → 07/94	B	DFZ (XU9J1)	→ 12-1991
--------------	----	---------------	---	-------------	-----------

**309 II**

1.6	65	07/89 → 12/93	B	BDY (XU5M2Z), BDY (XU5M3Z), BDZ (XU5M)	→ 01-1992
-----	----	---------------	---	--	-----------

	68	07/89 → 12/93	B	B2A (XU52C/K)	→ 01-1992
--	----	---------------	---	---------------	-----------

	69	07/89 → 12/93	B	B2A (XU52C/K)	→ 01-1992
--	----	---------------	---	---------------	-----------

1.6 GTi	85	09/89 → 10/93	B		→ 01-1992
---------	----	---------------	---	--	-----------

1.9	72	08/89 → 12/93	B	DFZ (XU9J1)	→ 01-1992
-----	----	---------------	---	-------------	-----------

	80	10/90 → 12/93	B	DDZ (XU9M)	→ 01-1992
--	----	---------------	---	------------	-----------

1.9 GTI	88	07/89 → 12/93	B	DKZ (XU9JAZ)	→ 01-1992
---------	----	---------------	---	--------------	-----------

**81554 350981554000**

**CITROËN**
**405 I, Station Wagon**

	53	07/87 → 12/92	B	B1E (XU51C)	
--	----	---------------	---	-------------	--

	55	10/88 → 08/92	B	BAZ (XU5CP)	
--	----	---------------	---	-------------	--

1.6	65	10/88 → 08/92	B	BDY (XU5M2Z), BDY (XU5M3Z), BDZ (XU5M)	
-----	----	---------------	---	--	--

	65	07/87 → 12/92	B	BDY (XU5M2Z), BDZ (XU5M)	
--	----	---------------	---	-----------------------------	--

	66	10/89 → 12/92	B	BDZ (XU5M)	
--	----	---------------	---	------------	--

	69	01/87 → 12/92	B	B2A (XU52C/K)	
--	----	---------------	---	---------------	--

	69	10/88 → 08/92	B		
--	----	---------------	---	--	--

1.6 4x4	65	04/88 → 07/92	B	BDZ (XU5M)	
---------	----	---------------	---	------------	--

1.6 SRi 4x4	65	04/88 → 07/92	B	BDZ (XU5M)	
-------------	----	---------------	---	------------	--

	70	07/87 → 12/92	B	D2C (XU92C)	
--	----	---------------	---	-------------	--

	77	10/88 → 08/92	B	DFZ (XU9J1)	
--	----	---------------	---	-------------	--

1.9	80	07/88 → 12/92	B	DDZ (XU9M)	
-----	----	---------------	---	------------	--

	88	07/88 → 12/92	B	DKZ (XU9JAZ)	
--	----	---------------	---	--------------	--

	93	07/87 → 12/93	B	D6A (XU9J2)	
--	----	---------------	---	-------------	--

1.9 4x4	80	07/88 → 12/92	B	DDZ (XU9M)	
---------	----	---------------	---	------------	--

	88	06/87 → 07/92	B	DKZ (XU9JAZ)	
--	----	---------------	---	--------------	--

	93	07/90 → 07/92	B		
--	----	---------------	---	--	--

1.9 Injection	77	07/87 → 12/92	B	DFZ (XU9J1)	
---------------	----	---------------	---	-------------	--

**81556 350981556000**

**PULEGGIA**

Diametro Puleggia	Ø59.26
-------------------	--------

Numero Denti/Gole Puleggia	20
----------------------------	----

Altezza Puleggia	33.5
------------------	------

Posizione Attacco	43
-------------------	----

Diametro Girante	Ø53.3
------------------	-------

N° Alette Girante	6
-------------------	---

Posizione Girante	41.85
-------------------	-------

**CITROËN**
**AX**

1.4 4x4	62	09/86 → 07/92	B	K2A	
---------	----	---------------	---	-----	--

1.4 D 4x4	39	06/91 → 07/92	D	K9A (TUD3)	
-----------	----	---------------	---	------------	--

1.4 GTi	74	06/91 → 12/92	B	KFZ (TU3FJ2)	→ PROD: 5.278
---------	----	---------------	---	--------------	---------------

**81556**
**350981556000**

**KW**

**CITROËN**
**AX**

10	32	09/86 → 06/92	B	C1A	
	33	07/86 → 12/98	B	CDY (TU9M)	
	37	02/87 → 12/98	B	CDZ (TU9M)	
11	40	12/86 → 04/94	B	H1A, H1B	12-1986 →
	44	09/86 → 12/97	B	H1B, HDZ (TU1M)	
11 4x4	40	06/91 → 07/92	B	H1A	
14	55	04/87 → 04/97	B	KDX (TU3M/Z), KDY (TU3FM), KDY (TU3M), KDZ (TU3M/Z)	→ 12-1993
	62	01/88 → 12/92	B	K2A, K2B	
14 D	37	08/91 → 12/97	D	K9Y (TUD3Y)	01-1993 →
	38	09/88 → 06/92	D	K9A (TUD3)	

**Berlingo I, Van**

1.1 i	44	07/96 →	B	HDZ (TU1M), HFX (TU1JP)	→ M: 3.762.433
1.4 i	55	07/96 →	B	KFW (TU3JP), KFX (TU3JP)	→ M: 3.666.765

**BX, Break**

11	40	10/88 → 06/92	B	HDZ (TU1M)	10-1989 →, PROD →: 4193
	42	10/86 → 06/92	B	H1A	10-1989 →, PROD →: 4193
14	53	01/86 → 02/93	B	150C	10-1989 →, → 01-1992, PROD →: 4193, → PROD: 5440
14	55	01/89 → 02/93	B	KDY (TU3M)	10-1989 →, → 01-1992, PROD →: 4193, → PROD: 5440
	55	01/89 → 02/93	B	KDY (TU3M), KDZ (TU3M/Z)	10-1989 →, → 01-1992, PROD →: 4193, → PROD: 5440

**81556**
**350981556000**

**KW**

**CITROËN**
**BX, Break**

14 E	49	09/85 → 02/93	B	150F	10-1989 →, → 01-1992, PROD →: 4193, → PROD: 5440
	53	04/83 → 02/93	B	150C	10-1989 →, → 01-1992, PROD →: 4193, → PROD: 5440

**C 15**

1.0	33	10/84 → 12/97	B	TU9, XV8	01-1989 →, PROD →: 4193
1.0 E	37	11/92 → 07/96	B	TU9K	PROD →: 4193
1.1	35	10/84 → 12/96	B	109K, E1A	01-1989 →, PROD →: 4193
	40	11/88 → 07/96	B	H1A	
1.1 i	44	07/88 → 12/96	B	HDZ (TU1M)	
1.4	49	07/87 → 12/96	B	K1H (TU3A)	PROD →: 4193
1.4 E	40	07/87 → 12/96	B	K3A	PROD →: 4193
	44	05/87 → 12/96	B	150D (XY7)	PROD →: 4193
1.4 i	55	05/91 → 12/96	B	KDY (TU3FM), KDY (TU3M)	PROD →: 4193

**Saxo**

1.0 X	33	05/96 → 11/98	B	CDZ (TU9M)	
	37	05/98 → 06/03	B	CDZ (TU9M)	
1.1 X, SX	40	05/96 → 09/03	B	HDZ (TU1M)	→ 07-2000, → M: 3.666.765
	44	05/96 → 09/03	B	HDZ (TU1M), HFX (TU1JP)	→ 07-2000, → M: 3.666.765
1.4 VTS	55	05/96 → 06/03	B	KFW (TU3JP), KFX (TU3JP)	→ 07-2000, → M: 3.666.765

**Xsara, Break, Coupé, Picasso, Van**

1.4 i	55	04/97 → 03/05	B	KFW (TU3JP), KFX (TU3JP)	→ 08-2000, → M: 3.666.765
	55	10/97 → 08/05	B	KFW (TU3JP), KFX (TU3JP)	→ M: 3.666.765

**ZX, Break**

1,1	40	03/91 → 08/93	B	H1A, H1B	
	44	03/91 → 06/97	B	HDZ (TU1M)	
1.4	55	03/91 → 06/97	B	KDZ (TU3M/Z)	

**81556 350981556000**

**CITROËN**
**ZX, Break**

1.4 D	37	07/94 → 10/97	D	K9Y (TUD3Y)	
1.4 i	55	10/93 → 10/97	B	KDX (TU3M/Z), KDY (TU3M), KFX (TU3JP)	07-1994 →, → 07-1995
	55	03/91 → 06/97	B	KDX (TU3M/Z), KDZ (TU3M/Z), KFX (TU3JP)	

**MEGA**
**Club I**

1.1 i	44	01/92 → 06/99	B	TU1MC	
-------	----	---------------	---	-------	--

**PEUGEOT**
**106 I, Van**

1.0	33	09/91 → 04/96	B	CDY (TU9M), TU9	
	37	09/91 → 04/96	B	CDZ (TU9M)	
1.1	44	09/91 → 04/96	B	HDZ (TU1M)	
1.3	72	10/93 → 04/96	B	TU2J2	
1.4	51	08/91 → 03/96	B	K5A (TU3)	
	55	09/91 → 04/96	B	KDX (TU3MC), KDY (TU3M)	
	69	09/91 → 04/96	B	KFZ (TU3J2/Z)	
1.4 D	37	09/92 → 04/96	D	K9Y (TUD3Y)	
1.6	65	06/93 → 04/96	B	NFZ (TU5JP)	

**106 II**

1.0 i	33	05/96 →	B	CDY (TU9M)	
	37	01/97 →	B	CDZ (TU9M)	
1.1 i	40	01/97 →	B	HDY (TU1M)	
	44	05/96 →	B	HDZ (TU1M), HFX (TU1JP)	
1.4 i	55	05/96 →	B	KFW (TU3JP), KFX (TU3JP)	
1.6 i	65	05/96 →	B	NFZ (TU5JP)	

**205 I, Van, Cabrio**

1.1 CJ	44	10/89 → 12/94	B	HDZ (TU1M)	
	49	03/89 → 12/94	B	K1D (TU3A)	
1.4 CJ	55	05/91 → 12/94	B	KDY (TU3M), KDZ (TU3M)	

**81556 350981556000**

**PEUGEOT**
**205 II, Van**

1.0	33	10/87 → 09/98	B	TU9	
	37	08/92 → 05/97	B	CDZ (TU9M)	
1.1	40	10/87 → 10/90	B	H1B (TU1)	
	40	08/98 → 07/00	B	HFX (TU1JP)	→ M: 3.762.433
	44	07/89 → 09/98	B	HDZ (TU1M)	
1.1 i	44	09/98 →	B	HFX (TU1JP), HFX (TU1JP)	→ M: 3.762.433
1.3 Rallye	74	10/87 → 10/90	B	TU24	
	49	10/87 → 10/90	B	K1D (TU3A)	
1.4	55	07/88 → 09/98	B	KDY (TU3M), KDZ (TU3M), KFX (TU3JP)	
	44	08/87 → 09/93	B	KAY (TU3CP)	
1.4 i	55	09/98 →	B	KFW (TU3JP), KFX (TU3JP)	→ M: 3.666.765
1.4 LPG	55	05/06 → 09/07		KFV (TU3JP)	

**206, CC, Van**

1.1	44	07/02 →	B	HFX (TU1JP)	→ M: 3.762.433
1.4	55	07/02 →	B	KFV (TU3A), KFW (TU3JP)	→ M: 3.666.765

**306, Station Wagon, Coupé, Cabrio, Van**

1.1	44	06/94 → 05/01	B	HDZ (TU1M)	
1.4	55	05/93 → 05/01	B	KDX (TU3MC), KFW (TU3JP), KFX (TU3JP)	→ M: 3.666.765
	55	03/97 → 04/02	B	KFW (TU3JP), KFX (TU3JP)	→ M: 3.666.765
1.4 SL	55	06/94 → 05/01	B	KDX (TU3MC), KFW (TU3JP), KFX (TU3JP)	→ M: 3.666.765

**307, Station Wagon, CC**

1.4	55	08/00 →	B	KFW (TU3JP)	→ M: 3.666.765
-----	----	---------	---	-------------	----------------

**309 II**

1.1	44	08/90 → 12/93	B	HDZ (TU1M)	
	49	07/90 → 12/93	B	K1D (TU3A)	
1.4	55	07/89 → 12/93	B	KDY (TU3M), KDZ (TU3M)	

**81556**
**350981556000**

**PEUGEOT**
**405 I, Station Wagon**

1.4	47	01/87 → 07/92	B	K5A (TU3)	
-----	----	---------------	---	-----------	--

**Partner I**

1.1	44	06/96 →	B	HDZ (TU1M)	→ 10-2002
	44	06/96 →	B	HDZ (TU1M), HFX (TU1JP)	→ 10-2002

1.4	55	06/96 →	B	KFW (TU3JP), KFX (TU3JP), TU32	→ 10-2002
	55	06/96 →	B	KFX (TU3JP), TU32	→ 10-2002

1.4 BiFuel	55	04/03 →	BF	KFW (TU3JP)	→ M: 3.666.765
------------	----	---------	----	-------------	----------------

<b>ROVER</b>					
<b>100 (Metro)</b>					
114 D	38	10/92 → 12/94	D	TUD3	
115 D	42	12/94 → 12/98	D	TUD5	

**81559**
**350981559000**

<b>FLANGIA</b>	
Numero Fori Flangia	4
Dimensione Fori Flangia	M6×1
Posizione Attacco	83.5
Diametro Mozzo	Ø28.05
Diametro Girante	Ø60
N° Alette Girante	6
Posizione Girante	14

**FORD**
**Transit IV**

2.5 D	50	01/86 → 09/91	D	4AB	
	52	09/88 → 09/92	D	4AB, 4BA, 4CA	
	52	10/88 → 09/91	D	4BA, 4CA	

2.5 DI	52	09/88 → 09/92	D	4BA, 4CA	
--------	----	---------------	---	----------	--

<b>Transit Tourneo I</b>					
2.4 D	55	08/94 → 06/00	D	4HA	

2.5 DI	51	11/94 → 12/00	D	4FA, 4FB, 4FC, 4FD	
	56	11/94 → 12/00	D	4HA, 4HB, 4HC	

2.5 TD	63	11/94 → 12/00	D	4GA, 4GB, 4GC	
--------	----	---------------	---	---------------	--

**81559**
**350981559000**

**CITROËN**
**Transit Tourneo I**

2.5 TD	74	04/98 → 12/00	D	4EB, 4EC	
--------	----	---------------	---	----------	--

**Transit V**

2.5 DI	51	09/91 → 08/94	D	4AB, 4BC, 4CC, 4FA	
	51	08/91 → 07/94	D	4BC, 4CC, 4FA	
	59	09/91 → 07/94	D	4DA	

2.5 TD	63	10/92 → 06/94	D	4GA	
	63	10/92 → 07/94	D	4GA, 4GB, 4GC	

2.5 TD	74	09/91 → 07/94	D	4EA	
--------	----	---------------	---	-----	--

<b>Transit VI</b>					
2.5 DI	51	08/94 → 03/00	D	4FA, 4FB, 4FC, 4FD	
	56	07/94 → 03/00	D	4HB, 4HC	
	85	08/97 → 03/00	D	4ED	

2.5 TD	55	08/94 → 06/00	D	4HA, 4HD	
	63	01/95 → 03/00	D	4GA, 4GB, 4GC, 4GD, 4GE, 4GF	

2.5 TD	74	07/94 → 03/00	D	4EB, 4EC	
	74	06/94 → 03/00	D	4EB, 4EC	

2.5 TDI	74	06/94 → 03/00	D	4EB, 4EC	
---------	----	---------------	---	----------	--

**81560**
**350981560000**

<b>FLANGIA</b>	
Numero Fori Flangia	3
Dimensione Fori Flangia	M7×1
Posizione Attacco	70
Diametro Girante	Ø51.5
N° Alette Girante	6
Posizione Girante	33

**CITROËN**
**C 15**

1.1	35	10/84 → 12/96	B	109K, E1A	→ 12-1988, → PROD: 4237
-----	----	---------------	---	-----------	----------------------------

<b>PEUGEOT</b>					
<b>205 II, Van</b>					
1.2	47	01/87 → 12/90	B	F1	
1.3	47	08/90 → 07/92	B	G1A	

1.6 GTX	69	01/87 → 10/91	B		
---------	----	---------------	---	--	--



**81560 350981560000**

**PEUGEOT**
**309 II**

1.1	40	09/89 → 10/93	B	H1B (TU1)
-----	----	---------------	---	-----------

**81572 350981572000**

**PULEGGIA**

Diametro Puleggia	Ø121
Numero Denti/Gole Puleggia	1
Posizione Attacco	106
Diametro Girante	Ø53
N° Alette Girante	6
Posizione Girante	11.5

**CITROËN**
**BX, Break**

11	40	10/88 → 06/92	B	HDZ (TU1M)	→ 09-1989, → PROD: 4192
	42	10/86 → 06/92	B	H1A	→ 09-1989, → PROD: 4192

14	53	01/86 → 02/93	B	150C	→ 09-1989, → PROD: 4192
	55	01/89 → 02/93	B	KDY (TU3M)	→ 09-1989, → PROD: 4192

14	55	01/89 → 02/93	B	KDY (TU3M), KDZ (TU3M/Z)	→ 09-1989, → PROD: 4192
----	----	---------------	---	-----------------------------	----------------------------

14 E	49	09/85 → 02/93	B	150F	→ 09-1989, → PROD: 4192
	53	04/83 → 02/93	B	150C	→ 09-1989, → PROD: 4192

14 E	53	04/83 → 02/93	B	150C	→ 09-1989, → PROD: 4192
------	----	---------------	---	------	----------------------------

14 E	53	04/83 → 02/93	B	150C	→ 09-1989, → PROD: 4192
------	----	---------------	---	------	----------------------------

14 E	53	04/83 → 02/93	B	150C	→ 09-1989, → PROD: 4192
------	----	---------------	---	------	----------------------------

**C 15**

1.0	33	10/84 → 12/97	B	TU9, XV8	→ 12-1988, → PROD: 4192
-----	----	---------------	---	----------	----------------------------

1.0 E	37	11/92 → 07/96	B	TU9K	→ PROD: 4192
-------	----	---------------	---	------	--------------

1.1	35	10/84 → 12/96	B	109K, E1A	→ PROD: 4192
-----	----	---------------	---	-----------	--------------

1.4	49	07/87 → 12/96	B	K1H (TU3A)	→ PROD: 4192
-----	----	---------------	---	------------	--------------

1.4 E	40	07/87 → 12/96	B	K3A	→ PROD: 4192
-------	----	---------------	---	-----	--------------

1.4 E	44	05/87 → 12/96	B	150D (XY7)	→ PROD: 4192
-------	----	---------------	---	------------	--------------

1.4 i	55	05/91 → 12/96	B	KDY (TU3FM), KDY (TU3M)	→ PROD: 4192
-------	----	---------------	---	----------------------------	--------------

1.4 i	55	05/91 → 12/96	B	KDY (TU3FM), KDY (TU3M)	→ PROD: 4192
-------	----	---------------	---	----------------------------	--------------

1.4 i	55	05/91 → 12/96	B	KDY (TU3FM), KDY (TU3M)	→ PROD: 4192
-------	----	---------------	---	----------------------------	--------------

**81572 350981572000**

**CITROËN**
**Visa, Cabrio**

11 E	37	07/82 → 03/91	B	109/5F
------	----	---------------	---	--------

14	44	07/84 → 03/91	B	150D (XY7)
----	----	---------------	---	------------

14 GT	58	03/82 → 03/91	B	150B (XY8)
-------	----	---------------	---	------------

**PEUGEOT**
**205 I, Van, Cabrio**

1.4	62	08/87 → 06/94	B	K2B (TU3S)
-----	----	---------------	---	------------

1.4 CJ Cat.	44	01/89 → 09/93	B	KAY (TU3CP)
-------------	----	---------------	---	-------------

**205 II, Van**

1.1	36	10/87 → 10/90	B	109N (XW7)
-----	----	---------------	---	------------

**81573 350981573000**

**PULEGGIA**

Diametro Puleggia	Ø144
Numero Denti/Gole Puleggia	1
Posizione Attacco	29.5
Diametro Girante	Ø67
N° Alette Girante	8
Posizione Girante	18

**RENAULT**
**19 I, Chamade, Cabrio**

1.2	40	01/88 → 12/92	B	C1G730	(-)COP
-----	----	---------------	---	--------	--------

	43	07/88 → 04/92	B	C2J772, C3J710	(-)COP
--	----	---------------	---	-------------------	--------

1.4	43	01/89 → 04/92	B	C2J772, C3J710	(-)COP, 07-1988 →, → 04-1992
-----	----	---------------	---	-------------------	------------------------------------

1.4	43	01/89 → 04/92	B	C2J772, C3J710	(-)COP, 07-1988 →, → 04-1992
-----	----	---------------	---	-------------------	------------------------------------

1.4	43	01/89 → 04/92	B	C2J772, C3J710	(-)COP, 07-1988 →, → 04-1992
-----	----	---------------	---	-------------------	------------------------------------

1.4	43	01/89 → 04/92	B	C2J772, C3J710	(-)COP, 07-1988 →, → 04-1992
-----	----	---------------	---	-------------------	------------------------------------

**19 II, Chamade, Cabrio**

1.2	40	04/92 → 12/95	B	C1G730	(-)COP
-----	----	---------------	---	--------	--------

1.4	43	04/92 → 12/95	B	C3J710	(-)COP
-----	----	---------------	---	--------	--------

**21, Station Wagon**

1.4	51	09/89 → 05/93	B	C2J770	(-)COP
-----	----	---------------	---	--------	--------

**Clio I**

	34	01/91 → 09/98	B	C1E700	(-)COP
--	----	---------------	---	--------	--------

	34	01/91 → 09/98	B	C1E700	(-)COP, → 05-1994, M: C1E700
--	----	---------------	---	--------	------------------------------------

1.1	34	01/91 → 09/98	B	C1E700	(-)COP, → 05-1994, M: C1E700
-----	----	---------------	---	--------	------------------------------------

1.1	34	01/91 → 09/98	B	C1E700	(-)COP, → 05-1994, M: C1E700
-----	----	---------------	---	--------	------------------------------------

1.1	34	01/91 → 09/98	B	C1E700	(-)COP, → 05-1994, M: C1E700
-----	----	---------------	---	--------	------------------------------------

1.1	34	01/91 → 09/98	B	C1E700	(-)COP, → 05-1994, M: C1E700
-----	----	---------------	---	--------	------------------------------------

1.1	34	01/91 → 09/98	B	C1E700	(-)COP, → 05-1994, M: C1E700
-----	----	---------------	---	--------	------------------------------------

**81573**
**350981573000**

**KW**

**RENAULT**
**Rapid**

1.0	27	02/86 → 05/92	B	C1C706	(-)COP, (-)AC
1.1	33	07/85 → 04/95	B	C1E750, C1E752, C1E754, C1E756, C1E760, C1E762, C1E792	(-)COP, (-)AC
1.2	40	09/91 → 03/98	B	C3G710, C3G712	(-)COP, (-)AC
1.4	43	07/85 → 03/98	B	C1J768, C1J780, C3J700, C3J702, C3J760, C3J762	(-)COP, (-)AC
	44	03/86 → 08/91	B	C2J784	(-)COP, (-)AC

**Super 5**

1.1	33	01/86 → 03/95	B	C1E750, C1E752, C1E756, C1E760	(-)COP, (-)AC
	34	10/84 → 12/96	B	C1E750, C1E752, C1E754	(-)COP, (-)AC
1.2	40	01/87 → 08/90	B	C1G702, C1G720, C1G722	(-)COP, (-)AC
	44	01/87 → 12/96	B	C1G702	(-)COP, (-)AC
1.4	43	10/84 → 12/96	B	C1J768, C1J780, C3J700, C3J702, C3J760	(-)COP, (-)AC
	44	06/87 → 08/90	B	C2J784	(-)COP, (-)AC
1.4 Turbo	88	04/85 → 08/90	B	C1J782, C1J784, C1J788	(-)COP, (-)AC
1.4 Turbo GT	118	01/85 → 05/91	B	840730	(-)COP, (-)AC

**81574**
**350981574000**

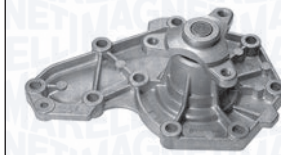
**KW**

**FLANGIA**

Numero Fori Flangia	3
Dimensione Fori Flangia	M8×1.25
Posizione Attacco	57
Diametro Mozzo	Ø28
Diametro Centraggio	Ø50
Diametro Girante	Ø61.8
N° Alette Girante	8
Posizione Girante	24

**KW**

**DACIA**
**Solenza**

1.9 D	46	02/03 →	D	F8Q630
-------	----	---------	---	--------

**MITSUBISHI**
**Carisma**

1.9 TD	66	10/96 → 09/00	D	F8QT
--------	----	---------------	---	------

**OPEL**
**Arena**

1.9 D	44	01/97 → 12/01	D	19DJ, 19DL
	44	03/98 → 08/01	D	F8Q600, F8Q606

**Movano A**

1.9 DTI	59	09/00 → 10/01	D	F9Q770
---------	----	---------------	---	--------

**RENAULT**
**19 I, Chamade, Cabrio**

1.7	55	07/91 → 04/92	B	F2N724
	70	07/91 → 04/92	B	F3N742, F3N743
	54	09/88 → 04/92	B	F3N740, F3N741
	66	09/88 → 04/92	B	F3N742, F3N743
	79	08/88 → 12/92	B	F3N746
1.8 16V	99	06/89 → 04/92	B	F7P704
	101	07/91 → 04/92	B	F7P700, F7P704
1.9 D	48	01/88 → 12/92	D	F8Q706, F8Q742
	47	09/88 → 04/92	D	F8Q706, F8Q742
1.9 DT	68	09/90 → 04/92	D	F8Q610
1.9 TD	68	09/90 → 04/92	D	F8Q740

**19 II, Chamade, Cabrio**

1.7	54	04/92 → 12/95	B	F3N740, F3N741
	66	04/92 → 09/93	B	F3N742, F3N743
	66	04/92 → 12/95	B	F3N743

**81574**
**350981574000**

**KW**

**RENAULT**
**19 II, Chamade, Cabrio**

1.8	79	05/94 → 12/95	B	F3P682
	65	04/92 → 06/96	B	F3P704, F3P705, F3P706, F3P707, F3P708, F3P760
	65	04/92 → 12/95	B	F3P706, F3P707, F3P708, F3P760
	66	04/92 → 12/95	B	F3P706, F3P760
	79	07/94 → 06/96	B	F3P682, F3P764, F3P765
	79	05/94 → 12/95	B	F3P682, F3P765
	81	04/92 → 05/94	B	F3P700
	1.8 16V	99	04/92 → 12/95	B
1.9 D	48	03/92 → 12/95	D	F8Q706, F8Q742
	47	04/92 → 12/95	D	F8Q742
1.9 dT	68	03/92 → 12/95	D	F8Q740
	66	04/92 → 12/95	D	F8Q744

**21, Station Wagon**

1.7	65	06/86 → 04/95	B	F2N710
	54	06/86 → 06/93	B	F2N750, F3N726
	54	09/89 → 10/92	B	F3N726
	55	06/86 → 03/93	B	F2N712
	65	03/86 → 03/93	B	F2N710
	66	09/89 → 06/94	B	F3N722, F3N723
	69	03/86 → 02/94	B	F3N722, F3N723
1.9 D	47	06/86 → 08/94	D	F8Q710
	47	09/89 → 01/94	D	F8Q710

**Clio I**

1.7	68	01/91 → 12/93	B	F2N770
1.8	70	01/91 → 09/98	B	F3P710
	65	01/91 → 09/98	B	F3P710, F3P714
	66	08/94 → 09/98	B	F3P754, F3P755
1.8 16V	99	01/91 → 03/96	B	F7P722

**81574**
**350981574000**

**KW**

**RENAULT**
**Clio I**

1.8 Rsi	79	08/95 → 09/98	B	F3P758
	80	01/93 → 08/95	B	F3P712
1.9 D	40	01/97 → 09/98	D	F8Q678
	48	01/91 → 09/98	D	F8Q730, F8Q732
	47	01/91 → 09/98	D	F8Q730, F8Q732
1.9 RND	40	04/96 → 02/98	D	F8Q678
Williams	108	01/94 → 09/98	B	F7R700

**Clio II**

1.9 D	47	09/98 → 05/05	D	F8Q630
	48	02/00 → 05/01	D	F8Q630, F8Q632
	48	02/00 → 05/01	D	F8Q632
1.9 dTi	59	12/99 → 05/05	D	F9Q780
2.0 16V Sport	132	01/04 →	B	F4R738
	124	02/00 →	B	F4R730, F4R736

**Espace III**

1.9 dTi	72	02/99 → 10/02	D	F9Q722
2.0	102	09/01 → 10/02	B	F4R700, F4R701
	84	11/96 → 10/00	B	F3R728, F3R729, F3R742, F3R768, F3R769
2.0 16V	103	10/98 → 10/02	B	F4R700, F4R701

**Kangoo I, Van**

1.9 D	48	09/99 → 06/03	D	F8Q632
1.9 dCi	62	07/03 →	D	F9Q782, F9Q790
	62	10/03 →	D	F9Q790
1.9 dCi 4x4	59	10/01 →	D	F9Q782, F9Q790
	62	07/03 →	D	F9Q790
	59	02/00 →	D	F9Q780
1.9 dTi	59	02/00 →	D	F9Q780, F9Q782
	48	09/99 → 06/01	D	F8Q630, F8Q632
D 55 1.9	40	08/97 →	D	F8Q662
D 65 1.9	47	08/97 →	D	F8Q630, F8Q632

**81574**
**350981574000**

**KW**

**RENAULT**
**Laguna I, Grantour**

1.8	69	06/95 → 02/01	B	F3P674	
	70	06/95 → 06/98	B	F3P676	
	66	08/95 → 03/01	B	F3P670, F3P678	
	66	11/93 → 03/01	B	F3P720, F3P724	
	69	08/95 → 03/01	B	F3P720, F3P724	
1.8 16V	88	04/98 → 03/01	B	F4P760	
	88	04/98 → 03/01	B	F4P760, F4P770	
1.9 dTi	72	10/97 → 03/01	D	F9Q710, F9Q716, F9Q717	
2.0	70	11/93 → 03/01	B		
	80	03/99 → 03/01	B	F3R611	
	84	06/95 → 02/01	B	F3R722, F3R768	
	84	10/98 → 01/01	B	F3R728, F3R768	
	83	11/93 → 03/01	B	F3R722, F3R723	
	102	09/99 → 02/01	B	F4R780	

**Master II**

1.9 dTi	59	09/00 →	D	F9Q770	
---------	----	---------	---	--------	--

**Megane I, Coach, Cabrio, Scénic, Station Wagon**

1.8 16V	85	01/01 → 08/03	B	F4P720, F4P722	
1.9 D	69	04/96 → 02/01	D	F8Q784	
	47	09/96 → 08/03	D	F8Q620, F8Q624	
	47	04/99 → 08/03	D	F8Q622, F8Q790	
	47	03/97 → 09/99	D	F8Q790	
1.9 D Eco	47	01/96 → 08/03	D	F8Q620, F8Q624	
1.9 dCi	77	03/99 → 09/00	D	F9Q733	
1.9 dT	66	01/96 → 08/03	D	F8Q784, F8Q786	
1.9 DTi	60	02/00 → 09/00	D	F9Q730	

**81574**
**350981574000**

**KW**

**RENAULT**
**Megane I, Coach, Cabrio, Scénic, Station Wagon**

1.9 dTi	59	02/01 → 08/03	D	F9Q744	
	72	03/97 → 02/01	D	F9Q730, F9Q731, F9Q734, F9Q736	
	72	04/97 → 09/99	D	F9Q730, F9Q734	
	72	03/97 → 02/01	D	F9Q731, F9Q734, F9Q736	
	72	03/99 → 02/01	D	F9Q731, F9Q736	
1.9 TDI	69	09/96 → 08/03	D	F8Q784	10-1996 →
	69	09/96 → 08/03	D	F8Q784	
2.0	84	04/97 → 08/03	B	F3R750, F3R798	
2.0 16V	102	01/02 → 08/03	B	F4R746	
	102	01/02 → 08/03	B	F4R746, F4R770	
	108	07/96 → 08/03	B	F7R710, F7R714	
2.0 16V IDE	103	11/99 → 08/03	B	F4R746, F5R740	
	103	11/99 → 08/03	B	F5R740	
2.0 i	80	03/99 → 08/03	B	F3R750, F3R751	
	80	03/99 → 08/03	B	F3R791, F3R796	
	80	03/99 → 08/03	B	F3R750, F3R751, F3R752, F3R791, F3R796, F3R797, F3R798	
	80	03/99 → 08/03	B	F3R791, F3R796	
	80	01/99 → 09/99	B	F3R796	
	84	01/96 → 08/03	B	F3R750, F3R751	
	84	09/96 → 08/03	B	F3R750, F3R751, F3R752, F3R791, F3R796, F3R797, F3R798	
	84	03/96 → 08/03	B	F3R750, F3R751, F3R798	

**81574** **350981574000**

**KW**

**RENAULT**
**Megane I, Coach, Cabrio, Scénic, Station Wagon**

2.0RXE 4x4 84 05/97 → 10/99 B F3R750

**Rapid**

40 09/93 → 04/95 D F8M736

1.6 D 40 03/86 → 08/98 D F8M720, F8M730, F8M736, F8M760

1.9 D 40 09/94 → 03/98 D F8Q640, F8Q682

1.9 D 47 09/91 → 03/98 D F8Q646, F8Q722, F8Q724, F8Q774, F8Q776

**Scénic I**

1.6 75 03/01 → 08/03 B K4M708, K4M709

1.8 16V 85 01/01 → 08/03 B F4P720, F4P722

1.8 4x4 85 07/00 → 04/01 B F4P722

1.9 D 47 09/99 → 03/01 D F8Q790

1.9 dCi 75 09/99 → 08/03 D F9Q732, F9Q733

1.9 dCi RX4 74 12/02 → 08/03 D F9Q732, F9Q748, F9Q796

75 11/00 → 08/03 D F9Q740

59 02/01 → 08/03 D F9Q744

1.9 dTi 72 09/99 → 08/03 D F9Q731, F9Q734, F9Q736

2.0 16V 103 09/99 → 08/03 B F4R740, F4R741, F4R744, F4R747 10-1996 →

2.0 16V 102 07/00 → 08/03 B F4R740, F4R741, F4R746

2.0 16V RX4 102 06/00 → 08/03 B F4R744, F4R746

**Sport Spider**

2.0 16V 110 03/95 → 10/99 B F7R710

**81574** **350981574000**

**KW**

**RENAULT**
**Super 5**

40 10/84 → 12/96 D F8M720

1.6 D 40 08/85 → 12/96 D F8M720, F8M730

1.7 54 10/86 → 03/95 B F3N716, F3N717

1.7 64 06/87 → 03/95 B F2N740, F2N742

1.7 i 69 10/86 → 08/91 B F3N702, F3N722

**Thalia I**

1.9 D 48 02/98 → 05/01 D F8Q630

2.0 124 09/01 → B F4R738

**Trafic I**

1.7 50 08/92 → 08/94 B F1N720 01-1986 →, → 12-1995

1.7 50 08/92 → 08/94 B F1N724 01-1986 →, → 12-1995

1.9 D 44 06/97 → 03/01 D F8Q606

**VOLVO**
**340 - 360**

1.6 Diesel 40 08/84 → 07/91 D D16

1.7 59 08/85 → 07/91 B B172K

**440**

1.6 61 09/88 → 12/96 B B16F

64 09/88 → 12/96 B B18KP

1.7 75 08/89 → 12/96 B B18FP

78 09/88 → 12/96 B B18EP

1.7 Turbo 88 08/88 → 07/96 B B18FT

90 01/91 → 12/96 B B18FT

1.8 66 08/91 → 12/96 B B18U

1.9 Turbo-Diesel 66 07/94 → 12/96 D D19T

2.0 80 08/93 → 07/96 B B20F

81 08/92 → 07/95 B B20F

**460**

1.6 61 07/92 → 07/96 B B16F

64 09/88 → 07/96 B B18KP

1.7 66 09/90 → 07/96 B B18KP

75 08/89 → 07/92 B B18EP

80 08/89 → 07/92 B B18E

1.7 Turbo 88 08/89 → 07/96 B B18FT

90 01/91 → 07/96 B B18FT

1.8 66 08/91 → 07/96 B B18U

**81574**
**350981574000**

**KW**

**VOLVO**
**460**

1.9 Turbo-Diesel	66	07/94 → 07/96	D	D19T	
2.0	80	08/93 → 07/96	B	B20F	
	81	08/92 → 07/95	B	B20F	

**480**

1.7	75	08/89 → 07/96	B	B18EP	
1.7 Turbo	88	08/87 → 07/96	B	B18FT	
	90	01/91 → 07/96	B	B18FT	
2.0	81	08/92 → 09/95	B	B20F	

**S 40 I**

1.9 DI	70	03/99 → 07/00	D	D4192T2	
1.9 TD	66	07/95 → 08/99	D	D4192T	01-1997 →

**V 40 I**

1.9 DI	70	03/99 → 07/00	D	D4192T2	
1.9 TD	66	07/95 → 08/99	D	D4192T	

**81576**
**350981576000**

**ALBERINO**

Diametro Alberino	Ø18
Posizione Attacco	56.5
Diametro Girante	Ø69
N° Alette Girante	9
Posizione Girante	17.3



**KW**

**RENAULT**
**Espace I**

2.0	74	01/88 → 12/90	B	J6R734	
	80	07/84 → 12/90	B	J6R234, J6R236	
2.0 i	87	01/89 → 12/90	B	J7R760	
2.0 i Quadra	87	03/88 → 12/92	B	J7R760	
2.1 TD	65	10/84 → 12/90	D	J8S240, J8S774, J8S776	
2.2	79	07/86 → 12/90	B	J7T770	
2.2 Quadra	79	01/88 → 12/90	B	J7T770	

**Master I**

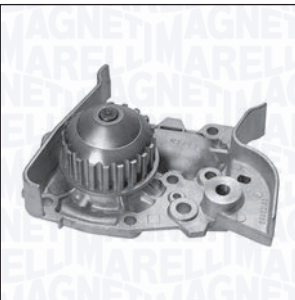
28-35 2.1 D	44	08/80 → 07/98	D	J8S330	
-------------	----	---------------	---	--------	--

**81578**
**350981578000**

**PULEGGIA**

Diametro Puleggia	Ø59.26
Numero Denti/Gole Puleggia	20
Altezza Puleggia	20.8
Posizione Attacco	46.1
Diametro Girante	Ø60
N° Alette Girante	6
Posizione Girante	19.5

**KW**

**DACIA**
**Solenza**

1.4	55	02/03 →	B	K7J710	
-----	----	---------	---	--------	--

**RENAULT**
**Clio II**

1.4	55	09/98 → 05/05	B	E7J634, E7J780, K7J700	
				M: E7J 634, M: E7J 780, M: E7J 635, M: E7J 634	

**Kangoo I, Van**

1.4	55	08/97 →	B	E7J634, E7J635, E7J780, K7J700, K7J701	M: E7J 634, M: E7J 780, M: E7J 635, M: E7J 634
				E7J634, E7J635, E7J780, K7J701	M: E7J 634, M: E7J 780, M: E7J 635, M: E7J 634

**Megane I, Coach, Cabrio, Scénic, Station Wagon**

1.4	55	09/96 → 08/03	B	E7J626, E7J764	
		03/99 → 08/03	B	E7J626	
1.4 e	55	01/96 → 08/03	B	E7J626, E7J764	
		01/96 → 03/99	B	E7J624	
1.4 i	55	01/97 → 09/99	B	E7J764	

**Rapid**

1.4	55	09/91 → 03/98	B	E7J720, E7J724, E7J726, E7J773	01-1996 →

**Thalia I**

1.4	55	08/00 →	B	K7J700	
-----	----	---------	---	--------	--

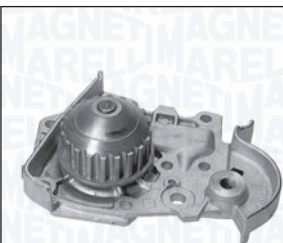
**81579**
**350981579000**

**PULEGGIA**

Diametro Puleggia	Ø59.26
Numero Denti/Gole Puleggia	20
Altezza Puleggia	20.8
Posizione Attacco	40.6
Diametro Girante	Ø60.5
N° Alette Girante	8
Posizione Girante	26

**KW**

**DACIA**
**Logan MCV**

1.4	55	02/07 →	B	K7J710
1.6	64	02/07 →	B	K7M710
1.6 Bifuel	64	11/08 →	BF	K7M710

**Logan, Station Wagon, Van**

1.4	55	03/09 →	B	K7J710
	55	09/04 →	B	K7J710
1.4 MPI LPG	55	02/06 →		K7J710, K7J714
1.6	64	03/09 →	B	K7M710
	64	09/04 →	B	K7M710
1.6 Bifuel	62	05/10 →	BF	K7M718

**Sandero I**

1.4	55	06/08 →	B	K7J710
1.4 MPI LPG	53	01/09 →		K7J714
1.6	64	06/08 →	B	K7M710

**RENAULT**
**Clio II**

1.6	66	09/98 → 05/05	B	K7M744, K7M745
-----	----	---------------	---	-------------------

**Kangoo I, Van**

1.4	55	08/97 →	B	E7J634, E7J635, E7J780, K7J700, K7J701	M: K7J 701, M: K7J 700
	55	08/97 →	B	E7J634, E7J635, E7J780, K7J701	M: K7J 701, M: K7J 700
1.6	66	09/99 → 06/01	B	K7M746	

**Kangoo II, Be Bop, Van**

1.6	64	02/08 →	B	K7M750
	64	02/08 →	B	K7M750

**Logan I, Station Wagon**

1.4	55	09/04 →	B	K7J710
1.6	64	09/04 →	B	K7M710

**81579**
**350981579000**

**KW**

**RENAULT**
**Logan I, Station Wagon, Express**

1.4	55	10/07 →	B	K7J710
1.6	64	04/07 →	B	K7M710

**Megane I, Coach, Cabrio, Scénic, Station Wagon**

1.6 e	66	10/96 → 03/99	B	K7M702, K7M703
	66	01/96 → 03/99	B	K7M702, K7M703, K7M790
1.6 i	55	01/96 → 03/99	B	K7M720

**Sandero I**

1.4	55	02/09 →	B	K7J710
1.6	62	11/10 →	B	K7M718
	64	02/09 →	B	K7M710
	75	12/07 →	B	K7M710
	76	12/07 →	B	K4M690

**Thalia I**

1.6	66	03/98 →	B	K7M746
-----	----	---------	---	--------

**81584**
**350981584000**

**FLANGIA**

Numero Fori Flangia	4
Dimensione Fori Flangia	M6×1
Posizione Attacco	91.5
Diametro Mozzo	M24×1.5 SX
Diametro Centraggio	Ø40
Diametro Girante	Ø59
N° Alette Girante	9
Posizione Girante	14.5

**KW**

**BMW**
**3 II (E30), Touring, Cabrio**

316	66	09/82 → 12/90	B	M10B18 (184VC), M10B18 (184VD)	→ 09-1987
	73	09/87 → 06/91	B	M40B16 (164E1)	→ 09-1988
316 i	75	07/88 → 06/91	B	M40B16 (164E1)	→ 09-1988

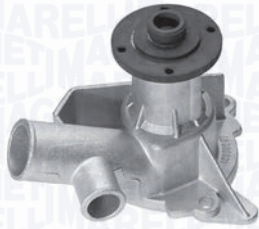
**81586**
**350981586000**

**FLANGIA**

Numero Fori Flangia	4
Dimensione Fori Flangia	M6×1
Posizione Attacco	106.5
Diametro Mozzo	M24×1.5 SX
Diametro Centraggio	Ø40
Diametro Girante	Ø70
N° Alette Girante	7
Posizione Girante	10.5

**KW**

**BMW**
**3 II (E30), Touring, Cabrio**

320 i	95	04/86 → 10/93	B	M20B20 (206KA)	→ 09-1987
	110	12/85 → 06/90	B	M20B20 (206KA)	→ 09-1987
	95	12/85 → 06/91	B	M20B20 (206KA), M20B20 (L-Jetronic)	→ 09-1987
325 i	125	12/86 → 06/91	B	M20B25 (256E1), M20B25 (256E2), M20B25 (256EX), M20B25 (256K1)	→ 09-1987
325 i X	125	12/86 → 08/91	B	M20B25 (256E1), M20B25 (256E2), M20B25 (256EX), M20B25 (256K1)	→ 09-1987
M3 2.3	143	06/88 → 06/91	B	S14B23 (234EA)	
	143	07/86 → 06/91	B	S14B23 (234EA), S14B23 (234S1), S14B23 (234S2)	
	158	06/89 → 06/91	B	S14B23 (234EA)	

**81587**
**350981587000**

**FLANGIA**

Numero Fori Flangia	4
Dimensione Fori Flangia	M6×1
Posizione Attacco	54.5
Diametro Mozzo	M24×1.5 SX
Diametro Centraggio	Ø38
Diametro Girante	Ø62
N° Alette Girante	7
Posizione Girante	64.3

**KW**

**BMW**
**3 II (E30), Touring, Cabrio**

316	66	09/82 → 12/90	B	M10B18 (184VC), M10B18 (184VD)	10-1987 →
	73	09/87 → 06/91	B	M40B16 (164E1)	10-1988 →
	73	09/91 → 06/94	B	M40B16 (164E1)	
316 i	75	07/88 → 06/91	B	M40B16 (164E1)	10-1988 →
	75	09/91 → 06/94	B	M40B16 (164E1)	
318 i	83	09/87 → 06/91	B	M40B18 (184E1)	
	83	04/89 → 06/94	B	M40B18 (184E1)	M: M40B16
	85	09/87 → 06/91	B	M40B18 (184E1)	
	103	06/88 → 02/92	B	M40B18C	
<b>5 III (E34), Touring</b>					
518 i	83	08/89 → 09/95	B	M40B18 (184E1)	04-1989 →, → 08-1991
	85	08/89 → 09/95	B	M43B18 (184E2)	→ 09-1991, DST:CND



**81588**
**350981588000**

**FLANGIA**

Numero Fori Flangia 4  
 Dimensione Fori Flangia M6×1  
 Posizione Attacco 47.7  
 Diametro Mozzo M24×1.5 SX  
 Diametro Centraggio Ø40  
 Diametro Girante Ø74  
 N° Alette Girante 7  
 Posizione Girante 60.55

**KW**

**BMW**
**3 III (E36), Touring, Cabrio, Coupé, Compact**

320 i	110	09/90 → 02/98	B	M50B20, M50B20 (206S1), M50B20 (206S2), M50B20TU, M52B20, M52B20 (206S3)	
	110	12/93 → 04/99	B	M50B20, M50B20 (206S2), M50B20TU, M52B20, M52B20 (206S3)	
	110	01/95 → 10/99	B	M50B20, M50B20TU, M52B20, M52B20 (206S3)	
323 i	125	03/95 → 04/99	B	M52B25 (256S3)	04-1995 →
	125	06/95 → 04/99	B	M52B25 (256S3)	
323 i 2.5	125	03/95 → 02/98	B	M52B25 (256S3)	04-1995 →
323 ti	125	08/97 → 08/00	B	M52B25 (256S3)	
325 i	141	09/90 → 09/95	B	M50B25 (256S1), M50B25 (256S2), M50B25TU	
	141	03/93 → 03/95	B	M50B25 (256S2), M50B25TU	
328 i	142	01/95 → 02/98	B	M52B28 (286S1), M52B28TU	

**81588**
**350981588000**

**KW**

**BMW**
**3 IV (E46), Touring, Cabrio, Coupé, Compact**

320 Ci	110	08/99 → 09/00	B	M52B20, M52B20 (206S4)	C: M
	120	01/06 → 12/07	B	M54B22 (226S1)	
	125	09/00 → 12/07	B	M54226S1, M54B22 (226S1)	
	125	09/00 → 07/06	B	M54B22, M54B22 (226S1)	
320 i	110	03/98 → 09/00	B	M52B20, M52B20 (206S4)	
	125	09/00 → 02/05	B	M54B22, M54B22 (226S1)	
323 Ci	125	04/00 → 09/00	B	M52B25 (256S4)	
323 i	125	03/98 → 09/00	B	M52B25 (256S4), M52B25TU	
325 Ci	141	09/00 → 07/06	B	M54256S5, M54B25 (256S5)	
	141	09/00 → 12/07	B	M54256S5, M54B25 (256S5)	
325 i	141	09/00 → 02/05	B	M54B25, M54B25 (256S5)	
325 ti	141	06/01 → 02/05	B	M54B25, M54B25 (256S5)	
325 xi	141	09/00 → 02/05	B	M54256S5, M54B25 (256S5)	
328 Ci	142	04/99 → 06/00	B	M52B28 (286S2)	
328 i	142	02/98 → 06/00	B	M52B28 (286S2)	
330 Ci	170	06/00 → 12/07	B	M54306S3, M54B30 (306S3)	

**81588**
**350981588000**

**KW**

**BMW**
**3 IV (E46), Touring, Cabrio, Coupé, Compact**

330 Ci	170	06/00 → 07/06	B	M54B30 (306S3)
330 i	170	06/00 → 02/05	B	M54B30, M54B30 (306S3)
330 xi	170	06/00 → 02/05	B	M54B30 (306S3)

**5 III (E34), Touring**

520 i	110	11/91 → 01/97	B	M50B20, M50B20 (206S1), M50B20 (206S2), M50B20TU
520 i 24V	110	09/89 → 09/95	B	M50B20, M50B20 (206S1), M50B20 (206S2), M50B20TU
525 i	141	11/91 → 01/97	B	M50B25 (256S1), M50B25 (256S2)
525 i 24V	141	09/89 → 09/95	B	M50B25 (256S2), M50B25TU, M52B25 (Vanos)
525 ix	141	02/92 → 01/97	B	M50B25 (256S1), M50B25 (256S2)
525 ix 24V	141	10/91 → 09/95	B	M50B25 (256S1), M50B25 (256S2)

**5 IV (E39), Touring**

520 i	100	04/99 → 06/03	B	M52B20 (206S3)
	110	01/96 → 09/00	B	M52B (206S4), M52B20, M52B20 (206S3)
	125	09/00 → 06/03	B	M54B22 (226S1)
	125	09/00 → 05/04	B	M54B22, M54B22 (226S1)

**81588**
**350981588000**

**KW**

**BMW**
**5 IV (E39), Touring**

523 i	125	11/95 → 09/00	B	M52B25 (256S3), M52B25TU
525 i	141	09/00 → 05/04	B	M54256S5, M54B25, M54B25 (256S5)
	141	09/00 → 06/03	B	M54B25, M54B25 (256S5)
528 i	142	11/95 → 09/00	B	M52B28 (286S1), M52B28 (286S2)
530 i	170	09/00 → 05/04	B	M54B30 (306S3)
530 i	170	09/00 → 06/03	B	M54B30, M54B30 (306S3)

**5 V (E60), Touring (E61)**

520 i	125	07/03 → 03/10	B	M54B22, M54B22 (226S1)
525 i	141	09/03 → 03/10	B	M54256S5, M54B25, M54B25 (256S5)
	141	06/04 → 12/10	B	M54B25, M54B25 (256S5)
530 i	170	07/03 → 03/10	B	M54306S3, M54B30, M54B30 (306S3)

**7 III (E38)**

728 i,iL	142	08/95 → 11/01	B	M52B28 (286S1), M52B28 (286S2)
728i X	142	11/95 → 09/01	B	M52B28 (286S1), M52B28TU

**81588 350981588000**

**BMW**
**7 IV (E65, E66)**

730 i, Li	170	03/03 → 07/08	B	M54B30, M54B30 (306S3)
-----------	-----	---------------	---	------------------------------

**X3 I (E83)**

2.5 i	141	01/04 → 08/06	B	M54256S5, M54B25, M54B25 (256S5)
-------	-----	---------------	---	---

3.0 i xDrive	170	01/04 → 08/06	B	M54306S3, M54B30, M54B30 (306S3)
--------------	-----	---------------	---	---

**X5 I (E53)**

3.0 i	163	05/00 → 12/06	B	M54B30 (306S3)
-------	-----	---------------	---	-------------------

	170	05/00 → 12/06	B	M54306S3, M54B30, M54B30 (306S3)
--	-----	---------------	---	---

**Z3 (E36), Coupé**

2.0	110	04/99 → 01/03	B	M52B20, M52B20 (206S4)	04-1999 →
-----	-----	---------------	---	------------------------------	-----------

2.2	125	08/00 → 01/03	B	M54226S1, M54B22, M54B22 (226S1)
-----	-----	---------------	---	---

2.8	141	07/97 → 06/00	B	M52B28 (286S1)
-----	-----	---------------	---	-------------------

2.8	141	04/97 → 06/00	B	M52B28 (286S1), M52B28TU
-----	-----	---------------	---	--------------------------------

3.0	170	06/00 → 06/03	B	M54306S3, M54B30 (306S3)
-----	-----	---------------	---	--------------------------------

	170	06/00 → 01/03	B	M54B30, M54B30 (306S3)
--	-----	---------------	---	------------------------------

**Z4 I (E85), Coupé (E86)**

2.2 i	125	10/03 → 10/05	B	M54B22, M54B22 (226S1)
-------	-----	---------------	---	------------------------------

**81588 350981588000**

**BMW**
**Z4 I (E85), Coupé (E86)**

2.5 i	141	02/03 → 12/05	B	M54B25, M54B25 (256S5)
-------	-----	---------------	---	------------------------------

3.0 i	170	02/03 → 10/05	B	M54B30, M54B30 (306S3)
-------	-----	---------------	---	------------------------------

**81589 350981589000**

	<b>FLANGIA</b>
	Numero Fori Flangia 4 Dimensione Fori Flangia M6×1 Posizione Attacco 56 Diametro Mozzo M24×1.5 SX Diametro Centraggio Ø38 Diametro Girante Ø62 N° Alette Girante 7 Posizione Girante 59.5

**BMW**
**3 III (E36), Touring, Cabrio, Coupé, Compact**

316 i	73	09/90 → 09/93	B	M40B16 (164E1)	M: M40B16
-------	----	---------------	---	-------------------	-----------

	75	09/90 → 09/93	B	M43B16, M43B16 (164E2)
--	----	---------------	---	------------------------------

318 i	83	12/90 → 10/93	B	M40B18 (184E1)	M: M40B16
-------	----	---------------	---	-------------------	-----------

**5 III (E34), Touring**

518 g	85	11/95 → 06/96	BF	M43B18 (184E2)
-------	----	---------------	----	-------------------

518 i	83	03/93 → 09/94	B	M43B18 (184E2)
-------	----	---------------	---	-------------------

	85	08/89 → 09/95	B	M43B18 (184E2)	10-1991 →, DST:CND
--	----	---------------	---	-------------------	-----------------------

	85	09/94 → 01/97	B	M43B18 (184E2)	→ 12-1995
--	----	---------------	---	-------------------	-----------

81590

350981590000



**FLANGIA**

Numero Fori Flangia 4  
 Dimensione Fori Flangia M6×1  
 Posizione Attacco 56.5  
 Diametro Mozzo M24×1.5 SX  
 Diametro Centraggio Ø38  
 Diametro Girante Ø62  
 N° Alette Girante 7  
 Posizione Girante 59.5



**BMW**

**3 II (E30), Touring, Cabrio**

318 is	100	09/89 → 08/91	B	M42B18 (184S1)	
--------	-----	---------------	---	----------------	--

**3 III (E36), Touring, Cabrio, Coupé, Compact**

316 g	75	03/94 → 08/00	BF	M43B16 (164E2)	
-------	----	---------------	----	----------------	--

316 i	73	09/90 → 09/93	B	M40B16 (164E1)	M: M43B16 / C / K
	75	07/93 → 02/98	B	M43B16 (164E2)	

316 i	75	03/94 → 08/00	B	M43B16 (164E2)	M: M43B16 / C / K
	77	12/98 → 08/00	B	M43B19 (194E1)	

318 i	85	10/93 → 02/98	B	M43B18 (184E2)	M: M40B16
	85	01/94 → 04/99	B	M43B18 (184E2)	M: M43B19C

318 i	85	07/95 → 10/99	B	M43B18 (184E2)	M: M43B18 / C
	103	03/93 → 02/98	B	M42B18 (184S1)	

318 is	103	09/95 → 02/98	B	M44B19 (194S1)	
	103	11/94 → 08/95	B	M42B18 (184S1)	

318 ti	103	07/95 → 08/00	B	M44B19 (194S1)	M: M44B19 / C
--------	-----	---------------	---	----------------	---------------

316 Ci	77	04/00 → 07/06	B	M43B16 (164E3)	→ 06-2001
--------	----	---------------	---	----------------	-----------

316 i	77	04/00 → 02/05	B	M43B16, M43B16 (164E3)	
-------	----	---------------	---	------------------------	--

316 i	77	09/98 → 02/05	B	M43B19 (194E1), M43B19TU	
-------	----	---------------	---	--------------------------	--

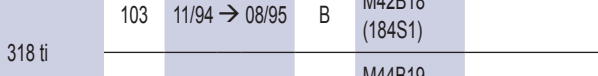

**VOLVO**

**740, Station Wagon**

2.3	84	08/84 → 07/90	B	B230F, B23A	
-----	----	---------------	---	-------------	--

81590

350981590000



**BMW**

**3 IV (E46), Touring, Cabrio, Coupé, Compact**

318 Ci	87	11/99 → 09/01	B	M43B19 (194E1)	
--------	----	---------------	---	----------------	--

318 i	85	10/99 → 09/01	B	M43B19 (194E1)	
	87	02/98 → 09/01	B	M43B19 (194E1), M43B19TU	

318 i	85	10/99 → 09/01	B	M43B19 (194E1)	
	87	02/98 → 09/01	B	M43B19 (194E1), M43B19TU	

**5 III (E34), Touring**

518 i	85	08/89 → 09/95	B	M43B18 (184E2)	01-1993 →, DST:CTN
-------	----	---------------	---	----------------	--------------------

**Z3 (E36), Coupé**

1.8	85	10/95 → 10/98	B	M43B18 (184E2)	M: M42B18
-----	----	---------------	---	----------------	-----------

1.9	85	01/99 → 01/03	B	M43194E1, M43B19 (194E1)	M: M44B19 C
	87	07/98 → 01/03	B	M43194E1, M43B19 (194E1), M43B19TU	

1.9	87	07/98 → 01/03	B	M43194E1, M43B19 (194E1), M43B19TU	
	103	10/95 → 03/99	B	M44B19 (194S1)	M: M44B19 C

1.9	87	07/98 → 01/03	B	M43194E1, M43B19 (194E1), M43B19TU	
	103	10/95 → 03/99	B	M44B19 (194S1)	M: M44B19 C

1.9	87	07/98 → 01/03	B	M43194E1, M43B19 (194E1), M43B19TU	
	103	10/95 → 03/99	B	M44B19 (194S1)	M: M44B19 C

1.9	87	07/98 → 01/03	B	M43194E1, M43B19 (194E1), M43B19TU	
	103	10/95 → 03/99	B	M44B19 (194S1)	M: M44B19 C

81592

350981592000



**FLANGIA**

Numero Fori Flangia 4  
 Dimensione Fori Flangia M6×1  
 Posizione Attacco 131.5  
 Diametro Girante Ø70  
 N° Alette Girante 6  
 Posizione Girante -0.5



**VOLVO**

**740, Station Wagon**

2.3	84	08/84 → 07/90	B	B230F, B23A	
-----	----	---------------	---	-------------	--

**81593**
**350981593000**

	<b>PULEGGIA</b>	
	Diametro Puleggia	Ø59.17
	Numero Denti/Gole Puleggia	20
	Altezza Puleggia	27.5
	Posizione Attacco	29
	Diametro Girante	Ø72
	N° Alette Girante	7
Posizione Girante	33	

**KW**

**AUDI**
**100 III, Avant**

2.0 D	51	03/83 → 11/90	D	CN	→ 05-1990, → T: F-L-100.000
2.0 D Turbo	74	03/88 → 11/90	D	NC	→ 05-1990, → T: F-L-100.000
2.0 TD	74	03/88 → 11/90	D	NC	→ 05-1990, → T: F-L-100.000
2.4 D	60	08/89 → 07/91	D	3D	→ 05-1990, → T: F-L-100.000

**VOLKSWAGEN**
**LT I 28-35, 40-55**

2.4 D	51	08/89 → 06/96	D	1S, ACT	
	55	01/79 → 07/92	D	CP, DW	
2.4 TD	68	08/89 → 08/92	D	1G	
	75	02/86 → 08/92	D	DV	
2.4 TD 4WD	75	08/78 → 07/92	D	DV	

**VOLVO**
**240, Station Wagon**

2.4 Diesel	58	08/87 → 08/93	D	D24	01-1979 →, → 12-1993
	58	08/88 → 08/93	D	D24	

**740, Station Wagon**

2.4 Diesel	60	08/84 → 07/92	D	D24	
2.4 TD	80	08/85 → 12/90	D	D24T	
	83	08/84 → 07/90	D	D24T	
2.4 Turbo-Diesel	80	09/85 → 07/92	D	D24T	

**760, Station Wagon**

2.4 D	60	01/82 → 07/92	D	D24	
2.4 TD Interc.	85	08/87 → 07/92	D	D24TIC	
2.4 Turbo Diesel	80	04/87 → 07/92	D	D24T	

**81593**
**350981593000**

	<b>KW</b>				
<b>VOLVO</b>					
<b>940 I, Station Wagon</b>					
2.4 D	60	08/90 → 12/94	D	D24	
2.4 TD Intercooler	90	08/90 → 12/94	D	D24TIC	→ 06-1992, → T: 30.003
2.4 Turbo Diesel	80	08/90 → 12/94	D	D24T	
2.4 TD Interc.	85	09/91 → 07/94	D	D24TIC	→ 06-1992, → T: 30.003

**81594**
**350981594000**

	<b>FLANGIA</b>	
	Numero Fori Flangia	4
	Dimensione Fori Flangia	M6×1
	Posizione Attacco	131
	Diametro Girante	Ø70
	N° Alette Girante	6
Posizione Girante	-0.5	

**KW**

**VOLVO**
**240, Station Wagon**

2.0	86	08/83 → 07/93	B	B200E	
2.3 Cat.	100	08/91 → 07/92	B	B230F	
2.3 i Cat.	85	08/86 → 07/93	B	B230F	09-1984 →, → 12-1993
	85	08/86 → 07/93	B	B230F	

**740, Station Wagon**

2.0	76	09/88 → 08/90	B	B200K	
	82	09/90 → 08/92	B	B200F	
	89	08/85 → 07/92	B	B200E, B200G	
	89	08/85 → 07/92	B	B200G	
2.0 GLE	103	09/87 → 08/90	B	B204E	
2.0 Turbo	114	09/90 → 08/91	B	B200FT	
	115	09/87 → 08/90	B	B200ET	
2.3	84	09/85 → 07/90	B	B230K	
	85	08/87 → 07/92	B	B230F	
	100	08/88 → 07/90	B	B230FB	
	111	08/88 → 08/92	B	B234F	
	114	08/88 → 07/91	B	B234F	

**81594**
**350981594000**

**KW**

**VOLVO**
**740, Station Wagon**

2.3 Turbo	121	08/89 → 07/90	B	B230FT
	121	08/89 → 07/90	B	B230FT, B230GT
	125	09/89 → 08/91	B	B230FT, B230GT
	140	08/89 → 07/90	B	B230FT

**760, Station Wagon**

2.3	121	01/88 → 07/92	B	B230FT
2.3 Turbo	115	09/87 → 08/90	B	B230FT
	134	08/84 → 08/90	B	B230ET

**940 I, Station Wagon**

2.0	82	01/92 → 07/94	B	B200F
	89	09/90 → 09/93	B	B200E, B200G
	89	09/90 → 09/93	B	B200G
	102	09/90 → 09/93	B	B204FT
2.0 Turbo	114	08/90 → 12/94	B	B200FT
2.3	85	08/92 → 07/94	B	B230FD
	96	08/90 → 12/94	B	B230FB
	96	08/90 → 12/94	B	B230FB, B230G
	114	08/90 → 07/91	B	B234F
	114	08/90 → 07/91	B	B234F, B234G
2.3 Turbo	121	08/90 → 07/94	B	B230FT
	140	08/91 → 07/93	B	B230FT+

**940 II, Station Wagon**

2.0	89	11/94 → 12/95	B	B200G
	102	10/94 → 05/97	B	B204FT
2.0 Turbo	114	04/96 → 10/98	B	B200FT
2.3	85	08/94 → 07/95	B	B230FD
	96	08/94 → 10/98	B	B230FB
2.3 ti	99	01/95 → 10/98	B	B230FK
2.3 Turbo	121	08/94 → 10/98	B	B230FT
	126	08/95 → 10/98	B	B230FT

**960 I, Station Wagon**

2.0	103	09/90 → 08/93	B	B204E
	140	08/90 → 09/93	B	B204FT
2.3 Turbo	121	09/90 → 08/93	B	B230FT

**81596**
**350981596000**

**PULEGGIA**

Diametro Puleggia	Ø144
Numero Denti/Gole Puleggia	1
Posizione Attacco	29.5
Diametro Girante	Ø67
N° Alette Girante	8
Posizione Girante	18

**KW**

**RENAULT**
**Clio I**

1.2	40	06/94 → 02/98	B	C3G720	(-)COP
	40	01/96 → 12/96	B	C3G720	(-)COP

**Rapid**

1.2	40	09/91 → 03/98	B	C3G710, C3G712	(-)COP
-----	----	---------------	---	-------------------	--------

**Twingo I**

1.2	40	03/93 → 10/96	B	C3G700, C3G702	(-)COP, (-)AC
-----	----	---------------	---	-------------------	---------------

**81597**
**350981597000**

**FLANGIA**

Numero Fori Flangia	4
Dimensione Fori Flangia	M6×1
Posizione Attacco	55.85
Diametro Mozzo	M24×1.5 SX
Diametro Centraggio	Ø40
Diametro Girante	Ø74
N° Alette Girante	7
Posizione Girante	60.55

**KW**

**BMW**
**3 III (E36), Touring, Cabrio, Coupé, Compact**

318 tds	66	01/95 → 02/98	D	M41D17 (174T1)
325 td	85	09/91 → 02/98	D	M51D25 (256T1)
325 tds	105	05/93 → 02/98	D	M51D25 (256T1)

**5 III (E34), Touring**

525 td	85	04/93 → 09/95	D	M51D25 (256T1)
525 tds	105	09/91 → 09/95	D	M51D25 (256T1)

**81597 350981597000**

**BMW**
**5 IV (E39), Touring**

525 td	85	01/97 → 06/03	D	M51D25 (256T1)	
525 tds	105	01/96 → 06/03	D	M51D25 (256T1)	

**7 III (E38)**

725 tds	105	04/96 → 11/01	D	M51D25 (256T1)	
---------	-----	---------------	---	-------------------	--

**LAND ROVER**
**Range Rover II**

2.5 D 4x4	100	07/94 → 03/02	D	256T (BMW)	
-----------	-----	---------------	---	------------	--

**OPEL**
**Omega B, Station Wagon**

2.5 D	96	05/94 → 05/99	D	X25TD	
2.5 TD	96	04/94 → 07/03	D	25DT, X25DT, X25TD	

**81598 350981598000**



**FLANGIA**

Numero Fori Flangia 4

Dimensione Fori Flangia M8x1.25

Posizione Attacco 93

Diametro Girante Ø55.5

N° Alette Girante 6

Posizione Girante 12.5

**FORD**
**Fiesta IV, Van**

1.25 i 16V	55	08/95 → 01/02	B	DHA, DHB, DHC, DHD, DHE, DHF, DHG	
1.4 i	66	04/96 → 10/99	B	FHA	
1.4 i 16V	66	04/96 → 01/02	B	FHA, FHE	
1.6 16V Sport	76	02/00 → 01/02	B	L1T, L1V	

**Fiesta V, Van**

1.25 16V	51	03/03 → 06/08	B	M7JA, M7JB	→ 04-2005
	55	05/02 → 06/08	B	FUJA, FUJB	→ 04-2005
1.4 16V	59	11/01 → 06/08	B	FXJA, FXJB	→ 04-2005
1.6 16V	74	11/01 → 06/08	B	FYJA, FYJB	→ 04-2005

**81598 350981598000**

**FORD**
**Focus C-Max**

1.6	74	10/03 → 03/07	B	HWDA, HWDB	→ 04-2005
1.6 Ti	85	08/04 → 03/07	B	HXDA, SIDA	→ 04-2005

**Focus I, Station Wagon**

1.4 16V	55	10/98 → 11/04	B	FXDA, FXDB, FXDC, FXDD	10-1998 →
	55	02/99 → 11/04	B	FXDA, FXDB, FXDC, FXDD	
1.6 16V	74	10/98 → 11/04	B	FYDA, FYDB, FYDC, FYDD, FYDH	10-1998 →
	74	02/99 → 11/04	B	FYDA, FYDB, FYDC, FYDD, FYDH	
1.6 16V Flexifuel	75	01/02 → 11/04		FYDH	

**Focus II, Station Wagon, Cabrio**

1.4	59	07/04 → 09/12	B	ASDA, ASDB	→ 04-2005
1.6	74	07/04 → 09/12	B	HWDA, HWDB, SHDA, SHDB, SHDC	→ 04-2005
	85	07/04 → 09/12	B	HXDA, HXDB	→ 04-2005
1.6 Ti	85	07/04 → 09/12	B	HXDA, HXDB, SIDA	→ 04-2005

**Fusion**

1.25	55	08/04 → 12/12	B	FUJA, FUJB	→ 04-2005
1.4	59	08/02 → 12/12	B	FXJA, FXJB, FXJC	→ 04-2005
1.4 LPG	59	01/10 → 12/12		UTJA	
1.6	74	08/02 → 11/08	B	FYJA, FYJB, FYJC	→ 04-2005

**81598**
**350981598000**

**FORD**
**Puma**

1.4 16V	66	11/97 → 10/00	B	FHD, FHF
1.6 16V	76	08/00 → 06/02	B	L1W
1.7 16V	92	03/97 → 06/02	B	MHA, MHB
ST 160	118	06/99 → 06/02	B	

**MAZDA**
**2 I**

1.25	55	04/03 →	B	FUJA
1.3 L	67	04/03 → 06/07	B	ZJ04
1.4	59	02/03 →	B	FXJA
1.6	74	02/03 →	B	FYJA

**121**

1.25	55	03/96 → 04/03	B	DHF, DHG
1.3 i 16V	53	11/90 → 03/96	B	B3 (16V)

**2 I**

1.2	55	02/03 →	B	FUJA
-----	----	---------	---	------

**VOLVO**
**C 30**

1.6	74	10/06 → 12/12	B	B4164S3
-----	----	---------------	---	---------

**V 40 II**

T2 GTDi	88	03/13 →	B	B4164T4
T3 GTDi	110	03/12 →	B	B4164T3
T4 GTDi	132	03/12 →	B	B4164T

**V 50**

1.6	74	01/05 →	B	B4164S3
-----	----	---------	---	---------

**81602**
**350981602000**

**FLANGIA**

Numero Fori Flangia	4
Dimensione Fori Flangia	M8x1.25
Posizione Attacco	95.5
Diametro Mozzo	M24x1.5 SX
Diametro Centraggio	Ø32.2
Diametro Girante	Ø71
N° Alette Girante	7
Posizione Girante	12.5

**FORD**
**P 100 II**

2.0	57	10/87 → 12/92	B	NAE
-----	----	---------------	---	-----

**Scorpio I, Station Wagon**

1.8	66	04/85 → 02/92	B	REC	10-1984 →, → 12-1990, VA
2.0 i	74	10/85 → 12/90	B	NRC	
	85	04/85 → 02/92	B	NRA, NRI	→ 12-1988

**81602**
**350981602000**

**FORD**
**Sierra II, Station Wagon**

1.6	53	01/88 → 02/93	B	LSF	(+)SS
	53	01/88 → 02/93	B	LSF	(+)SS, VA
	55	01/87 → 02/93	B	LSE	(+)SS
1.6 i	59	10/89 → 02/93	B	L6B	(+)SS
	59	10/89 → 02/93	B	L6B	(+)SS
2.0	77	01/87 → 02/93	B	N8C, NES	(+)SS
	80	07/89 → 12/92	B	N8A	(+)SS
2.0 16V Cosworth 4x4	162	01/90 → 02/93	B	N5D	
2.0 16V Cosworth 4x4 Cat.	162	01/90 → 02/93	B	N5C	
2.0 4x4	88	01/90 → 02/93	B	N9C	(+)SS
2.0 i	74	01/87 → 02/93	B	NE5, NEJ	(+)SS
	85	01/87 → 02/93	B	N4A, N4I	(+)SS
	80	06/89 → 02/93	B	N8A	(+)SS
2.0 i Cat.	74	01/87 → 02/93	B	N4B	(+)SS
2.0 RS Cosworth	150	11/87 → 01/90	B	N5B	

**Transit IV**

1.6	46	09/85 → 09/92	B	LAT	VA
2.0	57	12/85 → 09/92	B	N6T	VA
	57	11/85 → 09/92	B	NAT, NAV	VA

**Transit Tourneo I**

2.0	84	11/94 → 12/00	B	NSH	
-----	----	---------------	---	-----	--

**Transit V**

2.0	66	09/91 → 09/94	B	NBA	
	72	09/91 → 08/94	B	NCA	
2.0 i	72	09/91 → 07/94	B	NCA	

**Transit VI**

2.0	84	09/95 → 03/00	B	NSF, NSG	
2.0 CNG	84	06/94 → 03/00		NSH	



**81605**
**350981605000**

**KW**

**OPEL**
**Astra F, Station Wagon, Cabrio, Van**

1.7 D	42	03/92 → 09/92	D	17D	
	44	07/92 → 09/98	D	17DR	→ 12-1992, → M: 14.363.651

**Kadett E, Station Wagon, Coupé, Cabrio, Van**

1.7 D	42	02/89 → 08/91	D	17D	09-1989 →, → 05-1992
	42	02/89 → 08/91	D	17D	
	44	07/92 → 07/94	D	17DR	

**Vectra A**

1.7 D	42	10/88 → 09/92	D	17D	→ M: 14.333.449
	44	07/92 → 11/95	D	17DR	→ 12-1992, → M: 14.333.449

**81606**
**350981606000**

**KW**

**DAEWOO**
**Espero**

1.8	66	02/95 → 09/99	B	C18LE	→ 10-1995
	70	02/95 → 06/99	B	C18LE	→ 10-1995
2.0	74	10/91 → 09/93	B	C20LZ	
	77	02/95 → 06/99	B	C20LE	→ 10-1995
	81	10/93 → 09/94	B	C20LE	

**81606**
**350981606000**

**KW**

**OPEL**
**Astra F, Station Wagon, Cabrio, Van**

1.8 i	66	03/92 → 09/98	B	C18NZ	→ 10-1992, → M: 14.254.438
2.0 i	85	03/92 → 09/98	B	C20NE	→ 10-1992, → M: 14.608.700
	85	03/93 → 10/94	B	C20NE	→ M: 14.608.700

**Calibra**

2.0 i	85	06/90 → 07/97	B	C20NE	→ 12-1992, → M: 14.608.700
2.0 i 4x4	85	06/90 → 07/97	B	C20NE	→ 12-1992, → M: 14.608.700

**Frontera A**

2.0 i	85	03/92 → 10/98	B	C20NE, X20SE	M: C20NE
-------	----	---------------	---	-----------------	----------

**Kadett E, Station Wagon, Coupé, Cabrio, Van**

1.8	84	09/87 → 08/90	B	18E	09-1988 →, M →: 14.237.770
-----	----	---------------	---	-----	-------------------------------

1.8 S	62	09/87 → 08/91	B	E18NV	
	62	09/87 → 08/91	B	E18NV, S18NV	

1.8 S	62	09/87 → 08/91	B	E18NV	
2.0 GSI	85	09/86 → 08/91	B	20NE	
	95	09/86 → 08/91	B	20SEH	
2.0 GSI Cat.	85	09/86 → 08/91	B	C20NE	
2.0 i	85	10/86 → 02/93	B	20NE	
	85	03/87 → 08/91	B	20NE, 20SE	
2.0 i Cat.	85	03/87 → 08/91	B	C20NE	

**Omega A, Station Wagon**

1.8	65	09/87 → 03/94	B	E18NVR	
	85	09/86 → 03/94	B	18SEH	
1.8 S	66	09/86 → 03/94	B	18SV	
2.0	90	09/86 → 03/94	B	20SE	→ 12-1989, → M: 14.608.700
2.0 i	85	09/86 → 03/94	B	C20NE	→ 12-1989, → M: 14.608.700

**Vectra A**

1.8 i	66	09/88 → 10/90	B	18SV	→ T: N5.999.999
1.8 i Cat.	66	03/90 → 11/95	B	C18NZ	→ 12-1992, → T: N5.999.999
1.8 S	66	09/89 → 10/90	B	18SV	→ T: N5.999.999
2.0 i	85	09/88 → 10/90	B	20NE	→ T: N5.999.999

**81606**
**350981606000**

**OPEL**
**Vectra A**

2.0 i	95	09/88 → 09/92	B	20SEH	08-1988 →, → 12-1992, → T: N5.999.999
2.0 i 4x4	85	01/89 → 10/90	B	20NE	→ T: N5.999.999
	95	01/89 → 09/92	B	20SEH	08-1988 →, → 12-1992, → T: N5.999.999
2.0 i 4x4 Cat.	85	01/89 → 11/95	B	C20NE	08-1988 →, → 12-1992, → T: N5.999.999
2.0 i Cat.	85	09/88 → 11/95	B	C20NE	→ 12-1992, → T: N5.999.999
2.0 i GT	95	09/88 → 11/95	B	20SEH	→ 12-1992, → T: N5.999.999

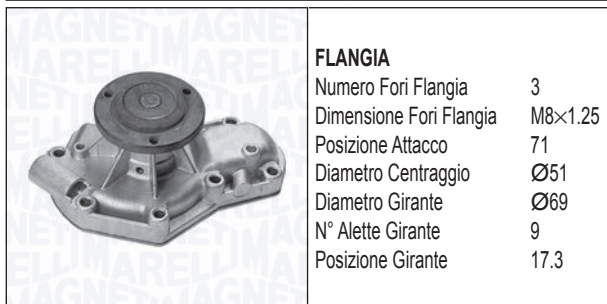
**81608**
**350981608000**

**FLANGIA**

Numero Fori Flangia	3
Dimensione Fori Flangia	M8x1.25
Posizione Attacco	71
Diametro Centraggio	Ø51
Diametro Girante	Ø69
N° Alette Girante	9
Posizione Girante	17.3

**RENAULT**
**21, Station Wagon**

2.0	78	05/91 → 10/93	B	J6R758	→ M: F.197.763
	75	03/86 → 10/93	B	J6R758, J6R759, J6R792, J6R793	→ M: F.197.763
	88	09/89 → 12/93	B	J7R746, J7R747	→ M: F.197.763
	99	02/90 → 10/92	B	J7R740	→ M: F.197.763
2.0 4x4	88	03/89 → 12/93	B	J7R746, J7R747	→ M: F.197.763
	99	09/90 → 10/92	B	J7R740	→ M: F.197.763
2.1 D	49	06/86 → 08/94	D	J8S704	
	48	10/86 → 09/90	D	J8S704	
	51	04/92 → 06/94	D	J8S784	
	53	09/89 → 12/92	D	J8S600, J8S740	

**81608**
**350981608000**

**RENAULT**
**21, Station Wagon**

2.1 D 4x4	48	10/88 → 05/92	D	J8S704	
2.1 Turbo-D	65	09/89 → 06/94	D	J8S714,	
				J8S786, J8S788	
2.2	79	09/89 → 06/94	B	J7T754, J7T755	→ M: F241.442
2.2 4x4	79	07/90 → 06/94	B	J7T754, J7T755	→ M: F241.442

**Trafic I**

2.1 D	47	06/94 → 10/97	D	J8S620, J8S758	09-1994 →
-------	----	---------------	---	-------------------	-----------

**81611**
**350981611000**

**PULEGGIA**

Diametro Puleggia	Ø59
Numero Denti/Gole Puleggia	20
Altezza Puleggia	28
Posizione Attacco	53.1
Diametro Girante	Ø56
N° Alette Girante	7
Posizione Girante	12

**HONDA**
**Civic IV, Hatchback**

1.3 16 V	55	09/89 → 09/91	B	D13B2	
----------	----	---------------	---	-------	--

**81613**
**350981613000**

**PULEGGIA**

Diametro Puleggia	Ø56.3
Numero Denti/Gole Puleggia	19
Altezza Puleggia	26.5
Posizione Attacco	53
Diametro Girante	Ø62
N° Alette Girante	7
Posizione Girante	15

**HONDA**
**Civic II Shuttle**

1.4 i 16V	66	01/88 → 12/92	B	D14A1	
1.5 i 16V	69	01/88 → 11/91	B	D15B2	
1.6 4x4	85	01/88 → 12/92	B	D16A, D16A7	

**81613**
**350981613000**

**KW**

**HONDA**
**Civic II Shuttle**

1.6 i 16V 4WD	81	01/88 → 02/95	B	D16A6	
------------------	----	---------------	---	-------	--

**Civic IV, Hatchback**

1.5 i 16V	66	10/88 → 09/91	B	D15B2	
	69	10/88 → 09/91	B	D15B2	

1.6 4x4	110	01/88 → 12/91	B	D16W4	
---------	-----	---------------	---	-------	--

1.6 i 16V	96	09/87 → 09/91	B	D16A7	
-----------	----	---------------	---	-------	--

1.6 i 16V	96	09/87 → 09/91	B	D16A7, D16A9	
	80	10/87 → 09/91	B	D16A6	

1.6 i 16V	81	10/87 → 09/91	B	D16Z2	
-----------	----	---------------	---	-------	--

1.6 i 16V 4x4	80	10/89 → 09/91	B	D16A6	
---------------	----	---------------	---	-------	--

1.6 i 16V Vtec	110	10/89 → 09/91	B	B16A1	
-------------------	-----	---------------	---	-------	--

**Civic V, Hatchback, Coupé**

1.3 16V	55	10/91 → 11/95	B	D13B2	
---------	----	---------------	---	-------	--

1.5	61	01/92 → 12/92	B	D15B2	
	66	10/93 → 12/95	B	D15B2	

1.5	74	10/93 → 12/95	B	D15B2, D15Z1	
-----	----	---------------	---	-----------------	--

1.5 i 16V	66	10/91 → 11/95	B	D15B2, D15Z2	
-----------	----	---------------	---	-----------------	--

1.5 i 16V	69	10/91 → 11/95	B	D15B2, D15Z1	
-----------	----	---------------	---	-----------------	--

1.5 i LSi	74	08/93 → 11/95	B	D15B7	
-----------	----	---------------	---	-------	--

1.6 16V Vtec	92	10/91 → 11/95	B	D16Z6	
--------------	----	---------------	---	-------	--

1.6 4x4	92	01/92 → 10/95	B	D16Z7	
---------	----	---------------	---	-------	--

1.6 EX	88	08/93 → 10/95	B	D16A7	
--------	----	---------------	---	-------	--

1.6 i	77	01/94 → 11/95	B	D16Y7	
-------	----	---------------	---	-------	--

1.6 i Vtec	92	01/94 → 03/96	B	D16Y6, D16Z9	
------------	----	---------------	---	-----------------	--

**Civic VI, Hatchback, Aerodeck, Fastback, Coupé**

1.4	55	11/95 → 10/98	B	D14A4	
-----	----	---------------	---	-------	--

1.4	55	09/95 → 02/01	B	D14A5, D14A7, D14Z3	
-----	----	---------------	---	---------------------------	--

1.4 i	66	09/94 → 02/01	B	D14A2, D14A6, D14A8, D14Z4	
-------	----	---------------	---	-------------------------------------	--

1.4 i	66	11/95 → 02/01	B	D14A4, D14Z2, D14Z4	
-------	----	---------------	---	---------------------------	--

**81613**
**350981613000**

**KW**

**HONDA**
**Civic VI, Hatchback, Aerodeck, Fastback, Coupé**

1.4 i S	66	11/95 → 02/01	B	D14A4, D14Z2, D14Z4	
---------	----	---------------	---	---------------------------	--

1.5 i Vtec-E	66	09/94 → 01/97	B	D15Z3	
--------------	----	---------------	---	-------	--

1.6	93	10/95 → 09/00	B	D16Y2	
-----	----	---------------	---	-------	--

1.6 i	83	09/94 → 01/97	B	D16Y3	
-------	----	---------------	---	-------	--

1.6 i Vtec	93	09/94 → 01/97	B	D16Y2	
------------	----	---------------	---	-------	--

**Concerto**

1.4	61	10/89 → 10/92	B	D14A1	
-----	----	---------------	---	-------	--

1.4	66	08/89 → 10/91	B	D14A1, D14A8	
-----	----	---------------	---	-----------------	--

1.5 i 16V	66	08/89 → 03/95	B	D15B2	
-----------	----	---------------	---	-------	--

1.6	96	10/89 → 10/92	B	D16A9	
-----	----	---------------	---	-------	--

1.6 16V	78	08/89 → 03/95	B	D16Z2	
---------	----	---------------	---	-------	--

1.6 i 16V	82	08/89 → 03/95	B	D16Z2	
-----------	----	---------------	---	-------	--

1.6 i 16V	90	08/89 → 03/95	B	D16A8	
-----------	----	---------------	---	-------	--

**CRX II**

1.6 i 16V	91	10/87 → 02/92	B	D16Z5	
-----------	----	---------------	---	-------	--

**CRX II**

1.6 i 16V Vtec	110	10/89 → 02/92	B	B16A1	
-------------------	-----	---------------	---	-------	--

1.6 ESi	92	03/92 → 12/98	B	D16Y8, D16Z6	
---------	----	---------------	---	-----------------	--

1.6 i VTi	118	03/92 → 12/98	B	B16A2	
-----------	-----	---------------	---	-------	--

**ROVER**
**200 II, Coupé**

216	90	10/92 → 06/99	B	D16A8	
-----	----	---------------	---	-------	--

216 GSi	82	10/89 → 10/95	B	D16Z2	
	85	10/89 → 10/95	B	D16A7	

216 GTi	90	09/90 → 10/95	B	D16A8	
	96	09/90 → 10/95	B	D16A9	

**400 I, Station Wagon**

1.6 i	82	05/94 → 11/98	B	D16Z2	→ 02-1996
-------	----	---------------	---	-------	-----------

1.6 i	90	05/94 → 11/98	B	D16A8	→ 02-1996
-------	----	---------------	---	-------	-----------

416 GSi	82	04/90 → 04/95	B	D16Z2	
---------	----	---------------	---	-------	--

416 GSi/ GSE	85	04/90 → 04/95	B	D16A7	
-----------------	----	---------------	---	-------	--

416 GTi	90	04/90 → 04/95	B	D16A8	
---------	----	---------------	---	-------	--

416 GTi/ GTE	96	04/90 → 04/95	B	D16A9	
-----------------	----	---------------	---	-------	--

**Cabriolet**

216 1.6i	90	01/92 → 11/99	B	D16A8	
----------	----	---------------	---	-------	--

216 1.6i 16V	82	01/96 → 11/99	B	16K4F	
--------------	----	---------------	---	-------	--

**81614**
**350981614000**

**PULEGGIA**

Diametro Puleggia Ø59.45  
 Numero Denti/Gole Puleggia 24  
 Altezza Puleggia 32.5  
 Posizione Attacco 45  
 Diametro Girante Ø58.5  
 N° Alette Girante 6  
 Posizione Girante 16.5

**KW**

**ROVER**
**100**

111	44	04/94 → 10/97	B	11K2D	
114	55	04/94 → 10/97	B	14K2A, 14K2D	

**100 (Metro)**

111 C/L/S	44	03/90 → 12/98	B	11K2A, 11K2D	
114 S/L/ GTA	55	03/90 → 12/98	B	14K2A, 14K2D	

**200 II, Coupé**

214	55	09/93 → 10/95	B	14K2A, 14K2D	
-----	----	---------------	---	-----------------	--

**200 III**

211	44	01/98 → 03/00	B	11K2D	
214 i	55	11/95 → 03/00	B	14K2F	03-1996 →

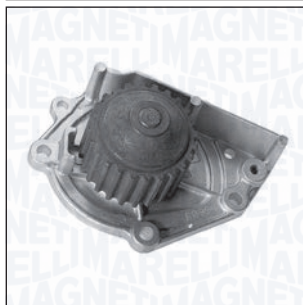
**81615**
**350981615000**

**PULEGGIA**

Diametro Puleggia Ø59.45  
 Numero Denti/Gole Puleggia 24  
 Altezza Puleggia 32.5  
 Posizione Attacco 45  
 Diametro Girante Ø58.5  
 N° Alette Girante 6  
 Posizione Girante 16.5

**KW**

**LOTUS**
**Elise I**

1.8	88	08/95 → 11/00	B	18K4F	
111 S	107	03/99 → 11/00	B	18K4K	

**MG**
**MG TF**

115	85	03/02 → 12/09	B	16K4F	
120	88	03/02 → 12/09	B	18K4F	
135	100	03/02 → 12/09	B	18K4F	
160	118	03/02 → 12/09	B	18K4K	

**81615**
**350981615000**

**KW**

**MG**
**MG ZR**

105	76	06/01 → 04/05	B	14K4F	
120	86	06/01 → 04/05	B	18K4F	
160	118	06/01 → 04/05	B	18K4K	

**MG ZS**

120	86	07/01 → 04/05	B	18K4F	
-----	----	---------------	---	-------	--

**MGF**

1.8 i VVC	118	10/01 → 03/02	B	18K4K	
1.6	82	02/00 → 03/02	B	16K4F	
1.8 i 16V	88	03/95 → 03/02	B	18K4F	
1.8 i VVC	107	03/95 → 03/02	B	18K4K	

**ROVER**
**25**

1.1 16V	55	01/04 → 05/05	B	11K4F	
1.4 16V	62	10/99 → 05/05	B	14K4M	
	76	10/99 → 05/05	B	14K4F	
1.6 16V	80	10/99 → 05/05	B	16K4F	
1.8 16V	85	10/99 → 05/05	B	18K4F	
	107	02/00 → 05/05	B	18K4K	

**45**

1.4	76	02/00 → 05/05	B	14K4F	
1.6	80	02/00 → 05/05	B	16K4F	
1.8	86	02/00 → 05/05	B	18K4F	

**75, Station Wagon**

1.8	88	02/99 → 05/05	B	K1.8	
1.8 Turbo	110	05/03 → 05/05	B	18K4G	

**100**

114	75	03/97 → 10/98	B	14K4F	
-----	----	---------------	---	-------	--

**100 (Metro)**

114 GSi	76	10/94 → 10/95	B	14K4F	
114 GTI 16V	69	03/90 → 08/91	B	14K4C, 14K4D	
114 GTI 16V	76	08/91 → 12/98	B	14K4F	
114 GTI/GT 16V Cat.	66	03/90 → 12/98	B	14K4C, 14K4D	

**200 II, Coupé**

214 GSi/Si	70	01/90 → 10/95	B	14K4C	
	76	12/92 → 10/95	B	14K4F	
214 Si/Gsi	66	10/89 → 10/95	B	14K4C, 14K4D	

**200 III**

214 Si	76	11/95 → 03/00	B	14K4F	
216 Si	82	11/95 → 03/00	B	16K4F	
218 K Vi	107	11/95 → 03/00	B	18K4K	

**81615**
**350981615000**

**KW**

**ROVER**
**400 I, Station Wagon**

1.6 i	82	05/94 → 11/98	B	D16Z2	03-1996 →
	90	05/94 → 11/98	B	D16A8	03-1996 →
1.8 i	107	06/96 → 11/98	B	18K4K	
414	70	01/93 → 04/95	B	14K4C	
414 GSI/SI	66	04/90 → 04/95	B	14K4C, 14K4D	
414 GSI/SI Cat.	76	01/93 → 04/95	B	14K4F	

**400 II**

414 Si	76	05/95 → 03/00	B	14K4F	
416 Si	82	05/95 → 03/00	B	16K4F	
	83	05/95 → 03/00	B	D16Y2	

**Cabriolet**

214 1.4	66	01/92 → 11/99	B	14K4C, 14K4D	
	70	04/90 → 09/92	B	14K4C	
214 1.4i 16V	76	01/93 → 11/99	B	14K4F	

**Coupé**

1.6 16 V	82	03/96 → 11/99	B	16K4F	
1.8 16 V	107	03/96 → 11/99	B	18K4K	

**Streetwise**

1.4	62	08/03 → 05/05	B	14K4M	
	76	08/03 → 05/05	B	14K4F	

**81616**
**350981616000**

**KW**

**FLANGIA**

Numero Fori Flangia	4
Dimensione Fori Flangia	M6×1
Posizione Attacco	106.8
Diametro Mozzo	M24×1.5 SX
Diametro Centraggio	Ø40
Diametro Girante	Ø70
N° Alette Girante	7
Posizione Girante	10.5

**KW**

**BMW**
**3 II (E30), Touring, Cabrio**

320 i	95	04/86 → 10/93	B	M20B20 (206KA)	10-1987 →
	110	12/85 → 06/90	B	M20B20 (206KA)	10-1987 →
320 i	95	01/88 → 12/91	B	M20B20 (206KA)	
	95	12/85 → 06/91	B	M20B20 (206KA), M20B20 (L-Jetronic)	10-1987 →
320 is	141	05/88 → 12/90	B	S14B20 (204EA)	
325 i	125	12/86 → 06/91	B	M20B25 (256E1), M20B25 (256E2), M20B25 (256EX), M20B25 (256K1)	10-1987 →
	125	09/87 → 10/93	B	M20B25 (256E2), M20B25 (256EX), M20B25 (256K1)	
	125	07/87 → 03/93	B	M20B25 (256K1)	
325 i X	125	12/86 → 08/91	B	M20B25 (256E1), M20B25 (256E2), M20B25 (256EX), M20B25 (256K1)	10-1987 →
	125	06/88 → 10/93	B	M20B25 (256K1)	

## 81616 350981616000



### BMW

#### 5 III (E34), Touring

520 i	95	01/88 → 08/91	B	M20B20 (206KA)	
525 i	125	01/88 → 08/91	B	M20B25 (256K1)	

### Z1

2.5	125	06/88 → 06/91	B	M20B25 (256K1)	11-1988 →, → 10-1991
-----	-----	---------------	---	-------------------	-------------------------

## 81617 350981617000



### FLANGIA

Numero Fori Flangia	4
Dimensione Fori Flangia	M6×1
Posizione Attacco	107
Diametro Mozzo	M24×1.5 SX
Diametro Centraggio	Ø40
Diametro Girante	Ø74
N° Alette Girante	7
Posizione Girante	11



### BMW

#### 5 III (E34), Touring

524 td	85	03/88 → 09/95	D	M21D24, M21D24 (246TB)	03-1988 →, → 09-1991
--------	----	---------------	---	------------------------------	-------------------------

## 81618 350981618000



### FLANGIA

Numero Fori Flangia	4
Dimensione Fori Flangia	M6×1
Posizione Attacco	99.5
Diametro Mozzo	M24×1.5 SX
Diametro Centraggio	Ø40
Diametro Girante	Ø75
N° Alette Girante	7
Posizione Girante	-0.5



### BMW

#### 5 III (E34), Touring

530 i	138	01/88 → 08/91	B	M30B30 (306KA)	03-1988 →, → 08-1990
535 i	155	01/88 → 09/95	B	M30B34 (346KB)	
M5	232	10/88 → 05/92	B	S38B36 (366S1)	

## 81618 350981618000



### BMW

#### 5 III (E34), Touring

M5 Cat.	232	10/88 → 05/92	B	S38B36 (366S1)	03-1988 →, → 06-1994
---------	-----	---------------	---	-------------------	-------------------------

#### 6 I (E24)

635 CSi	141	04/85 → 09/90	B	M30B35	09-1979 →, → 12-1988
---------	-----	---------------	---	--------	-------------------------

#### 7 II (E32)

730 i,iL	138	12/86 → 09/94	B	M30B30 (306KA)	
	145	12/86 → 09/94	B	M30B30 (306EA)	
735 i,iL	155	09/86 → 09/92	B	M30B34 (346KB)	

## 81619 350981619000



### PULEGGIA

Diametro Puleggia	Ø62.3
Numero Denti/Gole Puleggia	21
Altezza Puleggia	26.5
Posizione Attacco	47
Diametro Girante	Ø63
N° Alette Girante	6
Posizione Girante	52.5



### LADA

#### Samara

1100	39	02/88 → 12/94	B	BA321081	→ 02-1992
1300	45	09/91 →	B	BA32108	→ 02-1992
	48	01/86 → 12/94	B	BA32108	→ 02-1992
1500	50	09/91 →	B	BA321083	→ 02-1992

#### Samara Forma

1100	39	07/91 →	B	BA321081	→ 02-1992
1300	45	07/91 →	B	BA32108	→ 02-1992
	46	05/90 →	B	BA32108	→ 02-1992
	48	05/89 → 07/97	B	BA32108	→ 02-1992
1500	50	07/91 →	B	BA321083	→ 02-1992
	53	09/91 →	B	BA321083	→ 02-1992

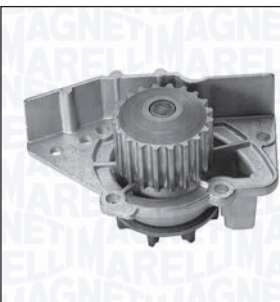
**81642**
**350981642000**

**PULEGGIA**

Diametro Puleggia Ø59.26  
 Numero Denti/Gole Puleggia 20  
 Altezza Puleggia 33.5  
 Posizione Attacco 42.5  
 Diametro Girante Ø69  
 N° Alette Girante 8  
 Posizione Girante 41.3

**KW**

**CITROËN**
**Berlingo I, Van**

1.8 D	43	07/96 →	D	A9A (XUD7)	07-1996 →
	43	07/98 →	D	A9A (XUD7)	

1.9 D	50	07/96 →	D	D9B (XUD9A/L), DJY (XUD9A)	07-1996 →
	51	07/96 → 10/99	D	DJY (XUD9A)	
	51	07/96 →	D	DJY (XUD9A)	07-1996 →

**C 15**

1.8 D	44	07/86 → 12/00	D	161A (XUD7)	PROD →: 6265
-------	----	---------------	---	-------------	--------------

**Evasion**

1.9 TD	66	11/94 → 07/02	D	D8B (XUD9TF), DHX (XUD9TF/BTF)	
	68	10/95 → 12/98	D	D8B (XUD9TF)	
2.0	89	06/94 → 07/02	B	RFU (XU10J2/C)	06-1994 →
2.0 Turbo C.T.	108	06/94 → 07/02	B	RGX (XU10J2TE)	06-1994 →

**Jumper I**

1.9 D	50	07/99 → 04/02	D	DJY (XUD9A)	
	51	01/99 → 04/02	D	D9B (XUD9A/U)	
1.9 TD	66	08/94 → 04/02	D	D8C (XUD9UTF)	
	66	03/94 → 04/02	D	DHX (XUD9TF/BTF)	
	68	02/94 → 04/02	D	D8C (XUD9UTF)	

**81642**
**350981642000**

**KW**

**CITROËN**
**Jumper I**

1.9 TD 4x4	68	08/96 → 04/02	D	D8C (XUD9UTF)	
2.0	80	02/94 → 04/02	B	RFW (XU10J2U)	
2.0 4x4	80	08/96 → 04/02	B	RFW (XU10J2U)	

**Jumper II**

2.0	81	04/02 →	B	XU10J2	
2.0 bivalent	81	02/03 →		XU10J2	

**Jumpy I**

1.9 D	51	10/95 → 04/98	D	D9B (XUD9A/U)	10-1995 →
	51	10/95 → 08/98	D	D9B (XUD9A/U)	
1.9 DT	65	10/95 → 08/00	D		
1.9 TD	66	10/95 →	D	DHX (XUD9TF/BTF)	10-1995 →
	66	10/95 →	D	DHX (XUD9TF/BTF)	
	68	04/96 →	D	D8B (XUD9TF)	

**Jumpy II**

1.9 TD	68	10/99 →	D	D8B (XUD9TF)	
--------	----	---------	---	--------------	--

**Xantia I, Break**

1.9 D	50	06/94 → 01/98	D	DJZ (XUD9Y)	PROD →: 6265
	51	06/94 → 01/98	D	D9B (XUD9A/L)	PROD →: 6265
1.9 SD	55	02/96 → 01/98	D	DHW (XUD9SD)	PROD →: 6265
1.9 Turbo D	66	06/95 → 01/98	D	D8B (XUD9TF), DHX (XUD9TF/BTF), DHY (XUD9TE/Y)	PROD →: 6265
	66	10/94 → 01/98	D	DHX (XUD9TF/BTF), DHY (XUD9TE/Y)	PROD →: 6265

**81642**
**350981642000**

**KW**

**CITROËN**
**Xantia I, Break**

2.0 i	89	03/93 → 01/98	B	RFX (XU10J2C)	03-1993 →, → 05-1995
	89	06/95 → 01/98	B	RFX (XU10J2C)	
2.0 i 16V	97	06/95 → 01/98	B	RFV (XU10J4R)	→ 10-1996
	110	06/94 → 01/98	B	RFT (XU10J4Z)	06-1995 →, → 10-1996
	112	03/93 → 01/98	B	RFY (XU10J4Z)	03-1993 →
2.0 Turbo	108	06/95 → 01/98	B	RGX (XU10J2TE)	06-1995 →

**Xantia II, Break**

1.9 SD	55	01/98 → 04/03	D	DHW (XUD9SD)	
1.9 Turbo D	66	01/98 → 04/03	D	D8B (XUD9TF), DHX (XUD9TF/ BTF)	
	66	01/98 → 04/03	D	DHX (XUD9TF/ BTF), DHY (XUD9TE/Y)	
2.0 i	89	01/98 → 04/03	B	RFX (XU10J2C)	
2.0 Turbo	108	01/98 → 04/03	B	RGX (XU10J2TE)	

**XM I, Break**

2.0	84	05/89 → 04/94	B		
2.0 i	79	05/89 → 04/94	B	RDZ (XU10MZ)	
	89	05/89 → 06/94	B	RFZ (XU10J2)	
2.0 i Turbo	104	09/92 → 06/94	B	RGY (XU10J2TEZ)	01-1993 →, → 05-1994
2.0 Turbo	104	09/92 → 04/94	B	RGY (XU10J2TEZ)	
2.1 D 12V	60	05/89 → 06/94	D	P9A (XUD11A)	

**81642**
**350981642000**

**KW**

**CITROËN**
**XM II, Break**

2.0 Turbo	108	05/94 → 10/00	B	RGX (XU10J2TE)	
	108	05/94 → 10/00	B	RGX (XU10J2TE), RGY (XU10J2TE/Z)	
2.1 D12	60	07/94 → 06/96	D	P9A (XUD11A)	
2.1 D12 VSX	60	03/96 → 08/96	D	P9A (XUD11A)	

**Xsara, Break, Coupé, Picasso, Van**

1.8 D	43	04/97 → 09/00	D	161A(XUD7), A9A (XUD7)	
	43	10/97 → 09/00	D	A9A (XUD7)	
1.8 TD	66	10/97 → 09/00	D		
1.9 D	50	04/97 → 09/00	D	DJY (XUD9A)	
	55	01/98 → 09/00	D	DHV (XUD9BSD)	
1.9 SD	55	01/98 → 09/00	D	DHV (XUD9BSD)	
1.9 TD	66	04/97 → 09/00	D	DHY (XUD9TE/Y)	

**ZX, Break**

1.8 D	44	06/93 → 06/97	D	161A(XUD7)	
1.9 D	47	03/91 → 06/97	D	DJZ (XUD9Y)	07-1994 →, PROD →: 6171
	50	06/94 → 10/97	D	D9B (XUD9A/U)	07-1994 →, PROD →: 6.171
	50	07/93 → 06/97	D	D9B (XUD9A/U), DJY (XUD9A)	07-1994 →, PROD →: 6.171
1.9 TD	66	07/92 → 06/97	D	DHY (XUD9TE/Y)	07-1994 →, PROD →: 6171
2.0 i	89	07/92 → 06/97	B	RFX (XU10J2C)	

**FIAT**
**Ducato III**

1.9 D	50	04/98 → 04/02	D	D9B, D9B (XUD9A), DJY	
	50	04/98 → 04/02	D	DJY	
1.9 TD	66	04/98 → 04/02	D	DHX (XUD9TF/L)	
2.0	80	03/94 → 04/02	B	RFW	



**81642 350981642000**

**FIAT**
**Ducato III**

2.0 4x4	80	11/94 → 11/01	B	RFW	
2.0 Panorama/ Combinato	80	03/94 → 04/02	B	RFW	

**Ducato IV**

2.0	81	04/02 →	B	RFL	
2.0 4x4	81	05/02 → 07/06	B	RFL	
2.0 Bipower	81	11/02 →		RFL	

**Scudo I**

1.9 D	51	04/98 → 12/06	D	WJY (DW8B), WJZ (DW8)	
	51	04/98 → 12/06	D	WJZ (DW8)	
	51	02/96 → 04/98	D	D9B	
1.9 TD	66	02/96 → 12/06	D	DHX (XUD9TF/L)	
	68	02/96 → 12/06	D	D8B	
1.9 TD Eco	66	02/96 → 12/06	D	DHX (XUD9TF/L)	

**Ulysse I**

1.9 TD	66	02/95 → 08/02	D	DHX (XUD9TF/L)	05-1995 →
2.0	89	06/94 → 08/02	B	RFU (XU10J2C)	
2.0 Turbo	108	06/94 → 08/02	B	RGX (XU10J2CTE)	

**HYUNDAI**
**Lantra II, Station Wagon**

1.9 D	50	03/98 → 09/00	D	DJY	
-------	----	---------------	---	-----	--

**LANCIA**
**Zeta**

2.0 Turbo	108	05/95 → 09/02	B	RGX (XU10J2TE)	
-----------	-----	---------------	---	----------------	--

**PEUGEOT**
**205 II, Van**

1.7 Diesel	44	03/94 →	D	161A (XUD7)	
------------	----	---------	---	-------------	--

**306, Station Wagon, Coupé, Cabrio, Van**

1.8 D	43	05/93 → 05/01	D	A9A (XUD7)	PROD →: 7391
1.9 D	47	05/93 → 05/01	D	DJZ (XUD9Y)	PROD →: 7391
	50	06/94 → 05/01	D	DJY (XUD9A)	PROD →: 7391
	55	03/98 → 05/01	D	DHV (XUD9BSD)	PROD →: 7391
1.9 DT	66	05/93 → 05/01	D	DHY (XUD9TE)	PROD →: 7391

**81642 350981642000**

**PEUGEOT**
**306, Station Wagon, Coupé, Cabrio, Van**

1.9 SLD	47	06/94 → 05/01	D	DJZ (XUD9Y)	PROD →: 7391
	50	06/94 → 05/01	D	DJY (XUD9A)	PROD →: 7391
1.9 SRDT	66	06/94 → 05/01	D	DHY (XUD9TE)	PROD →: 7391
1.9 TD	66	02/97 → 04/02	D	DHY (XUD9TE)	PROD →: 7391
2.0	89	03/94 → 04/02	B	RFX (XU10J2)	
2.0 S16	110	06/94 → 05/01	B	RFT (XU10J4)	
	112	06/94 → 05/01	B	RFY (XU10J4Z)	
2.0 ST	89	07/94 → 05/01	B	RFX (XU10J2)	
2.0 XSi	89	05/93 → 05/01	B	RFX (XU10J2)	

**405 II, Station Wagon**

2.0	89	08/92 → 10/95	B	RFX (XU10J2)	
2.0 16V	110	06/94 → 10/95	B	RFT (XU10J4)	
2.0 4x4	89	08/92 → 10/96	B	RFX (XU10J2)	
2.0 MI-16	112	08/92 → 10/95	B	RFY (XU10J4Z)	
2.0 T 16 X4	144	08/92 → 10/95	B	RGZ (XU10J4TEZ)	
2.0 X4	89	08/92 → 10/95	B	RFX (XU10J2)	

**407, Station Wagon, Coupé**

1.9 D	55	10/96 → 05/04	D	DHW (XUD9SD)	
1.9 TD	66	01/96 → 05/04	D	DHX (XUD9TE)	
	68	01/96 → 05/04	D	DHY (XUD9TE)	
2.0 Turbo	108	04/96 → 05/04	B	RGX (XU10J2TE)	

**605**

2.0	79	02/90 → 09/99	B		
	84	06/89 → 09/99	B	R5A (XU102C)	
	89	06/89 → 09/99	B	RFZ (XU10J2Z)	

**81642**
**350981642000**

**KW**

**PEUGEOT**
**605**

2.0 Turbo	104	07/92 → 09/99	B	RGY (XU10J2TE)
	108	07/91 → 09/99	B	RGX (XU10J2TE)
2.1 D	60	06/89 → 07/95	D	P9A (XUD11A)

**806**

1.9 TD	66	07/95 → 08/02	D	DHX (XUD9TE)
	68	05/97 → 08/02	D	DHY (XUD9TE)
2.0	89	06/94 → 08/02	B	RFU (XU10J2)
2.0 Turbo	108	06/94 → 08/02	B	RGX (XU10J2TE)

**Boxer I**

1.9 D	50	07/99 → 04/02	D	DJY (XUD9A)
	51	03/94 → 04/02	D	D9B (XUD9AU)
1.9 DT 4x4	66	03/96 → 09/98	D	XUD9TE
1.9 TD	66	08/94 → 04/02	D	DHY (XUD9TE)
1.9 TD	66	06/94 → 04/02	D	DHY (XUD9TE), XUD9TE
	66	07/99 → 04/02	D	XUD9TE
	68	03/94 → 04/02	D	D8C (XUD9UTF)
	68	07/94 → 04/02	D	D8C (XUD9UTF), XUD9TE
1.9 TD 4x4	68	07/96 → 04/02	D	D8C (XUD9UTF)
2.0	81	12/01 → 04/02	B	RFL (XU10J2U)
2.0 4x4	80	03/96 → 09/98	B	
2.0 i	80	03/94 → 04/02	B	RFW (XU10J2)
2.0 i 4x4	80	08/96 → 04/02	B	RFW (XU10J2)

**Boxer II**

2.0	81	04/02 →	B	RFL (XU10J2U)
-----	----	---------	---	------------------

**81642**
**350981642000**

**KW**

**PEUGEOT**
**Expert I**

1.9 D	51	06/98 → 11/03	D	WJY (DW8B), WJZ (DW8)
	51	02/96 →	D	D9B (XUD9AU)
1.9 TD	66	02/96 →	D	DHX (XUD9TE)
	68	02/96 →	D	D8B (XUD9TE)

**Partner I**

1.8 D	44	11/96 → 02/98	D	A9A (XUD7)
1.9 D	51	12/98 →	D	WJY (DW8B), WJZ (DW8)
	50	06/96 →	D	DJY (XUD9A)
	51	06/96 →	D	DJY (XUD9A)
	51	05/96 → 12/98	D	XUD9

**SUZUKI**
**Baleno, Station Wagon**

1.9 TD	55	04/98 → 05/02	D	DHV (XUD9BSD), DHW (XUD9SD)
	55	04/98 → 05/02	D	DHW (XUD9SD)

**Samurai**

1.9 TD	46	11/98 → 12/04	D	XUD9
--------	----	---------------	---	------

**Vitara**

1.9 D	50	01/95 → 03/98	D	XUD9A
	55	08/96 → 03/99	D	XUD9SD
1.9 D Trazione integrale	50	01/95 → 03/98	D	XUD9A
	55	08/96 → 03/98	D	XUD9SD

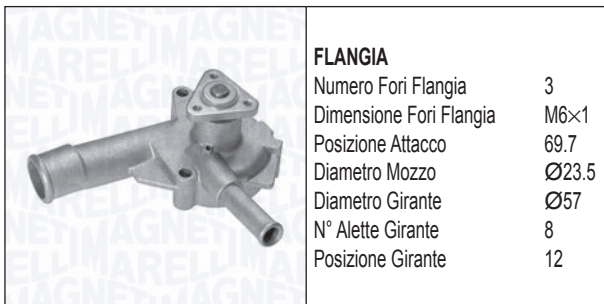
**81650**
**350981650000**

**FLANGIA**

Numero Fori Flangia	3
Dimensione Fori Flangia	M6×1
Posizione Attacco	69.7
Diametro Mozzo	Ø23.5
Diametro Girante	Ø57
N° Alette Girante	8
Posizione Girante	12

**KW**

**FORD**
**Escort IV, Station Wagon, Cabrio, Express**

1.3	44	02/86 → 07/90	B	JBB, JLA, JLB	
	46	07/88 → 07/90	B	JBA	
	46	07/88 → 10/90	B	JBA	02-1986 →, → 04-1991

**Escort V, Station Wagon, Cabrio, Express**

1.3	44	07/90 → 09/92	B	J4B, J6A	→ 04-1991
-----	----	---------------	---	----------	-----------

**Fiesta III, Van**

1.0	33	03/89 → 12/95	B	TLB	→ 04-1991
1.1	37	03/89 → 12/95	B	G6A	→ 04-1991
	40	03/89 → 12/95	B	GUD, GUE	→ 04-1991
1.3	44	03/89 → 12/92	B	JBC	→ 04-1991

**Orion III**

1.3	44	07/90 → 12/93	B	J4B, J6A	→ 04-1991
-----	----	---------------	---	----------	-----------

**81651**
**350981651000**

**PULEGGIA**

Diametro Puleggia	Ø50
Altezza Puleggia	23
Posizione Attacco	38.5
Diametro Girante	Ø71.5
N° Alette Girante	9
Posizione Girante	12.5

**KW**

**FORD**
**Escort IV, Station Wagon, Cabrio, Express**

1.8 D	44	07/88 → 07/90	D	RTA, RTB	
	44	01/89 → 07/90	D	RTA, RTB	01-1990 →

**Escort V, Station Wagon, Cabrio, Express**

1.8 D	44	07/90 → 12/92	D	RTE, RTF, RTH	
	44	07/90 → 12/94	D	RTH	

**81651**
**350981651000**

**KW**

**FORD**
**Escort VI, Station Wagon, Cabrio**

1.8 D	44	09/92 → 01/95	D	RTE, RTF, RTH	
	44	08/93 → 01/95	D	RTE, RTF, RTH	01-1990 →
	44	09/92 → 01/95	D	RTH	01-1990 →

**Escort VII, Station Wagon, Cabrio, Express**

1.8 D	44	01/95 → 12/96	D	RTE, RTF, RTH	
	44	01/95 →	D	RTF, RTH	

**Fiesta II, Van**

1.8 D	43	03/89 → 12/95	D	RTC, RTD, RTG	
-------	----	---------------	---	---------------	--

**Fiesta III, Van**

1.8 D	44	09/91 → 02/96	D	RTC, RTD, RTG	
-------	----	---------------	---	---------------	--

**Fiesta IV, Van**

1.8 D	44	08/95 → 04/00	D	RTJ, RTK	
	44	02/96 → 04/02	D	RTK	01-1989 →
D 1.8	44	05/98 → 04/02	D	RTJ, RTK	

**Orion II**

1.8 D	44	01/89 → 07/90	D	RTA, RTB	
-------	----	---------------	---	----------	--

**Orion III**

1.8 D	44	11/90 → 12/93	D	RTE, RTF, RTH	
-------	----	---------------	---	---------------	--

**MAZDA**
**121**

1.8 D	44	03/96 → 04/03	D	RTJ, RTK	
-------	----	---------------	---	----------	--

**81653**
**350981653000**

**FLANGIA**

Numero Fori Flangia	3
Dimensione Fori Flangia	M6×1
Posizione Attacco	76.25
Diametro Mozzo	Ø23.5
Diametro Girante	Ø57
N° Alette Girante	8
Posizione Girante	12

**KW**

**FORD**
**Escort V, Station Wagon, Cabrio, Express**

1.3	44	07/90 → 09/92	B	J4B, J6A	05-1991 →
	44	09/91 → 09/92	B	J4B, J6A	
	46	07/90 → 12/94	B	JBD	05-1991 →

**81653**
**350981653000**

**FORD**
**Escort VI, Station Wagon, Cabrio**

1.3 44 09/92 → 01/95 B J4B, J6A

**Escort VII, Station Wagon, Cabrio, Express**

1.3 44 01/95 → 10/98 B J4B, J6A

**Fiesta III, Van**

1.0 33 03/89 → 12/95 B TLB 05-1991 →

1.1 37 03/89 → 12/95 B G6A 05-1991 →

1.1 40 03/89 → 12/95 B GUD, GUE 05-1991 →

1.3 44 09/91 → 02/96 B J6B

1.3 44 03/89 → 12/92 B JBC 05-1991 →

1.3 Cat. 44 05/91 → 01/97 B J6B

**Fiesta IV, Van**

1.3 44 02/96 → B J4C

**Orion III**

1.3 44 07/90 → 12/93 B J4B, J6A 05-1991 →

**81654**
**350981654000**

**FORD**
**Sierra II, Station Wagon**

2.0 i 85 01/87 → 02/93 B N4A, N4I → 01-1991

88 01/90 → 02/93 B N9C → 01-1991

92 06/89 → 02/93 B N9B → 01-1991

92 01/90 → 02/93 B N9C → 01-1991

**Transit VII**

2.3 105 03/01 → 03/06 B E5FC

107 08/00 → 03/06 B E5FA

2.3 16V 107 04/01 → 05/06 B E5FA, E5FC

2.3 16V [RWD] 107 08/00 → 05/06 B E5FA, E5FC

**Transit XIII**

2.3 16V [RWD] 107 04/06 → 08/14 B GZFA, GZFB, GZFC

**81654**
**350981654000**

**FLANGIA**

Numero Fori Flangia 4  
 Dimensione Fori Flangia M8×1.25  
 Posizione Attacco 102.6  
 Diametro Mozzo Ø23.4  
 Diametro Girante Ø65  
 N° Alette Girante 8  
 Posizione Girante 34.25

**FORD**
**Escort V, Station Wagon, Cabrio, Express**

RS 2000 110 05/91 → 12/92 B N7A → 06-1991

**Scorpio I, Station Wagon**

2.0 77 03/90 → 08/92 B N8B → 01-1991

80 11/88 → 10/92 B N8A → 01-1991

80 06/89 → 03/93 B N8B → 01-1991

2.0 i 85 04/85 → 02/92 B NRA, NRI 01-1989 →, → 01-1991

88 05/89 → 09/94 B N9D → 01-1991

92 05/89 → 02/92 B N9B → 01-1991

**Scorpio II, Station Wagon**

2.3 i 16V 108 06/96 → 08/98 B Y5A

**Sierra II, Station Wagon**

2.0 77 01/87 → 02/93 B N8C, NES → 01-1991

2.0 4x4 88 02/90 → 02/93 B N9C → 01-1991

92 01/90 → 02/93 B N9C → 01-1991

**81655**
**350981655000**

**FLANGIA**

Numero Fori Flangia 4  
 Dimensione Fori Flangia M6×1  
 Posizione Attacco 82.85  
 Diametro Centraggio Ø58  
 Diametro Girante Ø82  
 N° Alette Girante 6  
 Posizione Girante 9.5

**FORD**
**Escort V, Station Wagon, Cabrio, Express**

1.8 16V 77 02/92 → 12/92 B RDA

1.8 16V XR3i 77 02/92 → 12/92 B RDA

96 02/92 → 12/92 B RQB

**Escort VI, Station Wagon, Cabrio**

1.6 16V XR3i 66 12/92 → 01/95 B L1E

65 01/94 → 01/95 B L1H

1.6 i 16V 66 09/92 → 01/95 B L1E

66 08/93 → 01/95 B L1E, L1K

1.8 16V XR3i 77 12/92 → 01/95 B RDA

96 09/92 → 01/95 B RQB

77 09/92 → 01/95 B RDA

1.8 i 16V 77 01/93 → 01/95 B RDA 01-1990 →

96 02/93 → 01/95 B RQB

1.8 XR3i 77 08/93 → 01/95 B RDA

16V 4x4 96 08/93 → 01/95 B RQB

**81655** **350981655000**

**FORD**
**Escort VII, Station Wagon, Cabrio, Express**

1.6 16V	66	01/95 → 10/98	B	L1E
1.6 16V 4x4	66	01/95 → 10/98	B	L1E
1.6 16V XR3i	65	02/95 → 12/96	B	L1H
	66	02/95 → 09/99	B	L1E
1.6 i 16V	65	01/95 → 08/95	B	L1H
	66	01/95 → 02/99	B	L1E, L1K
1.8 16V	77	01/95 → 08/95	B	RDA
	85	01/95 → 10/98	B	RKC
1.8 16V XR3i	77	02/95 → 08/98	B	RDA
	85	10/95 → 08/98	B	RKC
	96	02/95 → 08/00	B	RQB

**Fiesta III, Van**

1.6 i 16V	65	01/94 → 12/95	B	L1G
1.8 16V	77	02/92 → 12/95	B	RDB
1.8 XR2i 16V	96	02/92 → 12/95	B	RQC

**Orion III**

1.6 i 16V	66	07/92 → 12/93	B	L1E, L1K
1.8 i 16V	77	02/92 → 12/93	B	RDA
	96	01/92 → 12/93	B	RQB

**81656** **350981656000**

**PULEGGIA**

Diametro Puleggia	Ø50
Altezza Puleggia	23
Posizione Attacco	64.5
Diametro Girante	Ø79
N° Alette Girante	9
Posizione Girante	11.5

**FORD**
**Mondeo I, Station Wagon**

1.8 TD	65	06/93 → 08/96	D	RFM, RFN
	66	10/95 → 08/96	D	RFM, RFN

**Mondeo II, Station Wagon**

1.8 TD	66	08/96 → 09/00	D	RFN
--------	----	---------------	---	-----

**81657** **350981657000**

**PULEGGIA**

Diametro Puleggia	Ø50
Altezza Puleggia	23
Posizione Attacco	64.5
Diametro Girante	Ø79
N° Alette Girante	9
Posizione Girante	11.5

**FORD**
**Escort Classic**

1.8 TD	66	10/98 → 07/00	D	RFD, RFK
--------	----	---------------	---	----------

**Escort VI, Station Wagon, Cabrio**

1.8 TD	66	02/93 → 01/95	D	RFD, RFK
	66	02/93 → 01/95	D	RFD, RFK, RFS

**Escort VII, Station Wagon, Cabrio, Express**

1.8 TD	66	01/95 → 10/98	D	RFD, RFK
1.8 Turbo D	51	12/95 → 06/01	D	RVA

**Fiesta III, Van**

1.8 TD	55	03/93 → 12/95	D	RFL
--------	----	---------------	---	-----

**Orion III**

1.8 TD	66	03/92 → 12/93	D	RFD, RFK
--------	----	---------------	---	----------

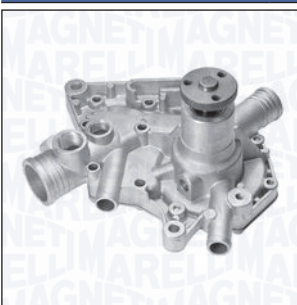
**81660** **350981660000**

**FLANGIA**

Numero Fori Flangia	3
Dimensione Fori Flangia	M7×1
Posizione Attacco	113
Diametro Girante	Ø73
N° Alette Girante	8
Posizione Girante	-0.5

**RENAULT**
**4**

1.0	25	06/87 → 12/93	B	C1C708
	31	12/85 → 06/93	B	689710
	25	06/87 → 06/93	B	C1C708
1.1	32	06/86 → 06/90	B	C1E714

81661

350981661000

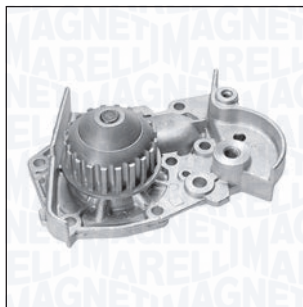

**PULEGGIA**

Diametro Puleggia Ø59.26  
 Numero Denti/Gole Puleggia 20  
 Altezza Puleggia 20.8  
 Posizione Attacco 46.1  
 Diametro Girante Ø60  
 N° Alette Girante 6  
 Posizione Girante 19.5



KW



**RENAULT**

**19 I, Chamade, Cabrio**

1.4	55	09/90 → 04/92	B	E7J700
	57	07/88 → 08/90	B	E6J700, E6J701
	59	01/88 → 12/92	B	E6J700
	59	01/88 → 12/92	B	E6J700, E6J701

**19 II, Chamade, Cabrio**

1.2	44	05/92 → 09/94	B	E7F730
	40	03/92 → 12/95	B	C1G730
1.4	59	03/92 → 12/95	B	E6J700
	59	01/92 → 12/95	B	E6J700, E7J706
	59	10/94 → 11/95	B	E7J706
	55	01/92 → 12/95	B	E7J742

**Clio I**

1.2	40	01/91 → 09/98	B	E7F706
	44	01/91 → 09/98	B	E7F750
	40	01/91 → 06/96	B	E7F706
	43	05/90 → 09/98	B	E7F700, E7F708, E7F750
	44	05/90 → 03/96	B	E5F710
1.4	59	01/91 → 09/98	B	E7J710, E7J711
	55	01/91 → 09/98	B	E7J756, E7J757
	58	01/91 → 09/98	B	E7J601, E7J718, E7J719, E7J754

**Rapid**

1.4	55	09/91 → 03/98	B	E7J720, E7J724, E7J726, E7J773
	58	01/94 → 03/98	B	E7J728

81661

350981661000



KW



**RENAULT**

**Thalia I**

1.2	43	02/98 → 10/03	B	D7F744, D7F746
-----	----	---------------	---	-------------------

81664

350981664000



**FLANGIA**

Numero Fori Flangia 4  
 Dimensione Fori Flangia M8×1.25  
 Posizione Attacco 90  
 Diametro Mozzo Ø23.8  
 Diametro Girante Ø69  
 N° Alette Girante 9  
 Posizione Girante 17.3



KW



**RENAULT**

**Trafic I**

2.1 D	43	05/89 → 06/94	D	852720, 852750	
2.1 D	43	05/89 → 06/94	D	852750	01-1981 →, → 12-1995

81666

350981666000



**FLANGIA**

Numero Fori Flangia 3  
 Dimensione Fori Flangia M8×1.25  
 Posizione Attacco 71  
 Diametro Centraggio Ø51  
 Diametro Girante Ø68  
 N° Alette Girante 8  
 Posizione Girante 17.3



KW



**RENAULT**

**21, Station Wagon**

2.0	78	05/91 → 10/93	B	J6R758	M →: F.197.764
	75	03/86 → 10/93	B	J6R758, J6R759, J6R792, J6R793	M →: F.197.764
	88	09/89 → 12/93	B	J7R746, J7R747	M →: F.197.764
	99	02/90 → 10/92	B	J7R740	M →: F.197.764

**81666 350981666000**

**RENAULT**
**Sierra II, Station Wagon**

2.0 4x4	88	03/89 → 12/93	B	J7R746, J7R747	M →: F.197.764
	99	09/90 → 10/92	B	J7R740	M →: F.197.764
2.2	79	09/89 → 06/94	B	J7T754, J7T755	M →: F241.443
2.2 4x4	79	07/90 → 06/94	B	J7T754, J7T755	M →: F241.443

**25**

2.0	88	03/87 → 12/93	B	J7R722, J7R723	
2.0 12V	103	06/88 → 12/93	B	J7R720, J7R721	
	99	06/89 → 12/92	B	J7R726	
2.2	79	09/86 → 12/92	B	J7T708, J7T732, J7T733	

**Espace II**

2.0	76	01/91 → 10/96	B	J7R768	
2.2	79	01/91 → 10/96	B	J7T772, J7T773, J7T776	
2.2 4x4	79	03/91 → 12/96	B	J7T772, J7T773	

**Master I**

30 2,2	67	08/80 → 07/98	B	J7T782, J7T788	M →: F305.273
--------	----	---------------	---	-------------------	---------------

**Trafic I**

2.0	59	05/89 → 08/90	B	J5R716	01-1981 →, M →: F029.329
2.2	74	06/94 → 10/97	B	J7T600	01-1981 →, M →: F305.273

**81667 350981667000**

**FLANGIA**

Numero Fori Flangia	3
Dimensione Fori Flangia	M8×1.25
Posizione Attacco	67.4
Diametro Mozzo	Ø29.9
Diametro Girante	Ø69
N° Alette Girante	9
Posizione Girante	17.3

**RENAULT**
**Espace II**

2.1 RTDT Quadra	65	01/91 → 05/92	D	J8S772	
2.1 TD	65	01/91 → 10/96	D	J8S610, J8S772, J8S776, J8S778	
	66	11/94 → 10/96	D	J8S612	

**81671 350981671000**

**ALBERINO**

Versione	BC
Diametro Alberino	M14×1.5
Tipo Filetto Alberino	Maschio
Posizione Attacco	134
Diametro Girante	Ø56
N° Alette Girante	6
Posizione Girante	12

**PEUGEOT**
**305 II, Station Wagon**

1.5	50	09/85 → 07/90	B	142 (XR5A)	VF, BC
-----	----	---------------	---	------------	--------

**81672**
**350981672000**

**PULEGGIA**

Diametro Puleggia Ø59.26  
 Numero Denti/Gole Puleggia 20  
 Altezza Puleggia 33.5  
 Posizione Attacco 42.5  
 Diametro Girante Ø69  
 N° Alette Girante 8  
 Posizione Girante 41.3

**CITROËN**
**BX, Break**

1.8 D	44	10/85 → 09/93	D	161 (XUD7)	01-1987 →, PROD →: 3584
1.9 DT TXD	66	02/92 → 12/94	D		
1.9 RD 4x4	52	01/87 → 01/92	D		PROD →: 3584
18 D	44	10/85 → 09/93	D	161A (XUD7)	01-1987 →, PROD →: 3584
19 D	47	09/83 → 09/93	D	162 (XUD9), D9A (XUD9), DJZ (XUD9Y)	01-1987 →, PROD →: 3584
	51	03/87 → 02/93	D	D9B (XUD9A/U)	PROD →: 3584
TRD Turbo	66	03/88 → 02/93	D	A8A (XUD7TE), AJZ (XUD7TE)	
	66	03/88 → 12/94	D	A8A (XUD7TE), AJZ (XUD7TE)	PROD →: 3584

**C 15**

1.8 D	44	07/86 → 12/00	D	161A (XUD7)	PROD →: 3584, → PROD: 6264
-------	----	---------------	---	-------------	-------------------------------

**Xantia I, Break**

1.9 D	50	06/94 → 01/98	D	DJZ (XUD9Y)	→ PROD: 6264
	51	06/94 → 01/98	D	D9B (XUD9A/L)	→ PROD: 6264
1.9 SD	55	02/96 → 01/98	D	DHW (XUD9SD)	→ PROD: 6264
1.9 Turbo D	66	06/95 → 01/98	D	D8B (XUD9TF), DHX (XUD9TF/ BTF), DHY (XUD9TE/Y)	→ PROD: 6264

**81672**
**350981672000**

**CITROËN**
**Xantia I, Break**

1.9 Turbo D	66	10/94 → 01/98	D	DHX (XUD9TF/ BTF), DHY (XUD9TE/Y)	→ PROD: 6264
-------------	----	---------------	---	--------------------------------------	--------------

**ZX, Break**

1.9 D	47	03/91 → 06/97	D	DJZ (XUD9Y)	→ 06-1994, → PROD: 6170
1.9 TD	66	07/92 → 06/97	D	DHY (XUD9TE/Y)	→ 06-1994, → PROD: 6170
	110	06/94 → 06/97	B	RFT (XU10J4/Z)	
2.0 i 16V	112	07/92 → 10/94	B	RFT (XU10J4/Z), RFY (XU10J4/Z)	
	120	05/96 → 06/97	B	RFS (XU10J4RS)	

**FIAT**
**Ulysse I**

1.9 TD	66	02/95 → 08/02	D	DHX (XUD9TF/L)	→ 04-1995
--------	----	---------------	---	----------------	-----------

**LADA**
**Niva I**

1900 Diesel	47	01/93 →	D	XUD9A	
1900 Diesel	55	01/99 →	D	XUD9SD	

**PEUGEOT**
**205 II, Van**

1.7 Diesel	44	07/87 → 09/98	D	161A (XUD7)	
1.8 TD	57	01/90 → 09/98	D	A8B (XUD7TE)	
1.9 Diesel	47	10/87 → 09/98	D	DJZ (XUD9Y)	

**306, Station Wagon, Coupé, Cabrio, Van**

1.8 D	43	05/93 → 05/01	D	A9A (XUD7)	→ PROD: 7390
	47	05/93 → 05/01	D	DJZ (XUD9Y)	→ PROD: 7390
	50	06/94 → 05/01	D	DJY (XUD9A)	→ PROD: 7390
1.9 D	55	03/98 → 05/01	D	DHV (XUD9BSD)	→ PROD: 7390
	66	05/93 → 05/01	D	DHY (XUD9TE)	→ PROD: 7390
1.9 SLD	47	06/94 → 05/01	D	DJZ (XUD9Y)	→ PROD: 7390
	50	06/94 → 05/01	D	DJY (XUD9A)	→ PROD: 7390
1.9 SRDT	66	06/94 → 05/01	D	DHY (XUD9TE)	→ PROD: 7390



**81672 350981672000**

**PEUGEOT**
**306, Station Wagon, Coupé, Cabrio, Van**

1.9 TD	66	02/97 → 04/02	D	DHY (XUD9TE)	→ PROD: 7390
--------	----	---------------	---	--------------	--------------

**309 II**

1.8 Diesel	44	07/89 → 12/93	D	161A(XUD7)
------------	----	---------------	---	------------

1.8 TD	57	08/89 → 12/93	D	A8B (XUD7TE)
--------	----	---------------	---	--------------

1.9 Diesel	47	07/89 → 12/93	D	162 (XUD9), D9A (XUD9), DJZ (XUD9Y)
------------	----	---------------	---	---

**405 I, Station Wagon**

1.8 GLD	44	04/90 → 07/92	D	
---------	----	---------------	---	--

1.8 TD	66	10/88 → 08/92	D	A8A (XUD7TE), AJZ (XUD7TEY)
--------	----	---------------	---	--------------------------------

1.8 Turbo Diesel	66	03/88 → 12/92	D	A8A (XUD7TE), AJZ (XUD7TEY)
------------------	----	---------------	---	--------------------------------

1.9 D	47	10/88 → 08/92	D	DJZ (XUD9Y)	→ 07-1992
-------	----	---------------	---	-------------	-----------

1.9 D	51	10/88 → 08/92	D	D9B (XUD9A), DJY (XUD9A)	→ 07-1992
-------	----	---------------	---	-----------------------------	-----------

1.9 Diesel	47	07/88 → 09/92	D	DJZ (XUD9Y)
	51	03/88 → 12/92	D	D9B (XUD9A)

**J5 II**

1.9 D	51	10/90 → 02/94	D	D9B (XUD9A)
-------	----	---------------	---	-------------

**ROVER**
**200 II, Coupé**

218 D	52	09/91 → 10/95	D	XUD9
-------	----	---------------	---	------

218 TD	65	09/91 → 10/95	D	XUD7TE
--------	----	---------------	---	--------

**400 I, Station Wagon**

1.8 TD	65	09/93 → 11/98	D	XUD7TE
--------	----	---------------	---	--------

418 D	49	09/91 → 04/95	D	XUD9
-------	----	---------------	---	------

418 TD	65	09/91 → 04/95	D	XUD7TE
--------	----	---------------	---	--------

**81681 350981681000**

**PULEGGIA**

Diametro Puleggia	Ø56.3
Numero Denti/Gole Puleggia	19
Altezza Puleggia	20
Posizione Attacco	36.3
Diametro Girante	Ø55
N° Alette Girante	9
Posizione Girante	35

**OPEL**
**Corsa A, Van**

1.4 i	44	01/90 → 03/93	B	C14NZ	→ M: 19.311.737
-------	----	---------------	---	-------	-----------------

1.4 S	53	01/90 → 03/93	B	14NV	→ M: 19.307.806
-------	----	---------------	---	------	-----------------

1.6 GSI	55	08/88 → 09/92	B	C16NZ	→ T: 02J22349
---------	----	---------------	---	-------	---------------

1.6 GSI	72	09/89 → 03/93	B	C16SEI	→ M: 19.311.738
---------	----	---------------	---	--------	-----------------

1.6 GSI	74	05/88 → 03/92	B	E16SE	→ T: 02J22349
---------	----	---------------	---	-------	---------------

**Kadett E, Station Wagon, Coupé, Cabrio, Van**

1.4 i	44	01/90 → 08/91	B	C14NZ	→ M: 19.311.737
-------	----	---------------	---	-------	-----------------

1.4 S	60	09/89 → 08/91	B	C14SE	→ M: 19.311.737
-------	----	---------------	---	-------	-----------------

1.6	60	09/86 → 12/91	B	16SV	→ M: 19.311.737
-----	----	---------------	---	------	-----------------

1.6 i	55	08/91 → 07/94	B	C16NZ	→ M: 19.311.737
-------	----	---------------	---	-------	-----------------

1.6 i	55	09/86 → 08/91	B	E16NZ	→ M: 19.311.737
-------	----	---------------	---	-------	-----------------

1.6 i	60	07/89 → 02/93	B	16SV	→ M: 19.311.737
-------	----	---------------	---	------	-----------------

1.6 i Cat.	55	09/86 → 08/91	B	C16LZ, C16NZ	→ M: 19.311.737
------------	----	---------------	---	-----------------	-----------------

1.6 S	60	09/86 → 08/91	B	16SV	→ M: 19.311.737
-------	----	---------------	---	------	-----------------

**Vectra A**

1.4 S	55	09/88 → 06/92	B	14NV	→ M: 19.307.805
-------	----	---------------	---	------	-----------------

1.6	60	09/88 → 05/93	B	16SV	→ M: 2.122.349
-----	----	---------------	---	------	----------------

1.6 i	52	09/93 → 11/95	B	X16SZ	→ M: 2.122.349
-------	----	---------------	---	-------	----------------

1.6 i	55	09/93 → 11/95	B	16LZ2	→ M: 2.122.349
-------	----	---------------	---	-------	----------------

1.6 i	55	09/88 → 11/95	B	16LZ2, C16LZ2,	→ M: 2.122.349
				C16NZ, C16NZ2, E16NZ	

1.6 i Cat.	55	09/88 → 11/95	B	C16NZ, C16NZ2	→ M: 2.122.349
------------	----	---------------	---	------------------	----------------

1.6 S	60	09/88 → 05/93	B	16SV	→ M: 2.122.349
-------	----	---------------	---	------	----------------

81683

350981683000



**PULEGGIA**

Diametro Puleggia Ø72.5  
 Numero Denti/Gole Puleggia 29  
 Altezza Puleggia 24.5  
 Posizione Attacco 57  
 Diametro Girante Ø72  
 N° Alette Girante 7  
 Posizione Girante 33



KW



**AUDI**

**90 II**

2.0	85	07/88 → 09/91	B	PS	T →: F89-J-394.743
2.0 20 V	118	08/89 → 07/91	B	NM	
2.0 20 V quattro	118	08/88 → 09/91	B	NM	
2.2 E	100	04/87 → 07/91	B	KV	T →: F89-J-394.743
2.2 E quattro	100	04/87 → 09/91	B	KV	T →: F89-J-394.743
2.3 E	98	04/87 → 09/91	B	NG	T →: F89-J-394.743
	100	04/87 → 07/91	B	NG	T →: F89-J-394.743
2.3 E 20V	123	04/90 → 07/91	B	7A	
	125	08/88 → 07/91	B	7A	
2.3 E 20V quattro	123	04/90 → 09/91	B	7A	
	125	06/88 → 09/91	B	7A	
2.3 E quattro	98	04/87 → 09/91	B	NG	T →: F89-J-394.743
	100	04/87 → 07/91	B	NG	T →: F89-J-394.743

**100 III, Avant**

2.0 Cat.	85	01/88 → 11/90	B	RT	M →: 010.236
2.0 E Cat.	85	01/88 → 11/90	B	RT	M →: 010.236
2.2 Cat.	101	06/89 → 11/90	B	HX, KU	
2.2 E Turbo quattro	121	08/86 → 11/90	B	MC	05-1988 →, M →: 039.951
2.2 quattro Cat.	101	06/89 → 11/90	B	HX, KU	
2.2 Turbo	121	08/86 → 11/90	B	MC	05-1988 →, M →: 039.951
2.2 Turbo quattro	121	08/86 → 11/90	B	MC	05-1988 →, M →: 039.951
2.3	98	03/90 → 11/90	B	NF	
	100	08/86 → 11/90	B	NF	05-1988 →, M →: 063.969

81683

350981683000



KW



**AUDI**

**100 III, Avant**

2.3 E	98	01/90 → 11/90	B	NF	
	100	10/86 → 11/90	B	NF	05-1988 →, M →: 063.969
2.3 E quattro	100	08/86 → 11/90	B	NF	05-1988 →, M →: 063.969
2.3 quattro	98	01/90 → 11/90	B	NF	

**200 II, Avant**

2.2 20V Turbo quattro	162	03/89 → 12/90	B	3B	T →: F44-J-246.282
2.2 Turbo	121	08/85 → 09/91	B	MC	M →: 039.951
	140	02/88 → 12/90	B	2B	M →: 001.069
	147	02/88 → 12/90	B	1B	M →: 001.571
2.2 Turbo quattro	121	01/85 → 12/91	B	MC	M →: 039.951
	147	02/88 → 11/90	B	1B	M →: 001.571
2.3	100	11/86 → 09/91	B	NF	

**Coupé II**

1.8	82	08/89 → 07/91	B	DZ	→12-1990, →T: F88-M-033.000
2.0 20 V	118	08/89 → 07/91	B	NM	→T: F88-M-033.000
2.0 20 V quattro	118	08/89 → 07/91	B	NM	→T: F88-M-033.000
2.2 quattro	100	11/88 → 07/91	B	KV	
2.3	98	03/90 → 12/96	B	NG	→12-1990, →T: F88-M-033.000
	100	10/88 → 07/94	B	NG	→12-1990, →T: F88-M-033.000
2.3 20V	123	08/90 → 07/91	B	7A	→12-1990, →T: F88-M-033.000
	125	08/89 → 07/91	B	7A	→12-1990, →T: F88-M-033.000
2.3 20V quattro	123	05/90 → 12/96	B	7A	→12-1990, →T: F88-M-033.000
	125	11/88 → 07/91	B	7A	→12-1990, →T: F88-M-033.000
2.3 quattro	98	05/90 → 12/96	B	NG	→12-1990, →T: F88-M-033.000
	100	11/88 → 12/92	B	NG	→12-1990, →T: F88-M-033.000

**Quattro**

2.2 20V Turbo	162	08/89 → 07/91	B	RR	
---------------	-----	---------------	---	----	--

**81684 350981684000**

	<b>FLANGIA</b>			
	Numero Fori Flangia	4		
	Dimensione Fori Flangia	M6x1		
	Posizione Attacco	70		
	Diametro Mozzo	Ø32		
	Diametro Girante	Ø65		
	N° Alette Girante	6		
	Posizione Girante	5.7		

**OPEL**
**Corsa A, Van**

1.5 D	37	09/87 → 03/93	D	15D (4EC1)	→ M: 804.794
1.5 TD	49	03/88 → 03/93	D	15DT (T4EC1)	→ M: 804.794

**Kadett E, Station Wagon, Coupé, Cabrio, Van**

1.5 TD	53	07/88 → 08/91	D	15DT (T4EC1)	→ M: 804.794
--------	----	---------------	---	--------------	--------------

**81685 350981685000**

	<b>FLANGIA</b>			
	Numero Fori Flangia	4		
	Dimensione Fori Flangia	M6x1		
	Posizione Attacco	70		
	Diametro Mozzo	Ø32		
	Diametro Girante	Ø65		
	N° Alette Girante	6		
	Posizione Girante	5.8		

**OPEL**
**Corsa A, Van**

1.5 D	37	09/87 → 03/93	D	15D (4EC1)	09-1990 →, M →: 910.000
1.5 TD	49	03/88 → 03/93	D	15DT (T4EC1)	09-1990 →, M →: 910.000

**Corsa B, Station Wagon, Van**

1.5 D	37	03/93 → 09/00	D	15D (4EC1)	→ 08-1994, → M: 877.697
1.5 TD	49	03/93 → 09/00	D	15DT (T4EC1), X15DT (T4EC1)	→ M: 877.697

**Kadett E, Station Wagon, Coupé, Cabrio, Van**

1.5 TD	53	07/88 → 08/91	D	15DT (T4EC1)	M →: 804.795
--------	----	---------------	---	--------------	--------------

**81685 350981685000**

**VAUXHALL**
**CORSA**

1.5 D	37	12/92 → 12/96	D	15D	→ M: 877.697
1.5 TD	49	03/93 → 10/96	D	15DT (T4EC1), X15DT (T4EC1)	03-1993 →, → M: 877.697

**81687 350981687000**

	<b>FLANGIA</b>			
	Numero Fori Flangia	4		
	Dimensione Fori Flangia	M6x1		
	Posizione Attacco	70		
	Diametro Mozzo	Ø32		
	Diametro Girante	Ø70		
	N° Alette Girante	6		
	Posizione Girante	7		

**OPEL**
**Astra F, Station Wagon, Cabrio, Van**

1.7 TD	60	03/95 → 02/98	D	X17DT (TC4EE1)	
1.7 TDS	60	03/92 → 09/98	D	17DT (TC4EE1), X17DT (TC4EE1)	→ 12-1992, → M: 855.805

**Astra G, Station Wagon, Coupé, Cabrio, Van**

1.7 TD	50	09/98 → 08/00	D	X17DTL	
--------	----	---------------	---	--------	--

**Combo A**

1.7 D	44	07/94 → 10/01	D	17D (4EE1), X17D (4EE1)	→ M: 877.697
-------	----	---------------	---	----------------------------	--------------

**Corsa A, Van**

1.5 D	37	09/87 → 03/93	D	15D (4EC1)	→ 08-1990, M →: 804.795, → M: 909.999
1.5 TD	49	03/88 → 03/93	D	15DT (T4EC1)	→ 08-1990, M →: 804.795, → M: 909.999

**Corsa B, Station Wagon, Van**

1.7 D	44	02/96 → 09/00	D	17D (4EE1), X17D (4EE1)	→ M: 877.697
-------	----	---------------	---	----------------------------	--------------

**81687**
**350981687000**

**OPEL**
**Vectra A**

1.7 TD	60	03/90 → 11/95	D	17DT (TC4EE1), X17DT (TC4EE1)
--------	----	---------------	---	--

**VAUXHALL**
**CORSA**

1.7 DI 16V	48	08/00 → 09/06	D	Y17DTL
1.7 DTI 16V	55	08/00 → 09/06	D	Y17DT

**81700**
**350981700000**

**AUDI**
**80 V, Avant**

2.3 E	98	09/91 → 12/94	B	NG
2.3 E quattro	98	09/91 → 12/94	B	NG
RS2 quattro	232	03/94 → 05/95	B	ADU
S2 quattro	169	02/93 → 12/94	B	ABY

**100 IV, Avant**

2.3 E	98	12/90 → 06/94	B	AAR
2.3 E quattro	98	12/90 → 06/94	B	AAR
S4 Turbo quattro	169	08/91 → 06/94	B	AAN

**A6 I, Avant**

2.3	98	06/94 → 12/95	B	AAR
2.3 quattro	98	06/94 → 12/95	B	AAR
S6 Turbo quattro	169	06/94 → 10/97	B	AAN

**Cabriolet**

2.3 E	98	05/91 → 07/94	B	NG
-------	----	---------------	---	----

**Coupé II**

1.8	82	08/89 → 07/91	B	DZ	01-1991 →, T →: F88-M-033-001
2.0 20 V	118	08/89 → 07/91	B	NM	T →: F88-M-033.001

**81700**
**350981700000**

**AUDI**
**Coupé II**

2.0 20 V quattro	118	08/89 → 07/91	B	NM	T →: F88-M-033-001
2.3	98	03/90 → 12/96	B	NG	01-1991 →, T →: F88-M-033-001
	100	10/88 → 07/94	B	NG	01-1991 →, T →: F88-M-033-001
2.3 20V	123	08/90 → 07/91	B	7A	01-1991 →, T →: F88-M-033-001
	125	08/89 → 07/91	B	7A	01-1991 →, T →: F88-M-033-001
2.3 20V quattro	123	05/90 → 12/96	B	7A	01-1991 →, T →: F88-M-033-001
	125	11/88 → 07/91	B	7A	01-1991 →, T →: F88-M-033-001
2.3 quattro	98	05/90 → 12/96	B	NG	01-1991 →, T →: F88-M-033-001
	100	11/88 → 12/92	B	NG	01-1991 →, T →: F88-M-033-001
S2 quattro	162	09/90 → 09/92	B	3B	→ T: F88-M-033.000
	169	10/92 → 12/96	B	ABY	

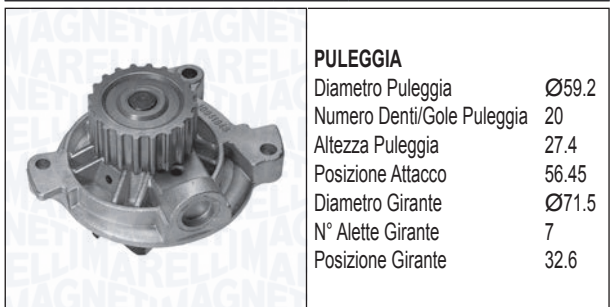
**81701**
**350981701000**

**AUDI**
**100 IV, Avant**

2.4 D	60	12/90 → 06/94	D	AAS
2.5 TDI	85	12/90 → 06/94	D	AAT, ABP

**A6 I, Avant**

2.5 TDI	84	01/95 → 10/97	D	AAT
	85	06/94 → 10/97	D	AAT
	103	08/94 → 10/97	D	AEL
2.5 TDI quattro	103	10/95 → 10/97	D	AEL

**81701 350981701000**

**VOLKSWAGEN**
**LT I 28-35, 40-55**

2.4 TD 70 09/92 → 06/96 D ACL

**LT II 28-35, 28-46**

2.5 SDI 55 07/96 → 07/06 D AGX

61 05/01 → 07/06 D BBE

66 05/99 → 07/06 D APA

2.5 TDI 70 05/01 → 07/06 D BBF

75 05/96 → 08/99 D AHD

80 05/99 → 07/06 D ANJ, AVR

**Transporter IV**

2.4 D 55 08/97 → 04/03 D AJA

57 09/90 → 04/98 D AAB 08-1995 →, T →: F70.N.014.001

2.4 D Syncro 57 10/92 → 09/98 D AAB 08-1995 →, T →: F70.N.014.001

2.5 81 11/90 → 04/03 B AAF, ACU, AEN, AEU T →: F70.N.014.001, M: AEN, M: AEU, M: AEN

85 08/96 → 04/03 B AET, APL, AVT

2.5 Syncro 81 10/92 → 04/03 B AAF, ACU, AEN, AEU T →: F70.N.014.001, M: AEN, M: AEU, M: AEN

81 11/92 → 04/03 B AAF, ACU, AEN, AEU T →: F70.N.014.001, M: AEU, M: AEN, M: AEU

85 07/96 → 04/03 B AET, APL, AVT

65 05/98 → 04/03 D AJT, AYY

2.5 TDI 75 09/95 → 04/03 D ACV, AUF, AXL, AYC

75 09/95 → 04/03 D ACV, AUF, AYC

111 05/98 → 04/03 D AHY, AXG

111 09/00 → 04/03 D AXG

2.5 TDI Syncro 75 01/96 → 04/03 D ACV, AXL

**81701 350981701000**

**VOLVO**
**850, Station Wagon**

2.5 TDI 103 08/95 → 12/96 D D5252T

**940 I, Station Wagon**

2.4 TD Intercooler 90 08/90 → 12/94 D D24TIC 07-1992 →, T →: 30.004

**940 II, Station Wagon**

2.4 TD Interc. 90 08/94 → 10/98 D D24TIC

**960 I, Station Wagon**

2.4 TD Interc. 85 09/91 → 07/94 D D24TIC 07-1992 →, T →: 30.004

**S 70**

2.5 TDI 103 01/97 → 11/00 D D5252T

**S 80 I**

2.5 TDI 103 01/99 → 07/06 D D5252T → 12-2002

**V 70 I**

2.5 TDI 103 01/97 → 05/00 D D5252T

**81702 350981702000**

**AUDI**
**A3 I**

1.6 74 09/96 → 05/03 B AEH, AKL, APF

75 08/00 → 05/03 B AVU, BFQ

**A3 II, Sportback, Cabriolet**

1.6 75 05/03 → 08/12 B BGU, BSE, BSF, CCSA, CMXA

75 09/08 → 05/10 B BSE

1.6 E-Power 75 01/11 → 08/12 FF CCSA, CMXA

1.8 T 110 08/06 → 08/12 B BPU

2.0 FSI 110 05/03 → 06/08 B AXW, BLR, BLX, BLY, BMB, BVY, BVZ

**81702**
**350981702000**

**AUDI**
**A4 I, Avant**

1.6	74	11/94 → 10/00	B	ADP, AHL, ANA, ARM	12-1997 →, → 07-2000, M: AHL/ANA/ARM
	75	07/00 → 11/00	B	ALZ	

**A4 II, Avant, Cabriolet**

1.6	75	11/00 → 12/04	B	ALZ	
2.0	96	09/04 → 12/05	B	ALT	M: ALT
	96	11/00 → 12/04	B	ALT	
2.0 FSI	110	07/02 → 12/04	B	AWA	

**A4 III, Avant**

1.6	75	11/04 → 06/08	B	ALZ	
2.0	96	11/04 → 06/08	B	ALT	

**A6 II, Avant**

1.8	92	07/97 → 01/05	B	AJP, ANQ, AQE, ARH	
	92	12/97 → 01/05	B	AJP, AQE, ARH	
2.0	96	08/01 → 01/05	B	ALT	

**SEAT**
**Altea, Altea XL**

1.6	75	03/04 →	B	BGU, BSE, BSF, CCSA, CMXA	
	75	10/06 →	B	BSE, BSF, CCSA, CMXA	
1.6 LPG	75	09/09 →		CHGA	
1.6 Multifuel	75	10/06 →		CCSA	
2.0 FSI	110	05/04 → 03/09	B	BLR, BLY, BVY, BVZ	
2.0 FSI	110	10/06 → 03/09	B	BVY, BVZ	

**Cordoba II, Vario**

1.6	74	06/99 → 10/02	B	AEH, AKL, APF, AUR	
-----	----	---------------	---	-----------------------	--

**Exeo, Exeo ST**

1.6	75	03/09 → 09/10	B	ALZ	
1.8 T	110	12/08 → 05/10	B	CFMA	

**Ibiza III**

1.6	74	08/99 → 02/02	B	AEH, AKL, APF, AUR	
-----	----	---------------	---	-----------------------	--

**Leon I**

1.6	74	11/99 → 06/06	B	AEH, AKL, APF	
	75	10/05 → 06/06	B	BFQ, BGU	

**81702**
**350981702000**

**SEAT**
**Leon II**

1.6	75	07/05 → 12/12	B	BSE, BSF, CCSA, CMXA	
1.6 LPG	75	12/09 → 12/12		CHGA	
1.6 MultiFuel	75	11/10 → 12/12		BSE, CMXA	
2.0 FSI	110	07/05 → 05/10	B	BLR, BLY, BVY, BVZ	

**Toledo II**

1.6	74	10/98 → 07/04	B	AEH, AKL, APF	08-1995 →
-----	----	---------------	---	------------------	-----------

**Toledo III**

1.6	75	10/04 → 05/09	B	BGU, BSE, BSF, CCSA	
2.0 FSI	110	10/04 → 05/09	B	BLR, BLY, BVY, BVZ	

**SKODA**
**Octavia I, Station Wagon**

1.6	74	02/97 → 12/07	B	AEH, AKL	
	74	07/98 → 12/07	B	AEH, AKL	
	75	11/00 → 12/10	B	AVU, BFQ	

**Octavia II, Station Wagon**

1.6	75	06/04 → 06/13	B	BGU, BSE, BSF, CCSA, CMXA	
1.6 LPG	75	08/09 → 11/12		CHGA	
1.6 MultiFuel	75	01/08 → 06/13		CCSA, CMXA	
2.0 FSI	110	11/04 → 10/08	B	BLR, BLY, BVY, BVZ	
2.0 FSI 4x4	110	11/04 → 10/08	B	BLX, BVX	

**VOLKSWAGEN**
**Bora, Station Wagon**

1.6	74	10/98 → 05/05	B	AEH, AKL, APF	
	75	08/00 → 05/05	B	AVU, BFQ	
	75	08/00 → 05/05	B	AVU, BFQ, BJH	
	78	06/02 → 10/04	B	AWB	

**Caddy III**

1.6	74	03/05 →	B	BRY	
	75	04/04 →	B	BGU, BSE, BSF	
	1.6 BiFuel	75	05/11 →	BF	CHGA

**81702 350981702000**

**VOLKSWAGEN**
**Eos**

2.0 FSI 110 03/06 → 05/08 B BVY, BVZ

**Golf IV, Variant, Cabrio**

1.6	74	08/97 → 05/04	B	AEH, AKL, APF
	75	08/00 → 06/06	B	AVU, BFQ
	75	08/00 → 06/05	B	AVU, BFQ, BJH
	74	02/01 → 06/01	B	BAH

**Golf V, Plus, Variant**

1.6	75	01/04 → 11/08	B	BGU, BSE, BSF
	75	06/07 → 07/09	B	BGU, BSE, BSF, CCSA
	75	05/05 → 12/13	B	BSE, BSF, CCSA, CMXA
1.6 BiFuel	75	05/09 → 12/13	BF	CHGA
1.6 MultiFuel	75	10/07 → 11/08		CCSA
	75	11/07 → 12/13		CCSA, CMXA

2.0 FSI	110	01/04 → 11/08	B	AXW, BLR, BLX, BLY, BVX, BVY, BVZ
	110	05/05 → 06/08	B	BLR, BLY, BVY, BVZ

2.0 FSI 4motion	110	08/04 → 11/08	B	BLX, BLY, BVX, BVY, BVZ
-----------------	-----	---------------	---	-------------------------

**Golf VI, Variant, Cabrio**

1.6	75	10/08 → 11/12	B	BSE, BSF, CCSA, CMXA
1.6 BiFuel	75	03/09 → 11/12	BF	CHGA
1.6 MultiFuel	75	10/08 → 11/12		CCSA, CMXA
	75	07/10 → 07/13		CMXA

**Jetta III**

1.6	75	10/05 → 10/10	B	BGU, BSE, BSF, CCSA
1.6 MultiFuel	75	01/08 → 10/10		CCSA

**81702 350981702000**

**VOLKSWAGEN**
**Jetta III**

2.0 FSI 110 08/05 → 10/10 B BLR, BLX, BLY, BVY, BVZ

**New Beetle, Cabrio**

1.6	74	10/99 → 09/00	B	AWH
	75	06/00 → 09/10	B	AYD, BFS
	75	01/03 → 09/10	B	BFS

**Passat IV, Variant**

1.6	74	10/96 → 11/00	B	ADP, AHL, ANA, ARM	01-1998 →, M: ARM, M: ANA, M: ARM, M: AHL, M: ANA
	74	06/97 → 11/00	B	ADP, AHL, ANA, ARM	01-1998 →, M: AHL, M: ANA, M: AHL, M: ARM, M: ANA

1.8 T	110	10/96 → 11/00	B	AEB, ANB, APU	M: APU
-------	-----	---------------	---	---------------	--------

**Passat V, Variant**

1.6	75	11/00 → 05/05	B	ALZ
2.0	96	11/01 → 05/05	B	ALT

**Passat VI, Variant, CC**

1.6	75	05/05 → 07/10	B	BSE, BSF
2.0 FSI	110	03/05 → 07/10	B	BLR, BLY, BVY, BVZ
2.0 FSI 4motion	110	09/05 → 07/10	B	BLX, BLY, BVX

**Polo III (6N1), Classic, Variant, Van**

1.6	74	05/97 → 09/01	B	AEH, AFT, AKL, APF, AUR	M: AUR, M: AKL, M: AEH, M: AUR, M: APF, M: AKL
100 1.6	74	12/95 → 09/01	B	AEH, AFT, AKL, APF, AUR	

**Touran I**

1.6	75	07/03 → 05/10	B	BGU, BSE, BSF
2.0 FSI	85	10/04 → 05/10	B	BJZ
2.0 FSI	110	10/03 → 01/07	B	AXW, BLR, BLX, BLY, BVY, BVZ

**81703**
**350981703000**

**PULEGGIA**

Diametro Puleggia Ø57.19  
 Numero Denti/Gole Puleggia 23  
 Altezza Puleggia 26.5  
 Posizione Attacco 45.7  
 Diametro Girante Ø60.1  
 N° Alette Girante 8  
 Posizione Girante 48

**KW**

**AUDI**
**A3 I**

1.8	92	09/96 → 05/03	B	AGN, APG	
1.8 T	110	12/96 → 05/03	B	AGU, AQA, ARZ, AUM	
	132	12/98 → 05/03	B	AJQ, APP, ARY, AUQ	
1.8 T quattro	110	12/96 → 05/03	B	AGU, AQA, ARX	
	132	10/98 → 05/03	B	AJQ, ARY	
S3 quattro	154	03/99 → 04/02	B	AMK, APY, AUL	
	165	10/01 → 05/03	B	BAM	

**A4 II, Avant, Cabriolet**

1.8 T	110	11/00 → 07/02	B	AVJ	
	120	07/02 → 12/04	B	BFB	
	120	07/02 → 12/04	B	BFB, BKB	
	125	07/01 → 12/04	B	AMB	
1.8 T quattro	140	11/02 → 12/04	B	BEX	
	110	11/00 → 07/02	B	AVJ	
	120	07/02 → 12/04	B	BFB	
	125	07/01 → 12/04	B	AMB	
	140	11/02 → 12/04	B	BEX	

**A4 III, Avant**

1.8 T	120	11/04 → 06/08	B	BFB	
1.8 T quattro	120	11/04 → 06/08	B	BFB	

**A6 II, Avant**

1.8 T	110	01/97 → 01/05	B	AEB, ANB, APU, ARK, AWL, AWT	05-2000 →, → 07-2004, M: AWT
	110	12/97 → 01/05	B	AEB, ANB, APU, ARK, AWT	02-2000 →, → 07-2004, M: AWT
1.8 T quattro	110	02/97 → 01/05	B	AEB, ANB, APU, ARK, AWT	05-2000 →, → 07-2004, M: AWT

**81703**
**350981703000**

**KW**

**AUDI**
**TT I, Roadster**

1.8 T	110	09/02 → 06/06	B	AUM	
	120	09/05 → 06/06	B	BVP	
	132	10/99 → 06/06	B	AJQ, APP, ATC, AUQ	
	132	10/98 → 06/06	B	AJQ, APP, ATC, AUQ, AWP	
	140	09/05 → 06/06	B	BVR	
1.8 T quattro	132	10/98 → 06/06	B	AJQ, ARY, AUQ, AWP	
	140	09/05 → 06/06	B	BVR	
	165	10/98 → 06/06	B	APX, BAM	
	176	03/05 → 06/06	B	BFV	

**SEAT**
**Alhambra I**

1.8 T 20V	110	10/97 → 03/10	B	AJH, AWC	
2.0 i	85	04/96 → 03/10	B	ADY, ATM	08-2000 →, M: ATM

**Cordoba II, Vario**

1.8 T 20V Cupra	115	07/00 → 10/02	B	AQX, AYP	
-----------------	-----	---------------	---	----------	--

**Cordoba III, Vario**

2.0	85	09/02 → 11/09	B	AZL, BBX	
-----	----	---------------	---	----------	--

**Ibiza III**

1.8 T 20V Cupra	115	07/00 → 02/02	B	AQX, AYP	
-----------------	-----	---------------	---	----------	--

**Ibiza IV**

1.8 T Cupra R	132	01/04 → 02/08	B	BBU, BLZ	
1.8 T FR	110	12/03 → 05/08	B	BJX, BKV	
2.0	85	04/02 → 11/09	B	AZL, BBX	

**Ibiza V**

2.0	85	10/08 →	B	CEKA	
-----	----	---------	---	------	--

**Leon I**

1.8 20V	92	11/99 → 06/06	B	AGN, APG	
1.8 20V T	132	11/99 → 06/06	B	APP, AUQ	
1.8 20V T 4	132	11/99 → 06/06	B	AJQ, ARY	
1.8 T Cupra R	154	02/02 → 06/06	B	AMK	
	165	07/03 → 06/06	B	BAM	

**Toledo II**

1.8 20V	92	10/98 → 07/04	B	AGN, APG	
1.8 20VT	132	09/00 → 07/04	B	APP, AUQ	



**81703 350981703000**

**SKODA**
**Fabia I, Station Wagon, Van**

2.0	85	12/99 → 03/08	B	AZL
-----	----	---------------	---	-----

**Octavia I, Station Wagon**

1.8	92	09/96 → 07/00	B	AGN
-----	----	---------------	---	-----

1.8 20V	92	07/98 → 07/00	B	AGN
---------	----	---------------	---	-----

1.8 T	110	08/97 → 12/10	B	AGU, ARX, ARZ, AUM
-------	-----	---------------	---	--------------------

	110	07/98 → 12/10	B	AGU, ARX, ARZ, AUM
--	-----	---------------	---	--------------------

1.8 T 4x4	110	05/01 → 05/06	B	AGU, ARX, AUM
-----------	-----	---------------	---	---------------

	110	05/01 → 05/06	B	ARX, AUM
--	-----	---------------	---	----------

2.0	85	04/99 → 05/07	B	AEG, APK, AQY, AZH, AZJ
-----	----	---------------	---	-------------------------

	85	04/99 → 05/07	B	AEG, APK, AQY, AZH, AZJ
--	----	---------------	---	-------------------------

2.0 4x4	85	08/00 → 09/04	B	AZH, AZJ
---------	----	---------------	---	----------

	88	01/00 → 12/10	B	ATF
--	----	---------------	---	-----

RS 1.8 T	132	05/01 → 01/06	B	AUQ
----------	-----	---------------	---	-----

**Superb I**

1.8 T	110	12/01 → 03/08	B	AWT
-------	-----	---------------	---	-----

2.0	85	12/01 → 03/08	B	AZM
-----	----	---------------	---	-----

**VOLKSWAGEN**
**Bora, Station Wagon**

1.8	92	10/98 → 05/05	B	AGN, BAF
-----	----	---------------	---	----------

1.8 4motion	92	02/99 → 05/05	B	AGN
-------------	----	---------------	---	-----

1.8 T	110	05/00 → 05/05	B	AGU, ARX, AUM
-------	-----	---------------	---	---------------

	110	05/00 → 05/05	B	AGU, ARX, AUM, BAE
--	-----	---------------	---	--------------------

	132	03/02 → 05/05	B	AUQ
--	-----	---------------	---	-----

2.0	85	05/99 → 05/05	B	APK, AQY, AZG, AZH, AZJ
-----	----	---------------	---	-------------------------

	85	10/98 → 05/05	B	APK, AQY, AZG, AZH, AZJ, BBW
--	----	---------------	---	------------------------------

2.0 4motion	85	04/00 → 05/05	B	AZH, AZJ
-------------	----	---------------	---	----------

**Caddy III**

2.0 EcoFuel	80	04/06 →	M	BSX
-------------	----	---------	---	-----

**81703 350981703000**

**VOLKSWAGEN**
**Golf IV, Variant, Cabrio**

1.8	92	08/97 → 06/05	B	AGN, BAF	10-1997 →
-----	----	---------------	---	----------	-----------

1.8 4motion	92	05/98 → 06/05	B	AGN	
-------------	----	---------------	---	-----	--

1.8 T	110	08/97 → 06/05	B	AGU, AQA, ARZ, AUM, AWD	10-1997 →
-------	-----	---------------	---	-------------------------	-----------

	110	05/00 → 06/06	B	AGU, AQA, ARZ, AUM, AWD	
--	-----	---------------	---	-------------------------	--

1.8 T GTI	132	08/01 → 06/05	B	AUQ	
-----------	-----	---------------	---	-----	--

2.0	85	07/98 → 05/04	B	APK, AQY, AZG, AZJ, BER	
-----	----	---------------	---	-------------------------	--

	85	05/99 → 06/06	B	APK, AQY, AZJ	
--	----	---------------	---	---------------	--

2.0 4motion	85	10/00 → 06/05	B	AZH, AZJ	
-------------	----	---------------	---	----------	--

	88	12/99 → 06/06	B	ATF	
--	----	---------------	---	-----	--

2.0 Bi-Fuel	85	02/02 → 06/06		BEH	
-------------	----	---------------	--	-----	--

**Multivan V**

2.0	85	11/03 →	B	AXA	
-----	----	---------	---	-----	--

**New Beetle, Cabrio**

1.8 T	110	10/99 → 09/10	B	AGU, APH, AVC, AWU, AWV, BKF	
-------	-----	---------------	---	------------------------------	--

	110	01/03 → 09/10	B	AWU, AWV, BKF	
--	-----	---------------	---	---------------	--

	132	11/01 → 06/05	B	AWP, BNU	
--	-----	---------------	---	----------	--

2.0	85	01/98 → 09/10	B	AEG, APK, AQY, AVH, AZG, AZJ, BEJ, BER, BEV, BHP, CBPA	
-----	----	---------------	---	--	--

	85	09/02 → 10/10	B	AQY, AZJ, BDC, BEV, BGD	
--	----	---------------	---	-------------------------	--

**Passat IV, Variant**

2.0	88	04/00 → 11/00	B	ASU, AUZ	
-----	----	---------------	---	----------	--

2.0 4motion	88	04/00 → 11/00	B	ASU	
-------------	----	---------------	---	-----	--

2.0 4motion	88	04/00 → 11/00	B	ASU, AUZ	
-------------	----	---------------	---	----------	--

**Passat V, Variant**

1.8 T	125	02/01 → 05/05	B	AWM	
-------	-----	---------------	---	-----	--

1.8 T 20V	110	11/00 → 05/05	B	AWL, AWT	
-----------	-----	---------------	---	----------	--

	110	11/00 → 05/05	B	AWT	
--	-----	---------------	---	-----	--

1.8 T 4motion	125	03/01 → 05/05	B	AWM	
---------------	-----	---------------	---	-----	--

**81703 350981703000**



**VOLKSWAGEN**

**Passat V, Variant**

2.0	85	11/00 → 05/05	B	AZM	
	85	11/00 → 05/05	B	AZM, BFF	
2.0 4motion	85	11/00 → 05/05	B	AZM	

**Polo V (9N)**

1.8 GTI	110	09/05 → 11/09	B	BJX	
1.8 GTI Cup Edition	132	05/06 → 11/09	B	BBU	

**Sharan I**

1.8 T 20V	110	09/97 → 03/10	B	AJH, AWC	
2.0	85	09/95 → 03/10	B	ADY, ATM	03-2000 →, M: ATM
2.0 LPG	85	04/06 → 03/10		ATM	

**Touran I**

2.0 EcoFuel	80	02/06 → 05/09	M	BSX	
-------------	----	---------------	---	-----	--

**Transporter V**

2.0	85	11/03 →	B	AXA	
-----	----	---------	---	-----	--

**81705 350981705000**



**PULEGGIA**

Diametro Puleggia Ø57.1

Altezza Puleggia 33

Posizione Attacco 61

Diametro Girante Ø79

N° Alette Girante 5

Posizione Girante 29.4



**AUDI**

**A4 I, Avant**

2.5 TDI	110	09/97 → 11/00	D	AFB, AKN	
2.5 TDI quattro	110	09/97 → 11/00	D	AFB, AKN	

**A4 II, Avant, Cabriolet**

2.5 TDI	114	08/01 → 07/02	D	AYM	
	120	07/02 → 12/04	D	BCZ, BDG, BFC	
	132	10/00 → 05/03	D	AKE	
2.5 TDI quattro	132	11/00 → 12/04	D	AKE, BAU, BDH	

**A4 III, Avant**

2.5 TDI	120	11/04 → 05/06	D	BDG	
---------	-----	---------------	---	-----	--

**81705 350981705000**



**AUDI**

**A6 II, Avant**

2.5 TDI	110	07/97 → 01/05	D	AFB, AKN	
	114	08/01 → 01/05	D	AYM	
	120	07/02 → 01/05	D	BCZ, BDG, BFC	
	132	02/00 → 01/05	D	AKE, BAU, BDH	
	132	02/00 → 01/05	D	AKE, BAU, BDH, BND	
2.5 TDI quattro	110	07/97 → 01/05	D	AFB, AKN	
	132	02/00 → 01/05	D	AKE, BAU, BDH	

**A8 I**

2.5 TDI	110	01/97 → 04/00	D	AFB, AKN	
	132	09/00 → 09/02	D	AKE	
2.5 TDI quattro	110	07/97 → 04/00	D	AFB, AKN	
	132	09/00 → 09/02	D	AKE	

**Allroad**

2.5 TDI quattro	120	05/03 → 08/05	D	BCZ	
	132	05/00 → 08/05	D	AKE, BAU	

**SKODA**

**Superb I**

2.5 TDI	114	12/01 → 08/03	D	AYM	
2.5 TDI	120	06/03 → 03/08	D	BDG	

**VOLKSWAGEN**

**Passat IV, Variant**

2.5 TDI	110	07/98 → 11/00	D	AFB, AKN	
2.5 TDI Syncro/4motion	110	12/98 → 11/00	D	AFB, AKN	

**Passat V, Variant**

2.5 TDI	110	11/00 → 05/05	D	AFB, AKN	
2.5 TDI	120	05/03 → 05/05	D	BDG	
2.5 TDI 4motion	110	11/00 → 05/05	D	AFB, AKN	
	132	01/03 → 05/05	D	BAU, BDH	

**81706**
**350981706000**

**PULEGGIA**

Diametro Puleggia	Ø56.1
Numero Denti/Gole Puleggia	19
Altezza Puleggia	28.5
Posizione Attacco	47.2
Diametro Girante	Ø63.8
N° Alette Girante	8
Posizione Girante	46

**KW**

**AUDI**
**A3 I**

1.9 TDI	66	09/96 → 07/01	D	AGR, ALH	T →: F8L-V-115.001
	81	08/97 → 07/01	D	AHF, ASV	T →: F8L-V-115.001

**SEAT**
**Cordoba II, Vario**

1.9 SDI	50	06/99 → 10/02	D	AGP, AQM	
1.9 TDI	66	06/99 → 10/02	D	AGR, AHU, ALH	
	66	06/99 → 12/02	D	AGR, ALH	
	81	06/99 → 10/02	D	ASK, ASV	

**Ibiza III**

1.9 SDI	50	08/99 → 02/02	D	AGP, AQM	
1.9 TDI	66	08/99 → 02/02	D	AGR, ALH	
	81	08/99 → 02/02	D	ASK, ASV	

**Inca**

1.9 TDI	66	09/96 → 06/03	D	ALH	11-1995 →
---------	----	---------------	---	-----	-----------

**Leon I**

1.9 SDI	50	11/99 → 06/06	D	AQM	
1.9 TDI	66	11/99 → 06/06	D	AGR, ALH	
	81	11/99 → 06/06	D	AHF, ASV	

**Toledo II**

1.9 SDI	50	11/99 → 06/04	D	AQM	
1.9 TDI	66	03/99 → 07/04	D	AGR, ALH	05-1991 →
	81	10/98 → 07/04	D	AHF, ASV	05-1991 →

**SKODA**
**Octavia I, Station Wagon**

1.9 SDI	50	06/97 → 12/03	D	AGP, AQM	
1.9 TDI	66	09/96 → 03/10	D	AGR, ALH	
	66	07/98 → 03/10	D	AGR, ALH	
	81	08/97 → 01/06	D	AHF, ASV	
1.9 TDI 4x4	66	11/99 → 02/06	D	AGR	

**81706**
**350981706000**

**KW**

**VOLKSWAGEN**
**Bora, Station Wagon**

1.9 SDI	50	10/98 → 05/05	D	AGP, AQM	
1.9 TDI	66	10/98 → 05/05	D	AGR, ALH	
	81	10/98 → 06/01	D	AHF, ASV	
1.9 TDI 4motion	66	11/98 → 04/02	D	AGR	

**Caddy II**

1.9 SDI	47	11/95 → 01/04	D	AEY, AYQ	M: AYQ
---------	----	---------------	---	----------	--------

**Golf IV, Variant, Cabrio**

1.9 SDI	50	08/97 → 06/05	D	AGP, AQM	M: AQM, M: AGP
1.9 TDI	66	10/97 → 05/04	D	AGR, ALH	M: ALH, M: AGR
	81	08/97 → 05/04	D	AHF, ASV	M: ASF, M: AHF
	81	05/99 → 06/01	D	AHF, ASV	M: ASV, M: AHF
1.9 TDI 4motion	66	07/98 → 04/02	D	AGR, ALH	M: ALH, M: AGR

**New Beetle, Cabrio**

1.9 TDI	66	01/98 → 06/04	D	ALH	
---------	----	---------------	---	-----	--

**Polo III (6N1), Classic, Variant, Van**

1.9 SDI	50	08/99 → 09/01	D	AGP, AQM	
1.9 TDI	66	05/97 → 09/01	D	AGR, AHU, ALE, ALH	M: ALH, M: AGR
	81	06/98 → 09/01	D	AFN, ASV	M: ASV
68 1.9 SDI	50	08/99 → 01/02	D	AGP, AQM	
90 1.9 TDI	66	09/96 → 09/01	D	AGR, AHU, ALE, ALH	M: ALH, M: AGR

**81707**
**350981707000**

**FLANGIA**

Posizione Attacco	65
Diametro Mozzo	Ø28
Diametro Girante	Ø85.5
N° Alette Girante	6
Posizione Girante	0

**KW**

**HONDA**
**Accord V, Aerodeck, Coupé**

2.0 TDi	77	04/96 → 10/98	D	20T2N	
---------	----	---------------	---	-------	--

**Accord VI, Aerodeck, Hatchback, Coupé**

2.0 TDi	77	12/99 → 10/00	D	20T2N	
2.0 Turbo DI	77	02/99 → 12/02	D	20T2N	

**81707 350981707000**



**HONDA**

**Civic VI, Hatchback, Aerodeck, Fastback, Coupé**

2.0 i D	77	04/98 → 02/01	D	20T2N	
2.0 i TD	63	01/97 → 02/01	D	20T2R	
2.0 TDiC	77	11/98 → 10/00	D	20T2N	
	74	11/98 → 10/00	D	20T2N	

**LAND ROVER**

**Discovery I**

2.0 16 V 4x4	99	06/89 → 10/98	B	20T4H	
--------------	----	---------------	---	-------	--

**Freelander I**

2.0 DI 4x4	72	02/98 → 11/00	D	20T2N	
------------	----	---------------	---	-------	--

**MG**

**MG ZR**

2.0 TD	74	06/01 → 04/05	D	20T2N	
--------	----	---------------	---	-------	--

**MG ZS**

2.0 TD	74	01/04 → 04/05	D	20T2N	
	83	01/04 → 04/05	D	20T2N	

**ROVER**

**25**

2.0 iDT	74	10/99 → 05/05	D	20T2N	
---------	----	---------------	---	-------	--

**45**

2.0 iDT	74	02/00 → 05/05	D	20T2N	
---------	----	---------------	---	-------	--

**200 II, Coupé**

2.0	152	10/92 → 09/97	B		
-----	-----	---------------	---	--	--

220 GSi	100	05/94 → 06/99	B	20T4H	
---------	-----	---------------	---	-------	--

220 GTi	100	01/93 → 10/95	B	20T4H	
	103	09/91 → 10/95	B	20M4F	

220 Turbo	147	01/93 → 10/95	B	20T4G	
-----------	-----	---------------	---	-------	--

**200 III**

220 D/SD	63	11/95 → 03/00	D	20T2R	
----------	----	---------------	---	-------	--

220 SDi	77	11/95 → 03/00	D	20T2N	
---------	----	---------------	---	-------	--

**400 I, Station Wagon**

2.0 i	100	05/94 → 11/98	B	20T4H	
-------	-----	---------------	---	-------	--

2.0 Turbo GSi Sport	152	10/92 → 04/95	B		
---------------------	-----	---------------	---	--	--

420 GSi/SLI/ GTI/Vite	100	01/93 → 04/95	B	20T4H	
-----------------------	-----	---------------	---	-------	--

420 GTI/ GSi/Vitesse	103	02/92 → 04/95	B	20M4F	10-1992 →
----------------------	-----	---------------	---	-------	-----------

420 Turbo	147	01/93 → 04/95	B	20T4G	
-----------	-----	---------------	---	-------	--

**400 II**

420 D	63	11/95 → 03/00	D	20T2R	
-------	----	---------------	---	-------	--

420 Di	77	05/95 → 03/00	D	20T2N	
--------	----	---------------	---	-------	--

420 Si Lux	100	12/95 → 03/00	B	20T4H	
------------	-----	---------------	---	-------	--

**81707 350981707000**



**HONDA**

**600**

620 Sdi	77	12/94 → 02/99	D	20T2N	
---------	----	---------------	---	-------	--

620 Ti Vitesse	147	07/94 → 02/99	B	20T4G	
----------------	-----	---------------	---	-------	--

**800**

820 16V Turbo	132	01/92 → 02/99	B	T16	
---------------	-----	---------------	---	-----	--

820 I/Si	100	01/92 → 02/99	B	20T4H	
----------	-----	---------------	---	-------	--

820 Sport	145	04/94 → 03/96	B	20T4G	
-----------	-----	---------------	---	-------	--

**Streetwise**

2.0 TD	74	08/03 → 05/05	D	20T2N	
--------	----	---------------	---	-------	--

**81708 350981708000**

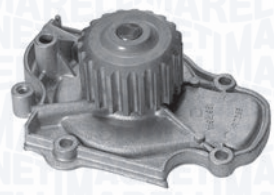

**PULEGGIA**

Diametro Puleggia Ø59.26

Numero Denti/Gole Puleggia 20

Altezza Puleggia 28.5

Posizione Attacco 56

Diametro Girante Ø56.5

N° Alette Girante 7

Posizione Girante 20.3



**ACURA**

**CL**

2.2	108	10/96 → 09/97	B	F22B2	
-----	-----	---------------	---	-------	--

2.3 Vtec	112	10/98 → 09/00	B	F23A7	
----------	-----	---------------	---	-------	--

**HONDA**

**Accord IV, Aerodeck, Coupé**

2.0 16V	66	01/90 → 03/93	B	F20A6	
	81	01/90 → 03/93	B	F20A2, F20A3	

2.0 i 16V	98	01/90 → 03/93	B	F20A4, F20A8	
	98	01/92 → 09/93	B	F20A7	
	98	03/93 → 12/93	B	F20Z3	

2.0 i 16V	108	01/91 → 12/93	B	F22A8	
	110	01/90 → 03/93	B	F22A3	
	110	01/91 → 12/93	B	F22A7	

2.2 i 16V Automatic	108	01/90 → 03/93	B	F22A3	
---------------------	-----	---------------	---	-------	--

**81708 350981708000**

**HONDA**
**Accord V, Aerodeck, Coupé**

1.9 i	85	02/96 → 10/98	B	F18A3
2.0	100	09/93 → 12/97	B	F20B3
2.0 i	85	03/93 → 01/96	B	F20Z2
2.0 iLS	96	02/96 → 10/98	B	F20Z1
2.0 iLS 16V	100	09/93 → 02/98	B	F20B3
2.0 iS	96	03/93 → 01/96	B	F20Z1
2.2 i ES	110	09/93 → 02/98	B	F22B5
2.2 i VTEC	110	02/96 → 10/98	B	F22Z2

**Accord VI, Aerodeck, Hatchback, Coupé**

2.0	108	12/99 → 12/02	B	F20B6
2.0 i	108	10/98 → 01/01	B	F20B6
2.0 i 16V	108	02/98 → 06/03	B	F20B5, F20B7
2.3	113	01/01 → 06/03	B	F23A1, F23Z5
	113	11/00 → 12/02	B	F23Z5
2.3 16 V	118	02/98 →	B	F23A7
2.3 VTi	113	02/98 → 10/02	B	F23A3
2.0	114	02/03 → 05/08	B	K20A6
	114	04/03 → 05/08	B	K20A6
2.0 Trazione integrale	114	02/03 → 05/08	B	K20A6

**Prelude IV**

2.0 i 16V	98	02/92 → 09/96	B	F20A4
2.2 i 16V Vtec	136	02/93 → 09/96	B	H22A2

**Prelude V**

2.0 16V	98	10/96 → 10/00	B	F20A4
2.2 16V	147	10/96 → 10/00	B	H22A5
	136	10/96 → 10/00	B	H22A2, H22A5

**Shuttle**

2.2 16V	110	10/94 → 02/98	B	F22B8
2.2 4x4	102	06/94 → 09/97	B	F22B9
2.3 16V	110	10/97 → 06/04	B	F23A7
2.3 16V 4x4	110	10/97 → 06/02	B	F23A

**ROVER**
**600**

618 i/Si	85	03/96 → 02/99	B	F18A3
620 i	85	08/93 → 06/96	B	F20Z2
620 Si	96	08/93 → 02/99	B	F20Z1

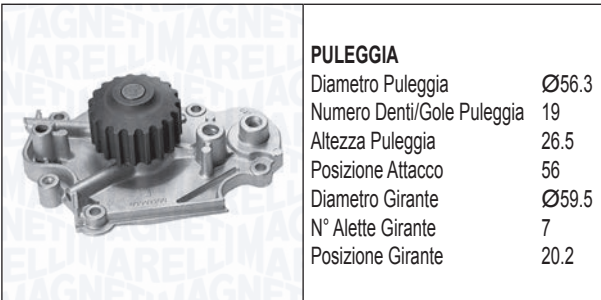
**81709 350981709000**

**PULEGGIA**

Diametro Puleggia	Ø56.3
Numero Denti/Gole Puleggia	19
Altezza Puleggia	26.5
Posizione Attacco	56
Diametro Girante	Ø59.5
N° Alette Girante	7
Posizione Girante	20.2

**HONDA**
**Accord V, Aerodeck, Coupé**

2.3 i SR	116	03/93 → 01/96	B	H23A3
----------	-----	---------------	---	-------

**HONDA**
**Prelude IV**

2.3 i 16V	118	02/92 → 09/96	B	H23A2
-----------	-----	---------------	---	-------

**ROVER**
**600**

623 Si	116	08/93 → 02/99	B	H23A3
--------	-----	---------------	---	-------

**81710 350981710000**

**PULEGGIA**

Diametro Puleggia	Ø59.31
Numero Denti/Gole Puleggia	20
Altezza Puleggia	33.8
Posizione Attacco	42.5
Diametro Girante	Ø60
N° Alette Girante	6
Posizione Girante	40

**CITROËN**
**Xantia I, Break**

1.8 i 16V	81	06/95 → 01/98	B	LFY (XU7JP4)	11-1996 →
-----------	----	---------------	---	-----------------	-----------

**Xantia II, Break**

1.8 i 16V	81	01/98 → 04/03	B	LFY (XU7JP4)
-----------	----	---------------	---	-----------------

**Xsara, Break, Coupé, Picasso, Van**

1.8 i 16V	81	04/97 → 09/00	B	LFY (XU7JP4)	07-1997 →
	81	10/97 → 09/00	B	LFY (XU7JP4)	
1.8 LPG	81	05/98 → 08/00		LFY (XU7JP4)	

**ZX, Break**

1.8 i 16V	81	01/96 → 06/97	B	LFY (XU7JP4)
-----------	----	---------------	---	-----------------

**81710 350981710000**



**PEUGEOT**

**306, Station Wagon, Coupé, Cabrio, Van**

1.8 16V	81	03/97 → 05/01	B	LFY (XU7JP4)	
---------	----	---------------	---	-----------------	--

**407, Station Wagon, Coupé**

1.8 16V	85	10/00 → 05/04	B	6FZ (EW7J4)	
	81	11/95 → 10/00	B	LFY (XU7JP4)	

**81711 350981711000**

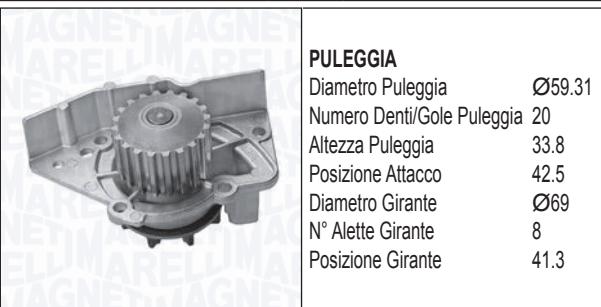

**CITROËN**

**Evasion**

2.0 16V	97	05/98 → 04/00	B	RFV (XU10J4R)	
---------	----	---------------	---	------------------	--

**Xantia I, Break**

2.0 i 16V	97	06/95 → 01/98	B	RFV (XU10J4R)	11-1996 →
-----------	----	---------------	---	------------------	-----------

**Xantia II, Break**

2.0 i 16V	97	01/98 → 04/03	B	RFV (XU10J4R)	
-----------	----	---------------	---	------------------	--

**XM II, Break**

2.0 i 16V	97	05/94 → 10/00	B	RFV (XU10J4R)	08-1994 →
-----------	----	---------------	---	------------------	-----------

**Xsara, Break, Coupé, Picasso, Van**

2.0 16V	97	07/98 → 09/00	B	RFV (XU10J4R)	
	120	04/97 → 09/00	B	RFS (XU10J4RS)	01-1998 →
2.0 i 16V	120	02/98 → 03/05	B	RFS (XU10J4RS)	

**FIAT**

**Ulysse I**

2.0 16V	100	09/00 → 08/02	B	RFN (EW10J4)	
	97	05/98 → 09/00	B	RFV	

**81711 350981711000**



**LANCIA**

**Zeta**

2.0 16V	97	05/98 → 07/00	B	RFV (XU10J4R)	
---------	----	---------------	---	------------------	--

**PEUGEOT**

**306, Station Wagon, Coupé, Cabrio, Van**

2.0	97	03/97 → 05/01	B	RFV (XU10J4R)	
	97	03/97 → 05/01	B	RFV (XU10J4R)	
2.0 16V	99	03/97 → 06/00	B	RFV (XU10J4R)	
	120	03/96 → 05/01	B	RFS (XU10J4RS)	

**407, Station Wagon, Coupé**

2.0	104	11/96 → 03/99	B	RGY (XU10J2TE)	
2.0 16V	97	11/95 → 05/04	B	RFV (XU10J4R)	→ 03-1999
	97	03/97 → 12/04	B	RFV (XU10J4R)	→ 12-1999
2.0 16V	99	04/99 → 09/04	B	RFV (XU10J4R)	

**605**

2.0 16V	97	07/94 → 09/99	B	RFV (XU10J4R)	
---------	----	---------------	---	------------------	--

**806**

2.0 16V	97	05/98 → 09/00	B	RFV (XU10J4R)	
---------	----	---------------	---	------------------	--

**81712**
**350981712000**

**KW**

**CITROËN**
**Jumper I**

2.5 D	63	08/94 → 04/02	D	T9A (DJ5)	05-1996 →
2.5 D 4x4	63	08/96 → 04/02	D	T9A (DJ5)	
2.5 DT 4x4	76	10/96 → 08/97	D	THZ (DJ5T)	
2.5 TD	76	08/94 → 04/02	D	T8A (DJ5T)	05-1996 →
2.5 TD 4x4	76	08/96 → 04/02	D	T8A (DJ5T)	
2.5 TDi	79	12/96 → 11/00	D	THX (DJ5TED)	
2.5 TDi 4x4	79	12/96 → 11/00	D	THX (DJ5TED)	

**XM II, Break**

2.5 TD	95	05/94 → 10/00	D	THY (DK5ATE)	PROD →: 7144
--------	----	---------------	---	--------------	--------------

**PEUGEOT**
**605**

2.5 Turbo Diesel	95	07/94 → 09/99	D	THY (DK5ATE)	04-1995 →, PROD →: 7144
------------------	----	---------------	---	--------------	-------------------------

**Boxer I**

2.5 D	63	08/94 → 04/02	D	T9A (DJ5)	06-1996 →, PROD →: 7144
2.5 D 4x4	63	07/96 → 04/02	D	T9A (DJ5)	
2.5 DT	62	10/97 → 11/01	D		
2.5 TD	76	07/94 → 04/02	D	T8A (DJ5T)	06-1996 →, PROD →: 7144
2.5 TD 4x4	76	07/96 → 04/02	D	T8A (DJ5T)	
2.5 TDi	79	01/97 → 04/02	D	THX (DJ5TED)	
2.5 TDi 4x4	79	01/97 → 04/02	D	THX (DJ5TED)	

**81713**
**350981713000**

**KW**

**CITROËN**
**Berlingo I, Van**

1.9 D	51	07/98 → 10/05	D	WJY (DW8B), WJZ (DW8)	
1.9 D 4WD	51	07/98 →	D	WJY (DW8B), WJZ (DW8)	
1.9 D 70	51	04/99 →	D	WJY (DW8B), WJZ (DW8)	
1.9 D 70 4WD	51	07/98 →	D	WJY (DW8B), WJZ (DW8)	
2.0 HDi 4x4	66	11/02 → 10/05	D	RHY (DW10TD)	
2.0 HDI 90	66	12/99 →	D	RHY (DW10TD)	
2.0 HDI 90 4WD	66	11/00 →	D	RHY (DW10TD)	

**C 15**

1.9 D	44	12/00 → 12/05	D	WJX (DW8B)	
-------	----	---------------	---	------------	--

**C 4 I, Coupé, Picasso, Grand Picasso**

2.0 HDi	81	04/07 → 07/08	D	RHZ (DW10ATED)	
---------	----	---------------	---	----------------	--

**C 5 I, Break**

2.0 HDi	79	03/01 → 08/04	D	RHS (DW10ATED), RHZ (DW10ATED)	
	80	06/01 → 08/04	D	RHZ (DW10ATED)	
	66	03/01 → 08/04	D	RHY (DW10TD)	
	79	06/01 → 08/04	D	RHS (DW10ATED), RHZ (DW10ATED)	
	80	03/01 → 08/04	D	RHZ (DW10ATED)	

**81713**
**350981713000**

**KW**

**CITROËN**
**C 8**

2.0 HDi	79	07/02 →	D	RHM (DW10ATED4), RHT (DW10ATED4)
---------	----	---------	---	---

**Evasion**

2.0 HDI	80	08/99 → 07/02	D	RHZ (DW10ATED)
2.0 HDI 16V	80	09/99 → 07/02	D	RHW (DW10ATED4)

**Jumper I**

2.0 HDI	62	11/01 → 04/02	D	RHV (DW10UTD)
---------	----	---------------	---	------------------

**Jumper II**

2.0 HDi	62	04/02 →	D	RHV (DW10TD), RHV (DW10UTD)
	62	04/02 →	D	RHV (DW10UTD)

**Jumpy I**

1.9 D 70	51	04/98 →	D	WJY (DW8B), WJZ (DW8)
2.0 HDi 110	80	03/00 →	D	RHW (DW10ATED4)
	80	03/00 →	D	RHZ (DW10ATED)
2.0 HDi 95	69	10/99 →	D	RHX (DW10BTED)

**Jumpy II**

2.0 HDi 110	80	12/03 → 10/06	D	RHZ (DW10ATED)
2.0 HDi 110 16V	80	12/03 → 10/06	D	RHW (DW10ATED4)
2.0 HDi 95	69	10/99 →	D	RHX (DW10BTED)

**Xantia II, Break**

2.0 HDI 109	80	02/99 → 04/03	D	RHZ (DW10ATED)
2.0 HDI 90	66	03/99 → 04/03	D	RHY (DW10TD)

**81713**
**350981713000**

**KW**

**CITROËN**
**Xsara, Break, Coupé, Picasso, Van**

1.9 D	51	07/98 → 03/05	D	WJY (DW8B), WJZ (DW8)
2.0 HDi	66	09/00 → 03/05	D	RHY (DW10TD)
2.0 HDi 109	80	05/01 → 03/05	D	RHZ (DW10ATED)
2.0 HDi 90	66	02/99 → 03/05	D	RHY (DW10TD)

**FIAT**
**Ducato III**

2.0 JTD	62	10/01 → 04/02	D	RHV (DW10)
---------	----	---------------	---	------------

**Ducato IV**

2.0 JTD	62	04/02 →	D	RHV (DW10)
---------	----	---------	---	------------

**Scudo I**

2.0 JTD	69	01/04 → 12/06	D	RHX
	80	12/99 → 12/06	D	RHZ
2.0 JTD 16V	80	05/99 → 12/06	D	RHW (DW10ATED)

**Ulysse I**

2.0 JTD	80	10/99 → 08/02	D	RHZ
2.0 JTD 16V	80	05/99 → 08/02	D	RHW (DW10ATED)

**Ulysse II**

2.0 JTD	79	05/03 → 08/06	D	RHM (DW10ATED)
	80	08/02 → 08/06	D	RHW (DW10ATED)

**LANCIA**
**Phedra**

2.0 JTD	79	07/03 → 11/10	D	RHM (DW10ATED)
	80	09/02 → 11/10	D	RHW (DW10ATED)

**Zeta**

2.0 JTD	80	04/00 → 09/02	D	RHZ (DW10ATED)
2.0 JTD 16V	80	09/99 → 09/02	D	RHW, RHW (DW10ATED)



**81713 350981713000**

**PEUGEOT**
**205 II, Van**

1.9 D	51	09/98 → 11/01	D	WJY (DW8B), WJZ (DW8)
2.0 HDI 90	66	12/99 →	D	RHY (DW10TD)

**206, CC, Van**

1.9 D	51	04/99 → 05/07	D	WJZ (DW8)
2.0 HDi	66	07/02 →	D	RHY (DW10TD)

**306, Station Wagon, Coupé, Cabrio, Van**

1.9 D	51	09/98 → 05/01	D	WJY (DW8B), WJZ (DW8)
2.0 HDI 90	66	06/99 → 05/01	D	RHY (DW10TD)

**307, Station Wagon, CC**

2.0 HDi 110	79	08/00 →	D	RHS (DW10ATED)
2.0 HDi 90	66	08/00 →	D	RHY (DW10TD)

**407, Station Wagon, Coupé**

2.0 HDi 110	79	08/01 → 05/04	D	RHS (DW10ATED), RHZ (DW10ATED)
2.0 HDI 110	80	06/98 → 08/01	D	RHZ (DW10ATED)
2.0 HDI 90	66	02/99 → 05/04	D	RHY (DW10TD)

**607**

2.0 HDi	79	03/01 → 07/04	D	RHS (DW10ATED)
2.0 HDI	80	05/00 →	D	RHZ (DW10ATED)

**806**

2.0 HDI	80	08/99 → 08/02	D	RHZ (DW10ATED)
2.0 HDI 16V	80	08/99 → 08/02	D	RHW (DW10ATED4)

**807**

2.0 HDi	79	06/02 →	D	RHM (DW10ATED4), RHT (DW10ATED4), RHW (DW10ATED4)
---------	----	---------	---	---

**81713 350981713000**

**PEUGEOT**
**Boxer I**

2.0 HDI	62	08/01 → 04/02	D	RHV (DW10UTD)
2.0 HDi	62	04/02 →	D	RHV (DW10TD), RHV (DW10UTD)

**Expert I**

1.9 D	51	12/03 →	D	WJY (DW8B), WJZ (DW8)
1.9 D 70	51	12/98 →	D	WJY (DW8B), WJZ (DW8)
2.0 HDi	69	10/00 → 11/03	D	RHX (DW10BTED)
	80	10/00 → 10/06	D	RHW (DW10ATED4)
	80	07/00 →	D	RHZ (DW10ATED), RHZ (DW10BTED), RHZ (DW10CTED)
2.0 HDI 16V	80	07/00 →	D	RHW (DW10ATED4)

**Partner I**

1.9 D	51	06/96 →	D	WJY (DW8B), WJZ (DW8)
1.9 D 4x4	51	04/04 → 08/05	D	WJY (DW8B)
2.0 HDI	66	02/00 →	D	RHY (DW10TD)
2.0 HDi 4x4	66	04/04 →	D	RHY (DW10TD)

**SUZUKI**
**Grand Vitara I**

2.0 HDI 110 16V	80	07/01 → 09/05	D	RHW, RHZ
-----------------	----	---------------	---	----------

**81714**
**350981714000**

FLANGIA	
Numero Fori Flangia	4
Dimensione Fori Flangia	M6×1
Posizione Attacco	87.5
Diametro Mozzo	Ø23.5
Diametro Girante	Ø61
N° Alette Girante	7
Posizione Girante	2

**KW**

**DAIHATSU**
**Applause I**

1.6 16V	66	06/89 → 07/97	B	HD
	77	06/89 → 07/97	B	HD-E
1.6 16V 4WD	77	06/89 → 07/97	B	HD-E

**Applause II**

1.6 16V	73	07/97 → 05/00	B	HD-E
---------	----	---------------	---	------

**Charade III**

1.3	56	09/88 → 01/92	B	HC-C
	66	11/90 → 02/93	B	HCE
1.3 i	66	06/88 → 12/92	B	HCE
1.3 i 4WD	66	06/88 → 01/93	B	HCE

**Charade IV**

1.0	38	09/94 → 03/96	B	CB22
1.3	44	09/96 → 11/99	B	HC
1.3 16V	55	05/96 → 11/99	B	HCE
1.3 i 16V	62	01/93 → 09/00	B	HC, HCE
1.5 16V	55	10/94 →	B	HEE
1.5 HG	55	06/94 → 03/96	B	HEE, HEEG
1.5 i 16V	66	08/94 →	B	HEE
	66	01/97 → 11/99	B	HEE, HEEG
1.6 GTi	77	03/93 → 11/99	B	HD-E

**Gran Move**

1.5 16V	66	10/96 → 07/98	B	HEEG
1.6 16V	67	05/98 →	B	HDEP
1.6 GLX	77	06/98 → 07/02	B	HDEP
1.6 GX	67	06/98 → 07/02	B	HDEP

**Hijet IV**

1.3 i 16V	48	05/98 →	B	HCE
-----------	----	---------	---	-----

**Rocky Soft Top, Hard Top**

2.8 TD	67	12/87 → 04/93	D	DL51
	75	09/91 → 12/98	D	DL52, DLT

**81715**
**350981715000**

FLANGIA	
Numero Fori Flangia	4
Dimensione Fori Flangia	M6×1
Posizione Attacco	87.4
Diametro Mozzo	Ø32
Diametro Girante	Ø61
N° Alette Girante	7
Posizione Girante	2

**KW**

**DAIHATSU**
**Feroza Soft Top, Hard Top**

1.6 16V	63	10/88 → 12/99	B	HDC
1.6 i 16V	70	10/88 → 12/99	B	HD-E
1.6 i 16V 4x4	70	10/88 → 12/99	B	HD-E

**Terios I**

1.3 4WD	61	10/97 → 10/00	B	HC-EJ
---------	----	---------------	---	-------

**81716**
**350981716000**

FLANGIA	
Numero Fori Flangia	3
Dimensione Fori Flangia	M6×1
Posizione Attacco	76.3
Diametro Mozzo	Ø23.5
Diametro Girante	Ø57
N° Alette Girante	8
Posizione Girante	12

**KW**

**FORD**
**Fiesta IV, Van**

1.3 i	37	08/95 → 01/02	B	JJA, JJC, JJE, JJJ, JJK, JJM
	44	08/95 → 01/02	B	J4C, J4J, J4L, J4Q, J4R, J4T, JBC

**KA I, StreetKa, Van**

1.0 i	38	07/97 → 09/99	B	ZH10JRB
	48	09/99 → 11/08	B	
1.3 i	36	06/98 → 11/08	B	JJD, JJF, JJG, JJH, JJJ
	37	09/96 → 10/02	B	JJB
	44	09/96 → 11/08	B	BAA, J4D, J4K, J4M, J4N, J4P, J4S

M: J4P, M: J4D, M: J4K, M: J4P

**81716**
**350981716000**

**MAZDA**
**121**

1.3	37	03/96 → 04/03	B	JJK, JJM
	44	03/96 → 04/03	B	J4R, J4T

**81717**
**350981717000**

**PULEGGIA**

Diametro Puleggia	Ø62.35
Numero Denti/Gole Puleggia	21
Altezza Puleggia	26.5
Posizione Attacco	47
Diametro Girante	Ø63
N° Alette Girante	6
Posizione Girante	52.5

**LADA**
**110**

1.5	54	01/95 →	B	BA32111
	56	10/00 →	B	VAZ-2111
	57	01/95 →	B	VAZ-2111

**Samara**

1.5	57	04/96 →	B	VAZ-2111
1100	43	02/96 →	B	BA321081
	39	02/88 → 12/94	B	BA321081 03-1992 →
1300	45	09/91 →	B	BA32108 03-1992 →
	48	01/86 → 12/94	B	BA32108 03-1992 →
	50	02/96 →	B	BA321115
1500	52	02/95 →	B	BA32111
	50	09/91 →	B	BA321083 03-1992 →

**Samara Forma**

1.5	57	01/00 →	B	VAZ-2111
1100	39	07/91 →	B	BA321081 03-1992 →
1300	45	07/91 →	B	BA32108 03-1992 →
	46	05/90 →	B	BA32108 03-1992 →
	48	05/89 → 07/97	B	BA32108 03-1992 →
	50	02/96 →	B	BA321115
1500	52	11/94 →	B	BA32111
	50	07/91 →	B	BA321083 03-1992 →
	53	09/91 →	B	BA321083 03-1992 →

**81722**
**350981722000**

**FLANGIA**

Numero Fori Flangia	3
Dimensione Fori Flangia	M8×1.25
Posizione Attacco	128.2
Diametro Mozzo	Ø30
Diametro Girante	Ø77
N° Alette Girante	4
Posizione Girante	22

**DAEWOO**
**Korando, Cabrio**

3.2 4x4	156	01/99 →	B	M104.995
---------	-----	---------	---	----------

**Musso**

3.2 4x4	162	01/99 →	B	M104.992
---------	-----	---------	---	----------

**MERCEDES-BENZ**
**Classe C I (W202), Station Wagon (S202)**

C 200 D	55	03/93 → 05/00	D	OM601.913
	142	05/93 → 05/00	B	M104.941
C 280	145	06/97 → 05/00	B	M112.920
	145	06/97 → 03/01	B	M112.920
C 36 AMG	206	05/94 → 05/00	B	M104.941 (AMG3.6)

**Classe E I (W124), Station Wagon (S124), Cabrio (A124), Coupé (C124)**

E 280	142	06/93 → 06/95	B	M104.942	06-1993 →, → 06-1995
	145	06/93 → 06/95	B	M104.942	06-1993 →, → 06-1995
E 280 T	142	06/93 → 06/96	B	M104.942	06-1993 →, → 01-1996
	145	06/93 → 06/96	B	M104.942	06-1993 →, → 01-1996
E 320	162	06/93 → 06/95	B	M104.992	06-1993 →
	162	06/93 → 03/98	B	M104.992, M104.995	06-1993 →
E 320 T	162	06/93 → 06/96	B	M104.992	06-1993 →
E 36 AMG	200	05/94 → 03/98	B	M104.992 (AMG3.6)	

**Classe E II (W210), Station Wagon (S210)**

E 280	142	01/96 → 06/97	B	M104.945
	150	12/96 → 03/02	B	M112.921
E 280 4-matic	150	12/96 → 03/02	B	M112.921
E 280 T	150	12/96 → 03/03	B	M112.921
E 280 T 4-matic	150	12/96 → 03/03	B	M112.921

81722 350981722000



## MERCEDES-BENZ

### Classe E II (W210), Station Wagon (S210)

E 320	162	06/95 → 06/97	B	M104.992, M104.995	
	165	06/97 → 03/02	B	M112.941	

E 320 4-matic	165	06/97 → 03/02	B	M112.941	
------------------	-----	---------------	---	----------	--

E 320 T	165	12/96 → 03/03	B	M112.941	
---------	-----	---------------	---	----------	--

E 320 T 4-matic	165	12/96 → 03/03	B	M112.941	
--------------------	-----	---------------	---	----------	--

### Coupé III (C124)

320 CE	162	10/92 → 05/93	B	M104.992	
--------	-----	---------------	---	----------	--

### Kombi II (S124)

280 TE	145	10/92 → 06/93	B	M104.942	
--------	-----	---------------	---	----------	--

320 TE	162	10/92 → 06/93	B	M104.992	
--------	-----	---------------	---	----------	--

### Saloon (W124)

280 E	145	10/92 → 06/93	B	M104.942	01-1993 →
-------	-----	---------------	---	----------	-----------

320 E	162	10/92 → 06/93	B	M104.992	
-------	-----	---------------	---	----------	--

### SL III (R129)

280	142	08/93 → 10/01	B	M104.943	09-1994 →
	150	05/98 → 10/01	B	M112.923, M112.925	

81723 350981723000



**FLANGIA**

Numero Fori Flangia	4
Dimensione Fori Flangia	M6×1
Posizione Attacco	106
Diametro Mozzo	M30×1.5 SX
Diametro Centraggio	Ø35
Diametro Girante	Ø69
N° Alette Girante	8
Posizione Girante	21.5



## MERCEDES-BENZ

### 100

D	55	12/90 → 02/96	D	OM616, OM616.963	
---	----	---------------	---	---------------------	--

### Classe C I (W202), Station Wagon (S202)

C 200 T D	65	10/96 → 03/01	D	OM604.915	
-----------	----	---------------	---	-----------	--

C 220 D	55	07/96 → 05/00	D	OM604.910	
	70	08/93 → 05/00	D	OM604.910	

### Classe E II (W210), Station Wagon (S210)

E 200 D	65	01/96 → 03/02	D	OM604.917	
---------	----	---------------	---	-----------	--

	55	05/96 → 03/02	D	OM604.912	
--	----	---------------	---	-----------	--

	70	06/95 → 07/99	D	OM604.912	
--	----	---------------	---	-----------	--

81724 350981724000



**FLANGIA**

Numero Fori Flangia	3
Dimensione Fori Flangia	M8×1.25
Posizione Attacco	128.2
Diametro Mozzo	Ø30
Diametro Girante	Ø77
N° Alette Girante	4
Posizione Girante	22



## MERCEDES-BENZ

### Classe G (W460, W461), Cabrio (W463)

320 GE	155	09/94 → 11/97	B	M104.996	01-1995 →
--------	-----	---------------	---	----------	-----------

G 320	155	09/94 → 12/97	B	M104.996	01-1995 →
	158	07/97 →	B	M112.945	

G 36 AMG	200	01/95 →	B	M104.996 (AMG3,6)	
----------	-----	---------	---	----------------------	--

### Classe S IV (W140), Coupé (C140)

300 SE 2.8	145	01/93 → 10/98	B	M104.944	
------------	-----	---------------	---	----------	--

300 SE, SEL/ S320	170	03/91 → 10/98	B	M104.990, M104.994	
----------------------	-----	---------------	---	-----------------------	--

S 280	142	02/93 → 10/98	B	M104.944	
-------	-----	---------------	---	----------	--

### Classe S V (W220), Coupé (C215)

S 320	165	10/98 → 08/05	B	M112.944	
-------	-----	---------------	---	----------	--

### CLK I (C208), Cabrio (A208)

200 Kompressor	141	03/98 → 06/00	B	M111.944	
-------------------	-----	---------------	---	----------	--

### SL III (R129)

320	170	09/93 → 10/01	B	M104.991	
-----	-----	---------------	---	----------	--

## SSANGYONG

### Korando II, Cabrio

3.2	156	01/99 →	B	M104.995	
-----	-----	---------	---	----------	--

	162	06/97 →	B	M104.992	
--	-----	---------	---	----------	--

	154	12/96 →	B	M104.995	
--	-----	---------	---	----------	--

### Musso

3.2	162	06/96 →	B	M104.992	
-----	-----	---------	---	----------	--

### Rexton

3.2	162	04/02 →	B	G32D	
-----	-----	---------	---	------	--

**81725**
**350981725000**

**KW**

**MERCEDES-BENZ**
**Classe C I (W202), Station Wagon (S202)**

C 230 Kompressor	142	10/95 → 05/00	B	M111.975
------------------	-----	---------------	---	----------

C 230 T Kompressor	142	06/97 → 09/00	B	M111.975
--------------------	-----	---------------	---	----------

**Classe E II (W210), Station Wagon (S210)**

E 200 Kompressor	137	06/97 → 03/02	B	M111.947
------------------	-----	---------------	---	----------

E 200 T Kompressor	137	06/97 → 03/03	B	M111.947
--------------------	-----	---------------	---	----------

**CLK I (C208), Cabrio (A208)**

200	100	03/98 → 03/02	B	M111.941, M111.945
-----	-----	---------------	---	--------------------

200 Kompressor	120	06/00 → 06/02	B	M111.956
	141	06/97 → 06/00	B	M111.944

230 Kompressor	142	06/97 → 06/00	B	M111.973, M111.975
	145	06/00 → 06/02	B	M111.982

**CLK II (C209), Cabrio (A209)**

CLK200 CGI	125	07/03 → 03/10	B	M271.942
------------	-----	---------------	---	----------

**SLK I (R170)**

200 Kompressor	141	10/96 → 03/00	B	M111.943
----------------	-----	---------------	---	----------

230 Kompressor	142	09/96 → 03/00	B	M111.973
----------------	-----	---------------	---	----------

**81726**
**350981726000**

**KW**

**MERCEDES-BENZ**
**Classe C I (W202), Station Wagon (S202)**

C 250 Turbo-D	110	10/95 → 05/00	D	OM605.960	01-1997 →
---------------	-----	---------------	---	-----------	-----------

**Classe E I (W124), Station Wagon (S124), Cabrio (A124), Coupé (C124)**

E 250 D	83	07/93 → 06/95	D	OM605.911	M →: 033.730
---------	----	---------------	---	-----------	--------------

**Classe G (W460, W461), Cabrio (W463)**

350 G Turbo-D	100	09/91 → 09/97	D	OM603.972	01-1997 →, M →: 004.349
---------------	-----	---------------	---	-----------	-------------------------

G 300 TD	130	09/96 →	D	OM606.964
----------	-----	---------	---	-----------

**Kombi II (S124)**

250 T D	66	09/85 → 06/93	D	OM602.912	M →: 033.730
---------	----	---------------	---	-----------	--------------

**Saloon (W124)**

300 D	83	08/89 → 06/93	D	OM603.912	M →: 054.123
-------	----	---------------	---	-----------	--------------

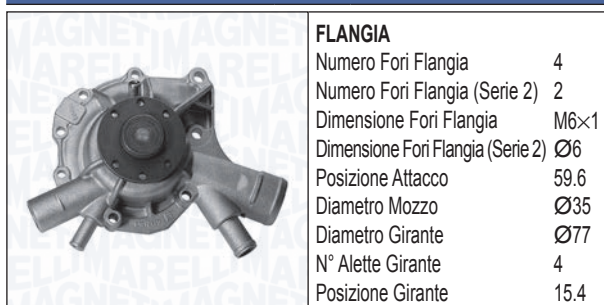
**81728**
**350981728000**

**KW**

**MERCEDES-BENZ**
**Classe V**

V 200	95	02/97 → 07/03	B	M111.948, M111.950	→ M: 002.353
-------	----	---------------	---	--------------------	--------------

V 230	105	10/96 → 07/03	B	M111.978	→ M: 001.594
-------	-----	---------------	---	----------	--------------

**Vito I (W638)**

113 2.0	95	02/96 → 07/03	B	M111.948, M111.950	→ M: 002.353
---------	----	---------------	---	--------------------	--------------

114 2.3	105	12/96 → 07/03	B	M111.978, M111.980	→ M: 001.954
---------	-----	---------------	---	--------------------	--------------

**81728 350981728000**



**MERCEDES-BENZ**

**Vito I (W638)**

114 2.3	105	03/97 → 07/03	B	M111.978, M111.980	→ M: 001.594
---------	-----	---------------	---	-----------------------	--------------

**81729 350981729000**



**FLANGIA**

Numero Fori Flangia	4
Numero Fori Flangia (Serie 2)	2
Dimensione Fori Flangia	M6×1
Dimensione Fori Flangia (Serie 2)	Ø6
Posizione Attacco	59.6
Diametro Mozzo	Ø35
Diametro Girante	Ø77
N° Alette Girante	4
Posizione Girante	15.4



**MERCEDES-BENZ**

**Classe V**

V 200	95	02/97 → 07/03	B	M111.948, M111.950	M →: 002.354
-------	----	---------------	---	-----------------------	--------------

V 230	105	10/96 → 07/03	B	M111.978	M →: 001.595
-------	-----	---------------	---	----------	--------------

**Vito I (W638)**

113 2.0	95	02/96 → 07/03	B	M111.948, M111.950	M →: 002.354
---------	----	---------------	---	-----------------------	--------------

114 2.3	105	12/96 → 07/03	B	M111.978, M111.980	M →: 001.595
---------	-----	---------------	---	-----------------------	--------------

**81730 350981730000**



**FLANGIA**

Numero Fori Flangia	4
Dimensione Fori Flangia	M6×1
Posizione Attacco	83.5
Diametro Mozzo	M30×1.5 SX
Diametro Centraggio	Ø35
Diametro Girante	Ø77.7
N° Alette Girante	6
Posizione Girante	13.35



**MERCEDES-BENZ**

**Classe C I (W202), Station Wagon (S202)**

C 240	125	06/97 → 05/00	B	M112.910	
-------	-----	---------------	---	----------	--

C 240 T	125	06/97 → 09/00	B	M112.910	
	125	09/00 → 03/01	B	M112.915	

C 43 AMG	225	08/97 → 05/00	B	M113.944	01-1998 →
----------	-----	---------------	---	----------	-----------

**81730 350981730000**



**MERCEDES-BENZ**

**Classe C II (W203), Station Wagon (S203), Coupé (CL203)**

C 240	125	05/00 → 02/07	B	M112.912	
-------	-----	---------------	---	----------	--

C 240 4-matic	125	07/02 → 02/07	B	M112.916	
	160	09/02 → 05/08	B	M112.946	

C 320	160	05/00 → 02/07	B	M112.946	
	160	07/02 → 02/07	B	M112.953	

C 320 4-matic	160	07/02 → 02/07	B	M112.953	
------------------	-----	---------------	---	----------	--

C 55 AMG	270	02/04 → 02/07	B	M113.988	
----------	-----	---------------	---	----------	--

**Classe E II (W210), Station Wagon (S210)**

E 240	125	06/97 → 08/00	B	M112.911	
	125	08/00 → 03/02	B	M112.914	

E 240 T	125	06/97 → 03/03	B	M112.911	
	125	08/00 → 03/03	B	M112.914	

E 430	205	06/97 → 03/02	B	M113.940	
-------	-----	---------------	---	----------	--

E 430 4-matic	205	05/99 → 03/02	B	M113.940	
------------------	-----	---------------	---	----------	--

E 430 T	205	06/97 → 03/03	B	M113.940	
---------	-----	---------------	---	----------	--

E 430 T 4-matic	205	05/99 → 03/03	B	M113.940	
--------------------	-----	---------------	---	----------	--

E 55 AMG	260	08/97 → 03/02	B	M113.980	
----------	-----	---------------	---	----------	--

E 55 T AMG	260	08/97 → 03/03	B	M113.980	01-1998 →
------------	-----	---------------	---	----------	-----------

**Classe E III (W211), Station Wagon (S211)**

E 240	130	03/02 → 12/08	B	M112.913, M112.917	→ M: 036.808
-------	-----	---------------	---	-----------------------	--------------

E 240 4-matic	130	03/03 → 12/08	B	M112.917	
------------------	-----	---------------	---	----------	--

E 240 T	130	03/03 → 07/09	B	M112.913	
---------	-----	---------------	---	----------	--

E 240 T 4-matic	130	07/03 → 07/09	B	M112.917	
--------------------	-----	---------------	---	----------	--

E 320	165	03/02 → 12/08	B	M112.949	
-------	-----	---------------	---	----------	--

E 320 4-matic	165	03/03 → 12/08	B	M112.954	
------------------	-----	---------------	---	----------	--

E 320 T	165	03/03 → 07/09	B	M112.949	
---------	-----	---------------	---	----------	--

E 320 T 4-matic	165	07/03 → 07/09	B	M112.954	
--------------------	-----	---------------	---	----------	--

E 500	225	03/02 → 12/08	B	M113.967	
	285	04/06 → 12/08	B	M273.960	

E 500 4-matic	225	10/03 → 12/08	B	M113.969	
	285	04/06 → 12/08	B	M273.962	

E 500 T	225	10/03 → 07/09	B	M113.967	
	285	04/06 → 07/09	B	M273.960	

E 500 T 4-matic	225	10/03 → 07/09	B	M113.969	
	285	04/06 → 07/09	B	M273.962	

**81730 350981730000**

**MERCEDES-BENZ**
**Classe G (W460, W461), Cabrio (W463)**

G 320	158	11/97 →	B	M112.945
G 500	218	04/98 →	B	M113.962
G 55 AMG	260	04/99 →	B	M113.982

**Classe M I (W163)**

ML 320	160	02/98 → 08/02	B	M112.942
ML 350	180	08/02 → 06/05	B	M112.970
ML 350 4-matic	173	02/03 → 06/05	B	M112.970
ML 430	200	02/98 → 06/05	B	M113.942
ML 500	215	09/01 → 06/05	B	M113.964, M113.965
ML 55 AMG	255	02/00 → 06/05	B	M113.981 → M: M036.808

**Classe M II (W164)**

ML 500 4-matic	225	07/05 →	B	M113.964
----------------	-----	---------	---	----------

**Classe S V (W220), Coupé (C215)**

CL 500	225	03/99 → 03/06	B	M113.960 → M: 036.808
CL 55 AMG	265	10/99 → 03/06	B	M113.986
S 280	150	10/98 → 08/05	B	M112.922
S 350	180	09/02 → 08/05	B	M112.972
S 350 4-matic	180	06/03 → 08/05	B	M112.975
S 430	205	10/98 → 08/05	B	M113.941 → M: 036.808
S 430 4-matic	205	09/02 → 08/05	B	M113.948
S 500 4-matic	225	09/02 → 08/05	B	M113.966
S 55 AMG	265	04/99 → 08/05	B	M113.986

**CLK I (C208), Cabrio (A208)**

320	160	06/97 → 06/02	B	M112.940
320	160	03/98 → 03/02	B	M112.940
430	205	07/98 → 06/02	B	M113.943
55 AMG	255	08/99 → 06/02	B	M113.981, M113.984

**CLK II (C209), Cabrio (A209)**

240	120	06/02 → 05/09	B	M112.912
	125	06/02 → 05/09	B	M112.912
320	160	06/02 → 05/09	B	M112.955
500	225	06/02 → 05/09	B	M113.968
55 AMG	270	09/02 → 05/09	B	M113.987
CLK 240	125	02/03 → 03/10	B	M112.912
CLK 320	160	02/03 → 03/10	B	M112.955
CLK 500	225	02/03 → 03/10	B	M113.968
CLK 55 AMG	270	02/03 → 03/10	B	M113.987

**81730 350981730000**

**MERCEDES-BENZ**
**CLK II (C209), Cabrio (A209)**

CLK AMG DTM	428	06/04 → 03/10	B	M113.994
DTM AMG	428	06/04 → 05/09	B	M113.994

**CLS I (C219)**

CLS 500	225	10/04 → 12/10	B	M113.967
---------	-----	---------------	---	----------

**SL III (R129)**

320	165	05/98 → 10/01	B	M112.943
-----	-----	---------------	---	----------

**SL IV (R230)**

350	180	03/03 → 01/12	B	M112.973
500	225	10/01 → 01/12	B	M113.963 → M: 036.808

**SLK I (R170)**

320	160	03/00 → 04/04	B	M112.947
-----	-----	---------------	---	----------

**Vito II (W639) - Viano**

119	140	09/03 →	B	M112.951
122	160	09/03 →	B	M112.951
123	170	06/04 →	B	M112.976 → M: 31.000.000
	170	06/04 → 07/08	B	M112.976 → M: 31.000.000
3,0	140	09/03 →	B	M112.951
3.2	160	09/03 →	B	M112.951
3.7	170	06/04 →	B	M112.976 → M: 31.000.000

**81731 350981731000**

<b>PULEGGIA</b>	
Diametro Puleggia	Ø59.8
Numero Denti/Gole Puleggia	24
Altezza Puleggia	32.5
Posizione Attacco	65.7
Diametro Girante	Ø59
N° Alette Girante	8
Posizione Girante	1

**MITSUBISHI**
**Colt IV**

1.6 4WD	84	08/93 → 08/95	B	4G92 (SOHC16V)
1.6 GLXi 16V	83	04/92 → 04/96	B	4G92 (SOHC16V)
1.8 GTi 16V	103	04/92 → 04/96	B	4G93 (DOHC16V), 4G93 (SOHC16V)

**81731 350981731000**

**MITSUBISHI**
**Galant V, Station Wagon**

1.8	85	02/94 → 08/96	B	4G93 (SOHC16V)	
1.8 GLSi	93	11/92 → 08/96	B	4G93 (SOHC16V)	01-1993 →
	93	11/92 → 08/96	B	4G93 (SOHC16V)	

**Lancer III, Station Wagon**

1.8 4WD	69	08/90 → 06/92	B	4G37	01-1992 →
---------	----	---------------	---	------	-----------

**Lancer IV, Station Wagon**

1.6 16V	83	06/92 → 05/94	B	4G92 (SOHC16V)	
1.6 4WD	84	06/92 → 11/93	B	4G92 (SOHC16V)	
1.8 GTi 16V	103	06/92 → 12/93	B	4G93 (DOHC16V), 4G93 (SOHC16V)	

**Lancer V, Station Wagon, Hatchback, Coupé**

1.6	66	02/94 → 12/96	B	4G92 (SOHC16V)	
1.6 16V	83	06/92 → 12/96	B	4G92 (SOHC16V)	
	83	12/92 → 10/03	B	4G92 (SOHC16V)	→ 02-1996
1.6 16V 4WD	83	06/92 → 12/96	B	4G92 (SOHC16V)	
	83	12/92 → 10/03	B	4G92 (SOHC16V)	→ 02-1996
1.8 16V	103	06/92 → 12/93	B	4G93 (DOHC16V)	

**Space Runner I**

1.8	85	06/96 → 08/99	B	4G93 (SOHC16V)	
	90	10/91 → 08/99	B	4G93 (SOHC16V)	
1.8 4WD	85	06/96 → 08/99	B	4G93 (SOHC16V)	
	90	10/91 → 08/99	B	4G93 (SOHC16V)	

**Space Wagon II**

1.8	90	10/91 → 10/98	B	4G93 (SOHC16V)	
1.8 4WD	90	10/91 → 10/98	B	4G93 (SOHC16V)	

**81731 350981731000**

**PROTON**
**Persona 400**

416 i	70	12/95 →	B	4G92	
-------	----	---------	---	------	--

**81733 350981733000**

**PULEGGIA**

Diametro Puleggia	Ø59.35
Numero Denti/Gole Puleggia	20
Altezza Puleggia	35
Posizione Attacco	60
Diametro Girante	Ø68.3
N° Alette Girante	6
Posizione Girante	12

**CHRYSLER**
**Neon I**

1.8 16V	85	09/97 → 08/99	B	EBD	
	98	05/94 → 08/99	B	420H	
2.0 16V	107	06/94 → 08/99	B	ECC	
	109	04/96 → 08/99	B	420T	

**Neon II**

1.6	85	11/01 → 12/06	B	EJD	
2.0 16V	98	08/99 → 12/06	B	420H, ECB	
2.0 16V R/T	110	10/01 → 12/06	B	ECH	

**PT Cruiser, Cabrio**

1.6	85	11/01 → 12/10	B	EJD	
	100	10/04 → 12/10	B	ECC	
2.0	104	06/00 → 12/10	B	ECC	

**Sebring II, Cabrio**

2.0	104	04/01 → 06/07	B	ECC	
-----	-----	---------------	---	-----	--

**Stratus, Cabrio**

2.0 16V	98	12/95 → 04/01	B	ECB	
2.0 LE	96	06/96 → 04/01	B	420X	
	96	12/95 → 04/01	B	C00	

**Voyager III**

2.0 i	98	01/95 → 03/01	B	C00	
-------	----	---------------	---	-----	--

**MITSUBISHI**
**Eclipse II, Cabrio**

2.0 Turbo	147	04/94 → 04/99	B	4G63T (DOHC16V)	
2.0 Turbo 4WD	157	12/95 → 04/99	B	4G63T (DOHC16V)	
	147	04/94 → 04/99	B	4G63T (DOHC16V)	



**81733 350981733000**

**MITSUBISHI**
**Eclipse II, Cabrio**

2000 GS 16V	107	12/95 → 04/99	B	4G63 (DOHC16V)
2000 GT 16V	157	12/95 → 04/99	B	4G63T (DOHC16V)

**81736 350981736000**

**NISSAN**
**Sunny III**

2.0 GTI 16V	105	10/90 → 05/95	B	SR20DE
2.0 GTI-R 4x4	162	10/90 → 05/95	B	SR20DET
2.0 i 16V	105	10/90 → 05/95	B	SR20DE

**81736 350981736000**

**FLANGIA**

Numero Fori Flangia	4
Dimensione Fori Flangia	M6×1
Posizione Attacco	51
Diametro Mozzo	Ø17.3
Diametro Girante	Ø72
N° Alette Girante	6
Posizione Girante	17.3

**NISSAN**
**100 NX**

2.0	110	10/90 → 10/94	B	SR20DE
2.0 GTI	105	03/91 → 10/94	B	SR20DE

**200 SX III**

2.0 i 16V	118	10/93 → 12/99	B	SR20DE
-----------	-----	---------------	---	--------

**Almera I, Hatchback**

2.0 D	55	11/95 → 07/00	D	CD20
2.0 GTi	105	07/96 → 03/00	B	SR20DE

**Almera Tino**

2.0	100	08/00 →	B	SR20DE
-----	-----	---------	---	--------

**Primera I, Hatchback, Station Wagon**

2.0	105	06/90 → 04/93	B	SR20DE
	110	06/90 → 01/96	B	SR20DE
2.0 16V	85	06/90 → 01/96	B	SR20DI
2.0 16V 4x4	85	04/91 → 06/96	B	SR20DI
2.0 GT	110	06/90 → 01/96	B	SR20DE
2.0 GT 4x4	105	03/91 → 04/93	B	SR20DE
2.0 i	85	07/90 → 03/98	B	SR20DI
	92	01/95 → 06/96	B	SR20DE

**Primera II, Hatchback, Station Wagon**

2.0 16V	85	09/96 → 12/01	B	SR20De
	96	09/96 → 12/01	B	SR20DE
	103	08/99 → 12/01	B	SR20DE
	110	09/96 → 12/01	B	SR20DE

**Serena I**

2.0 16V	93	11/92 → 09/01	B	SR20DE
---------	----	---------------	---	--------

**81742 350981742000**

**FLANGIA**

Numero Fori Flangia	3
Dimensione Fori Flangia	M6×1
Posizione Attacco	51
Diametro Mozzo	Ø17.2
Diametro Girante	Ø57
N° Alette Girante	8
Posizione Girante	19.5

**NISSAN**
**Micra II (K11)**

1.0 i 16V	40	08/92 → 09/00	B	CG10DE
	44	09/00 → 02/03	B	CG10DE
1.3 i 16V	55	08/92 → 09/00	B	CG13DE
1.4 i 16V	60	09/00 → 02/03	B	CGA3DE

**81743 350981743000**

**PULEGGIA**

Diametro Puleggia	Ø57.4
Numero Denti/Gole Puleggia	23
Posizione Attacco	35
Diametro Girante	Ø57
N° Alette Girante	8
Posizione Girante	12.7

**NISSAN**
**Micra I (K10)**

1.0	43	12/82 → 05/91	B		01-1989 →, M →: 945.693
	40	07/86 → 07/92	B	MA12S	01-1989 →, M →: 945.693
1.2	44	07/86 → 07/92	B	MA12S	01-1989 →, M →: 945.693

81744

350981744000

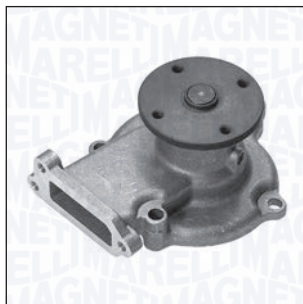

**FLANGIA**  
 Numero Fori Flangia 4  
 Dimensione Fori Flangia M6x1  
 Posizione Attacco 60.5  
 Diametro Mozzo Ø17.25  
 Diametro Girante Ø58  
 N° Alette Girante 6  
 Posizione Girante 10.5



NISSAN

100 NX

1.6	66	03/90 → 10/94	B	GA16DS
1.6 SR	75	09/93 → 10/94	B	GA16DE

Almera I, Hatchback

1.4	64	09/95 → 07/00	B	GA14DE
1.4 GX,LX	55	09/95 → 07/00	B	GA14DE
1.4 S,GX,LX	55	09/95 → 03/00	B	GA14DE
1.6	73	09/95 → 07/00	B	GA16DE
1.6 SLX	66	09/95 → 07/00	B	GA16DE
1.6 SR,SLX	66	09/95 → 03/00	B	GA16DE

Primeria I, Hatchback, Station Wagon

1.6	66	06/90 → 01/96	B	GA16DS
	71	06/90 → 01/96	B	GA16DS
	75	06/93 → 01/96	B	GA16DE
1.6 i	66	07/90 → 03/98	B	GA16DS
	75	02/91 → 03/98	B	GA16DE

Primeria II, Hatchback, Station Wagon

1.6 16V	66	09/96 → 12/01	B	GA16DE
	73	09/96 → 10/00	B	GA16DE
	78	06/96 → 12/01	B	QG16DE
	80	04/98 → 12/01	B	QG16DE

Serena I

1.6	75	10/94 → 08/00	B	GA16DE
1.6 16V	71	02/93 → 09/01	B	GA16DE

Sunny III

1.4	60	10/90 → 06/95	B	GA14DS
1.4 i	55	10/90 → 05/95	B	GA14DE, GA14DS
1.4 i 16V	64	10/90 → 06/95	B	GA14DE
1.6 16V 4x4	66	11/90 → 05/95	B	GA16DS
1.6 i	66	10/90 → 05/95	B	GA16DE, GA16DEL, GA16DS
	66	06/91 → 03/00	B	GA16DE, GA16DS
1.6 i 16V	66	10/92 → 03/00	B	GA16DE
	75	10/92 → 05/95	B	GA16DE

81744

350981744000



NISSAN

Sunny III

1.6 i 16V 4WD	66	10/90 → 05/95	B	GA16DS
	75	10/92 → 05/95	B	GA16DE
1.6 L	75	11/92 → 04/96	B	GA16DE
1.6 SR 4x4	66	01/92 → 06/95	B	GA16DEL

Vanette III Cargo

1.6 i	71	01/95 →	B	GA16DE
	72	01/96 →	B	GA16DE

81745

350981745000



**FLANGIA**  
 Numero Fori Flangia 4  
 Dimensione Fori Flangia M6x1  
 Posizione Attacco 84.6  
 Diametro Girante Ø70  
 N° Alette Girante 8  
 Posizione Girante 0.5



NISSAN

Almera I, Hatchback

2.0 D	55	11/95 → 03/00	D	CD20
-------	----	---------------	---	------

Primeria I, Hatchback, Station Wagon

2.0 D	55	01/91 → 01/96	D	CD20
-------	----	---------------	---	------

Primeria II, Hatchback, Station Wagon

2.0 TD	66	09/96 → 12/01	D	CD20T
--------	----	---------------	---	-------

Sunny III

2.0 D	55	10/90 → 05/95	D	CD20
-------	----	---------------	---	------

**81746**
**350981746000**

**FLANGIA**

Numero Fori Flangia	4
Dimensione Fori Flangia	M6×1
Posizione Attacco	75
Diametro Girante	Ø70
N° Alette Girante	6
Posizione Girante	7

**KW**

**OPEL**
**Astra F, Station Wagon, Cabrio, Van**

1.7 TDS	60	03/92 → 09/98	D	17DT (TC4EE1), X17DT (TC4EE1)	01-1993 →, M →: 855.806
---------	----	---------------	---	--	----------------------------

**Astra G, Station Wagon, Coupé, Cabrio, Van**

1.7 DTI 16V	55	02/00 → 01/05	D	Y17DT	→ 09-2000, → M: 073532
	55	02/00 → 07/04	D	Y17DT	→ 08-2000, → M: 073532

**Combo A**

1.7 D	44	07/94 → 10/01	D	17D (4EE1), X17D (4EE1)	M →: 877.698
-------	----	---------------	---	----------------------------	--------------

**Corsa B, Station Wagon, Van**

1.7 D	44	02/96 → 09/00	D	17D (4EE1), X17D (4EE1)	M →: 877.698
	44	08/99 → 09/00	D	17D (4EE1), X17D (4EE1)	
	44	01/99 →	D	X17D (4EE1)	

**Vectra B, Station Wagon**

1.7 TD	60	10/95 → 12/98	D	X17DT (TC4EE1)	
--------	----	---------------	---	-------------------	--

**81747**
**350981747000**

**FLANGIA**

Numero Fori Flangia	3
Dimensione Fori Flangia	M8×1.25
Posizione Attacco	33
Diametro Mozzo	Ø30
Diametro Girante	Ø70
N° Alette Girante	8
Posizione Girante	52.3

**KW**

**OPEL**
**Astra G, Station Wagon, Coupé, Cabrio, Van**

2.0 DI	60	01/99 → 04/05	D	X20DTL	
	60	02/98 → 01/05	D	X20DTL, Y20DTL	
2.0 DTI 16V	74	08/99 → 01/05	D	X20DTH, Y20DTH	
2.2 DTI	86	09/02 → 01/05	D	Y22DTR	
	92	09/02 → 01/05	D	Y22DTR	

**Frontera B**

2.2 DTI	88	09/02 →	D	Y22DTH	
	85	10/98 → 09/02	D	X22DTH, Y22DTH	

**Omega B, Station Wagon**

2.0 DTI 16V	74	09/97 → 09/00	D	X20DTH	
	81	09/00 → 07/03	D	Y22DTH	
	88	09/00 → 07/03	D	Y22DTH	

**Signum**

2.0 DTI	74	05/03 →	D	Y20DTH	
2.2 DTI	92	05/03 →	D	Y22DTR	

**Sintra**

2.2 DTI	85	07/97 → 04/99	D	X22DTH	
---------	----	---------------	---	--------	--

**Vectra B, Station Wagon**

2.0 DI 16V	60	11/96 → 04/02	D	X20DTL	
2.0 DTI 16V	74	06/97 → 04/02	D	X20DTH, Y20DTH	
	88	09/00 → 04/02	D	Y22DTR	
	92	09/00 → 04/02	D	Y22DTR	

**Vectra C, Station Wagon**

2.0 DTI	74	10/03 →	D	Y20DTH	
2.0 DTI 16V	74	04/02 →	D	Y20DTH	
2.2 DTI	92	10/03 →	D	Y22DTR	
2.2 DTI 16V	86	04/02 → 12/04	D	Y22DTR	
	92	04/02 →	D	Y22DTR	

## 81747 350981747000



### OPEL

#### Zafira A

2.0 DI	63	07/99 → 06/00	D	X20DTL
2.0 DI 16V	60	07/99 → 06/05	D	X20DTL
2.0 DTI 16V	74	09/00 → 06/05	D	Y20DTH
	86	01/02 → 06/05	D	Y22DTR
	92	01/02 → 06/05	D	Y22DTR

### SAAB

#### 9-3 I, Cabrio

2.2 TiD	85	02/98 → 11/00	D	D223L, X22DTH
	92	11/00 → 09/02	D	D223L

#### 9-3 II, Station Wagon, Cabrio

2.2 TiD	92	09/02 →	D	D223L
---------	----	---------	---	-------

#### 9-5 I, Station Wagon

2.2 TiD	88	03/02 → 12/09	D	D223L
---------	----	---------------	---	-------

### VAUXHALL

#### ZAFIRA

2.0 GSi Turbo	141	09/01 → 06/05	B	Z20LET
---------------	-----	---------------	---	--------

## 81748 350981748000



### FLANGIA

Numero Fori Flangia	4
Dimensione Fori Flangia	M6×1
Posizione Attacco	75
Diametro Girante	Ø64.5
N° Alette Girante	6
Posizione Girante	5.8



### OPEL

#### Corsa B, Station Wagon, Van

1.5 D	37	03/93 → 09/00	D	15D (4EC1)	09-1994 →, M →: 877.698
1.5 TD	49	03/93 → 09/00	D	15DT (T4EC1), X15DT (T4EC1)	→ 08-1994, M →: 877.698, → M: 076.350

### VAUXHALL

#### CORSA

1.5 D	37	12/92 → 12/96	D	15D	M →: 877.698
1.5 TD	49	03/93 → 10/96	D	15DT (T4EC1), X15DT (T4EC1)	03-1993 →, M →: 877.698

## 81749 350981749000

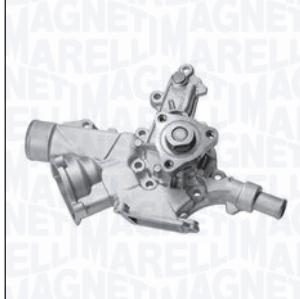

### FLANGIA

Numero Fori Flangia	3
Dimensione Fori Flangia	M8×1.25
Posizione Attacco	55.6
Diametro Mozzo	Ø29.9
Diametro Girante	Ø50
N° Alette Girante	8
Posizione Girante	21.45



### OPEL

#### Agila A

1.0 12V	43	09/00 → 12/07	B	Z10XE
1.2 16V	55	09/00 → 12/07	B	Z12XE

#### Astra G, Station Wagon, Coupé, Cabrio, Van

1.2 16V	48	02/98 → 09/00	B	X12XE
	55	09/00 → 01/05	B	Z12XE

#### Corsa B, Station Wagon, Van

1.0 i 12V	40	11/96 → 09/00	B	X10XE
1.2 i 16V	48	03/98 → 09/00	B	X12XE

#### Corsa C, Van

1.0	43	09/00 → 06/03	B	Z10XE
1.2	55	09/00 → 12/09	B	Z12XE
1.2 16V	55	09/00 →	B	Z12XE

### VAUXHALL

#### CORSA

1.0 12V	43	09/00 → 10/03	B	Z10XE
1.0 i 12V	40	11/96 → 09/00	B	X10XE

## 81750 350981750000



### FLANGIA

Numero Fori Flangia	4
Dimensione Fori Flangia	M6×1
Posizione Attacco	75
Diametro Girante	Ø64.5
N° Alette Girante	6
Posizione Girante	6.5



### OPEL

#### Corsa B, Station Wagon, Van

1.5 TD	49	03/93 → 09/00	D	15DT (T4EC1), X15DT (T4EC1)	09-1994 →, M →: 076.351
--------	----	---------------	---	-----------------------------	----------------------------

**81751**
**350981751000**

**KW**

**OPEL**
**Astra G, Station Wagon, Coupé, Cabrio, Van**

1.8 16V	85	02/98 → 09/00	B	X18XE1	
	92	09/00 → 01/05	B	Z18XE	

**Corsa C, Van**

1.8	92	09/00 → 12/09	B	Z18XE	
-----	----	---------------	---	-------	--

**Meriva A**

1.8	92	05/03 → 05/10	B	Z18XE	
-----	----	---------------	---	-------	--

**Signum**

1.8	90	05/03 →	B	Z18XE	
-----	----	---------	---	-------	--

**Tigra II Twin Top**

1.8	92	06/04 →	B	Z18XE	
-----	----	---------	---	-------	--

**Vectra B, Station Wagon**

1.8 i 16V	85	10/95 → 09/00	B	X18XE1, Z18XEL	01-1999 →, M: X18XE1
	92	09/00 → 04/02	B	Z18XE	

**Vectra C, Station Wagon**

1.8	81	04/02 →	B	Z18XEL	
	90	10/03 →	B	Z18XE	
1.8 16V	81	08/02 → 12/06	B	Z18XEL	
	90	04/02 →	B	Z18XE	

**Zafira A**

1.8 16V	85	04/99 → 09/00	B	X18XE1	
	92	09/00 → 06/05	B	Z18XE	

**SAAB**
**9-3 II, Station Wagon, Cabrio**

1.8 i	90	01/04 →	B	Z18XE	
-------	----	---------	---	-------	--

**VAUXHALL**
**VECTRA**

1.8 16V	90	04/02 → 07/08	B	Z18XE	
---------	----	---------------	---	-------	--

**81752**
**350981752000**

**KW**

**CITROËN**
**Jumper I**

2.5 D	63	08/94 → 04/02	D	T9A (DJ5)	→ 04-1996
2.5 TD	76	08/94 → 04/02	D	T8A (DJ5T)	→ 04-1996

**XM II, Break**

2.5 TD	95	05/94 → 10/00	D	THY (DK5ATE)	→ PROD: 7143
--------	----	---------------	---	-----------------	--------------

**PEUGEOT**
**605**

2.5 Turbo Diesel	95	07/94 → 09/99	D	THY (DK5ATE)	→ 03-1995, → PROD: 7143
------------------	----	---------------	---	-----------------	----------------------------

**Boxer I**

2.5 D	63	08/94 → 04/02	D	T9A (DJ5)	→ 05-1996, → PROD: 7143
2.5 TD	76	07/94 → 04/02	D	T8A (DJ5T)	→ 05-1996, → PROD: 7143

**81753**
**350981753000**

**KW**

**CITROËN**
**Berlingo I, Van**

1.6 16V	80	10/00 →	B	NFU (TU5JP4)	
	81	11/02 →	B	NFU (TU5JP4)	

**81753**
**350981753000**

**KW**

**CITROËN**
**Berlingo II, Van**

1.6	66	04/08 →	B	NFR (TU5JP4B)
	80	04/08 →	B	NFU (TU5JP4)
1.6 VTi 120	88	11/09 →	B	5FS (EP6C)

**C 2, Van**

1.6	80	09/03 →	B	NFU (TU5JP4)
1.6 VTS	90	01/05 →	B	NFS (TU5JP4S)

**C 3 I, Pluriel**

1.6	80	05/03 →	B	NFU (TU5JP4)
1.6 16V	80	02/02 →	B	NFU (TU5JP4)
	81	05/03 → 09/05	B	NFU (TU5JP4)

**C 4 I, Coupé, Picasso, Grand Picasso**

1.6 16V	80	11/04 → 07/11	B	NFU (TU5JP4)
1.6 16V Bio-Flex	80	09/07 → 07/08		NFU (TU5JP4)

**C-Elysee**

1.6 VTi 115	85	11/12 →	B	NFP (EC5)
-------------	----	---------	---	-----------

**Saxo**

1.5 D	43	07/01 → 04/04	D	
1.6	88	02/96 → 04/04	B	NFX (TU5JP4)
1.6 VTS	87	06/96 → 09/03	B	NFX (TU5JP4)

**Xsara, Break, Coupé, Picasso, Van**

1.6 16V	80	09/00 → 03/05	B	NFU (TU5JP4)
	80	09/00 → 03/05	B	NFU (TU5JP4)
	81	06/05 → 09/06	B	NFU (TU5JP4)

**PEUGEOT**
**106 II**

1.6 S16	87	05/96 →	B	NFX (TU5J4)
---------	----	---------	---	----------------

**205 II, Van**

1.6 16V	80	12/00 →	B	NFU (TU5JP4)
---------	----	---------	---	-----------------

**81753**
**350981753000**

**KW**

**PEUGEOT**
**206, CC, Van**

1.6 16V	80	07/02 →	B	NFU (TU5JP4)
	80	09/00 →	B	NFU (TU5JP4)

**207, Station Wagon, CC, Van**

1.6	81	08/08 →	B	N6A (TU5JP4)
1.6 16V	80	02/06 →	B	NFU (TU5JP4)
1.6 Bioflex	83	01/08 →		N6A (TU5JP4)

**301**

1.6 VTi 115	85	11/12 →	B	NFP (EC5)
-------------	----	---------	---	-----------

**307, Station Wagon, CC**

1.6	81	07/06 →	B	NFU (TU5JP4)
1.6 16V	80	08/00 →	B	NFU (TU5JP4)
1.6 BioFlex	80	09/07 →		NFU (TU5JP4)

**308 I, Station Wagon, CC**

1.6 BioFlex	80	04/08 →		NFU (TU5JP4)
-------------	----	---------	--	-----------------

**308 II Station Wagon**

1.6 VTi	85	03/14 →	B	
---------	----	---------	---	--

**1007**

1.6 16V	80	04/05 →	B	NFU (TU5JP4)
---------	----	---------	---	-----------------

**Partner I**

1.6	80	09/00 → 10/02	B	NFU (TU5JP4)
1.6 16V	80	07/01 →	B	NFU (TU5JP4)

**Partner II, Tepee**

1.6	66	04/08 →	B	NFR (TU5JP4B)
	80	04/08 →	B	NFU (TU5JP4)
	72	08/10 →	B	5FK (EP6CB)
	88	04/10 →	B	5FS (EP6C)

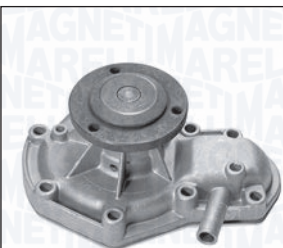
**81754**
**350981754000**

**FLANGIA**

Numero Fori Flangia	3
Dimensione Fori Flangia	M8×1.25
Posizione Attacco	74
Diametro Centraggio	Ø51
Diametro Girante	Ø69
N° Alette Girante	9
Posizione Girante	14.3

**KW**

**RENAULT**
**21, Station Wagon**

2.0 Turbo	119	02/90 → 10/92	B	J7R756	M →: F.209.863
	129	04/87 → 03/90	B	J7R752	M →: F.209.863
2.0 Turbo 4x4	129	08/89 → 10/93	B	J7R752	M →: F.209.863
	119	02/90 → 10/92	B	J7R756	M →: F.209.863

**25**

2.0	74	04/84 → 12/92	B	J6R706, J6R707, J6R760, J6R762, J6R763	M →: F.308.132
-----	----	---------------	---	--	----------------

**Master I**

28-35 2.0	58	10/86 → 07/98	B	J5R718	M →: F.029.329
	58	10/86 → 07/98	B	J5R728	M →: F.029.329

**81755**
**350981755000**

**FLANGIA**

Numero Fori Flangia	3
Dimensione Fori Flangia	M8×1.25
Posizione Attacco	63
Diametro Mozzo	M24×1.5 SX
Diametro Centraggio	Ø54
Diametro Girante	Ø69
N° Alette Girante	9
Posizione Girante	17

**KW**

**RENAULT**
**25**

2.1 Turbo-D FWD	63	04/84 → 12/92	D	J8S708, J8S738	M →: F.397.290
--------------------	----	---------------	---	-------------------	----------------

**81756**
**350981756000**

**PULEGGIA**

Diametro Puleggia	Ø147.2
Numero Denti/Gole Puleggia	6
Posizione Attacco	40
Diametro Girante	Ø67
N° Alette Girante	8
Posizione Girante	18

**KW**

**RENAULT**
**Rapid**

1.0	27	02/86 → 05/92	B	C1C706	(-)COP, (+)AC
1.1	33	07/85 → 04/95	B	C1E750, C1E752, C1E754, C1E756, C1E760, C1E762, C1E792	(-)COP, (+)AC
1.2	40	09/91 → 03/98	B	C3G710, C3G7 12	(-)COP, (+)AC
1.4	43	07/85 → 03/98	B	C1J768, C1J780, C3J700, C3J702, C3J760, C3J762	(-)COP, (+)AC
	44	03/86 → 08/91	B	C2J784	(-)COP, (+)AC

**Super 5**

1.1	33	01/86 → 03/95	B	C1E750, C1E752, C1E756, C1E760	(-)COP, (+)AC
	34	10/84 → 12/96	B	C1E750, C1E752, C1E754	(-)COP, (+)AC
1.2	40	01/87 → 08/90	B	C1G702, C1G720, C1G722	(-)COP, (+)AC
	44	01/87 → 12/96	B	C1G702	(-)COP, (+)AC
1.4	43	10/84 → 12/96	B	C1J768, C1J780, C3J700, C3J702, C3J760	(-)COP, (+)AC
	44	06/87 → 08/90	B	C2J784	(-)COP, (+)AC
1.4 Turbo	88	04/85 → 08/90	B	C1J782, C1J784, C1J788	(-)COP, (+)AC
1.4 Turbo GT	118	01/85 → 05/91	B	840730	(-)COP, (+)AC

81757

350981757000



**FLANGIA**  
 Numero Fori Flangia 3  
 Dimensione Fori Flangia M8x1.25  
 Posizione Attacco 71.6  
 Diametro Centraggio Ø51  
 Diametro Girante Ø68  
 N° Alette Girante 8  
 Posizione Girante 18.6



KW



RENAULT

Safrane I

2.1 dT	65	11/93 → 07/96	D	J8S760	→ M: 920.501, (-)AC
--------	----	---------------	---	--------	---------------------

81758

350981758000



**FLANGIA**  
 Numero Fori Flangia 3  
 Dimensione Fori Flangia M8x1.25  
 Posizione Attacco 73.3  
 Diametro Centraggio Ø51  
 Diametro Girante Ø68  
 N° Alette Girante 8  
 Posizione Girante 17.3



KW



RENAULT

Safrane I

2.1 dT	65	11/93 → 07/96	D	J8S760	M →: 920.502, (+)AC, (-)AC
--------	----	---------------	---	--------	----------------------------

81759

350981759000



**FLANGIA**  
 Numero Fori Flangia 3  
 Dimensione Fori Flangia M8x1.25  
 Posizione Attacco 74.5  
 Diametro Mozzo Ø30  
 Diametro Girante Ø68  
 N° Alette Girante 8  
 Posizione Girante 18.6



KW



RENAULT

Safrane I

2.0	77	11/92 → 07/96	B	J7R732, J7R733	
2.0 12V	97	04/92 → 07/96	B	J7R734, J7R735	
2.2	79	04/92 → 07/96	B	J7T762	
	101	04/92 → 07/96	B	J7T760, J7T761	

Safrane II

2.0 16V	100	07/96 → 12/00	B	N7Q710, N7Q711	
---------	-----	---------------	---	----------------	--

81760

350981760000



**FLANGIA**  
 Numero Fori Flangia 3  
 Dimensione Fori Flangia M8x1.25  
 Posizione Attacco 98.9  
 Diametro Centraggio Ø51  
 Diametro Girante Ø60  
 N° Alette Girante 8  
 Posizione Girante 20.5



KW



RENAULT

Laguna I, Grantour

2.2 D	61	11/93 → 03/01	D	G8T706, G8T752, G8T790, G8T794	
-------	----	---------------	---	--------------------------------	--



**81761**
**350981761000**

	<b>PULEGGIA</b>		
	Diametro Puleggia		Ø56.24
	Numero Denti/Gole Puleggia		19
	Altezza Puleggia		36
	Posizione Attacco		50.2
	Diametro Girante		Ø70
	N° Alette Girante		6
Posizione Girante		22.3	

**KW**

**RENAULT**
**Espace III**

2.2 12V TD	83	11/96 → 10/00	D	G8T714, G8T716, G8T760
2.2 D	84	11/97 → 01/00	D	G8T716

**Laguna I, Grandtour**

2.2 dT	83	03/96 → 03/01	D	G8T760
--------	----	---------------	---	--------

**Safrane II**

2.2 dT	83	07/96 → 12/00	D	G8T740
--------	----	---------------	---	--------

**81762**
**350981762000**

	<b>PULEGGIA</b>		
	Diametro Puleggia		Ø56.2
	Altezza Puleggia		26
	Posizione Attacco		52.6
	Diametro Girante		Ø60
	N° Alette Girante		6
	Posizione Girante		5

**KW**

**NISSAN**
**Kubistar**

1.2	44	08/03 → 10/09	B	D7F764
-----	----	---------------	---	--------

**RENAULT**
**Clio I**

1.2	40	01/96 → 09/98	B	D7F730
	43	01/96 → 09/98	B	D7F730

**Clio II**

1.1	43	09/98 →	B	D7F720, D7F726, D7F746
-----	----	---------	---	------------------------------

**81762**
**350981762000**

	<b>KW</b>				
--	-----------	--	--	--	--

**RENAULT**
**Clio II**

1.2	55	06/01 →	B	
	43	09/98 →	B	D7F720, D7F726, D7F746, D7F764, D7F766 → 12-2003
	44	03/99 → 05/01	B	D7F722
	44	03/99 → 10/03	B	D7F722, D7F726, D7F746

**Clio III, Grandtour**

1.2 16V	76	09/10 →	B	D4F786
---------	----	---------	---	--------

**1.2 Ethanol**

55	07/08 →			
----	---------	--	--	--

**Clio IV, Grandtour**

1.2 16V	54	11/12 →	B	D4F728, D4F740
	54	01/13 →	B	D4F740

**Kangoo I, Van**

1.2	43	08/97 →	B	D7F710, D7F720, D7F722, D7F726, D7F744, D7F746
	44	07/98 → 07/01	B	D7F764, D7F766
1.2 BiFuel	43	07/98 → 07/01	BF	D7F710, D7F744

**Twingo I**

1.2	44	09/98 → 08/00	B	D7F702, D7F703, D7F704
	40	05/96 →	B	D7F700, D7F701
	43	05/96 →	B	D7F700, D7F701, D7F702, D7F703, D7F704
1.2	43	05/96 →	B	D7F700, D7F701, D7F702, D7F703, D7F704, D7F706
	44	10/03 →		D7F702, D7F708

81764

350981764000



**PULEGGIA**

Diametro Puleggia	Ø131.8
Altezza Puleggia	25
Posizione Attacco	104.9
Diametro Girante	Ø70
N° Alette Girante	8
Posizione Girante	6.9



KW



**RENAULT**

**Safrane I**

3.0 Biturbo 4x4	193	02/93 → 07/96	B	Z7X726
3.0 V6	123	12/92 → 07/96	B	Z7X721, Z7X722, Z7X723, Z7X753
3.0 V6 4x4	123	12/92 → 07/96	B	Z7X721, Z7X722, Z7X723

**SAAB**

**9-3 I, Cabrio**

2.0 i	96	02/98 → 09/02	B	B204I
2.0 SE Turbo	147	02/98 → 09/02	B	B204R
2.0 Turbo	110	01/01 → 09/02	B	B205E
	113	10/98 → 09/02	B	B204E
	136	02/98 → 09/02	B	B204L, B205E, B205L
2.3	169	09/99 → 01/02	B	B235R
2.3 i	110	02/98 → 09/02	B	B234I
2.3 Turbo	165	10/98 → 09/02	B	B235R

**9-5 I, Station Wagon**

2.0 t	110	09/97 → 12/09	B	B205E
	136	07/00 → 12/09	B	B205L
	141	10/98 → 12/09	B	B204R
2.0 t Biopower	132	09/05 → 12/09		B205E
2.0 Turbo SE	141	10/98 → 07/00	B	B205E
2.3 t	125	09/97 → 12/09	B	B235E
	136	01/01 → 12/09	B	B235E

81764

350981764000



KW



**SAAB**

**9-5 I, Station Wagon**

2.3 Turbo	162	07/03 → 12/09	B	B235L
	169	10/99 → 09/01	B	B235R
	184	09/01 → 12/09	B	B235R
	191	11/05 → 12/09	B	B235R
	224	06/03 → 08/05	B	B235R

**900 II, Cabrio, Coupé**

2.0 -16 Turbo	136	07/93 → 02/98	B	B204L
2.0 i	96	08/94 → 02/98	B	B204I
	98	07/93 → 07/94	B	B206I
2.3 -16	110	07/93 → 02/98	B	B234I

81766

350981766000



**FLANGIA**

Numero Fori Flangia	4
Dimensione Fori Flangia	M6×1
Posizione Attacco	76.5
Diametro Mozzo	Ø28
Diametro Girante	Ø58
N° Alette Girante	7
Posizione Girante	10



KW



**TOYOTA**

**Carina E (T19), Station Wagon**

1.6	73	12/93 → 09/97	B	4A-FE	(+)COP, → 12-1994
	79	01/93 → 09/97	B	4A-FE	(+)COP, → 12-1994
	85	12/93 → 09/97	B	4A-FE	(+)COP, → 12-1994
1.6 GLI	79	04/92 → 09/97	B	4A-FE	(+)COP, → 12-1994

**Celica V**

1.6 STI	77	10/89 → 11/93	B	4A-FE	(+)COP
---------	----	---------------	---	-------	--------

**Corolla V, Liftback, Station Wagon, Compact**

1.6 GLI	84	07/92 → 04/97	B	4A-FE	(+)COP
1.6 Si	84	09/95 → 04/97	B	4A-FE	(+)COP

**Corolla VI, Liftback, Station Wagon, Compact**

1.6 Aut.	81	04/97 → 02/00	B	4A-FE	(+)COP
	79	04/97 → 02/00	B	4A-FE	(+)COP
	79	04/97 → 02/00	B	4A-FE	(+)COP

**81767 350981767000**

	<b>FLANGIA</b>	
	Numero Fori Flangia	4
	Dimensione Fori Flangia	M6x1
	Posizione Attacco	76.5
	Diametro Mozzo	Ø28
	Diametro Girante	Ø60
	N° Alette Girante	6
Posizione Girante	8	

**TOYOTA**
**Avensis I, Liftback, Station Wagon**

1.6	74	09/97 → 10/00	B	4A-FE	(+)COP
	81	09/97 → 10/00	B	4A-FE	(+)COP

**Carina E (T19), Station Wagon**

1.6	73	12/93 → 09/97	B	4A-FE	(+)COP, 01-1995 →
	73	01/95 → 09/97	B	4A-FE	(+)COP
	78	10/95 → 09/97	B	4A-FE	(+)COP
	79	01/93 → 09/97	B	4A-FE	(+)COP, 01-1995 →
1.6 16V	78	10/95 → 09/97	B	4A-FE	(+)COP
	85	12/94 → 09/97	B	4A-FE	(+)COP
1.6 GLI	79	04/92 → 09/97	B	4A-FE	(+)COP, 01-1995 →
1.6 i	73	02/95 → 09/97	B	4A-FE	(+)COP

**81768 350981768000**

	<b>FLANGIA</b>	
	Numero Fori Flangia	4
	Dimensione Fori Flangia	M6x1
	Posizione Attacco	76.5
	Diametro Mozzo	Ø28
	Diametro Girante	Ø60
	N° Alette Girante	6
Posizione Girante	8	

**TOYOTA**
**Avensis I, Liftback, Station Wagon**

1.8	81	09/97 → 10/00	B	7A-FE	(+)COP, OEM: SEM
-----	----	---------------	---	-------	------------------

**81768 350981768000**

**TOYOTA**
**Carina E (T19), Station Wagon**

1.8	85	04/92 → 09/97	B	7A-FE	(+)COP, 01-1995 →, → 12-1995
	79	01/95 → 09/97	B	7A-FE	(+)COP, → 12-1995
1.8 GL	92	10/94 → 09/97	B	7A-FE	(+)COP, → 12-1995
1.8 i	79	02/95 → 09/97	B	7A-FE	(+)COP
1.8 i 16V	79	01/95 → 09/97	B	7A-FE	(+)COP, → 12-1995

**81769 350981769000**

	<b>FLANGIA</b>	
	Numero Fori Flangia	4
	Dimensione Fori Flangia	M6x1
	Posizione Attacco	76.5
	Diametro Mozzo	Ø28
	Diametro Girante	Ø58
	N° Alette Girante	7
Posizione Girante	10	

**TOYOTA**
**Avensis I, Liftback, Station Wagon**

1.8	81	09/97 → 10/00	B	7A-FE	(+)COP, OEM: AISIN
-----	----	---------------	---	-------	--------------------

**Carina E (T19), Station Wagon**

1.8	85	04/92 → 09/97	B	7A-FE	(+)COP, 01-1996 →
	79	01/95 → 09/97	B	7A-FE	(+)COP, 01-1996 →
1.8 GL	92	10/94 → 09/97	B	7A-FE	(+)COP, 01-1996 →
1.8 i 16V	79	01/95 → 09/97	B	7A-FE	(+)COP, 01-1996 →

**Celica VI**

1.8 i 16V	85	11/93 → 11/99	B	7A-FE	(+)COP
-----------	----	---------------	---	-------	--------

**Corolla V, Liftback, Station Wagon, Compact**

1.8 16V 4WD	81	09/95 → 04/97	B	7A-FE	(+)COP
1.8 GT	86	11/92 → 05/95	B	7A-FE	(+)COP

**Corolla VI, Liftback, Station Wagon, Compact**

1.8	81	10/97 → 10/01	B	7A-FE	(+)COP
1.8 4WD	81	04/97 → 10/01	B	7A-FE	(+)COP

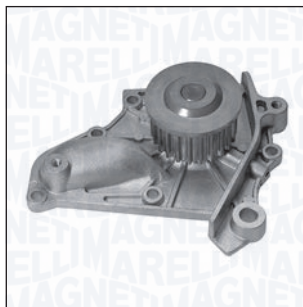
**81770**
**350981770000**

**PULEGGIA**

Diametro Puleggia	Ø56.8
Numero Denti/Gole Puleggia	23
Altezza Puleggia	29
Posizione Attacco	48
Diametro Girante	Ø67
N° Alette Girante	8
Posizione Girante	17

**KW**

**TOYOTA**
**Avensis I, Liftback, Station Wagon**

2.0	94	09/97 → 10/00	B	3S-FE	(-)COP, 01-1997 →
-----	----	---------------	---	-------	----------------------

**Camry I, Liftback, Station Wagon**

2.0	94	11/86 → 05/91	B	3S-FE	(-)COP
2.0 Gli 16V	89	11/86 → 05/91	B	3S-FE	(-)COP

**Camry II, Liftback, Station Wagon**

2.2	100	06/91 → 08/96	B	5S-FE	(-)COP
-----	-----	---------------	---	-------	--------

**Camry III, Station Wagon**

2.2	93	11/00 → 11/01	B	5S-FE	(-)COP
	96	08/96 → 11/01	B	5S-FE	(-)COP, 01-1993 →

**Carina E (T19), Station Wagon**

1.8	85	04/92 → 09/97	B	7A-FE	(-)COP, → 12-1994
2.0	98	01/93 → 09/97	B	3S-FE	(-)COP
2.0 GLI	98	04/92 → 09/97	B	3S-FE	(-)COP
2.0 GTi	116	04/92 → 02/94	B	3S-GE	(-)COP
2.0 GTi 16V	129	03/94 → 09/97	B	3S-GE	(-)COP
2.0 i	93	12/93 → 09/97	B	3S-FE	(-)COP

**Picnic I**

2.0	90	01/01 → 12/01	B	3S-FE	(-)COP
2.0 16V	94	05/96 → 12/01	B	3S-FE	(-)COP

**RAV 4 I**

2.0 16V 4WD	94	12/97 → 06/00	B	3S-FE	(-)COP
2.0 4WD	95	06/94 → 06/00	B	3S-FE	(-)COP

**81771**
**350981771000**

**PULEGGIA**

Diametro Puleggia	Ø102
Numero Denti/Gole Puleggia	4
Posizione Attacco	70.6
Diametro Girante	Ø55
N° Alette Girante	7
Posizione Girante	16.3

**KW**

**TOYOTA**
**Carina E (T19), Station Wagon**

1.5 SG	77	04/92 → 09/97	B	5A-FE	(-)COP
--------	----	---------------	---	-------	--------

**Corolla V, Liftback, Station Wagon, Compact**

1.3 XLI	55	09/95 → 04/97	B	4E-FE	(-)COP
	65	07/92 → 04/97	B	4E-FE	(-)COP
1.3 XLI 16V	65	07/92 → 09/95	B	4E-FE	(-)COP

**Corolla VI, Liftback, Station Wagon, Compact**

1.3	55	05/97 → 10/01	B	2E	(-)COP
1.4	63	04/97 → 02/00	B	4E-FE	(-)COP

**Paseo II**

1.5	66	10/96 → 01/98	B	5E-FE	(-)COP
1.5 16V	66	08/95 → 07/99	B	5E-FE	(-)COP

**Starlet IV**

1.3	55	04/96 → 03/99	B	4E-FE	(-)COP
-----	----	---------------	---	-------	--------

**81772**
**350981772000**

**PULEGGIA**

Diametro Puleggia	Ø53.05
Numero Denti/Gole Puleggia	18
Altezza Puleggia	28
Posizione Attacco	60.4
Diametro Girante	Ø72
N° Alette Girante	7
Posizione Girante	33

**KW**

**VOLKSWAGEN**
**Transporter IV**

2.4 D	57	07/90 → 04/98	D	AAB	09-1990 →, → 07-1995, T →: F70-N.014.000
	57	09/90 → 04/98	D	AAB	→ 07-1995, → T: F70-N-014.000

**81772 350981772000**

**VOLKSWAGEN**
**Transporter IV**

2.4 D Syncro	57	10/92 → 09/98	D	AAB	09-1990 →, → 07-1995, T →: F70.N.014.000
2.5	81	11/90 → 04/03	B	AAF, ACU, AEN, AEU	→ T: F70.N.014.000
2.5 Syncro	81	11/92 → 04/03	B	AAF, ACU, AEN, AEU	→ T: F70.N.014.000

**81773 350981773000**



**FLANGIA**

Numero Fori Flangia 3

Dimensione Fori Flangia M8×1.25

Posizione Attacco 31.6

Diametro Mozzo Ø30

Diametro Girante Ø65

N° Alette Girante 8

Posizione Girante 63

**FORD**
**Galaxy I**

2.8 i V6	128	11/95 → 04/00	B	AAA, AMY
2.8 i V6 4x4	128	04/96 → 04/00	B	AAA, AMY
2.8 V6	150	04/00 → 05/06	B	AYL

**MERCEDES-BENZ**
**Classe V**

V 280	128	08/97 → 07/03	B	M104.900
-------	-----	---------------	---	----------

**SEAT**
**Leon I**

2.8 Cupra 4	150	02/01 → 06/06	B	AUE	→ 09-2001
-------------	-----	---------------	---	-----	-----------

**VOLKSWAGEN**
**Bora, Station Wagon**

2.8 V6 4motion	150	03/99 → 05/05	B	AQP, AUE, BDE	M: AUE, M: AQP
-------------------	-----	---------------	---	------------------	----------------

**Corrado**

2.9 VR6	140	08/91 → 12/95	B	ABV
---------	-----	---------------	---	-----

**Golf III, Variant, Cabrio**

2.8 VR6	128	01/92 → 08/97	B	AAA	
2.9 VR6	140	10/94 → 04/99	B	ABV	01-1993 →
Syncro	140	10/94 → 08/97	B	ABV	01-1993 →

**Golf IV, Variant, Cabrio**

2.8 V6 4motion	150	03/99 → 06/05	B	AQP, AUE, BDE
-------------------	-----	---------------	---	------------------

**81773 350981773000**

**VOLKSWAGEN**
**Passat III, Variant**

2.8 VR6	128	06/91 → 08/96	B	AAA
2.9 VR6 Syncro	135	01/94 → 05/97	B	ABV

**Sharan I**

2.8 V6 24V	150	04/00 → 03/10	B	AYL	→ T: 035.000
2.8 V6 24V 4motion	150	04/00 → 03/10	B	AYL	→ T: 035.000
2.8 VR6	128	09/95 → 04/00	B	AAA, AMY	09-1995 →
2.8 VR6 Syncro	128	11/96 → 04/00	B	AAA, AMY	09-1995 →

**Transporter IV**

2.8	103	05/96 → 05/00	B	AES
2.8 VR 6	103	11/95 → 04/00	B	AES
2.8 VR6	150	04/00 → 04/03	B	AMV
2.8 VR6 Syncro	103	01/96 → 04/96	B	AES

**Vento**

2.8 VR6	120	08/95 → 04/96	B	AAA
2.8 VR6	128	01/92 → 09/98	B	AAA

**81774 350981774000**



**FLANGIA**

Numero Fori Flangia 4

Dimensione Fori Flangia M6×1

Posizione Attacco 80

Diametro Mozzo M30×1.5 SX

Diametro Centraggio Ø35

Diametro Girante Ø76

N° Alette Girante 4

Posizione Girante 15.4

**MERCEDES-BENZ**
**Sprinter I (901, 902, 903, 904)**

208 D	58	02/95 → 04/00	D	OM601.943	01-1996 →
	60	10/96 → 04/00	D	OM601.943	01-1996 →
214	105	02/95 → 05/06	B	M111.979, M111.984	01-1996 →
214 NGT	92	04/00 → 05/06		M111.984	
308 D	58	02/95 → 04/00	D	OM601.943	01-1996 →
308 D 2.3	58	02/95 → 04/00	D	OM601.943	01-1996 →
	60	11/96 → 04/00	D	OM601.943	01-1996 →
314	105	02/95 → 05/06	B	M111.979, M111.984	01-1996 →
	105	02/95 → 05/06	B	M111.984	01-1996 →

**81774 350981774000**



**MERCEDES-BENZ**

**Sprinter I (901, 902, 903, 904)**

314 4x4	105	08/02 → 05/06	B	M111.984	
314 NGT	92	04/00 → 05/06		M111.984	
	92	04/00 → 05/06			
408 D	58	02/96 → 05/06	D	OM601.943	01-1996 →
414	105	02/96 → 05/06	B	M111.979, M111.984	01-1996 →
	105	02/96 → 05/06	B	M111.979, M111.984	
414 4x4	105	05/97 → 05/06	B	M111.979, M111.984	01-1996 →

**VOLKSWAGEN**

**LT II 28-35, 28-46**

2.3	105	05/96 → 07/06	B	AGL	
-----	-----	---------------	---	-----	--

**81775 350981775000**



**PULEGGIA**

Diametro Puleggia Ø67.3

Numero Denti/Gole Puleggia 27

Altezza Puleggia 20.7

Posizione Attacco 50.8

Diametro Girante Ø63.6

N° Alette Girante 8

Posizione Girante 41



**SEAT**

**Arosa**

1.0	37	05/97 → 06/04	B	AER, ALD, ALL, ANV, AUC	M: ALD, M: AER, M: ALL, M: ALD, M: AUC, M: AER
1.4	44	05/97 → 06/04	B	AEX, AKK, AKV, ANW, APQ, AUD	12-1999 → , M: AUD, M: ANW, M: AUD

**Cordoba I, Vario**

1.0 i	37	09/96 → 06/99	B	AER	
-------	----	---------------	---	-----	--

**Cordoba II, Vario**

1.0	37	06/99 → 10/02	B	ALD, ANV, AUC	
1.4	44	06/99 → 10/02	B	AKK, ANW, AUD	

**Ibiza II**

1.0 i	37	09/96 → 08/99	B	AER	
-------	----	---------------	---	-----	--

**81775 350981775000**



**SEAT**

**Ibiza III**

1.0	37	08/99 → 02/02	B	ALD, ANV, AUC	
1.4	44	08/99 → 02/02	B	AKK, ANW, AUD	

**VOLKSWAGEN**

**Lupo I**

1.0	37	09/98 → 07/05	B	AER, ALD, ALL, ANV, AUC	M: ALD, M: AUD, M: AUC, M: ALD, M: AER, M: AUC, M: ALL, M: AER, M: AUD, M: AUC, M: ANV, M: ALL, M: ALD, M: AER
1.4	44	10/00 → 07/05	B	AUD	

**Polo III (6N1), Classic, Variant, Van**

1.4	40	12/98 → 09/01	B	AKP	
	44	05/97 → 09/01	B	AEX, AKK, AKV, ANW, APQ, AUD	M: AKK, M: AUD, M: ANW, M: AKK
50 1.0	37	09/96 → 10/99	B	AER, ALL	
60 1.4	44	12/95 → 09/01	B	AEX, AKK, AKV, ANW, APQ, AUD	M: AUD, M: AKK, M: ANW, M: AUD

**Polo IV (6N2)**

1.0	37	10/99 → 09/01	B	ALD, AUC	
1.4	40	10/99 → 09/01	B	AKP, ANX	
	44	10/99 → 09/01	B	AKK, AUD	

**81776 350981776000**



**PULEGGIA**

Diametro Puleggia Ø67.3

Numero Denti/Gole Puleggia 27

Altezza Puleggia 27

Posizione Attacco 56.8

Diametro Girante Ø63.6

N° Alette Girante 8

Posizione Girante 40.5



**SEAT**

**Cordoba I, Vario**

1.4 i 16V	74	09/96 → 06/99	B	AFH	
-----------	----	---------------	---	-----	--

**Ibiza III**

1.0 16V	51	10/99 → 02/02	B	AST, AVZ	
---------	----	---------------	---	----------	--

**81776 350981776000**

**VOLKSWAGEN**
**Polo III (6N1), Classic, Variant, Van**

100 1.4 16V	74	04/96 → 10/99	B	AFH
-------------	----	---------------	---	-----

**81777 350981777000**

**PULEGGIA**

Diametro Puleggia	Ø67.3
Numero Denti/Gole Puleggia	27
Altezza Puleggia	21
Posizione Attacco	55.4
Diametro Girante	Ø63.6
N° Alette Girante	8
Posizione Girante	41

**AUDI**
**A2**

1.4	55	02/00 → 08/05	B	AUA, BBY
-----	----	---------------	---	----------

**SEAT**
**Altea, Altea XL**

1.4 16V	63	05/06 →	B	BXW, CGGB
---------	----	---------	---	-----------

**Arosa**

1.4 16V	74	01/00 → 06/04	B	AFK, AQQ, AUB
---------	----	---------------	---	---------------

**Cordoba II, Vario**

1.4 16V	55	05/00 → 10/02	B	APE, AUA
	74	02/00 → 10/02	B	AQQ, AUB

**Cordoba III, Vario**

1.4 16V	55	09/02 → 12/07	B	BBY, BKY
	63	05/06 → 11/09	B	BXW
	74	10/02 → 11/09	B	AUB, BBZ

**Ibiza III**

1.4 16V	55	05/00 → 02/02	B	APE, AUA
	74	08/99 → 02/02	B	AQQ, AUB

**Ibiza IV**

1.4 16V	55	02/02 → 12/07	B	BBY, BKY
	63	05/06 → 11/09	B	BXW
	74	02/02 → 11/09	B	AUB, BBZ

**Ibiza V**

1.4	63	03/08 →	B	BXW, CGGB
	63	03/10 →	B	CGGB
1.6	77	05/08 →	B	BTS T →: 6J9002801
	77	02/12 →	B	BTS
1.6 LPG	60	05/11 →		CNKA

**81777 350981777000**

**SEAT**
**Inca**

1.4 16V	55	04/00 → 06/03	B	AUA
---------	----	---------------	---	-----

**Leon I**

1.4 16V	55	11/99 → 06/06	B	AHW, APE, AUA, AXP, BCA
---------	----	---------------	---	-------------------------

**Leon II**

1.4 16V	63	06/06 → 12/12	B	BXW, CGGB
---------	----	---------------	---	-----------

**Toledo II**

1.4 16V	55	01/00 → 05/02	B	AHW, APE, AUA, AXP, BCA
---------	----	---------------	---	-------------------------

**SKODA**
**Fabia I, Station Wagon, Van**

1.4 16V	55	12/99 → 03/08	B	AUA, BBY, BKY
	59	04/06 → 12/07	B	BUD
	74	12/99 → 03/08	B	AUB, BBZ
	74	04/00 → 12/07	B	AUB, BBZ

**Fabia II, Station Wagon, Van**

1.4	63	01/07 → 12/14	B	BXW, CGGB
-----	----	---------------	---	-----------

**Octavia I, Station Wagon**

1.4 16V	55	09/00 → 12/10	B	AXP, BCA
---------	----	---------------	---	----------

**Octavia II, Station Wagon**

1.4	55	05/04 → 05/06	B	BCA
	59	06/04 → 04/13	B	BUD, CGGA

**Roomster, Van**

1.4	63	09/06 → 05/15	B	BXW, CGGB
-----	----	---------------	---	-----------

**VOLKSWAGEN**
**Bora, Station Wagon**

1.4 16V	55	03/00 → 05/05	B	AHW, AKQ, APE, AXP, BCA 04-1998 →
	55	09/01 → 05/05	B	AHW, AXP, BCA

**Caddy II**

1.4	55	08/00 → 01/04	B	AUA
1.4 16V	55	08/00 → 01/04	B	AUA

**Caddy III**

1.4	55	03/04 → 05/06	B	BCA
	59	05/06 → 08/10	B	BUD

**81777**
**350981777000**

**KW**

**VOLKSWAGEN**
**Golf IV, Variant, Cabrio**

1.4 16V	55	08/97 → 06/05	B	AHW, AKQ, APE, AXP, BCA	
	55	05/99 → 06/06	B	AHW, AKQ, APE, AXP, BCA	01-1997 →

**Golf V, Plus, Variant**

1.4	59	06/07 → 07/09	B	BUD	
	55	01/05 → 11/06	B	BCA	
1.4 16V	59	05/06 → 11/08	B	BUD	
	59	05/06 → 12/13	B	BUD, CGGA	

**Golf VI, Variant, Cabrio**

1.4	59	07/09 → 07/13	B	BUD, CGGA	
	59	10/08 → 11/12	B	CGGA	

**Lupo I**

1.4 16V	55	09/98 → 07/05	B	AHW, AKQ, APE, AUA, BBY	11-1998 →
	74	08/99 → 07/05	B	AFK, AQQ, AUB	
1.4 FSI	77	02/01 → 07/05	B	ARR	

**New Beetle, Cabrio**

1.4	55	11/01 → 09/10	B	BCA	
-----	----	---------------	---	-----	--

**Polo III (6N1), Classic, Variant, Van**

1.4 16V	55	10/99 → 09/01	B	APE, AUA	
75 1.4 16V	55	10/99 → 09/01	B	APE, AUA	

**Polo IV (6N2)**

1.4 16V	55	10/99 → 09/01	B	AHW, APE, AUA	
	74	10/99 → 09/01	B	AFK, AQQ, AUB	

**Polo V (9N)**

1.4	55	07/03 →	B	BBY, BKY	
	63	06/05 → 11/09	B		
	74	11/03 →	B	BBZ	
1.4 16V	55	10/01 → 05/08	B	AUA, BBY, BKY	
	59	05/06 → 11/09	B	BUD	
	74	10/01 → 05/08	B	AUB, BBZ	

**Polo VI (6R)**

1.4	63	06/09 →	B	CDDA, CGGB, CLPA	
1.4 BiFuel	60	03/10 → 01/11	BF	CMAA	

**81777**
**350981777000**

**KW**

**VOLKSWAGEN**
**Polo VI (6R)**

1.6	63	11/10 →	B	CFNB	
1.6 BiFuel	60	01/11 →	BF	CNKA	

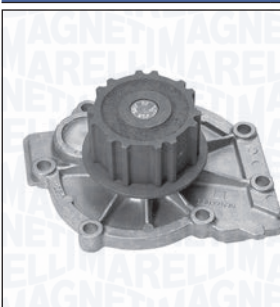
**81779**
**350981779000**

**PULEGGIA**

Diametro Puleggia	Ø62.3
Numero Denti/Gole Puleggia	14
Altezza Puleggia	31.5
Posizione Attacco	59.1
Diametro Girante	Ø71
N° Alette Girante	7
Posizione Girante	21

**KW**

**VOLVO**
**S 80 I**

2.8 T6	200	05/98 → 07/06	B	B6284T	→ 12-2002
	147	03/99 → 07/06	B	B6294S	→ 12-2002
2.9	150	05/98 → 07/06	B	B6304S3	→ 12-2002
	144	06/01 → 07/06	B	B6294S2	→ 12-2002
3.0 T6	200	06/01 → 07/06	B	B6294T	→ 12-2002

**81780**
**350981780000**

**PULEGGIA**

Diametro Puleggia	Ø56.3
Numero Denti/Gole Puleggia	19
Altezza Puleggia	29.5
Posizione Attacco	68
Diametro Girante	Ø55
N° Alette Girante	11
Posizione Girante	35.6

**KW**

**DAEWOO**
**Espero**

1.5 16V	65	10/93 → 09/94	B	A15MF	
	66	02/95 → 06/99	B	A15MF	

**Lanos**

1.6 16V	78	05/97 →	B	A16DMS	
---------	----	---------	---	--------	--

**Nexia I**

1.5 16V	66	02/95 → 08/97	B	A15MF	
---------	----	---------------	---	-------	--

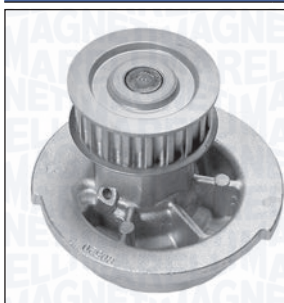

**81781**
**350981781000**

**PULEGGIA**

Diametro Puleggia	Ø56.3
Numero Denti/Gole Puleggia	19
Altezza Puleggia	20
Posizione Attacco	58.5
Diametro Girante	Ø55
N° Alette Girante	11
Posizione Girante	35.6

**KW**

**CHEVROLET**
**Aveo I**

1.5	62	01/05 → 05/08	B	F15S3	
	62	05/05 →	B	F15S3, LX6	

**Kalos**

1.2	53	03/05 →	B	B12S1	
-----	----	---------	---	-------	--

**DAEWOO**
**Kalos**

1.2	53	04/03 →	B	B12S1, F12S3	
1.4	61	09/02 →	B	F14S3	
1.5	62	11/02 → 12/04	B	F15S	

**Lanos**

1.4	55	05/97 →	B	A14SMS	
1.5	63	05/97 →	B	A15SMS	01-1997 →
	63	05/97 →	B	A15SMS	

**81782**
**350981782000**

**PULEGGIA**

Diametro Puleggia	Ø56.3
Numero Denti/Gole Puleggia	19
Altezza Puleggia	29.5
Posizione Attacco	68
Diametro Girante	Ø55
N° Alette Girante	11
Posizione Girante	35.6

**KW**

**CHEVROLET**
**Aveo I**

1.6	77	09/03 →	B	A16DMS, LXT, LXV	
-----	----	---------	---	---------------------	--

**Cruze II, Hatchback, Station Wagon**

1.6	86	12/12 →	B	LDE	
-----	----	---------	---	-----	--

**Kalos**

1.4	61	03/05 →	B	F14S3	
1.4 16V	69	03/05 →	B	F14D3	

**81782**
**350981782000**

**KW**

**CHEVROLET**
**Lacetti**

1.4 16V	70	03/05 →	B	F14D3	
1.6	80	03/05 →	B	F16D3	
1.8	89	08/05 →	B	F18D3	
	90	03/05 →	B	T18SED	

**Nubira, Station Wagon**

1.4	69	01/05 →	B	F14D3	
	70	01/06 →	B	F14D3	
1.6	80	03/05 →	B	F16D3	
1.8	89	08/05 →	B	F18D3	
	90	03/05 →	B	T18SED	

**Rezzo**

1.6	77	03/05 →	B	A16DMS	
	79	08/05 →	B	A16DMS	

**DAEWOO**
**Kalos**

1.4	69	05/03 → 12/04	B	F14D3	
1.4 16V	69	04/03 →	B	F14D3	

**Lacetti II**

1.6	78	06/99 → 07/03	B	A16DMS	
-----	----	---------------	---	--------	--

**Lacetti III, Hatchback**

1.4	70	02/04 →	B	F14D3	
1.6	80	02/04 →	B	F16D3	

**Nubira I, Station Wagon**

1.6	76	08/02 → 07/03	B	A16DMS	
	66	06/97 →	B	A16SMS	
1.6 16V	76	07/00 →	B	A16DMS	
	78	05/97 →	B	A16DMS	

**Nubira II, Station Wagon**

1.4	69	10/03 → 12/04	B	F14D3	
1.6	80	07/03 →	B	F16D3	
1.8	90	07/03 →	B	T18SED	

**Rezzo**

1.6	77	09/00 →	B	A16DMS	
1.6 SX	66	08/01 → 12/04	B	A16SMS	

**81783**
**350981783000**

**PULEGGIA**

Diametro Puleggia	Ø54.66
Numero Denti/Gole Puleggia	22
Altezza Puleggia	28
Posizione Attacco	58.9
Diametro Girante	Ø58
N° Alette Girante	7
Posizione Girante	3.75

**CHEVROLET**
**Aveo I**

1.2	53	03/06 → 12/07	B	B12S1, F12S3, LY4
-----	----	---------------	---	----------------------

**Kalos**

1.2	53	03/05 →	B	F12S3
-----	----	---------	---	-------

**Matiz**

0.8	38	03/05 →	B	F8CV
0.8 LPG	38	03/05 →		F8CV
1.0	47	03/05 →	B	B10S
	49	03/05 →	B	B10S1
1.0 LPG	49	03/05 →		B10S1

**Spark I**

0.8	38	09/00 → 12/04	B	F8CV
1.0	47	11/02 → 12/04	B	G10CV

**Spark II**

0.8	37	05/05 →	B	F8CV
1.0 SX	46	05/05 →	B	B10S, LA2
	49	05/05 →	B	B10S1

**DAEWOO**
**Matiz**

0.8	38	09/98 →	B	F8CV
1.0	47	01/03 →	B	B10S

**Tico II**

0.8	35	02/95 → 12/00	B	F8C
	38	01/96 → 12/00	B	F8CV

**SUZUKI**
**Cappucino**

0.7	47	02/92 → 08/95	B	F6A
-----	----	---------------	---	-----

**81784**
**350981784000**

**FLANGIA**

Numero Fori Flangia	4
Dimensione Fori Flangia	M6×1
Posizione Attacco	92.5
Diametro Mozzo	Ø20
Diametro Girante	Ø54.5
N° Alette Girante	6
Posizione Girante	-1

**HYUNDAI**
**Accent I**

1.3	44	10/94 → 01/00	B	G4EH
	55	10/94 → 01/00	B	G4EH
1.3 i 12V	62	10/94 → 01/00	B	G4EH
1.5 i 12V	65	10/94 → 01/00	B	G4EK

**Accent II**

1.3	55	01/00 → 11/05	B	G4EA
	61	01/00 → 11/05	B	G4EA
	62	08/02 → 11/05	B	G4EH
	63	01/00 → 11/05	B	G4EA

**Getz**

1.3	63	09/03 → 09/05	B	G4EA
1.3 i	60	09/02 → 03/04	B	G4EA

**Lantra I**

1.5 i.e.	63	10/90 → 11/95	B	G15B, G4DJ
----------	----	---------------	---	------------

**Lantra II, Station Wagon**

1.5 12V	65	12/96 → 09/00	B	G4EK
---------	----	---------------	---	------

**Pony III / Excel**

1.3	43	10/89 → 01/95	B	G4DG
	49	10/89 → 01/95	B	G4DG
1.5	53	10/89 → 01/95	B	G15B, G4DJ
1.5 i	61	10/89 → 01/95	B	G15B, G4DJ
	62	10/89 → 01/95	B	G15B, G4DJ

**S Coupé**

1.5 GS	57	03/90 → 12/92	B	G4DJ
1.5 i	62	02/90 → 05/96	B	G15B, G4DJ
	65	04/92 → 05/96	B	G4EK
	85	04/91 → 05/96	B	G4EK-TC

**MITSUBISHI**
**Colt III**

1.3	51	04/88 → 05/92	B	4G13 (8V)
1.3 12V	55	04/88 → 05/92	B	4G13 (12V)
1.3 GL	44	04/88 → 12/90	B	4G13 (8V)
1.5	66	07/90 → 05/92	B	4G15 (12V)
1.5 GLXi	62	04/88 → 05/92	B	4G15

**Colt IV**

1.3 GLi 12V	55	04/92 → 04/96	B	4G13 (12V)
-------------	----	---------------	---	------------

**81784** **350981784000**

**MITSUBISHI**
**Colt V**

1.5 16V 69 10/99 → 09/03 B 4G15 (16V)

**Lancer III, Station Wagon**

1.3 GL 50 05/88 → 06/90 B G13B

55 07/90 → 08/92 B 4G13 (12V)

1.5 61 09/88 → 12/90 B 4G15

1.5 12V 66 09/90 → 12/91 B 4G15 (12V)

1.5 GLS 63 08/89 → 08/92 B 4G15 (12V)

**Lancer IV, Station Wagon**

1.2 GL 44 05/88 → 08/92 B 4G16

44 04/88 → 05/92 B 4G13 (8V)

1.3 51 08/88 → 05/92 B 4G13 (8V), G13B

1.3 12V 55 06/92 → 05/94 B 4G13 (12V)

1.3 GL 50 05/88 → 06/90 B G13B

1.5 62 06/88 → 05/92 B 4G15

62 04/88 → 05/92 B 4G15 (12V)

1.5 12V 66 05/89 → 05/92 B 4G15 (12V)

1.5 GLS 63 08/89 → 08/92 B 4G15 (12V)

**Lancer V, Station Wagon, Hatchback, Coupé**

1.3 55 06/92 → 02/95 B 4G13 (12V)

55 06/92 → 12/96 B 4G13 (12V)

1.3 55 06/92 → 12/96 B 4G13 (12V)

**Lancer VI, Station Wagon, Hatchback, Coupé, Cabrio**

1.5 16V 69 10/99 → 08/03 B 4G15 (16V)

**Space Star**

1.3 16V 60 09/00 → 12/04 B 4G13 (16V)

61 12/98 → 12/04 B 4G13 (16V)

63 06/98 → 12/04 B 4G13 (16V)

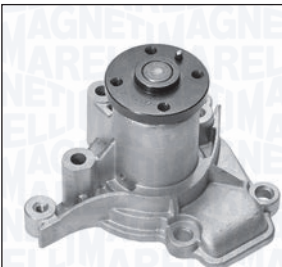
**81785** **350981785000**

**FLANGIA**

Numero Fori Flangia	4
Dimensione Fori Flangia	M6×1
Posizione Attacco	86.5
Diametro Mozzo	Ø23.9
Diametro Girante	Ø63
N° Alette Girante	6
Posizione Girante	6

**HYUNDAI**
**Coupé I**

1.6 16V 85 03/98 → 04/02 B G4GR

1.6 i 16V 84 12/96 → 04/02 B 4G61

100 08/01 → 08/09 B G4GC-G

2.0 101 08/99 → 01/02 B G4DF

102 03/02 → 08/09 B G4GC-G

2.0 16V 99 03/01 → 04/02 B G4DF

102 08/96 → 04/02 B G4GF

2.0 GLS 105 02/03 → 08/09 B G4GC-G

**Elantra I**

1.8 79 06/00 → 07/03 B G4BB

97 06/00 → 07/06 B G4BB

102 06/00 → 07/06 B G4GC-G

2.0 104 06/00 → 07/06 B G4GC

105 10/03 → 07/06 B G4GC

**Elantra II**

2.0 CVVT 105 06/06 → 06/11 B G4GC 11-2006 →

**i30 I, Station Wagon**

2.0 105 10/07 → 11/11 B G4GC, G4GC-G

2.0 105 10/07 → 11/11 B G4GC, G4GC-G

**Lantra I**

1.6 i.e. 16V 78 10/90 → 11/95 B G4CR

84 10/90 → 11/95 B G4CR

**Lantra II, Station Wagon**

1.6 16V 84 11/95 → 09/00 B 4G61

1.6 i 66 11/95 → 09/00 B G4GR

1.8 16V 94 11/95 → 09/00 B G4GM

2.0 16V 102 08/96 → 09/00 B G4GF

**Matrix**

1.8 90 06/01 → 08/10 B G4GB-G

**Tiburon**

2.0 CVVT 105 10/06 → 12/08 B G4GC

**Trajjet**

2.0 103 01/04 → 07/08 B G4GC-G

104 11/03 → 07/08 B G4GC 02-2004 →

**81785 350981785000**



**HYUNDAI**

**Tucson I**

2.0	104	08/04 → 03/10	B	G4GC
2.0 Trazione integrale	104	08/04 → 03/10	B	G4GC

**KIA**

**Carens II**

2.0 CVVT	102	08/04 →	B	G4GC
----------	-----	---------	---	------

**Cee'd I, Station Wagon**

2.0	105	12/06 → 12/12	B	G4GC
-----	-----	---------------	---	------

**Cerato I**

2.0	105	04/04 →	B	G4GC
-----	-----	---------	---	------

**Pro Cee'd I**

2.0	105	02/08 → 09/12	B	G4GC
2.0 LPG	105	01/09 → 12/09		G4GC

**Sportage II**

2.0 16V 4WD	104	09/04 →	B	G4GC
2.0 i 16V	104	09/04 →	B	G4GC

**81786 350981786000**



**FLANGIA**  
 Numero Fori Flangia 4  
 Dimensione Fori Flangia M6×1  
 Posizione Attacco 92  
 Diametro Mozzo Ø23.9  
 Diametro Girante Ø75  
 N° Alette Girante 8  
 Posizione Girante -1



**HYUNDAI**

**Lantra I**

1.8 i.e. 16V	93	10/90 → 11/95	B	G4CN
--------------	----	---------------	---	------

**Sonata II**

2.0 i 16V	96	01/91 → 10/93	B	G4CP-D
-----------	----	---------------	---	--------

**Sonata III**

2.0 i 16V	92	06/96 → 06/98	B	G4CP-DM
	102	05/93 → 06/98	B	G4CP-D

**KIA**

**Joice**

2.0	88	09/01 →	B	G4CP
	102	02/00 →	B	G4CP

**81786 350981786000**



**MITSUBISHI**

**Colt III**

1.8 GTi 16V	100	06/90 → 05/92	B	4G67
-------------	-----	---------------	---	------

**Eclipse I, Cabrio**

2.0 i 16V	110	04/91 → 11/95	B	4G63 (DOHC16V)
2.0 i 16V 4WD	110	04/91 → 11/95	B	4G63 (DOHC16V)

**Galant IV, Station Wagon**

2.0 GTi 16V	106	11/88 → 10/92	B	4G63 (DOHC16V)
	107	11/88 → 10/92	B	4G63 (DOHC16V)
2.0 GTi 16V 4WD	106	06/88 → 10/92	B	4G63 (DOHC16V)
	110	09/91 → 10/92	B	4G63 (DOHC16V)
2.0 GTi 16V 4x4	106	07/89 → 12/92	B	4G63 (DOHC16V)

**Lancer IV, Station Wagon**

1.8 GTi 16V	100	11/89 → 05/92	B	4G67
-------------	-----	---------------	---	------

**Santamo**

2.0 16V	102	05/99 → 12/04	B	4G63 (DOHC16V)
2.0 16V 4WD	102	05/99 → 12/04	B	4G63 (DOHC16V)

**81787 350981787000**



**FLANGIA**  
 Numero Fori Flangia 4  
 Dimensione Fori Flangia M6×1  
 Posizione Attacco 130  
 Diametro Mozzo Ø23.9  
 Diametro Girante n.v.  
 N° Alette Girante n.v.  
 Posizione Girante n.v.



**HYUNDAI**

**Galloper I**

2.5 Tci D	77	08/98 → 12/03	D	D4BH
	65	08/98 → 12/03	D	D4BA
2.5 TD	62	08/91 → 07/98	D	4D56T
	70	08/91 → 07/98	D	4D56T

**81787 350981787000**

**HYUNDAI**
**Grace**

2.5 TD	59	06/98 → 10/01	D	D4BF
--------	----	---------------	---	------

**H 100**

2.5 D	55	07/93 → 12/94	D	D4BA, D4BX
	57	12/94 → 03/00	D	D4BA
2.5 TD	59	07/93 → 03/00	D	D4BF
2.5 TDiC	59	06/98 → 10/03	D	D4BF

**Starex**

2.5 D	57	10/97 → 04/04	D	D4BF
2.5 TD	59	06/97 → 04/04	D	D4BF
2.5 TD 4WD	59	02/98 → 04/04	D	D4BF

**MITSUBISHI**
**L 200 II**

2.5 D	51	11/86 → 10/96	D	4D56 (8V) → 06-1996
2.5 D 4WD	51	12/87 → 05/93	D	4D56 (8V)

**L 200 III**

2.5 D	55	06/96 → 12/07	D	4D56 (8V)
-------	----	---------------	---	-----------

**L 300**

2.5 D	51	11/86 → 02/06	D	4D56 (8V)
2.5 TD	64	02/87 → 08/97	D	4D56T
	64	02/87 → 05/03	D	4D56T

**L 400**

2.5 TD	73	05/95 → 05/00	D	4D56TD
2.5 TD 4WD	73	05/95 → 05/00	D	4D56TD
2500 TD	64	05/95 → 06/05	D	4D56T
	64	09/96 → 06/05	D	4D56T
2500 TD 4WD	64	09/96 → 06/05	D	4D56T

**Pajero I**

2.5 TD	64	01/90 → 12/91	D	4D56T
	70	11/89 → 11/90	D	4D56T

**81789 350981789000**

**FLANGIA**

Numero Fori Flangia	4
Dimensione Fori Flangia	M6×1
Posizione Attacco	79
Diametro Mozzo	Ø24
Diametro Girante	Ø60
N° Alette Girante	7
Posizione Girante	9.5

**SUZUKI**
**Jimny**

1.3 16V	59	09/98 →	B	G13BB
1.3 16V 4WD	59	09/98 →	B	G13BB
1.3 4x4	63	09/98 → 08/00	B	G13BB

**Samurai**

1.3	47	11/88 → 12/04	B	G13A
1.3 Trazione integrale	51	11/88 → 12/04	B	G13BA
	44	11/88 → 12/04	B	G13A

**SJ 413**

1.3	44	08/86 → 08/90	B	G13A
	47	09/84 → 08/90	B	G13A

**81790 350981790000**

**FLANGIA**

Numero Fori Flangia	4
Dimensione Fori Flangia	M6×1
Posizione Attacco	79.8
Diametro Mozzo	Ø24
Diametro Girante	Ø58.5
N° Alette Girante	7
Posizione Girante	9

**SUZUKI**
**Baleno, Station Wagon**

1.6 i 16V	72	07/95 → 05/02	B	G16B
	73	08/96 → 05/02	B	G16B
1.6 i 16V 4x4	72	07/95 → 05/02	B	G16B
1.8 GTX	89	03/96 → 05/02	B	J18A
1.8 i 16V	89	08/96 → 05/02	B	J18A

**Swift II, Cabrio**

1.6	70	11/89 → 12/91	B	G16B
1.6 4WD	70	11/89 → 12/91	B	G16B
1.6 i	68	01/90 → 05/01	B	G16B
1.6 i 4WD	68	01/90 → 05/01	B	G16B

**81790**
**350981790000**

**SUZUKI**
**Vitara**

1.6	59	07/88 → 01/95	B	G16A (8V)
1.6 i 16V	71	07/90 → 03/99	B	G16B
1.6 i 16V Trazione integrale	71	07/90 → 03/98	B	G16B
1.6 Trazione integrale	59	07/88 → 03/98	B	G16A (8V)
	60	07/88 → 12/91	B	G16A (8V)
2.0 V6 24V Trazione integrale	100	12/94 → 03/98	B	H20A

**X-90**

1.6 i 16V	71	09/95 → 12/97	B	G16B
1.6 i 16V 4x4	71	09/95 → 12/97	B	G16B

**81791**
**350981791000**

**PULEGGIA**

Diametro Puleggia	Ø56.21
Numero Denti/Gole Puleggia	19
Altezza Puleggia	33.5
Posizione Attacco	52.2
Diametro Girante	Ø59.8
N° Alette Girante	8
Posizione Girante	48.2

**AUDI**
**A2**

1.2 TDI	45	03/01 → 08/05	D	ANY
1.4 TDI	55	02/00 → 08/05	D	AMF, BHC
	66	11/03 → 08/05	D	ATL

**A3 II, Sportback, Cabriolet**

1.9 TDI	77	05/03 → 05/10	D	BKC, BLS, BXE
	77	04/08 → 10/09	D	BLS

**FORD**
**Galaxy I**

1.9 TDI	96	02/03 → 05/06	D	ASZ
	110	05/05 → 05/06	D	BTB

**SEAT**
**Alhambra I**

1.9 TDI	96	11/02 → 11/08	D	ASZ
1.9 Tdi 4x4	96	06/05 → 11/08	D	ASZ

**81791**
**350981791000**

**SEAT**
**Altea, Altea XL**

1.9 TDI	66	08/09 →	D	BXF
	77	04/04 →	D	BJB, BKC, BLS, BXE
	77	10/06 →	D	BKC, BLS, BXE

**Arosa**

1.4 TDI	55	01/00 → 06/04	D	AMF
---------	----	---------------	---	-----

**Cordoba III, Vario**

1.4 TDI	51	05/05 → 11/09	D	BNM
	55	10/02 → 12/05	D	AMF
	59	06/05 → 11/09	D	BMS, BNV

1.9 TDI	74	09/02 → 11/09	D	ATD, AXR, BMT
	96	10/02 → 11/09	D	ASZ, BLT

**Ibiza IV**

1.4 TDI	51	05/05 → 11/09	D	BNM
	55	05/02 → 12/05	D	AMF
	59	06/05 → 11/09	D	BMS, BNV

1.9 TDI	74	02/02 → 11/09	D	ATD, AXR, BMT
	96	02/02 → 11/09	D	ASZ, BLT

**Ibiza V**

1.4 TDI	59	07/08 → 06/10	D	BMS
1.9 TDI	66	07/08 → 06/10	D	BXJ
	77	03/08 → 06/10	D	BLS

**Leon II**

1.9 TDI	66	06/07 → 12/10	D	BXF
	77	07/05 → 12/10	D	BKC, BLS, BXE
	81	10/05 → 12/12	D	ASV

**Toledo III**

1.9 TDI	77	10/04 → 05/09	D	BJB, BKC, BLS, BXE
---------	----	---------------	---	--------------------

**SKODA**
**Fabia I, Station Wagon, Van**

1.4 TDI	51	10/05 → 03/08	D	BNM
	55	04/03 → 03/08	D	AMF
	59	10/05 → 03/08	D	BNV
1.9 TDI	74	01/00 → 03/08	D	ATD, AXR
1.9 TDI RS	96	06/03 → 03/08	D	ASZ, BLT

**Fabia II, Station Wagon, Van**

1.4 TDI	51	02/07 → 03/10	D	BNM
	59	01/07 → 03/10	D	BMS, BNV
1.9 TDI	77	04/07 → 03/10	D	BLS, BSW

**81791 350981791000**

**SKODA**
**Octavia II, Station Wagon**

1.9 TDI	77	06/04 → 12/10	D	BJB, BKC, BLS, BXE
1.9 TDI 4x4	77	11/04 → 12/10	D	BKC, BLS, BXE

**Roomster, Van**

1.4 TDI	51	07/06 → 03/10	D	BNM
	59	09/06 → 03/10	D	BMS, BNV
1.9 TDI	77	09/06 → 03/10	D	BLS, BSW

**Superb II, Station Wagon**

1.9 TDI	77	03/08 → 11/10	D	BLS, BXE
---------	----	---------------	---	----------

**VOLKSWAGEN**
**Caddy III**

1.9 TDI	55	09/05 → 08/10	D	BSU
	77	04/04 → 08/10	D	BJB, BLS
1.9 TDI 4motion	77	11/08 → 08/10	D	BLS
2.0 SDI	51	03/04 → 08/10	D	BDJ, BST

**Crafter 30-35, 30-50**

2.5 TDI	65	04/06 → 07/11	D	BJJ, CEBA
---------	----	---------------	---	-----------

**Fox I**

1.4 TDI	51	04/05 →	D	BNM
---------	----	---------	---	-----

**Golf V, Plus, Variant**

1.9 TDI	66	05/05 → 12/08	D	BRU, BXF, BXJ
	77	01/05 → 01/09	D	BKC, BLS, BXE
	77	06/07 → 07/09	D	BLS, BXE
1.9 TDI 4motion	77	08/04 → 11/08	D	BKC, BLS, BXE
1.9 TDI 4motion	77	01/08 → 07/09	D	BLS
2.0 SDI	55	01/04 → 11/08	D	BDK

**Jetta III**

1.9 TDI	77	08/05 → 10/10	D	BKC, BLS, BXE
---------	----	---------------	---	---------------

**Lupo I**

1.2 TDI 3L	45	07/99 → 07/05	D	ANY, AYZ
1.4 TDI	55	01/99 → 07/05	D	AMF

**Multivan V**

1.9 TDI	62	01/06 → 11/09	D	BRR
	63	04/03 → 11/09	D	AXC
	75	06/06 → 11/09	D	BRS
	77	04/03 → 11/09	D	AXB

**81791 350981791000**

**VOLKSWAGEN**
**New Beetle, Cabrio**

1.9 TDI	74	02/01 → 09/10	D	ATD, BEW
1.9 TDI	77	07/05 → 09/10	D	BSW

**Passat VI, Variant, CC**

1.9 TDI	77	03/05 → 11/08	D	BKC, BLS, BXE
---------	----	---------------	---	---------------

**Polo IV (6N2)**

1.4 TDI	55	10/99 → 09/01	D	AMF
	66	01/00 → 10/00	D	ATL

**Polo V (9N)**

1.4 TDI	51	04/05 → 11/09	D	BNM, BWB
	55	10/01 → 06/05	D	AMF, BAY
	55	07/03 →	D	BAY
	59	04/05 → 11/09	D	BMS, BNV
	74	09/02 →	D	ATD
	74	10/01 → 11/09	D	ATD, AXR, BMT
	96	11/03 → 11/09	D	ASZ, BLT

**Sharan I**

1.9 TDI	96	11/02 → 03/10	D	ASZ
	110	06/05 → 03/10	D	BTB

**Touran I**

1.9 TDI	66	11/04 → 05/10	D	BRU, BXF, BXJ
	74	02/03 → 05/04	D	AVQ
	77	08/03 → 05/10	D	BKC, BLS, BXE

**Transporter V**

1.9 TDI	62	01/06 → 11/09	D	BRR
	63	04/03 → 11/09	D	AXC
	75	06/06 → 11/09	D	BRS
	77	04/03 → 11/09	D	AXB

81793

350981793000



**PULEGGIA**  
 Diametro Puleggia Ø94.8  
 Numero Denti/Gole Puleggia 5  
 Altezza Puleggia 25  
 Posizione Attacco 74.2  
 Diametro Girante Ø53.5  
 N° Alette Girante 7  
 Posizione Girante 10.5



**BMW**

**3 IV (E46), Touring, Cabrio, Coupé, Compact**

318 d	85	09/01 → 03/03	D	M47D20, M47D20 (204D1)	
320 d	95	02/98 → 04/05	D	M47D20 (204D1)	
	100	04/98 → 09/01	D	M47204D1, M47D20 (204D1)	M: M47204D1
	100	03/00 → 09/01	D	M47204D1, M47D20 (204D1)	

81794

350981794000



**PULEGGIA**  
 Diametro Puleggia Ø94.8  
 Numero Denti/Gole Puleggia 5  
 Altezza Puleggia 25  
 Posizione Attacco 74.25  
 Diametro Girante Ø61.5  
 N° Alette Girante 7  
 Posizione Girante 10.75



**BMW**

**3 IV (E46), Touring, Cabrio, Coupé, Compact**

320 d	100	04/98 → 09/01	D	M47204D1, M47D20 (204D1)	M: M47D20
	100	03/00 → 09/01	D	M47204D1, M47D20 (204D1)	

**5 IV (E39), Touring**

520 d	100	02/00 → 06/03	D	M47204D1, M47D20 (204D1)	
-------	-----	---------------	---	--------------------------------	--

81795

350981795000



**PULEGGIA**  
 Diametro Puleggia Ø95.5  
 Numero Denti/Gole Puleggia 5  
 Altezza Puleggia 25  
 Posizione Attacco 88.5  
 Diametro Girante Ø64.5  
 N° Alette Girante 6  
 Posizione Girante -0.7



**BMW**

**3 IV (E46), Touring, Cabrio, Coupé, Compact**

330 d	135	10/99 → 02/05	D	M57D30 (306D1)	
330 xd	135	06/00 → 02/05	D	M57D30 (306D1)	

**5 IV (E39), Touring**

525 d	120	02/00 → 06/03	D	M57D25 (256D1)	
530 d	135	08/98 → 09/00	D	M57D30 (306D1)	09-1999 →, → 09-2000
	142	09/00 → 06/03	D	M57D30 (306D1)	
	142	09/00 → 05/04	D	M57D30, M57D30 (306D1)	

**7 III (E38)**

730 d	135	08/98 → 04/00	D	M57D30 (306D1)	10-1999 →
	142	04/00 → 11/01	D	M57D30 (306D1)	

**X5 I (E53)**

3.0 d	135	05/01 → 12/03	D	M57D30 (306D1)	
-------	-----	---------------	---	-------------------	--

**LAND ROVER**

**Range Rover III**

3.0 D 4x4	130	03/02 → 08/12	D	306D1	
-----------	-----	---------------	---	-------	--

**OPEL**

**Omega B, Station Wagon**

2.5 DTI	110	09/01 → 07/03	D	Y25DT	
---------	-----	---------------	---	-------	--



**81796**
**350981796000**

**PULEGGIA**

Diametro Puleggia	Ø95.52
Numero Denti/Gole Puleggia	5
Altezza Puleggia	25
Posizione Attacco	88.5
Diametro Girante	Ø64.5
N° Alette Girante	6
Posizione Girante	-0.7

**KW**

**BMW**
**5 IV (E39), Touring**

530 d	135	08/98 → 09/00	D	M57D30 (306D1)	08-1998 →, → 08-1999
540 i	210	01/97 → 05/04	B	M62448S2, M62B44 (448S1), M62B44 (448S2), M62B44TU	09-1998 →, → 05-2004

**7 III (E38)**

730 d	135	08/98 → 04/00	D	M57D30 (306D1)	→ 09-1999
-------	-----	---------------	---	-------------------	-----------

**LANCIA**
**Lybra, Station Wagon**

2.4 JTD	110	05/02 → 10/05	D	841C.000	
---------	-----	---------------	---	----------	--

**81797**
**350981797000**

**PULEGGIA**

Diametro Puleggia	Ø53.1
Numero Denti/Gole Puleggia	18
Altezza Puleggia	25
Posizione Attacco	37
Diametro Girante	Ø52.8
N° Alette Girante	6

**KW**

**CITROËN**
**Berlingo I, Van**

1.1 i	44	07/96 →	B	HDZ (TU1M), HFX (TU1JP)	M →: 3.762.434
1.4	48	11/02 →	G	KFW (TU3JP)	
	53	11/02 → 10/05	B	KFW (TU3JP)	
1.4 bivalent	48	11/02 →		KFW (TU3JP)	
1.4 GNC	48	11/02 →	G	KFW (TU3JP)	
1.4 Hybrid	54	05/05 →		KFW (TU3JP)	

**81797**
**350981797000**

**KW**

**CITROËN**
**Berlingo I, Van**

1.4 i	55	07/96 →	B	KFW (TU3JP), KFX (TU3JP)	M →: 3.666.766
1.4 i bivalent	55	04/03 →	BF	KFW (TU3JP)	

**C 2, Van**

1.1	44	09/03 →	B	HFX (TU1JP)	
1.4	54	09/03 →	B	KFV (TU3JP)	
	55	10/06 →	B	KFV (TU3JP)	

**C 3 I, Pluriel**

1.1 i	44	02/02 →	B	HFX (TU1A), HFX (TU1JP)	
1.4	54	05/03 →	B	KFV (TU3JP)	
1.4 Hybrid	54	05/05 →		KFV (TU3JP)	
1.4 i	54	02/02 →	B	KFV (TU3A), KFV (TU3JP)	
1.4 i Bivalent	54	02/02 →		KFV (TU3JP)	

**C 3 II, Picasso**

1.1	44	11/09 →	B	HFX (TU1JP)	
1.1 BiFuel	44	11/10 →	BF	HFX (TU1A)	
1.4	54	11/09 →	B	KFT (TU3A), KFV (TU3A)	

**Nemo, Van**

1.4	54	04/09 →	B	KFT (TU3A), KFV (TU3A)	
	54	02/08 →	B	KFV (TU3A)	

**Saxo**

1.1 X,SX	40	05/96 → 09/03	B	HDZ (TU1M)	08-2000 →, M →: 3.666.766
	44	05/96 → 09/03	B	HDZ (TU1M), HFX (TU1JP)	08-2000 →, M →: 3.666.766
1.4 VTS	55	05/96 → 06/03	B	KFW (TU3JP), KFX (TU3JP)	08-2000 →, M →: 3.666.766

**Xsara, Break, Coupé, Picasso, Van**

1.4 i	55	04/97 → 03/05	B	KFW (TU3JP), KFX (TU3JP)	09-2000 →, M →: 3.666.766
	55	10/97 → 08/05	B	KFW (TU3JP), KFX (TU3JP)	M →: 3.666.766

**FIAT**
**Fiorino IV**

1.4	54	11/07 →	B	KFT, KFV	
-----	----	---------	---	----------	--

**Qubo**

1.4	54	02/08 →	B	KFT, KFV	
-----	----	---------	---	----------	--

**81797 350981797000**



**PEUGEOT**

**106 I, Van**

1.0	33	09/91 → 03/01	B	CDY (TU9M), TU9	
-----	----	---------------	---	--------------------	--

**205 II, Van**

1.1	40	08/98 → 07/00	B	HFY (TU1JP)	M →: 3.762.434
-----	----	---------------	---	-------------	----------------

1.1 i	44	09/98 →	B	HFX (TU1JP), HFZ (TU1JP)	M →: 3.762.434
-------	----	---------	---	-----------------------------	----------------

1.4 i	55	09/98 →	B	KFW (TU3JP), KFX (TU3JP)	M →: 3.666.766
-------	----	---------	---	-----------------------------	----------------

1.4 LPG	55	05/06 → 09/07		KFV (TU3JP)	
---------	----	---------------	--	-------------	--

**206 +**

1.1	44	01/09 →	B	HFX (TU1A), HFX (TU1JP), TU1AE5	
-----	----	---------	---	---------------------------------------	--

	54	09/10 →	B	KFT (TU3A)	
--	----	---------	---	------------	--

1.4 i	55	01/09 →	B	KFV (TU3A), KFW (TU3A)	
-------	----	---------	---	---------------------------	--

**206, CC, Van**

1.1	44	07/02 →	B	HFX (TU1JP)	M →: 3.762.434
-----	----	---------	---	-------------	----------------

	55	07/02 →	B	KFV (TU3A), KFW (TU3JP)	M →: 3.666.766
--	----	---------	---	----------------------------	----------------

1.4	55	03/07 →	B	KFV (TU3A), KFW (TU3JP)	
-----	----	---------	---	----------------------------	--

**207, Station Wagon, CC, Van**

	53	02/06 →	B	KFV (TU3A)	
--	----	---------	---	------------	--

	54	12/07 →	B	KFT (TU3A), KFV (TU3A)	
--	----	---------	---	---------------------------	--

1.4	54	12/07 →	B	KFV (TU3A)	
-----	----	---------	---	------------	--

	55	08/08 →	B	KFV (TU3A), KFW (TU3A)	
--	----	---------	---	---------------------------	--

1.4 Bioflex	60	08/08 →		KFW (TU3JP)	
-------------	----	---------	--	-------------	--

1.4 Flex	60	11/08 →		KFW (TU3A)	
----------	----	---------	--	------------	--

**306, Station Wagon, Coupé, Cabrio, Van**

1.4	55	05/93 → 05/01	B	KDX (TU3MC), KFW (TU3JP), KFX (TU3JP)	M →: 3.666.766
-----	----	---------------	---	---	----------------

	55	03/97 → 04/02	B	KFW (TU3JP), KFX (TU3JP)	M →: 3.666.766
--	----	---------------	---	-----------------------------	----------------

1.4 SL	55	06/94 → 05/01	B	KDX (TU3MC), KFW (TU3JP), KFX (TU3JP)	M →: 3.666.766
--------	----	---------------	---	---	----------------

**307, Station Wagon, CC**

1.4	55	08/00 →	B	KFW (TU3JP)	M →: 3.666.766
-----	----	---------	---	-------------	----------------

**81797 350981797000**



**PEUGEOT**

**1007**

1.4	54	04/05 →	B	KFV (TU3JP)	
-----	----	---------	---	-------------	--

1.4 16V	65	10/05 →	B	KFU (ET3J4)	
---------	----	---------	---	-------------	--

**Bipper, Tepee**

1.4	54	02/08 →	B	KFV (TU3A)	
-----	----	---------	---	------------	--

**Partner I**

	44	06/96 →	B	HDZ (TU1M)	11-2002 →
--	----	---------	---	------------	-----------

1.1	44	06/96 →	B	HDZ (TU1M), HFX (TU1JP)	11-2002 →
-----	----	---------	---	----------------------------	-----------

	54	11/02 → 10/06	B	KFW (TU3JP)	
--	----	---------------	---	-------------	--

1.4	55	06/96 →	B	KFW (TU3JP), KFX (TU3JP), TU32	11-2002 →
-----	----	---------	---	--------------------------------------	-----------

	55	06/96 →	B	KFX (TU3JP), TU32	11-2002 →
--	----	---------	---	----------------------	-----------

1.4 BiFuel	55	04/03 →	BF	KFW (TU3JP)	M →: 3.666.766
------------	----	---------	----	-------------	----------------

**81798 350981798000**



**PULEGGIA**

Diametro Puleggia	Ø62
Numero Denti/Gole Puleggia	21
Altezza Puleggia	30
Posizione Attacco	39.1
Diametro Girante	Ø72
N° Alette Girante	20
Posizione Girante	29



**CITROËN**

**C 1 I**

1.4 HDi	40	06/05 →	D	8HT (DV4TD)	
---------	----	---------	---	-------------	--

**C 2, Van**

	50	04/09 →	D	8HX (DV4TD)	
--	----	---------	---	-------------	--

1.4 HDi	50	09/03 →	D	8HX (DV4TD), 8HZ (DV4TD)	
---------	----	---------	---	-----------------------------	--

**C 3 I, Pluriel**

1.4 16V HDi	66	02/02 →	D	8HY (DV4TED4)	
-------------	----	---------	---	------------------	--

1.4 HDi	50	02/02 →	D	8HX (DV4TD)	
---------	----	---------	---	-------------	--

	55	05/05 →	D	8HX (DV4TD)	
--	----	---------	---	-------------	--

**C 3 II, Picasso**

1.4 HDi 70	50	11/09 →	D	8HR (DV4C), 8HZ (DV4TD)	
------------	----	---------	---	----------------------------	--

**DS 3, Cabrio**

1.4 HDi 70	50	04/10 → 07/15	D	8HR (DV4C)	
------------	----	---------------	---	------------	--

**81798 350981798000**

**KW**

**CITROËN**
**Nemo, Van**

1.4 HDi	50	02/08 →	D	8HS (DV4TED)
	50	04/09 →	D	8HS (DV4TED)

**Xsara, Break, Coupé, Picasso, Van**

1.4 HDi	50	01/03 → 03/05	D	8HX (DV4TD)
---------	----	---------------	---	-------------

**FORD**
**B-Max, Van**

1.5 TDCi	55	10/12 →	D	UGJC
1.6 TDCi	70	10/12 →	D	T3JB

**C-Max I**

1.6 TDCi	74	02/07 → 09/10	D	G8DC, MTD A
----------	----	---------------	---	-------------

**Ecosport II**

1.5 TDCi	66	10/13 →	D	UGJE
----------	----	---------	---	------

**Fiesta V, Van**

1.4 TDCi	50	11/01 → 06/08	D	F6JA, F6JB
----------	----	---------------	---	------------

**Fiesta VI, Van**

1.4 TDCi	50	01/09 →	D	F6JB
	51	07/10 →	D	F6JD, KVJA
1.5 TDCi	55	09/12 →	D	UGJC
1.6 TDCi	66	01/09 →	D	HHJC, HHJD, HHJE
	70	02/10 →	D	T3JA, TZJA, TZJB

**Focus II, Station Wagon, Cabrio**

1.6 TDCi	74	07/04 → 09/12	D	G8DC, MTD A
	81	12/07 → 09/12	D	G8DA

**Focus III, Station Wagon, Van**

1.6 TDCi ECOnetic	77	05/12 →	D	NGDA, NGDB
-------------------	----	---------	---	------------

**Fusion**

1.4 TDCi	50	08/02 → 07/05	D	F6JA, F6JB
----------	----	---------------	---	------------

**Galaxy II**

1.6 TDCi	85	02/11 → 06/15	D	T1WA, T1WB
----------	----	---------------	---	------------

**Grand C-Max**

1.6 TDCi	70	12/10 →	D	T3DA, T3DB
	85	12/10 →	D	T1DA, T1DB

**S-Max**

1.6 TDCi	85	02/11 →	D	T1WA, T1WB
----------	----	---------	---	------------

**Tourneo II Connect, Courier, Custom**

1.6 TDCi	55	09/13 →	D	UBGA
	70	09/13 →	D	TZGA, TZGB
	85	09/13 →	D	T1GA

**81798 350981798000**

**KW**

**FORD**
**Transit Connect II, Courier**

1.6 TDCi	55	02/13 →	D	UBGA
	70	02/13 →	D	TZGA, TZGB
	85	02/13 →	D	T1GA

**MAZDA**
**2 I**

1.4 CD	50	04/03 →	D	F6JA, F6JB
--------	----	---------	---	------------

**2 II, Saloon**

1.4 MZR-CD	50	01/08 → 06/15	D	Y404
------------	----	---------------	---	------

**PEUGEOT**
**107**

1.4 HDi	40	06/05 →	D	8HT (DV4TD)
---------	----	---------	---	-------------

**205 II, Van**

1.4 HDi	51	09/02 → 02/07	D	8HX (DV4TD)
1.4 HDi eco 70	50	09/01 →	D	8HX (DV4TD), 8HZ (DV4TD)

**206 +**

1.4 HDi eco 70	50	01/09 →	D	8HX (DV4TD), 8HZ (DV4TD)
----------------	----	---------	---	--------------------------

**206, CC, Van**

1.4 HDi	50	07/02 →	D	8HX (DV4TD)
	50	09/01 → 03/09	D	8HX (DV4TD), 8HZ (DV4TD)
1.4 HDi eco 70	50	09/08 →	D	8HZ (DV4TD)

**207, Station Wagon, CC, Van**

1.4 HDi	50	02/06 →	D	8HR (DV4C), 8HZ (DV4TD)
	50	04/07 →	D	8HZ (DV4TD)

**208**

1.4 HDi	50	03/12 →	D	8HP (DV4C), 8HR (DV4C)
---------	----	---------	---	------------------------

**307, Station Wagon, CC**

1.4 HDi	50	10/01 →	D	8HX (DV4TD), 8HZ (DV4TD)
	50	03/02 →	D	8HZ (DV4TD)

**1007**

1.4 HDi	50	04/05 →	D	8HX (DV4TD), 8HZ (DV4TD)
---------	----	---------	---	--------------------------

**2008**

1.4 HDi	50	06/13 →	D	8HR (DV4C)
---------	----	---------	---	------------

**Bipper, Tepee**

1.4 HDi	50	02/08 →	D	8HS (DV4TED)
---------	----	---------	---	--------------

## 81798 350981798000



### SUZUKI

#### Liana

1.4 DDiS	66	04/04 →	D	8HY
----------	----	---------	---	-----

### TOYOTA

#### Aygo I

1.4 HDi	40	07/05 → 08/10	D	2WZ-TV
---------	----	---------------	---	--------

## 81799 350981799000



### PULEGGIA

Diametro Puleggia	Ø59.85
Numero Denti/Gole Puleggia	20
Altezza Puleggia	32.3
Posizione Attacco	62
Diametro Girante	Ø61.5
N° Alette Girante	8
Posizione Girante	22.2



### CITROËN

#### C 4 I, Coupé, Picasso, Grand Picasso

1.8 Bifuel	92	01/09 → 10/12	BF	6FY (EW7A)
1.8 i 16V	92	10/06 →	B	6FY (EW7A)
2.0 16V	100	11/04 → 07/07	B	RFN(EW10J4)
	103	11/04 → 07/11	B	RFJ(EW10A)
	130	11/04 → 12/10	B	RFK (EW10J4S)
2.0 i 16V	103	10/06 →	B	RFJ(EW10A)

#### C 5 I, Break

1.8 16V	85	03/01 → 08/04	B	6FZ (EW7J4)
2.0 16V	100	03/01 → 08/04	B	RFN (EW10J4)
2.0 16V HPi	103	03/01 → 08/04	B	RLZ(EW10D)

#### C 5 II, Break

1.8 16V	92	09/05 →	B	6FY (EW7A)
	85	09/04 →	B	6FZ (EW7J4)
2.0 16V	103	09/04 →	B	RFJ(EW10A)

#### C 5 III, Break

1.8 16V	92	02/08 →	B	6FY (EW7A)
2.0 16V	103	02/08 →	B	RFJ(EW10A)
2.0 16V BioFlex	103	02/08 →		RFJ(EW10A)

#### C 8

2.0	100	07/02 →	B	RFN (EW10J4)
2.0 16V	103	09/05 →	B	RFJ(EW10A)
	104	09/05 →	B	RFJ(EW10A)
2.2	116	07/02 →	B	3FZ(EW12J4)

## 81799 350981799000



### CITROËN

#### Evasion

2.0 16V	100	05/00 → 07/02	B	RFN (EW10J4)
---------	-----	---------------	---	--------------

#### Jumpy I

2.0	100	04/00 → 12/06	B	RFN(EW10J4)
-----	-----	---------------	---	-------------

2.0 i 16V	102	03/00 →	B	RFN(EW10J4)
-----------	-----	---------	---	-------------

#### Jumpy II

2.0	100	12/03 → 10/06	B	RFN(EW10J4)
-----	-----	---------------	---	-------------

#### Jumpy III

2.0 i	103	01/07 →	B	RFH (EW10A)
-------	-----	---------	---	-------------

#### Xsara, Break, Coupé, Picasso, Van

1.8 16V	85	02/00 →	B	6FZ (EW7J4)
---------	----	---------	---	-------------

1.8 VTS	85	09/00 → 10/04	B	6FZ (EW7J4)
---------	----	---------------	---	-------------

2.0 16V	100	09/00 → 03/05	B	RFN(EW10J4)
---------	-----	---------------	---	-------------

### FIAT

#### Scudo I

2.0	100	05/00 → 12/06	B	RFN(EW10J4)
-----	-----	---------------	---	-------------

2.0 16V	100	06/00 → 12/06	B	RFN(EW10J4)
---------	-----	---------------	---	-------------

#### Ulysse II

2.0	100	08/02 → 06/11	B	RFN(EW10J4)
-----	-----	---------------	---	-------------

### LANCIA

#### Phedra

2.0	100	09/02 → 11/10	B	RFN(EW10J4)
-----	-----	---------------	---	-------------

#### Zeta

2.0 16V	100	07/00 → 09/02	B	RFN
---------	-----	---------------	---	-----

### PEUGEOT

#### 205 II, Van

2.0 RC	130	07/03 →	B	RFK (EW10J4S)
--------	-----	---------	---	---------------

2.0 S16	99	04/99 → 10/00	B	RFR (DEW10J4)
	100	06/99 →	B	RFN(EW10J4)

#### 206, CC, Van

2.0 16V	100	07/02 →	B	RFN(EW10J4)
---------	-----	---------	---	-------------

2.0 S16	100	09/00 →	B	RFN(EW10J4)
---------	-----	---------	---	-------------

#### 307, Station Wagon, CC

2.0	100	03/02 →	B	RFN(EW10J4)
	105	08/08 →	B	RFN (EW10J4)

2.0 16V	100	08/00 →	B	RFN (EW10J4)
	103	03/05 →	B	RFJ (EW10A) M: EW10J4
	103	03/05 →	B	RFJ (EW10A)

2.0 16V	103	03/05 →	B	RFJ (EW10A), RFN(EW10J4)
	130	06/05 →	B	RFK (EW10J4S)

**81799** **350981799000**

**PEUGEOT**
**407, Station Wagon, Coupé**

1.8	85	05/04 →	B	6FZ (EW7J4)	
1.8 16V	92	09/05 →	B	6FY (EW7A)	
2.0	100	05/04 →	B	RFN (EW10J4)	
2.0 16V	99	01/99 → 08/00	B	RFR (DEW10J4)	
	100	08/00 → 06/04	B	RFN (EW10J4)	
2.0 16V	100	10/00 → 12/04	B	RFN (EW10J4), RFV (XU10J4R)	
	103	09/05 →	B	RFJ (EW10A)	
2.0 16V	97	11/95 → 05/04	B	RFV (XU10J4R)	04-1999 →
2.0 16V HPI	103	05/01 → 05/04	B	RLZ (EW10D)	
2.0 Bioflex	103	09/07 →		RFJ (EW10A)	
2.2	116	07/00 → 05/04	B	3FZ (EW12J4)	
2.2 16V	120	09/05 →	B	3FY (EW12J4)	

**607**

2.0	100	02/00 →	B	RFN (EW10J4)	
2.2 16V	116	02/00 →	B	3FZ (EW12J4)	
	120	09/05 →	B	3FY (EW12J4)	

**806**

2.0 16V	100	09/00 → 08/02	B	RFN (EW10J4)	
---------	-----	---------------	---	--------------	--

**807**

2.0	100	06/02 →	B	RFN (EW10J4)	
2.0 16V	103	09/05 →	B	RFJ (EW10A)	
2.2	116	06/02 →	B	3FZ (EW12J4)	

**Expert I**

2.0	100	07/00 →	B	RFN (EW10J4)	
-----	-----	---------	---	--------------	--

**Expert II, Tepee**

2.0 16V	103	01/07 →	B	RFH (EW10A), RFJ (EW10A)	
---------	-----	---------	---	-----------------------------	--

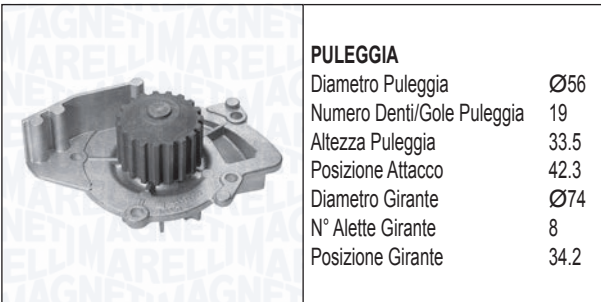
**81800** **350981800000**

**CITROËN**
**C 4 I, Coupé, Picasso, Grand Picasso**

2.0 HDi	100	11/04 → 12/10	D	RHR (DW10BTED4)	
	103	07/08 → 07/11	D	RHF (DW10BTED4)	
2.0 HDi 138	100	10/06 →	D	RHJ (DW10BTED4), RHR (DW10BTED4)	

**C 5 I, Break**

2.2 HDi	98	03/01 → 08/04	D	4HX (DW12TED4/ FAP)	
---------	----	---------------	---	------------------------	--

**C 5 II, Break**

2.0 HDi	100	09/04 →	D	RHR (DW10BTED4)	
2.2 HDi	98	09/04 →	D	4HX (DW12TED4/ FAP)	

**C 5 III, Break**

2.0 HDi	100	02/08 →	D	RHF (DW10BTED4), RHR (DW10BTED4)	
	100	02/08 →	D	RHR (DW10BTED4)	
2.0 HDi 140	103	04/09 →	D	RHF (DW10BTED4)	
2.0 HDi 165	120	04/09 →	D	RHH (DW10CTED4)	

**C 8**

2.0 HDi	80	07/02 →	D	RHW (DW10ATED4)	
	88	02/07 →	D	RHK (DW10UTED4)	

**81800**
**35098180000**

**KW**

**CITROËN**
**C 8**

2.0 HDi 135	100	03/06 →	D	RHD (DW10CB), RHD (DW10CTED4), RHR (DW10BTED4)
2.0 HDi 165	120	03/06 →	D	RHE (DW10CTED4), RHH (DW10CTED4)
2.2 HDi	94	07/02 →	D	4HW (DW12TED4)

**Jumper II**

2.2 HDi	74	04/02 →	D	4HY (DW12UTED)
---------	----	---------	---	-------------------

**Jumpy III**

2.0 HDi 120	88	01/07 →	D	RHK (DW10UTED4)
2.0 HDi 140	100	01/07 →	D	RHR (DW10BTED4)

**FIAT**
**Scudo II**

2.0 D Multijet	88	01/07 →	D	RHK
	100	01/07 →	D	DW10BTED4, RHR
	100	01/07 →	D	RHR
2.0 D Multijet 4x4	88	01/07 →	D	RHK

**Ulysse II**

2.0 D Multijet	88	05/06 → 06/11	D	RHK
	100	05/06 → 06/11	D	RHR
2.2 JTD	94	08/02 → 08/06	D	4HW (DW12ATED4)

**FORD**
**C-Max I**

2.0 TDCi	81	02/08 → 09/10	D	IXDA
	98	02/07 → 09/10	D	G6DC, G6DE, G6DF
	100	02/07 → 09/10	D	G6DA, G6DB, G6DD, G6DG

**Focus C-Max**

2.0 TDCi	98	10/03 → 03/07	D	G6DC, G6DE, G6DF
	100	10/03 → 03/07	D	G6DA, G6DB, G6DD, G6DG

**81800**
**35098180000**

**KW**

**CITROËN**
**Focus II, Station Wagon, Cabrio**

2.0 TDCi	81	02/08 → 07/11	D	IXDA
	98	07/04 → 01/08	D	G6DE, G6DF
	100	07/04 → 09/12	D	G6DA, G6DB, G6DD

**Galaxy II**

2.0 TDCi	85	11/07 → 06/15	D	KLWA, TYWA
	96	05/06 → 06/15	D	AZWA
	100	05/06 → 06/15	D	AZWC, UKWA → 05-2009
	103	05/06 → 06/15	D	QXWA, QXWB, QXWC, UFWA

**Kuga I**

2.0 TDCi	100	03/08 → 11/12	D	G6DG, UKDA
2.0 TDCi 4x4	100	03/08 → 11/12	D	G6DG, UKDA

**Mondeo IV, Station Wagon**

2.0 TDCi	85	11/07 → 09/14	D	KLBA, LPBA, TYBA
	96	03/07 → 09/14	D	AZBA
	100	03/07 → 09/14	D	AZBC, UKBA, UKBB
	103	03/07 → 09/14	D	QXBA, QXBB, UFBA, UFBB

**S-Max**

2.0 TDCi	85	11/07 →	D	KLWA, TYWA
	96	05/06 →	D	AZWA
	100	05/06 →	D	AZWC, UKWA
	103	05/06 →	D	QXWA, QXWB, QXWC, UFWA

**LANCIA**
**Phedra**

2.0 D Multijet	100	07/06 → 11/10	D	RHR (DW10BTED4)
2.0 JTD	88	06/06 → 11/10	D	RHK (DW10UTED4)
2.2 JTD	94	09/02 → 11/10	D	4HW (DW12ATED4)

**PEUGEOT**
**307, Station Wagon, CC**

2.0 HDi 135	100	10/03 →	D	RHR (DW10BTED4)
-------------	-----	---------	---	--------------------

**81800 35098180000**

**PEUGEOT**
**308 I, Station Wagon, CC**

2.0 HDi	100	09/07 →	D	RHR (DW10BTED4)
	103	04/09 →	D	RHF (DW10BTED4)
	103	07/10 →	D	RHR (DW10BTED4)

**407, Station Wagon, Coupé**

2.0 HDi	100	10/05 →	D	RHR (DW10BTED4)
	103	08/08 →	D	RHF (DW10BTED4)
	103	08/08 →	D	RHR (DW10BTED4)
	110	02/10 →	D	RHE (DW10CTED4)
	120	07/09 →	D	RHH (DW10CTED4)
2.0 HDi 135	100	05/04 →	D	RHR (DW10BTED4)
2.2 HDi	98	03/00 → 05/04	D	4HX (DW12TED4/ FAP)

**508, Station Wagon**

2.0 HDi	100	11/10 →	D	RHR (DW10BTED4)
---------	-----	---------	---	--------------------

**607**

2.0 HDi	100	09/05 →	D	RHR (DW10BTED4)
2.2 HDi	98	02/00 →	D	4HX (DW12TED4/ FAP)

**807**

2.0 HDi	80	04/04 → 05/06	D	RHW (DW10ATED4)
	88	02/06 →	D	RHK (DW10UTED4)
	100	06/06 →	D	RHR (DW10BTED4)
2.2 HDi	94	06/02 →	D	4HW (DW12BTED4), 4HX (DW12TED4/ FAP)

**81800 35098180000**

**PEUGEOT**
**Boxer II**

2.2 HDi	74	04/02 →	D	4HY (DW12UTED)
---------	----	---------	---	-------------------

**Expert I**

2.0 HDi	69	07/00 →	D	RHX (DW10BTED)
	80	07/00 →	D	RHW (DW10ATED4)
	80	07/00 →	D	RHZ (DW10ATED), RHZ (DW10BTED), RHZ (DW10CTED)

**Expert II, Tepee**

2.0 HDi 120	88	01/07 →	D	RHK (DW10UTED4)
2.0 HDi 140	100	01/07 →	D	RHR (DW10BTED4)

**Partner I**

2.0 HDi 4x4	66	04/04 → 08/05	D	RHY (DW10TD)
-------------	----	---------------	---	-----------------

**VOLVO**
**C 30**

2.0 D	100	10/06 → 12/12	D	D4204T
-------	-----	---------------	---	--------

**C 70 II**

2.0 D	100	01/08 → 10/09	D	D4204T
-------	-----	---------------	---	--------

**S 40 II**

2.0 D	100	01/04 →	D	D4204T
2.0 D4	96	07/05 →	D	D4204T2

**S 80 II**

2.0 TDi	100	02/08 →	D	D4204T
---------	-----	---------	---	--------

**V 50**

2.0 D	100	04/04 →	D	D4204T
-------	-----	---------	---	--------

**V 70 III**

2.0 D	100	10/07 →	D	D4204T
-------	-----	---------	---	--------

**81801**
**350981801000**

**PULEGGIA**

Diametro Puleggia Ø59.27  
 Numero Denti/Gole Puleggia 20  
 Altezza Puleggia 16  
 Posizione Attacco 46.5  
 Diametro Girante Ø63  
 N° Alette Girante 8  
 Posizione Girante 34

**KW**

**AUTOBIANCHI**
**Y10**

1.0	33	03/85 → 10/95	B	156A2.000
1.0 4WD	37	12/86 → 10/95	B	156A3.000
1.0 Cat.	33	10/87 → 10/95	B	156A2.246
1.1	42	06/89 → 10/95	B	156C.000
1.1 4WD	42	06/89 → 10/95	B	156C.000
1.1 i.e. Cat.	42	09/90 → 10/95	B	156C.046

**FIAT**
**Punto I, Cabrio, Van**

55 1.1	40	09/93 → 09/99	B	176A6.000, 176B2.000
75 1.2	54	10/93 → 09/99	B	176A8.000

**Cinquecento**

1.1 Sporting	40	10/94 → 01/98	B	176B2.000
--------------	----	---------------	---	-----------

**Palio I, Weekend**

1.2	50	06/99 → 10/00	B	178E2.000	→ M: 9.042.882
	54	06/98 →	B	176A8.000, 178B5.000, 178E2.000	→ M: 9.042.882
	54	04/96 → 02/01	B	178B5.000	→ M: 9.042.882

**Panda I, Van**

1.1	37	05/91 → 03/95	B	156C.046
	32	01/86 → 04/92	B	156A2.100
	32	01/86 → 02/92	B	156A2.100, 156A3.100
1000	37	01/85 → 12/92	B	156A3.000
	33	05/86 → 12/94	B	141C2.000, 156A2.246
1000 4x4	37	01/86 → 12/92	B	156A3.000
1000 i.e.	33	08/92 → 02/04	B	156A2.246
1000 i.e. Cat.	33	10/87 → 08/98	B	141C2.000, 156A2.246
	37	05/91 → 12/99	B	156C.046
1100	40	02/95 → 09/03	B	176B2.000, 187A1.000
	40	02/95 → 07/04	B	176B2.000

**81801**
**350981801000**

**KW**

**FIAT**
**Panda I, Van**

1100 Trekking 4x4	37	10/91 → 07/04	B	156C.046
750	25	01/86 → 10/03	B	141B.000, 156A4.000, 156A4.048

**Punto I, Cabrio, Van**

1.1	40	04/96 → 02/00	B	176B2.000
	43	04/94 → 06/00	B	176A7.000
60 1.2	44	05/95 → 06/00	B	176B1.000, 176B4.000

**Seicento, Van**

1.1	40	01/98 → 01/10	B	176B2.000	→ 04-1999, → M: 9.042.882
	40	01/98 → 01/10	B	176B2.000, 187A1.000	→ 04-1999, → M: 9.042.882

**Siena I**

1.2	54	09/98 → 12/09	B	178B5.000	→ 06-1999
-----	----	---------------	---	-----------	-----------

**Strada**

1.2	54	06/99 →	B	178B5.000
-----	----	---------	---	-----------

**Tipo I**

1.1	41	01/88 → 10/91	B	160A3.000
-----	----	---------------	---	-----------

**Uno I**

1.0	31	06/89 → 02/92	B	156A2.000	
1.0 iE	34	05/98 → 08/00	B	156A2.246	
45 1.0	32	06/86 → 12/93	B	156A2.048, 156A2.100	
45 i.e. 1.0	33	04/84 → 10/95	B	156A2.246	
50 1.1	37	01/90 → 12/93	B	156C.046	01-1989 →, → 12-1991
50 i.e. 1.1	36	06/92 → 12/93	B	146C3.000	
60 1.1	42	04/89 → 12/92	B	160A3.000	

**LANCIA**
**Y10**

1.0 Fire	37	03/85 → 02/90	B	156A2.000
	32	06/85 → 06/91	B	156A2.100
	33	03/85 → 02/92	B	156A2.000, 156A2.246
1.0 Fire Trazione integrale	37	12/87 → 02/90	B	156A2.000
	33	12/87 → 02/92	B	156A2.000, 156A2.246
1.1 Fire	40	01/95 → 12/95	B	176B2.000
1.1 Fire Trazione integrale	40	01/95 → 12/95	B	176B2.000



**81801 350981801000**

**LANCIA**
**Y10**

1.1 i.e Fire	42	08/89 → 06/92	B	156C.000	
1.1 i.e Fire Trazione integrale	42	08/89 → 06/92	B	156C.000	
1.1 i.e. Fire	37	07/89 → 09/95	B	156C.046	
1.1 i.e. Fire Trazione integrale	37	09/92 → 12/95	B	156C.046	

**Y**

1.1	40	11/95 → 09/03	B	176B2.000	
1.2	44	03/96 → 09/03	B	188A4.000, 840A3.000	→ 08-2000

**81802 350981802000**



**FLANGIA**

Numero Fori Flangia 4

Dimensione Fori Flangia M8×1.25

Posizione Attacco 59.8

Diametro Centraggio Ø58

Diametro Girante Ø79

N° Alette Girante 6

Posizione Girante 28

**FORD**
**C-Max I**

1.8 TDCi	85	02/07 → 09/10	D	KKDA	
----------	----	---------------	---	------	--

**Fiesta IV, Van**

1.8 DI	55	09/00 → 08/03	D	RTN, RTP	
	55	04/00 → 01/02	D	RTN, RTP, RTQ	
TD 1.8	55	03/00 → 08/03	D	RTN, RTP, RTQ	

**Focus C-Max**

1.8 TDCi	85	01/05 → 03/07	D	KKDA	
----------	----	---------------	---	------	--

**Focus I, Station Wagon**

1.8 DI / TDDi	55	08/99 → 11/04	D	BHDA, BHDB	
1.8 TDCi	74	08/02 → 11/04	D	FFDA	
	85	03/01 → 11/04	D	F9DA, F9DB	
1.8 Turbo DI / TDDi	55	08/01 → 03/05	D	BHDA, BHDB	
	66	10/98 → 11/04	D	C9DA, C9DB, C9DC	

**Focus II, Station Wagon, Cabrio**

1.8 TDCi	85	01/05 → 09/12	D	KKDA, KKDB	
----------	----	---------------	---	------------	--

**81802 350981802000**

**FORD**
**Galaxy II**

1.8 TDCi	74	05/06 → 06/15	D	FFWA	
	92	05/06 → 06/15	D	QYWA	

**Mondeo IV, Station Wagon**

1.8 TDCi	74	03/07 → 09/14	D	FFBA	
	92	06/07 →	D	KHBA, QYBA	

**S-Max**

1.8 TDCi	74	01/07 →	D	FFWA	
	92	05/06 →	D	QYWA	

**Tourneo I Connect, Grand Tourneo Connect**

1.8 TDCi	66	06/02 → 12/13	D	HCPA, HCPB, P9PA, P9PB, P9PC, P9PD, R3PA, RWPE, RWPF	
	81	08/06 → 12/13	D	RWPA, RWPC, RWPD	
1.8 TDCi / TDDi / DI	55	06/02 → 12/13	D	BHPA, P7PA, P7PB, R2PA	

**Transit Connect I**

1.8 Di	55	06/02 → 12/13	D	BHPA, P7PA, P7PB, R2PA	
1.8 TDCi	66	06/02 → 12/13	D	HCPA, HCPB, P9PA, P9PB, P9PC, P9PD, R3PA, RWPE, RWPF	
	81	08/06 → 12/13	D	RWPA, RWPC, RWPD	

**81803 350981803000**



**FLANGIA**

Numero Fori Flangia 3

Dimensione Fori Flangia M8×1.25

Posizione Attacco 40.25

Diametro Mozzo Ø23.4

Diametro Girante Ø70

N° Alette Girante 6

Posizione Girante 40.4

**FORD**
**Cougar**

2.0 16V	96	08/98 → 12/01	B	EDBA, EDBB, EDBC, EDBD	
---------	----	---------------	---	---------------------------	--

**Escort Classic**

1.6 16V	66	10/98 → 07/00	B	L1E	
---------	----	---------------	---	-----	--

## 81803 350981803000



### FORD

#### Focus I, Station Wagon

1.8 16V	85	10/98 → 11/04	B	EYDB, EYDC, EYDD, EYDE, EYDF, EYDG, EYDI, EYDJ, EYDL
1.8 BiFuel	82	02/03 → 01/05	BF	
2.0 16V	96	10/98 → 11/04	B	EDDB, EDDC, EDDD, EDDF
RS	158	10/02 → 11/04	B	HMDA
ST170	127	03/02 → 11/04	B	ALDA

#### Tourneo I Connect, Grand Tourneo Connect

1.8 16V	85	06/02 → 12/13	B	EYPA, EYPC, EYPD
---------	----	---------------	---	------------------

#### Transit Connect I

1.8 16V	85	06/02 → 12/13	B	EYPA, EYPC, EYPD
1.8 16V LPG	85	06/02 → 12/13		EYPC

### MAZDA

#### Tribute

2.0	91	03/00 → 05/08	B	YF
2.0 4WD	91	03/00 → 05/08	B	YF

## 81804 350981804000



### FLANGIA

Numero Fori Flangia	3
Dimensione Fori Flangia	M8x1.25
Posizione Attacco	50.5
Diametro Girante	Ø67
N° Alette Girante	6
Posizione Girante	43.4



### FORD

#### C-Max I

1.8	90	02/07 → 09/10	B	QQDC
	92	02/07 → 09/10	B	QQDA, QQDB
1.8 Flexifuel	92	02/07 → 09/10		Q7DA
2.0	107	02/07 → 09/10	B	AODA, AODB, AODE, SYDA
2.0 CNG	107	04/09 → 09/10		SYDA
2.0 LPG	107	06/08 → 09/10		SYDA

#### Fiesta V, Van

ST150	110	03/05 → 06/08	B	N4JB
-------	-----	---------------	---	------

## 81804 350981804000



### FORD

#### Focus C-Max

1.8	88	10/03 → 03/07	B	CSDA, CSDB
	92	04/04 → 03/07	B	Q7DA, QQDA, QQDB
1.8 Flexifuel	92	01/06 → 03/07		Q7DA
2.0	107	03/04 → 03/07	B	AODA, AODB, SYDA

#### Focus II, Station Wagon, Cabrio

1.8	92	03/06 → 09/12	B	Q7DA, QQDB
	92	03/06 → 09/12	B	QQDB
1.8 Flexifuel	92	01/06 → 09/12		Q7DA
	96	12/05 → 01/08		QQDD
	96	12/05 → 01/08		
2.0	107	10/06 → 07/11	B	AODA, AODB
	107	07/04 → 09/12	B	AODA, AODB, AODE
2.0 CNG	107	04/09 → 07/11		SYDA
2.0 LPG	107	06/08 → 07/11		SYDA

#### Focus III, Station Wagon, Van

2.0 ST	184	07/12 →	B	R9DA
--------	-----	---------	---	------

#### Galaxy II

2.0	107	05/06 → 06/15	B	AOWA, AOWB
2.0 EcoBoost	149	03/10 → 06/15	B	TNWA
2.0 Flexifuel	107	05/06 → 06/15		TBWA, TBWB
2.3	118	09/07 → 06/15	B	SEWA

#### Galaxy III

2.0 EcoBoost	176	01/15 →	B	R9CD, R9CI
--------------	-----	---------	---	------------

#### Maverick II

2.3 16V	110	03/04 →	B	GZ
---------	-----	---------	---	----

#### Mondeo III, Station Wagon

1.8 16V	81	10/00 → 03/07	B	CGBA, CGBB
	92	10/00 → 03/07	B	CHBA, CHBB
1.8 SCi	96	06/03 → 03/07	B	CFBA
2.0 16V	107	10/00 → 03/07	B	CJBA, CJBB

#### Mondeo IV, Station Wagon

2.0	107	03/07 → 09/14	B	AOBA, AOBC, TBBA
2.0 EcoBoost	176	07/10 → 09/14	B	TPBA
2.0 Flexifuel	107	03/09 → 09/14		TBBA, TBBB
2.0 LPG	107	07/09 → 09/14		TBBA
2.0 SCTi	149	03/10 → 09/14	B	TNBA

**81804 350981804000**

**FORD**
**Mondeo IV, Station Wagon**

2.3	118	07/07 → 09/14	B	SEBA
-----	-----	---------------	---	------

**Mondeo V, Station Wagon**

2.0 EcoBoost	146	05/15 →	B	TNCC
	149	09/14 →	B	TNCD, TNCF
	176	09/14 →	B	R9CB, R9CF, R9CH

**S-Max**

2.0	107	05/06 →	B	AOWA, AOWB
2.0 EcoBoost	146	07/10 →	B	TNWB
	149	03/10 →	B	TNWA
	176	02/15 →	B	R9CD, R9CI
	176	07/10 →	B	TPWA
2.0 Flexifuel	107	05/06 →		TBWA, TBWB
2.3	118	07/07 →	B	SEWA

**LAND ROVER**
**Discovery Sport**

2.0 4WD	177	12/14 →	B	204PT
---------	-----	---------	---	-------

**Freelander II**

2.0 Si4 4x4	177	10/11 → 10/14	B	204PT
-------------	-----	---------------	---	-------

**Range Rover Evoque, Cabrio**

2.0 4x4	177	06/11 →	B	204PT
---------	-----	---------	---	-------

**MAZDA**
**3 I, Saloon**

2.0	110	10/03 → 06/09	B	LF17
2.3	118	03/04 → 03/09	B	L3-VE
	126	06/00 → 03/03	B	L3-VE
2.3 DiSi Turbo MPS	184	06/06 → 06/09	B	L3YH
2.3 MPS Turbo	191	12/06 → 06/09	B	L3-VDT, L3N9
2.3 MZR	115	03/04 → 03/09	B	L3-VE
2.3 MZR Sport	126	10/03 → 06/09	B	L3YS, L3YT

**3 II, Saloon**

2.0 MZR	110	06/09 →	B	LF-DE, LF17
2.0 MZR DISI	111	06/09 →	B	LF5H, LF5W
2.3 MPS Turbo	191	06/09 →	B	L3-VDT, L3KG

**5 I**

1.8	85	03/05 →	B	L823
2.0	107	03/05 →	B	LFF7
2.3	122	02/05 →	B	

**81804 350981804000**

**MAZDA**
**5 II**

1.8 MZR	85	09/10 →	B	L850
2.0	106	01/11 →	B	LFZB
	110	09/10 →	B	LF5H

**6 I, Hatchback, Station Wagon**

1.8	88	08/02 → 08/07	B	L813
	88	08/02 → 08/07	B	L813, L823, L828
2.0	104	06/02 → 08/07	B	LF17, LF18
	108	03/05 → 08/07	B	LFF7
2.3	122	06/02 → 08/07	B	L3C1
2.3 AWD	119	11/02 → 08/07	B	L3C1
2.3 MPS Turbo	191	12/05 → 08/07	B	L3KG
2.5	125	08/07 →	B	L5-VE

**6 II, Hatchback, Station Wagon**

1.8 MZR	88	08/07 →	B	L813
2.0 MZR	108	08/07 →	B	LF17
	114	01/10 →	B	LF-DE
2.5 MZR	125	08/07 →	B	L5-VE

**CX - 7**

2.3 MZR	190	10/07 →	B	L3-VDT
DISI Turbo	191	09/09 →	B	L3-VDT

**MPV**

2.3	104	07/02 → 02/06	B	L3
-----	-----	---------------	---	----

**MX - 5 III**

1.8	93	03/05 →	B	L8-DE, L828
2.0	118	09/08 →	B	LF-DE, LF62

**Premacy**

2.3 SVT	122	02/05 → 03/05	B	L333
---------	-----	---------------	---	------

**Tribute**

2.3 AWD	110	04/04 → 05/08	B	L3-VE
2.3 GX	110	12/03 → 10/04	B	L3-VE

**VOLVO**
**C 30**

1.8	92	10/06 → 12/12	B	B4184S11
1.8 FlexFuel	92	01/07 → 12/12		B4184S8
2.0	107	10/06 → 12/12	B	B4204S3
2.0 FlexFuel	107	01/10 → 12/12		B4204S4

**S 40 II**

2.0	107	10/06 →	B	B4204S3
2.0 F	107	10/09 →	FF	B4204S4

## 81804 350981804000



### VOLVO

#### S 60 II

2.0 T	149	04/10 →	B	B4204T6
T5	177	04/10 →	B	B4204T7
T6 AWD	224	04/10 →	B	B6304T4

#### S 80 II

2.0	107	01/08 →	B	B4204S3
2.0 FlexFuel	107	01/08 →		B4204S4
2.0 T	149	01/10 →	B	B4204T6
T5	177	10/10 →	B	B4204T7

#### V 50

1.8	92	04/04 →	B	B4184S11
1.8 FlexFuel	92	01/05 →		B4184S8
2.0	107	10/06 →	B	B4204S3
2.0 FlexFuel	107	01/10 →		B4204S4

#### V 60

2.0 T	149	09/10 →	B	B4204T6
T5	177	09/10 →	B	B4204T7

#### V 70 III

2.0	107	10/07 →	B	B4204S3
2.0 FlexiFuel	107	01/08 →		B4204S4
2.0 T	149	01/10 →	B	B4204T6
T5	177	01/10 →	B	B4204T7

#### XC 60

2.0 T	149	03/10 →	B	B4204T6
T5	177	09/10 →	B	B4204T7

## 81805 350981805000



**ALBERINO**

Diametro Alberino 10.8

Posizione Attacco 66.7

Diametro Girante Ø80

N° Alette Girante 8

Posizione Girante 16.2



### FORD

#### Mondeo III, Station Wagon

2.0 16V DI / TDDi / TDCi	66	10/00 → 03/07	D	D5BA, SDBA
2.0 16V TDDi / TDCi	85	10/00 → 03/07	D	D6BA, HJBA, HJBB, HJBC
2.0 TDCi	96	10/01 → 03/07	D	FMBA, N7BA

## 81805 350981805000



### FORD

#### Mondeo III, Station Wagon

2.2 TDCi	110	09/04 → 03/07	D	QJBC, QJBD
	114	09/04 → 03/07	D	QJBA, QJBB

#### Transit VII

2.0 DI	55	08/00 → 05/06	D	D3FA
	63	08/00 → 05/06	D	F3FA
	74	08/00 → 05/06	D	ABFA
2.0 TDCi	92	08/02 → 05/06	D	FIFA
	92	08/02 → 05/06	D	FIFA

### JAGUAR

#### X Type, Estate

2.0 D	96	07/03 → 11/09	D	FMBA, FMBB, R4-X404
	107	01/07 → 11/09	D	LJ46G
2.2 D	114	10/05 → 11/09	D	LJ46G

## 81806 350981806000

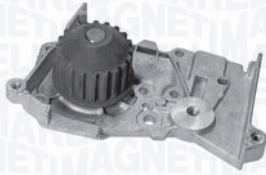

**PULEGGIA**

Diametro Puleggia Ø59.26

Numero Denti/Gole Puleggia 20

Altezza Puleggia 30.5

Posizione Attacco 49.7

Diametro Girante Ø59.5

N° Alette Girante 8

Posizione Girante 24.8



### DACIA

#### Duster

1.6 16V	77	04/10 →	B	K4M690, K4M696
1.6 16V 4x4	77	06/10 →	B	K4M606
1.6 16V Hi-Flex	77	08/10 →		K4M696
1.6 16V LPG	77	04/11 →		K4M696

#### Logan

1.6 16V	77	01/13 →	B	K4M842
---------	----	---------	---	--------

#### Logan MCV

1.6 16V	77	02/07 →	B	K4M690, K4M696
1.6 16V Hi-Flex	77	11/09 →		K4M690, K4M694

**81806 350981806000**

**DACIA**
**Logan, Station Wagon, Van**

1.6 16V	77	02/06 →	B	K4M690, K4M696
1.6 16V Flexifuel	77	07/10 →		K4M696

**Sandero I**

1.6 16V	77	07/11 →	B	K4M690
1.6 16V Bifuel	77	01/11 →	BF	K4M690, K4M694, K4M696

**Sandero II**

1.6	61	11/12 →	B	K7M812
1.6 16V	77	01/13 →	B	K4M842, K4M845

**NISSAN**
**Kubistar**

1.6 16V	70	08/03 → 10/09	B	K4M752
---------	----	---------------	---	--------

**RENAULT**
**Clio II**

1.4 16V	70	10/99 → 09/04	B	K4J712, K4J713
	72	08/00 →	B	K4J710, K4J711, K4J712, K4J713
1.6 16V	79	09/98 →	B	K4M708, K4M740, K4M742, K4M743, K4M744, K4M745, K4M748
1.6 Hi-Flex	86	01/05 → 02/10		K4M748

**Clio III, Grandtour**

1.4 16V	72	02/10 →	B	K4J780
1.6 16V	65	06/05 →	B	K4M804
	82	02/08 →	B	K4M800, K4M801
	94	11/08 →	B	K4M862
1.6 16V GT	94	06/09 →	B	K4M862
1.6 Hi-Flex	86	05/05 → 02/10		K4M748

**Duster**

1.6 16V	75	02/12 →	B	K4M616
---------	----	---------	---	--------

**Fluence**

1.6 16V	82	02/10 →	B	K4M838
	81	02/10 →	B	K4M838, K4M839

**81806 350981806000**

**RENAULT**
**Grand Scénic II**

1.6	77	06/06 →	B	K4M788
	82	06/06 → 11/08	B	K4M812
	83	04/04 →	B	K4M761, K4M782

**Grand Scénic III**

1.6 16V	81	02/09 →	B	K4M858
1.6 16V Bifuel	81	02/09 →	BF	K4M866

**Kangoo I, Van**

1.6 16V	70	06/01 →	B	K4M706, K4M750, K4M752, K4M753
	70	10/01 →	B	K4M706, K4M752
1.6 16V 4x4	70	10/01 →	B	K4M750, K4M752, K4M753
1.6 16V bivalent	60	06/05 →		K4M850

**Kangoo II, Be Bop, Van**

1.6	78	02/09 →	B	K4M830
1.6 16V	78	02/08 →	B	K4M830
	78	02/08 →	B	K4M830, K4M831
1.6 16V Hi-Flex	78	02/08 →		K4M834, K4M850
1.6 16V LPG	72	02/08 →		K4M834

**Laguna I, Grantour**

1.6 16V	79	11/97 → 03/01	B	K4M720, K4M724
---------	----	---------------	---	-------------------

**Laguna II, Grantour**

1.6 16V	82	02/05 →	B	K4M716
	79	03/01 →	B	K4M710, K4M714
	82	02/05 →	B	K4M716
1.6 FlexFuel	76	06/01 → 10/03		K4M718
1.8 16V	85	03/01 →	B	F4P770, F4P771, F4P773, F4P774, F4P775

M: F4P 775

**Laguna III, Grantour, Coupé**

1.6 16V	81	10/07 →	B	K4M824
---------	----	---------	---	--------

**81806**
**350981806000**

**RENAULT**
**Logan I, Station Wagon**

1.6	77	04/07 →	B	K4M690
-----	----	---------	---	--------

**Logan I, Station Wagon, Express**

1.6	77	04/07 →	B	K4M697
-----	----	---------	---	--------

**Megane I, Coach, Cabrio, Scénic, Station Wagon**

1.4 16V	70	03/99 → 08/03	B	K4J714, K4J750
---------	----	---------------	---	-------------------

1.6 16V	79	03/99 → 08/03	B	K4M700, K4M701, K4M704, K4M708
	79	03/99 → 08/03	B	K4M700, K4M701, K4M708

1.6 LPG	80	10/00 → 08/02		K4M704
---------	----	---------------	--	--------

**Megane II, Station Wagon, Coupé-Cabrio**

1.4	60	09/03 →	B	K4J732
	72	08/03 → 07/09	B	K4J730, K4J740

1.4 16V	60	10/03 → 02/08	B	K4J732
	72	11/02 → 02/08	B	K4J730, K4J740

1.6	75	09/03 →	B	K4M768
	77	05/05 →	B	K4M762
	77	06/05 → 02/08	B	K4M788

1.6	83	09/03 → 03/09	B	K4M760, K4M761
	77	05/05 → 07/09	B	K4M762

1.6 16V	82	01/06 → 06/08	B	K4M760, K4M761, K4M812, K4M813
	82	01/06 → 06/08	B	K4M760, K4M812, K4M813

1.6 16V	82	01/06 →	B	K4M812, K4M813
	83	11/02 → 02/08	B	K4M760

1.6 16V Hi-Flex	77	02/08 → 07/09		K4M856
--------------------	----	---------------	--	--------

1.6 Flex-Fuel	77	01/07 → 02/08		K4M788
------------------	----	---------------	--	--------

**81806**
**350981806000**

**RENAULT**
**Megane III, Station Wagon, Coupé, CC**

1.6 16V	82	11/08 →	B	K4M858, K4M866
	74	11/08 →	B	K4M848
	81	06/10 →	B	K4M858

1.6 16V Bifuel	81	11/08 →	BF	K4M866
-------------------	----	---------	----	--------

1.6 TCe	96	01/11 →	B	
---------	----	---------	---	--

**Modus**

1.4	72	12/04 →	B	K4J770, K4J780
-----	----	---------	---	-------------------

1.6	65	12/04 →	B	K4M794
	82	12/04 →	B	K4M790, K4M791, K4M800, K4M801

1.6	82	12/04 →	B	K4M790, K4M791, K4M800, K4M801
-----	----	---------	---	---

**Scénic I**

1.4 16V	70	09/99 → 08/03	B	K4J714, K4J750
---------	----	---------------	---	-------------------

1.6	79	09/99 → 09/03	B	K4M700, K4M706
-----	----	---------------	---	-------------------

1.6 BiFuel	79	09/99 → 04/01	BF	K4M704
------------	----	---------------	----	--------

**Scénic II**

1.4	72	06/03 →	B	K4J730, K4J740, K4J770
-----	----	---------	---	------------------------------

1.6	77	06/06 →	B	K4M788
	83	06/03 →	B	K4M761, K4M782

1.6 16V	82	10/05 →	B	K4M706, K4M766, K4M812, K4M813
---------	----	---------	---	---

1.6 16V	82	10/05 →	B	K4M706, K4M766, K4M812, K4M813
---------	----	---------	---	---

**Scénic III**

1.6 16V	81	02/09 →	B	K4M858
1.6 E85	81	02/09 →	FF	K4M866

**Thalia I**

1.4 16V	72	08/00 →	B	K4J712
1.6 16V	79	04/02 →	B	K4M740

**Thalia II**

1.6 16V	77	09/08 →	B	K4M743
---------	----	---------	---	--------

**Twingo II**

1.6 RS	98	05/08 →	B	K4M854
--------	----	---------	---	--------

**Wind**

1.6	98	07/10 →	B	K4M854
-----	----	---------	---	--------

**81807**
**350981807000**

**FLANGIA**

Numero Fori Flangia	3
Numero Fori Flangia (Serie 2)	3
Dimensione Fori Flangia	M6×1
Dimensione Fori Flangia (Serie 2)	Ø6
Posizione Attacco	61.6
Diametro Centraggio	Ø40
Diametro Girante	Ø60
N° Alette Girante	8
Posizione Girante	30.6

**KW**

**SEAT**
**Arosa**

1.0	37	10/98 → 01/01	B	AHT	
	37	05/97 → 06/04	B	AER, ALD, ALL, ANV, AUC	→ 11-1999, M: AHT

**VOLKSWAGEN**
**Lupo I**

1.0	37	10/98 → 05/00	B	AHT	
	37	09/98 → 07/05	B	AER, ALD, ALL, ANV, AUC	M: AHT

**81808**
**350981808000**

**FLANGIA**

Numero Fori Flangia	3
Numero Fori Flangia	3
Dimensione Fori Flangia	M6×1
Posizione Attacco	56.5
Diametro Mozzo	Ø28
Diametro Girante	Ø60
N° Alette Girante	6
Posizione Girante	10.2

**KW**

**DAIHATSU**
**Copen**

1.3	64	03/06 → 09/12	B	K3-VE	Flange: 3 holes
-----	----	---------------	---	-------	-----------------

**Materia**

1.3	67	10/06 →	B	K3-VE	Flange: 3 holes
1.3 DVVT Turbo	95	10/06 →	B	K3-VET	Flange: 3 holes
1.5	76	10/06 →	B	3SZ-VE	Flange: 3 holes
1.5 ECO 4WD	76	10/06 →	B	3SZ-VE	Flange: 3 holes

**Sirion I**

1.3 Sport	75	08/00 → 01/05	B	K3-VE2	Flange: 3 holes
1.3 Sport 4WD	75	08/00 → 03/05	B	K3-VE2	Flange: 3 holes

**81808**
**350981808000**

**KW**

**DAIHATSU**
**Sirion II**

1.3	64	01/05 →	B	K3-VE	Flange: 3 holes
	67	03/08 →	B	K3-VE	Flange: 3 holes
1.3 4WD	64	04/05 →	B	K3-VE	Flange: 3 holes
	67	03/08 →	B	K3-VE	Flange: 3 holes
1.5	76	03/08 →	B	3SZ-VE	Flange: 3 holes
1.5 4WD	76	05/06 → 10/08	B	3SZ-VE	Flange: 3 holes

**Terios II**

1.3 VVT-i	63	11/05 →	B	K3-VE	Flange: 3 holes
1.3 VVT-i 4x4	63	11/05 →	B	K3-VE	Flange: 3 holes
1.5 4x4	77	05/06 →	B	3SZ-VE	Flange: 3 holes
1.5 VVT-i	75	09/10 →	B	3SZ-VE	Flange: 3 holes
	77	11/05 →	B	3SZ-VE	Flange: 3 holes
1.5 VVT-i 4x4	75	09/10 →	B		Flange: 3 holes

**YRV**

1.3	64	02/01 →	B	K3-VE	Flange: 3 holes
1.3 4WD	64	02/01 →	B	K3-VE	Flange: 3 holes
1.3 GTi	95	07/02 →	B	K3-VET	Flange: 3 holes

**TOYOTA**
**Yaris I**

1.0 16V	48	03/03 → 09/05	B	1SZ-FE	Flange: 3 holes
	50	04/99 → 09/05	B	1SZ-FE	Flange: 3 holes

**81809**
**350981809000**

**FLANGIA**

Numero Fori Flangia	3
Dimensione Fori Flangia	M6×1
Posizione Attacco	50.5
Diametro Mozzo	Ø28
Diametro Girante	Ø56.5
N° Alette Girante	6
Posizione Girante	21.2

**KW**

**TOYOTA**
**Corolla VII, Liftback, Station Wagon, Verso**

1.4 D	66	07/04 → 02/07	D	1ND-TV	
1.4 D4-D	66	07/04 → 02/07	D	1ND-TV	
	66	07/04 → 07/07	D	1ND-TV	

**Prius I**

1.5 Hybrid	53	05/00 → 01/04		1NZ-FXE	
------------	----	---------------	--	---------	--

**Prius II**

1.5	57	08/03 → 03/09		1NZ-FXE	
-----	----	---------------	--	---------	--

**81809**
**350981809000**

**TOYOTA**
**Urban Cruiser**

1.5 VVTi	80	07/07 →	B	1NZ-FE
1.5 VVTi 4WD	76	04/09 →	B	1NZ-FE

**Verso S**

1.5	80	11/10 →	B	1NZ-FE
1.5 4WD	76	11/10 →	B	1NZ-FE

**Yaris I**

1.3	64	04/02 → 09/05	B	2SZ-FE
1.3 16V	63	11/99 → 09/05	B	2NZ-FE, 2SZ-FE
1.4 D-4D	55	12/01 → 09/05	D	1ND-TV
1.5 TS	77	01/03 → 09/05	B	1NZ-FE
1.5 VVT-i TS	78	04/01 → 09/05	B	1NZ-FE
	110	03/03 → 07/05	B	1NZ-FE

**Yaris II**

1.3	64	08/07 →	B	2NZ-FE, 2SZ-FE
1.3 4WD	64	08/07 →	B	2NZ-FE
1.5	80	08/07 →	B	1NZ-FE
	81	08/07 →	B	1NZ-FE
	80	11/05 →	B	1NZ-FE

**Yaris III**

1.3 VVT-i	63	12/10 →	B	2NZ-FE
-----------	----	---------	---	--------

**Yaris Verso**

1.3	62	11/02 → 09/05	B	2NZ-FE
	63	08/99 → 10/02	B	2NZ-FE
1.4 D-4D	55	12/01 → 09/05	D	1ND-TV
1.5	77	05/03 → 09/05	B	1NZ-FE
	78	03/00 → 09/05	B	1NZ-FE

**81810**
**350981810000**

**PULEGGIA**

Diametro Puleggia	Ø52
Altezza Puleggia	32.8
Posizione Attacco	50.5
Diametro Girante	Ø70.3
N° Alette Girante	10
Posizione Girante	7.8

**DACIA**
**Logan**

1.5 dCi	55	10/12 →	D	K9K612
	63	01/13 →	D	K9K830

**Logan MCV**

1.5 dCi	55	02/13 →	D	K9K612
	63	02/13 →	D	K9K830
	66	02/13 →	D	K9K612

**Sandero II**

1.5 dCi	55	10/12 →	D	K9K612
	66	10/12 →	D	K9K612

**NISSAN**
**Almera II, Hatchback**

1.5 dCi	60	01/03 →	D	K9K722
---------	----	---------	---	--------

**Kubistar**

1.5 dCi	42	08/03 → 10/09	D	K9K710, K9K714
	45	08/05 → 10/09	D	K9K710, K9K714
	48	08/03 → 10/09	D	K9K704
	60	08/03 → 10/09	D	K9K722

**Micra III (K12), C+C**

1.5 dCi	48	01/03 → 06/10	D	K9K704
	60	09/03 → 06/10	D	K9K722

**RENAULT**
**Clio II**

1.5 dCi	50	04/04 →	D	K9K714
	59	06/01 → 10/04	D	K9K702
	60	11/03 →	D	K9K702, K9K710, K9K716
	48	06/01 →	D	K9K700, K9K704
	59	06/01 → 10/03	D	K9K702
	60	06/01 →	D	K9K702

**Grand Scénic II**

1.5 dCi	74	04/04 →	D	K9K728
	78	05/05 →	D	K9KP732



**81810 350981810000**

**RENAULT**
**Kangoo I, Van**

1.5 dCi	42	07/03 →	D	K9K704	→ 03-2004
	45	04/05 → 06/10	D	K9K700, K9K702	
	45	10/05 →	D	K9K716	
	50	06/05 →	D	K9K714	
	42	12/02 →	D	K9K704	→ 03-2004
	48	12/01 →	D	K9K700, K9K702, K9K704	→ 03-2004
	48	12/01 →	D	K9K700, K9K704	→ 03-2004
	50	06/05 →	D	K9K714	
	60	07/02 →	D	K9K702, K9K710	→ 03-2004
	62	06/05 →	D	K9K718	

**Logan I, Station Wagon, Express**

1.5 dCi	50	04/07 →	D	K9K792	
---------	----	---------	---	--------	--

**Megane II, Station Wagon, Coupé-Cabrio**

1.5 dCi	60	08/03 → 05/06	D	K9K722	→ 03-2004
	60	11/02 → 02/08	D	K9K722	→ 03-2004

**Megane III, Station Wagon, Coupé, CC**

1.5 dCi	63	03/09 →	D	K9K830	
---------	----	---------	---	--------	--

**Modus**

1.5 dCi	50	12/04 →	D	K9K762, K9K768	
	63	12/04 →	D	K9K760, K9K766	

**Scénic II**

1.5 dCi	60	06/03 →	D	K9K722	→ 03-2004
	74	11/03 →	D	K9K728, K9K729	→ 03-2004

**Thalia I**

1.5 dCi	48	04/02 →	D	K9K700	
---------	----	---------	---	--------	--

**Thalia II**

1.5 dCi	48	01/09 →	D	K9K700	
---------	----	---------	---	--------	--

**Twingo II**

1.5 dCi	62	04/08 →	D	K9K718	
---------	----	---------	---	--------	--

**SUZUKI**
**Jimny**

1.5 DDiS 4WD	48	12/03 →	D	K9K700	
-----------------	----	---------	---	--------	--

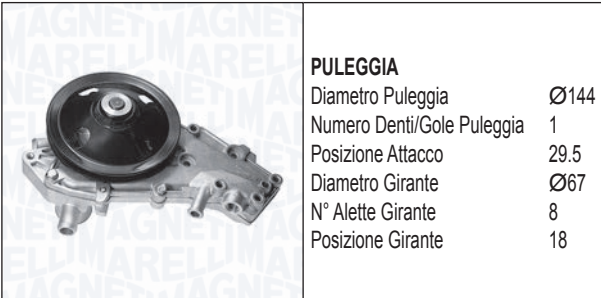
**81811 350981811000**

**RENAULT**
**19 I, Chamade, Cabrio**

1.2	40	01/88 → 12/92	B	C1G730	(+)COP
1.4	43	01/89 → 04/92	B	C2J772, C3J710	(+)COP

**19 II, Chamade, Cabrio**

1.2	40	04/92 → 12/95	B	C1G730	(+)COP
1.4	43	04/92 → 12/95	B	C3J710	(+)COP

**21, Station Wagon**

1.4	51	09/89 → 05/93	B	C2J770	(+)COP
-----	----	---------------	---	--------	--------

**Clio I**

1.1	34	01/91 → 09/98	B	C1E700	(+)COP
	34	01/91 → 09/98	B	C1E700	(+)COP, → 05-1994, M: C1E700
	36	04/92 → 08/92	B	C1E700	(+)COP, → 05-1994, M: C1E700

**Rapid**

1.0	27	02/86 → 05/92	B	C1C706	(+)COP, (-)AC
1.1	33	07/85 → 04/95	B	C1E750, C1E752, C1E754, C1E756, C1E760, C1E762, C1E792	(+)COP, (-)AC
				C3G710, C3G712	(+)COP, (-)AC
1.2	40	09/91 → 03/98	B	C3G710, C3G712	(+)COP, (-)AC
1.4	43	07/85 → 03/98	B	C1J768, C1J780, C3J700, C3J702, C3J760, C3J762	(+)COP, (-)AC
				C2J784	(+)COP, (-)AC

## 81811 350981811000



### RENAULT

#### Super 5

1.1	33	01/86 → 03/95	B	C1E750, C1E752, C1E756, C1E760	(+)COP, (-)AC
	34	10/84 → 12/96	B	C1E750, C1E752, C1E754	(+)COP, (-)AC
1.2	40	01/87 → 08/90	B	C1G702, C1G720, C1G722	(+)COP, (-)AC
	44	01/87 → 12/96	B	C1G702	(+)COP, (-)AC
1.4	43	10/84 → 12/96	B	C1J768, C1J780, C3J700, C3J702, C3J760	(+)COP, (-)AC
	44	06/87 → 08/90	B	C2J784	(+)COP, (-)AC
1.4 Turbo	88	04/85 → 08/90	B	C1J782, C1J784, C1J788	(+)COP, (-)AC
1.4 Turbo GT	118	01/85 → 05/91	B	840730	(+)COP, (-)AC

## 81812 350981812000



### FLANGIA

Numero Fori Flangia	3
Dimensione Fori Flangia	M6×1
Posizione Attacco	74
Diametro Girante	Ø66.8
N° Alette Girante	8
Posizione Girante	16.7



### ALFA ROMEO

#### 159, Sportwagon

1.9 JTS	118	09/05 → 11/11	B	939A6.000
2.2 JTS	136	09/05 → 11/11	B	939A5.000

#### Brera

2.2 JTS	136	01/06 → 06/10	B	939A5.000
---------	-----	---------------	---	-----------

#### Spider V

2.2 JTS	136	03/06 → 06/10	B	939A5.000
---------	-----	---------------	---	-----------

## 81812 350981812000



### CHEVROLET

#### Captiva

2.4	123	03/11 →	B	A24XE, LE5
2.4 4WD	123	03/11 →	B	A24XE, LE5

#### HHR

2.4	125	10/07 → 12/11	B	LE5
-----	-----	---------------	---	-----

#### Malibu

2.4	123	01/12 →	B	LE9
	125	01/12 →	B	LE9

### FIAT

#### Croma II

2.2 16V	108	06/05 →	B	194A1.000
---------	-----	---------	---	-----------

### OPEL

#### Antara

2.4	123	12/10 →	B	A24XE
2.4 4x4	123	12/10 →	B	A24XE

#### Astra G, Station Wagon, Coupé, Cabrio, Van

2.2 16V	108	06/00 → 01/05	B	Z22SE
---------	-----	---------------	---	-------

#### Astra J, Station Wagon, GTC

2.0	206	04/12 →	B	A20NFT, B20NFT
-----	-----	---------	---	-------------------

#### GT II

2.0	194	06/07 →	B	LNF, Z20NHH → T: 7Y999999
-----	-----	---------	---	---------------------------

#### Insignia, Station Wagon

2.0 E85 Turbo	162	09/10 →	FF	A20NFT, A20NHT
	162	09/10 →	FF	A20NHT
2.0 Turbo	162	07/08 →	B	A20NHT
2.0 Turbo 4x4	162	07/08 →	B	A20NHT
	184	09/11 →	B	A20NFT
2.0 Turbo E85	162	07/08 →	FF	A20NFT, A20NHT

#### Signum

2.0 Turbo	129	05/03 →	B	Z20NET
2.2 direct	114	05/03 →	B	Z22YH

#### Speedster

2.2	108	09/00 →	B	Z22SE
-----	-----	---------	---	-------

#### Vectra B, Station Wagon

2.2 i 16V	108	09/00 → 04/02	B	C22SEL, Z22SE
-----------	-----	---------------	---	------------------

#### Vectra C, Station Wagon

2.0 16V Turbo	129	03/03 →	B	Z20NET
2.0 Turbo	129	10/03 →	B	Z20NET
2.2 16V	108	04/02 →	B	Z22SE
2.2 direct	114	10/03 →	B	Z22YH

**81812 350981812000**

**OPEL**
**Zafira A**

2.2 16V 108 09/00 → 06/05 B Z22SE

**Zafira B, Van**

2.2 110 07/05 → B Z22YH

**SAAB**
**9-3 II, Station Wagon, Cabrio**

1.8t 110 09/02 → B B207E

1.8t 110 01/07 → B207E

BioPower 129 05/09 → B207L

1.8t 2.0 110 03/05 → B B207E

110 03/05 → B B207E

129 08/03 → B B207L

2.0 t 129 09/02 → B B207L, B207M

147 02/09 → B B207M

154 09/02 → B B207R

177 05/09 → B B207R

2.0 t 110 01/07 → B207E

129 01/07 → B207L

BioPower 145 06/07 → B207R

147 05/09 → B207M

154 09/02 → B207R

2.0 t XWD 154 06/08 → B B207R

2.0 Turbo XWD 154 01/08 → B B207R

**9-3 X**

2.0 t BioPower XWD 154 02/09 → B207R

2.0 t XWD 154 02/09 → B B207R

**9-5 II, Station Wagon**

2.0 t BioPower 162 05/10 → 01/12 A20NFT

2.0 t BioPower XWD 162 05/10 → 01/12 A20NHT

2.0 Turbo 162 05/10 → 01/12 B A20NHT

2.0 Turbo XWD 162 05/10 → 01/12 B A20NHT

**VAUXHALL**
**ASTRA**

2.2 16V 108 03/01 → 05/05 B Z22SE

**SIGNUM**

2.2 i 114 05/03 → 05/08 B Z22YH

**81812 350981812000**

**OPEL**
**ZAFIRA**

2.2 16V 108 11/98 → 08/04 B Z22SE

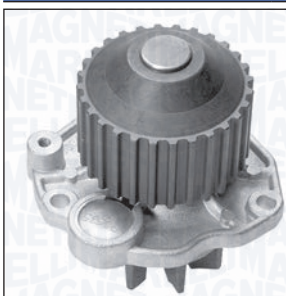
**81813 350981813000**

**PULEGGIA**

Diametro Puleggia Ø69.7

Numero Denti/Gole Puleggia 28

Altezza Puleggia 36.1

Posizione Attacco 54.15

Diametro Girante Ø59.5

N° Alette Girante 8

Posizione Girante 49.4

**CITROËN**
**C 5 I, Break**

3.0 Carlsson 173 09/03 → 08/04 B XFX (ES9J4S)

3.0 V6 152 03/01 → 08/04 B XFX (ES9J4S)

**C 5 II, Break**

3.0 173 09/04 → B XFX (ES9J4S)

155 10/04 → 04/07 B XFU (ES9A)

3.0 V6 152 09/04 → B XFU (ES9A)

152 09/04 → B XFU (ES9A), XFX (ES9J4S)

**C 5 III, Break**

3.0 V6 155 02/08 → B XFU (ES9A)

**C 6**

3.0 V6 155 09/05 → B XFV (ES9A), XFX (ES9J4S)

**C 8**

3.0 V6 150 07/02 → B XFX (ES9J4S)

**FIAT**
**Ulysse II**

3.0 150 08/02 → 06/11 B XFW

**LANCIA**
**Phedra**

3.0 V6 150 09/02 → 11/10 B ES9J4S

**PEUGEOT**
**407, Station Wagon, Coupé**

3.0 155 05/04 → B XFW (ES9A)

3.0 V6 152 03/00 → 05/04 B XFX (ES9J4S) PROD →: 8555

155 10/05 → B XFW (ES9A)

## 81813 350981813000



### PEUGEOT

#### 607

3.0 V6 24V	152	02/00 →	B	XFV (ES9A), XFX (ES9J4S)
	155	03/04 →	B	XFX (ES9J4S)

#### 807

3.0 V6	150	06/02 →	B	XFX (ES9J4S)
--------	-----	---------	---	--------------

### RENAULT

#### Avantime

3.0 V6	152	09/01 → 05/03	B	L7X720, L7X721
--------	-----	---------------	---	-------------------

#### Clio II

3.0 V6	166	11/00 → 12/02	B	L7X760
Sport	187	12/02 →	B	L7X762

#### Laguna II, Grantour

3.0 V6 24V	152	03/01 →	B	L7X731
	152	03/01 →	B	L7X731

## 81814 350981814000



**PULEGGIA**

Diametro Puleggia Ø54

Altezza Puleggia 37

Posizione Attacco 48.5

Diametro Girante Ø70.3

N° Alette Girante 10

Posizione Girante 7.8



### MITSUBISHI

#### Carisma

1.9 DI-D	85	09/00 → 06/06	D	F9Q2
	75	09/00 → 06/06	D	F9Q1

#### Space Star

1.9 DI-D	85	10/02 → 12/04	D	F9Q2
	75	02/01 → 12/04	D	F9Q1

### NISSAN

#### Interstar

dCi 80	60	07/02 →	D	F9Q772
--------	----	---------	---	--------

#### Primastar

2.0	88	02/03 →	B	F4R720
	88	03/01 →	B	F4R720, F4R722
dCi 100	74	03/01 →	D	F9Q760
dCi 80	60	03/01 →	D	F9Q762

## 81814 350981814000



### OPEL

#### Movano A

1.9 DTI	60	10/01 →	D	F9Q772, F9Q774
---------	----	---------	---	-------------------

#### Vivaro

1.9 DI	60	08/01 →	D	F9Q762
	60	08/01 →	D	F9Q762, F9Q774
1.9 DTI	74	08/01 →	D	F9Q760
2.0 16V	88	08/01 →	B	F4R720
2.0 ECOTEC	86	08/06 →	B	F4R820

### RENAULT

#### Avantime

2.0 16V Turbo	120	11/01 → 05/03	B	F4R760, F4R761
---------------	-----	---------------	---	-------------------

#### Clio III, Grandtour

2.0 16V Sport	145	02/06 →	B	F4R830
	148	09/08 →	B	F4R830

#### Duster

2.0	98	02/12 →	B	F4R403, F4R405
-----	----	---------	---	-------------------

#### Espace IV

1.9 dCi	85	04/03 → 02/05	D	F9Q820
1.9 dCi	88	11/02 →	D	F9Q680, F9Q820, F9Q826
2.0	100	11/02 →	B	F4R792
2.0 Turbo	120	11/02 →	B	F4R794, F4R795, F4R796, F4R797

#### Grand Scénic II

2.0	99	04/04 →	B	F4R770, F4R771
	120	04/04 →	B	F4R776

#### Laguna I, Grantour

1.9 dCi	79	09/99 → 03/01	D	F9Q718
2.0 16V	103	09/99 → 03/01	B	F4R780

**81814**
**350981814000**

**KW**

**RENAULT**
**Laguna II, Grantour**

1.8 16V	86	03/01 →	B	F4P770	
	89	03/01 →	B	F4P770, F4P774	
	85	03/01 →	B	F4P770, F4P771, F4P773, F4P774, F4P775	
	85	03/01 →	B	F4P770, F4P771, F4P774, F4P775	
	86	03/01 →	B	F4P770, F4P774	
	88	03/01 →	B	F4P770, F4P773	
	89	03/01 →	B	F4P770, F4P772	
	1.9 dCi	79	03/01 →	D	F9Q718, F9Q754
85		09/05 →	D	F9Q750	
92		09/05 →	D	F9Q750	
74		10/01 →	D	F9Q752	
74		10/01 →	D	F9Q754	
77		06/01 →	D	F9Q752	
85		08/05 → 09/07	D	F9Q758, F9Q759	
88		03/01 →	D	F9Q650, F9Q670, F9Q674, F9Q750	
88	03/01 →	D	F9Q670, F9Q674, F9Q750		

**81814**
**350981814000**

**KW**

**RENAULT**
**Laguna II, Grantour**

2.0 16V	98	08/02 →	B	F4R714	
	98	10/04 → 09/07	B	F4R714, F4R715	
	125	01/05 →	B	F4R784, F4R786, F4R787	
	150	01/05 →	B	F4R886, F4R887	
2.0 16V IDE	103	04/01 →	B	F5R700, F5R701	
2.0 16V Turbo	120	01/03 →	B	F4R764, F4R765, F4R786, F4R787	

**Laguna III, Grantour, Coupé**

2.0 16V Turbo	125	10/07 →	B	F4R811	
	125	09/08 →	B	F4R811, F4Rt811	
2.0 GT	150	09/08 →	B	F4R800	

**Master II**

1.9 dCi 80	60	11/01 →	D	F9Q772, F9Q774	
------------	----	---------	---	-------------------	--

**Megane I, Coach, Cabrio, Scénic, Station Wagon**

1.9 dCi	75	02/01 → 08/03	D	F9Q732, F9Q733	
	75	02/01 → 08/03	D	F9Q732, F9Q733, F9Q738	

**Megane II, Station Wagon, Coupé-Cabrio**

2.0	99	09/03 → 12/09	B	F4R770, F4R771	
	102	09/03 → 02/07	B	F4R770	
	169	08/06 → 02/08	B	F4R774	
2.0 16V	99	11/02 → 02/08	B	F4R770	
2.0 16V Turbo	120	05/04 → 02/08	B	F4R776	
2.0 Renault Sport	165	05/04 → 10/09	B	F4R774, F4Rt774	

**81814**
**350981814000**

**RENAULT**
**Megane III, Station Wagon, Coupé, CC**

2.0 R.S.	195	11/08 →	B	F4R874
2.0 TCe	140	06/12 →	B	F4R872
	162	09/12 →	B	F4R874
	132	11/08 →	B	F4R870
	132	06/10 →	B	F4R870, F4R872
	184	05/09 →	B	F4R874

**Scénic II**

2.0	99	06/03 →	B	F4R770, F4R771
2.0 16V Turbo	120	05/04 →	B	F4R776

**Trafic II**

1.9 dCi	59	04/01 → 07/03	D	F9Q762
	75	03/01 →	D	F9Q760
1.9 dCi 100	74	03/01 →	D	F9Q760
1.9 dCi 80	60	03/01 →	D	F9Q760, F9Q762
	60	03/01 →	D	F9Q762
2.0	88	03/01 →	B	F4R720
	88	03/01 →	B	F4R720, F4R722
2.0 16V	86	08/06 →	B	F4R820

**Vel Satis**

2.0 16V Turbo	125	04/04 →	B	F4R766, F4R767
	120	06/02 →	B	F4R762, F4R763
2.0 Turbo	108	04/05 →	B	F4R867

**VAUXHALL**
**MOVANO**

1.9 DTI	59	09/00 → 10/01	D	F9Q770
	60	10/01 → 05/10	D	F9Q774

**VIVARO**

1.9 DI	59	08/01 → 12/06	D	F9Q762
1.9 DTI	74	08/01 → 12/06	D	F9Q760

**VOLVO**
**S 40 I**

1.9 DI	75	07/00 → 12/03	D	D4192T4
	85	07/00 → 12/03	D	D4192T3

**V 40 I**

1.9 DI	75	07/00 → 06/04	D	D4192T4
	85	07/00 → 06/04	D	D4192T3

**81815**
**350981815000**

**FLANGIA**

Numero Fori Flangia	4
Dimensione Fori Flangia	M6×1
Posizione Attacco	76.5
Diametro Mozzo	Ø28
Diametro Girante	Ø58
N° Alette Girante	7
Posizione Girante	10

**TOYOTA**
**Carina E (T19), Station Wagon**

1.6	73	12/93 → 09/97	B	4A-FE	(-)COP
	79	01/93 → 09/97	B	4A-FE	(-)COP, → 12-1994
	85	12/93 → 09/97	B	4A-FE	(-)COP
1.6 GLI	79	04/92 → 09/97	B	4A-FE	(-)COP

**Celica V**

1.6 STI	77	10/89 → 11/93	B	4A-FE	(-)COP
---------	----	---------------	---	-------	--------

**Corolla V, Liftback, Station Wagon, Compact**

1.6 GLI	84	07/92 → 04/97	B	4A-FE	(-)COP
1.6 Si	84	09/95 → 04/97	B	4A-FE	(-)COP

**Corolla VI, Liftback, Station Wagon, Compact**

1.6	81	04/97 → 02/00	B	4A-FE	(-)COP
	79	04/97 → 02/00	B	4A-FE	(-)COP
1.6 Aut.	79	04/97 → 02/00	B	4A-FE	(-)COP

**81816**
**350981816000**

**PULEGGIA**

Diametro Puleggia	Ø56
Numero Denti/Gole Puleggia	19
Altezza Puleggia	33.5
Posizione Attacco	52.2
Diametro Girante	Ø64
N° Alette Girante	8
Posizione Girante	47.5

**AUDI**
**A3 I**

1.9 TDI	74	10/00 → 05/03	D	ATD, AXR
	96	08/00 → 05/03	D	ASZ
1.9 TDI quattro	96	08/00 → 05/03	D	ASZ

**81816**
**350981816000**

**KW**

**AUDI**
**A3 II, Sportback, Cabriolet**

2.0 TDI	100	05/03 → 08/12	D	AZV, CBAA, CFFA	
	100	04/08 → 05/13	D	CBAA, CFFA	
	103	06/05 → 06/08	D	BMM	
	103	04/08 → 05/13	D	CBAB, CFFB	
	120	06/06 → 06/08	D	BUY	
	125	03/06 → 08/12	D	BMN, CBBB, CFGB	
2.0 TDI 16V	103	05/03 → 08/12	D	BKD, CBAB, CFFB, CLJA	
2.0 TDI 16V quattro	103	08/04 → 08/12	D	BKD, CBAB, CFFB	
	103	11/05 → 03/13	D	BKD, CBAB, CFFB	M: BKD
2.0 TDI quattro	100	05/03 → 06/08	D	AZV	
	103	01/06 → 06/08	D	BMM	
	125	03/06 → 08/12	D	BMN, CBBB, CFGB	

**A4 I, Avant**

1.9 TDI	85	03/00 → 11/00	D	AJM	
1.9 TDI quattro	85	03/00 → 11/00	D	AJM, ATJ	

**A4 II, Avant, Cabriolet**

1.9 TDI	74	05/01 → 12/04	D	AVB	
	85	06/04 → 12/04	D	BKE	
	96	11/00 → 12/04	D	AVF, AWX	
1.9 TDI quattro	96	11/01 → 12/04	D	AVF	
2.0 TDI	100	01/06 → 03/09	D	BRC	
	103	01/06 → 03/09	D	BPW	

**A4 III, Avant**

1.9 TDI	85	11/04 → 06/08	D	BKE, BRB	
2.0 TDI	89	09/05 → 09/06	D	BVG	
	93	11/05 → 11/06	D	BVF	
	100	11/04 → 06/08	D	BNA, BRF	
	103	11/04 → 06/08	D	BPW	
	120	06/06 → 06/08	D	BVA	
	125	06/06 → 06/08	D	BRD	
2.0 TDI 16V	103	11/04 → 06/08	D	BLB, BRE	
2.0 TDI quattro	103	01/06 → 06/08	D	BPW	
	120	06/06 → 06/08	D	BVA	
	125	06/06 → 06/08	D	BRD	

**81816**
**350981816000**

**KW**

**AUDI**
**A4 IV, Avant, Allroad**

2.0 TDI	88	06/08 → 12/15	D	CAGC, CJCC	
	100	11/07 → 12/15	D	CAGB, CJCB, CSUB	
	105	11/07 → 12/15	D	CAGA, CJCA, CMEA, CMFA	
	120	08/08 → 12/15	D	CAHB, CGLD, CNHC	
	125	01/08 → 03/12	D	CAHA	
	2.0 TDI quattro	100	09/09 →	D	CAGB, CJCB, CSUB
105		11/08 → 12/15	D	CAGA, CJCA	
120		04/09 →	D	CAHB, CGLD, CNHC	
125		01/08 → 03/12	D	CAHA	

**A5, Sportback, Cabriolet**

2.0 TDI	100	09/09 →	D	CAGB, CJCB	
	105	09/09 →	D	CAGA, CJCA, CMEA, CMFA	
	120	08/08 →	D	CAHB, CGLD	
	125	08/08 →	D	CAHA	
2.0 TDI quattro	125	08/08 →	D	CAHA	

**A6 II, Avant**

1.9 TDI	85	07/00 → 01/05	D	AJM	
	96	08/01 → 01/05	D	AVF, AWX	

**A6 III, Avant, Allroad**

2.0 TDI	89	09/05 → 06/06	D	BVG	
	100	07/04 → 03/11	D	BNA, BRF, CAGB	
	103	07/04 → 10/08	D	BLB, BRE	
	120	04/09 → 03/11	D	CAHB	
	125	11/08 → 03/11	D	CAHA	

**TT II, Roadster**

2.0 TDI quattro	125	06/08 → 06/14	D	CBBB, CFGB	
-----------------	-----	---------------	---	------------	--

**CHRYSLER**
**Sebring III, Cabrio**

2.0 CRD	103	07/07 → 12/10	D	ECD	
---------	-----	---------------	---	-----	--

**DODGE**
**Avenger**

2.0 CRD	103	06/07 →	D	ECD	
---------	-----	---------	---	-----	--

**Caliber**

2.0 CRD	103	06/06 →	D	ECD, ECE	
---------	-----	---------	---	----------	--

**81816 350981816000**

**DODGE**
**Journey**

2.0 CRD	103	06/08 →	D	ECE
---------	-----	---------	---	-----

**FORD**
**Galaxy I**

1.9 TDI	66	03/95 → 05/06	D	1Z, AHU, ANU	05-2000 →, M: ANU
	85	04/00 → 05/06	D	AUY	M: VW19NPD

**JEEP**
**Compass**

2.0 CRD	103	08/06 →	D	ECD, ECE
---------	-----	---------	---	----------

2.0 CRD 4x4	103	09/06 →	D	ECE
-------------	-----	---------	---	-----

**Patriot**

2.0 CRD	103	02/07 →	D	ECD, ECE
---------	-----	---------	---	----------

2.0 CRD 4x4	103	02/07 →	D	ECD, ECE
-------------	-----	---------	---	----------

**MITSUBISHI**
**Grandis II**

2.0 DI-D	100	09/05 →	D	BSY
----------	-----	---------	---	-----

	103	02/07 →	D	BWC
--	-----	---------	---	-----

**Lancer VIII, Station Wagon, Sportback**

2.0 DI-D	103	06/08 →	D	BKD, BWC
----------	-----	---------	---	----------

**Outlander II, Van**

2.0 DI-D	103	02/07 → 11/12	D	BSY
----------	-----	---------------	---	-----

**SEAT**
**Alhambra I**

1.9 TDI	66	04/96 → 03/10	D	1Z, AHU, ANU	08-2000 →
	85	06/00 → 03/10	D	AUY, BVK	
	110	05/05 → 05/07	D	BTB	

1.9 TDI 4motion	85	06/00 → 03/10	D	AUY, BVK
-----------------	----	---------------	---	----------

2.0 TDI	103	11/05 → 03/10	D	BRT
---------	-----	---------------	---	-----

**Altea, Altea XL**

2.0 TDI	100	03/04 → 05/09	D	AZV
	103	11/05 →	D	BMM
	125	03/06 →	D	BMN, CEGA

2.0 TDI 16V	103	03/04 →	D	BKD, CFHC
-------------	-----	---------	---	-----------

2.0 TDI 4x4	103	06/07 →	D	BMM
	125	06/07 →	D	BMN, CEGA, CFJA

**Exeo, Exeo ST**

2.0 TDI	88	12/08 →	D	CAGC, CJCC
	105	12/08 →	D	CAGA, CJCA
	125	02/09 →	D	CAHA, CGLB

**81816 350981816000**

**SEAT**
**Ibiza IV**

1.9 TDI Cupra R	118	03/04 → 02/08	D	BPX, BUK
-----------------	-----	---------------	---	----------

**Leon I**

1.9 TDI	74	10/05 → 06/06	D	AXR
	96	05/03 → 06/06	D	ASZ
	110	09/00 → 06/06	D	ARL

1.9 TDI Syncro	110	05/02 → 06/06	D	ARL
----------------	-----	---------------	---	-----

**Leon II**

2.0 TDI	100	07/05 → 05/10	D	AZV
	103	10/05 → 10/10	D	BMM
	125	05/06 → 12/12	D	BMN, CEGA, CFJA

2.0 TDI 16V	103	07/05 → 12/12	D	BKD, CFHC, CLCB
-------------	-----	---------------	---	-----------------

**Toledo II**

1.9 TDI	96	05/03 → 05/06	D	ASZ
	110	10/00 → 07/04	D	ARL

**Toledo III**

2.0 TDI	100	09/04 → 05/09	D	AZV
	103	11/05 → 05/09	D	BMM

2.0 TDI	125	01/06 → 05/09	D	BMN, CEGA
---------	-----	---------------	---	-----------

2.0 TDI 16V	103	04/04 → 05/09	D	BKD
-------------	-----	---------------	---	-----

**SKODA**
**Octavia I, Station Wagon**

1.9 TDI	74	10/05 → 12/10	D	AXR
	96	09/02 → 09/04	D	ASZ

1.9 TDI 4x4	74	09/00 → 01/06	D	ATD
-------------	----	---------------	---	-----

**Octavia II, Station Wagon**

2.0 TDI	100	02/04 → 05/10	D	AZV
	103	11/05 → 05/10	D	BMM

2.0 TDI 16V	100	02/04 → 05/10	D	AZV
	103	02/04 → 04/13	D	BKD, CFHC, CLCB

2.0 TDI 4x4	103	07/06 → 05/10	D	BMM
-------------	-----	---------------	---	-----

2.0 TDI RS	125	04/06 → 02/13	D	BMN, CEGA
------------	-----	---------------	---	-----------

**Roomster, Van**

1.9 TDI	74	03/06 → 05/06	D	AXR
---------	----	---------------	---	-----

**Superb I**

1.9 TDI	74	08/02 → 10/05	D	AVB
	77	10/05 → 05/07	D	BSV
	85	01/07 → 03/08	D	BPZ
	96	12/01 → 03/08	D	AVF, AWX

2.0 TDI	103	10/05 → 03/08	D	BSS
---------	-----	---------------	---	-----



**81816 350981816000**

**SKODA**
**Superb II, Station Wagon**

2.0 TDI	103	03/08 → 05/10	D	BMP	
	125	07/08 → 05/15	D	CBBB, CFGB	
2.0 TDI 16V	103	01/09 → 05/15	D	BKD, CFFB, CLJA	
2.0 TDI 4x4	125	09/08 → 05/15	D	CBBB, CFGB	

**Yeti**

2.0 TDI 4x4	103	05/09 →	D	CBDB, CFHC, CLCB	M: CBDB
	125	11/09 →	D	CEGA, CFJA	M: CEGA

**VOLKSWAGEN**
**Beetle II (Maggiolino)**

2.0 TDI	103	04/12 →	D	CFFB, CJAA	
---------	-----	---------	---	------------	--

**Bora, Station Wagon**

1.9 TDI	74	09/00 → 05/05	D	ATD, AXR	
	85	12/98 → 01/02	D	AJM, AUY	
	96	11/00 → 05/05	D	ASZ	
	110	05/00 → 05/05	D	ARL	
1.9 TDI 4motion	74	09/00 → 05/05	D	ATD	
	85	02/99 → 06/01	D	AJM, AUY	
	96	11/00 → 05/05	D	ASZ	
	110	05/00 → 05/05	D	ARL	

**Caddy III**

2.0 TDI	103	09/07 → 08/10	D	BMM	
---------	-----	---------------	---	-----	--

**Eos**

2.0 TDI	103	06/06 → 05/08	D	BMM	
2.0 TDI 16V	103	05/08 →	D	CBAB, CFFB	

**Golf IV, Variant, Cabrio**

1.9 TDI	74	09/00 → 06/05	D	ATD, AXR	
	85	12/98 → 06/01	D	AJM, AUY	
	96	11/00 → 06/05	D	ASZ	
	110	06/01 → 06/06	D	ARL	
	110	05/00 → 06/05	D	ARL	M: ARL
1.9 TDI 4motion	74	09/00 → 06/05	D	ATD	
	85	05/99 → 06/01	D	AJM	
	85	09/99 → 06/01	D	AJM, AUY	
	96	11/00 → 06/05	D	ASZ	
	110	05/02 → 06/05	D	ARL	
110	02/00 → 06/05	D	ARL	M: ARL	

**81816 350981816000**

**VOLKSWAGEN**
**Golf V, Plus, Variant**

2.0 TDI	81	01/09 → 12/13	D	CBDC, CLCA	
	96	05/05 → 05/07	D	BEE	
	100	06/07 → 07/09	D	AZV	
	100	10/03 → 11/08	D	AZV, CBDA	
	100	05/05 → 12/13	D	AZV, CBDA, CFHB	
	103	12/05 → 05/11	D	BMM	
2.0 TDI 16V	125	11/05 → 11/08	D	BMN	
	103	10/03 → 11/08	D	BKD	
	103	06/07 → 07/09	D	BKD, CBDB	
	103	01/05 → 12/13	D	BKD, CBDB, CFHC	
2.0 TDI 16V 4motion	103	08/04 → 11/08	D	BKD	
2.0 TDI 4motion	100	06/07 → 07/09	D	AZV	
	103	08/04 → 11/08	D	BMM	

**Golf VI, Variant, Cabrio**

2.0 TDI	81	10/08 → 11/12	D	CBDC, CLCA	
	100	10/08 → 11/12	D	CBAA, CFFA	M: CBAA
	100	07/09 → 07/13	D	CBDA, CFHB	
	103	10/08 → 05/13	D	CBAB, CFFB, CJAA	
	125	04/09 → 11/12	D	CBBB, CFGB	
2.0 TDI 16V	103	07/09 → 07/13	D	CBDB, CFHC, CJAA, CLCB	
2.0 TDI 4motion	103	05/09 → 11/12	D	CBAB, CFFB	M: CBAB

**Jetta III**

2.0 TDI	100	09/05 → 10/10	D	AZV, CBDA	
	103	10/05 → 10/10	D	BMM	
	125	10/06 → 10/10	D	BMN, CEGA	
2.0 TDI 16V	103	08/05 → 10/10	D	BKD, CBDB, CBEA, CJAA	

**New Beetle, Cabrio**

1.9 TDI	74	06/03 → 09/10	D	AXR	
	77	07/05 → 09/10	D	BSW	

**Passat IV, Variant**

1.9 TDI	74	02/00 → 11/00	D	AVB	
	85	08/98 → 11/00	D	AJM, ATJ	
1.9 TDI 4motion	85	08/99 → 11/00	D	ATJ	

## 81816 350981816000



### VOLKSWAGEN

#### Passat V, Variant

1.9 TDI	74	11/00 → 05/05	D	AVB
	96	11/00 → 05/05	D	AVF, AWX
	96	11/00 → 05/05	D	AVF, AWX
1.9 TDI 4motion	96	11/00 → 05/05	D	AVF
	96	11/00 → 05/05	D	AVF
2.0 TDI	100	12/03 → 05/05	D	BGW, BHW

#### Passat VI, Variant, CC

2.0 BlueTDI	105	01/09 → 11/10	D	CBAC	
2.0 TDI	81	11/08 → 07/10	D	CBDC	
	88	11/05 → 05/07	D	BWV	
	90	08/05 → 07/06	D	BVE	
	100	03/05 → 11/10	D	BMA, CBAA	
	100	06/08 → 05/11	D	CBAA, CFFA	
	103	03/05 → 05/09	D	BMP	
	103	06/08 → 01/12	D	CBAB, CFFB	
	120	08/05 → 05/09	D	BUZ	
	125	08/05 → 07/10	D	BMR, CBBB	
	125	06/08 → 01/12	D	CBBB, CFGB, CLLA	
	2.0 TDI 16V	103	03/05 → 07/10	D	BKP, CBAB
	2.0 TDI 16V 4motion	103	03/05 → 08/10	D	BKP, CBAB
2.0 TDI 4motion	103	03/05 → 05/09	D	BMP	
	103	08/09 → 01/12	D	CBAB, CFFB	
	125	05/09 → 07/10	D	CBBB	
	125	11/09 → 01/12	D	CBBB, CFGB	

#### Scirocco III

2.0 TDI	103	08/08 →	D	CBDB, CFHC
	125	05/09 →	D	CBBB, CFGB

#### Sharan I

1.9 TDI	66	09/95 → 03/10	D	1Z, AHU, ANU	03-2000 →, M: ANU
	85	04/00 → 03/10	D	AUY, BVK	
1.9 TDI 4motion	85	04/00 → 03/10	D	AUY, BVK	
2.0 TDI	100	11/05 → 03/10	D	BVH	
	103	11/05 → 03/10	D	BRT	

#### Tiguan I

2.0 TDI	103	03/08 →	D	CBAB, CFFB
2.0 TDI 4motion	100	11/07 →	D	CBAA, CFFA
	103	09/07 →	D	CBAB, CFFB, CLJA
	120	02/08 → 08/09	D	CBBA
	125	09/07 →	D	CBBB, CFGB

## 81816 350981816000



### VOLKSWAGEN

#### Touran I

2.0 TDI	100	02/03 → 05/10	D	AZV
	103	12/05 → 05/10	D	BMM
	125	12/05 → 05/10	D	BMN, CFJA
2.0 TDI 16V	103	08/03 → 05/10	D	BKD

## 81817

## 350981817000



### PULEGGIA

Diametro Puleggia	Ø57.2
Numero Denti/Gole Puleggia	23
Altezza Puleggia	21
Posizione Attacco	60.5
Diametro Girante	Ø56
N° Alette Girante	8
Posizione Girante	35



### OPEL

#### Astra G, Station Wagon, Coupé, Cabrio, Van

1.4 16V	66	02/98 → 01/05	B	X14XE, Z14XE	09-2000 →, M→: 20U75999, M→: 02MV7225, M→: 20U75999
1.6 16V	74	02/98 → 01/05	B	C16SEL, X16XEL, Z16XE	M→: 02MV7225, M→: 20U75999
				X16XEL, Z16XE	M→: 02MV7225, M→: 20U75999
				Z16XE	M→: 02MV7225, M→: 20U75999
				Z16XE	
1.6 CNG	71	03/03 → 07/04		Z16YNG	
1.6 LPG	74	06/02 → 01/05		Z16XE	

#### Combo B

1.6 CNG	69	06/06 →		Z16YNG
				Z16YNG
1.6 CNG 16V	69	06/06 →		Z16YNG
				Z16YNG

#### Corsa C, Van

1.4	66	09/00 → 12/09	B	Z14XE
-----	----	---------------	---	-------

#### Meriva A

1.6 16V	74	05/03 → 01/06	B	Z16XE
---------	----	---------------	---	-------

**81817 350981817000**

**OPEL**
**Vectra B, Station Wagon**

1.6 i 16V	74	10/95 → 04/02	B	X16XEL, Y16XE, Z16XE	M →: 20U75999, M →: 02MV7225
	74	10/95 → 07/02	B	X16XEL, Y16XE, Z16XE	M →: 02MZ5254
	74	11/96 → 07/02	B	X16XEL, Y16XE, Z16XE	M →: 20U75999, M →: 02MZ5254

**Vectra C, Station Wagon**

1.6	74	08/05 →	B	Z16XE	
1.6 16V	74	06/04 →	B	Z16XE	

**Zafira A**

1.6 16V	74	04/99 → 06/05	B	X16XEL, Z16XE	07-2000 →, M →: 02MV7225, M →: 20U75999, M →: 02MV7225
1.6 CNG	71	09/01 → 06/05		Z16YNG	

**Zafira B, Van**

1.6 CNG	69	01/06 →		Z16YNG	
1.6 CNG Turbo	110	02/09 →		A16XNT, Z16XNT	

**VAUXHALL**
**ASTRA**

1.4 16V	66	02/98 → 05/05	B	X14XE, Z14XE	09-2000 →
1.6 16V	74	09/98 → 05/05	B	C16SEL, X16XEL, Z16XE, Z16XEP	09-2000 →
	74	02/98 → 05/05	B	X16XEL, Z16XE	09-2000 →
	74	03/01 → 10/05	B	Z16XE	

**CORSA**

1.4 16V	66	09/00 → 10/06	B	Z14XE	
---------	----	---------------	---	-------	--

**MERIVA**

1.6 i 16V	74	01/03 → 09/05	B	Z16XE	
-----------	----	---------------	---	-------	--

**ZAFIRA**

1.6 16V	74	04/99 → 08/05	B	X16XEL, Z16XE	07-2000 →
---------	----	---------------	---	------------------	-----------

**81818 350981818000**

**PULEGGIA**

Diametro Puleggia	Ø56.3
Numero Denti/Gole Puleggia	19
Altezza Puleggia	20
Posizione Attacco	58.2
Diametro Girante	Ø56
N° Alette Girante	8
Posizione Girante	35

**OPEL**
**Astra G, Station Wagon, Coupé, Cabrio, Van**

1.4 16V	66	09/98 → 01/05	B	X14XE, Z14XE	09-2000 →
1.6	62	09/00 → 01/05	B	Z16SE	M →: 02MZ5254, M →: 20U75999
	62	09/00 → 07/04	B	Z16SE	M →: 20U75999, M →: 02MZ5254
	76	12/02 → 12/09	B	Z16XEP	
1.6 16V	74	09/98 → 01/05	B	X16XEL, Z16XE	09-2000 →

**Combo B**

1.6	64	10/01 →	B	Z16SE	M: Z16SE
	64	10/01 →	B	Z16SE	

**Meriva A**

1.6	64	05/03 → 05/10	B	Z16SE	
-----	----	---------------	---	-------	--

**Vectra B, Station Wagon**

1.6 i	55	10/95 → 04/02	B	X16SZR	01-2000 →, M →: 02MZ5254
	55	10/95 → 07/03	B	X16SZR	M →: 02MZ5254

**VAUXHALL**
**ASTRA**

1.6	62	09/00 → 05/05	B	Z16SE	
-----	----	---------------	---	-------	--

**MERIVA**

1.6 i	64	01/03 → 06/10	B	Z16SE	
-------	----	---------------	---	-------	--

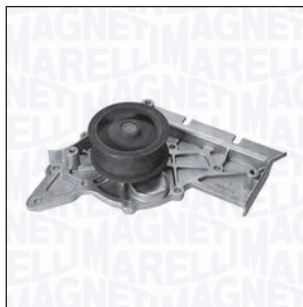
**81819**
**350981819000**

**PULEGGIA**

Diametro Puleggia	Ø74
Altezza Puleggia	31.5
Posizione Attacco	60
Diametro Girante	Ø79
N° Alette Girante	5
Posizione Girante	28.8

**KW**

**AUDI**
**A4 II, Avant, Cabriolet**

3.0	160	04/01 → 12/04	B	BBJ	
	162	09/01 → 12/04	B	ASN	
	162	11/00 → 12/04	B	ASN, AVK	
3.0 quattro	160	04/01 → 12/04	B	BBJ	
	162	05/03 → 12/05	B	ASN	
	162	09/01 → 12/04	B	ASN, AVK	
	162	11/00 → 12/04	B	ASN, AVK	

**A4 III, Avant**

3.0	160	11/04 → 05/06	B	BBJ	
3.0 quattro	160	11/04 → 07/06	B	BBJ	

**A6 II, Avant**

3.0	162	08/01 → 01/05	B	ASN	
3.0 quattro	160	06/01 → 07/04	B	BBJ	
	162	08/01 → 01/05	B	ASN	

**A6 III, Avant, Allroad**

3.0	160	08/04 → 05/06	B	BBJ	
3.0 quattro	160	05/04 → 05/06	B	BBJ	

**A8 II**

3.0	160	07/03 → 05/06	B	BBJ	
	162	07/03 → 05/05	B	ASN	
3.0 quattro	160	11/03 → 05/04	B	BBJ	

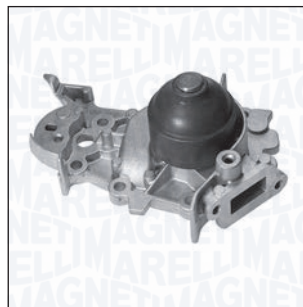
**81820**
**350981820000**

**PULEGGIA**

Diametro Puleggia	Ø56.2
Altezza Puleggia	27
Posizione Attacco	53.4
Diametro Girante	Ø60
N° Alette Girante	6
Posizione Girante	5.5

**KW**

**DACIA**
**Sandero I**

1.2 16V	55	11/08 →	B	D4F732	
---------	----	---------	---	--------	--

**NISSAN**
**Kubistar**

1.2 16V	55	04/06 → 10/09	B	D4F712	
---------	----	---------------	---	--------	--

**RENAULT**
**Clio II**

1.2 16V	55	06/01 →	B	D4F706, D4F712, D4F714, D4F722, D4F728	→ 05-2003
---------	----	---------	---	--	-----------

**Clio III, Grandtour**

1.2 16V	76	09/10 →	B	D4F786	
1.2 Ethanol	55	07/08 →			

**Clio IV, Grandtour**

1.2 16V	54	11/12 →	B	D4F728, D4F740	
	54	01/13 →	B	D4F740	

**Kangoo I, Van**

1.2 16V	55	06/01 →	B	D4F712, D4F714, D4F716, D4F730	
	55	10/01 →	B	D4F712, D4F714, D4F730	

**Modus**

1.2	48	05/05 →	B	D4F740	
	55	12/04 →	B	D4F740	
	58	12/04 →	B	D4F764	
1.2 16V	74	05/07 →	B	D4F784	
1.2 16V Hi-Flex	55	10/08 →		D4F740	

**Thalia I**

1.2 16V	55	04/02 →	B	D4F706, D4F712	
---------	----	---------	---	-------------------	--

**81820 350981820000**

**RENAULT**
**Twingo I**

1.2 16V	44	08/04 → 06/07	B	D4F708
	55	01/01 →	B	D4F702

**81821 350981821000**

**FLANGIA**

Numero Fori Flangia	4
Dimensione Fori Flangia	M6×1
Posizione Attacco	58.2
Diametro Mozzo	Ø35.8
Diametro Girante	Ø56.5
N° Alette Girante	6
Posizione Girante	21.2

**MINI**
**Mini I (R50,R52, R53)**

One D	55	06/03 → 09/06	D	1ND
	65	06/03 → 09/06	D	1ND-TV

**TOYOTA**
**Auris I, Van**

1.4 D-4D	66	03/07 → 09/12	D	1ND-TV	→ 01-2009
----------	----	---------------	---	--------	-----------

**Corolla Verso**

1.4 D-4D	66	03/04 → 03/09	D	1ND-TV	→ 01-2009
----------	----	---------------	---	--------	-----------

**Corolla VIII, Hatchback, Station Wagon**

1.4 D-4D	66	01/07 →	D	1ND-TV	→ 01-2009
----------	----	---------	---	--------	-----------

**Yaris II**

1.4 D-4D	66	08/05 →	D	1ND-TV
----------	----	---------	---	--------

**VOLKSWAGEN**
**Passat VII, Variant, CC, AllTrack**

1.4 TSI	90	08/10 → 12/14	B	CAXA	→ 01-2009
---------	----	---------------	---	------	-----------

**81822 350981822000**

**PULEGGIA**

Diametro Puleggia	Ø150
Numero Denti/Gole Puleggia	3
Posizione Attacco	76
Diametro Girante	Ø80
N° Alette Girante	10
Posizione Girante	-1

**CITROËN**
**C 25**

1.9 D	51	07/87 → 02/94	D	D9B (XUD9A/U)	(-)AC
1.9 D 1400	51	01/88 → 01/94	D	DJY (XUD9A)	(-)AC
1.9 TD	60	04/92 → 02/94	D	M705	(-)AC
2.5 D	54	10/85 → 02/94	D	CRD93L (U25-661)	(-)AC
2.5 D 4x4	54	01/87 → 02/94	D	CRD93L (U25-661)	(-)AC
2.5 D Turbo	70	08/87 → 02/94	D	CRD93LS (U25-673)	(-)AC
2.5 D Turbo 4x4	70	08/87 → 02/94	D	CRD93LS (U25-673)	(-)AC
2.5 DT	70	01/87 → 01/94	D	CRD93LS (U25-673)	(-)AC

**CX II, Break**

25 D	54	08/85 → 12/92	D	M25-660	
25 D Turbo	88	01/87 → 12/92	D	M25-669	
25 D Turbo 2	88	01/87 → 12/92	D	M25-669	
25 GTi	89	05/86 → 12/92	B	M25-668	(-)AC
25 GTi	115	09/86 → 12/92	B	M25-667	(-)AC
Turbo 2	122	08/85 → 12/92	B	M25-662	(-)AC
25 i	89	05/86 → 12/92	B	M25-668	(-)AC
25 TRi	100	08/85 → 12/92	B	M25-659	(-)AC

**FIAT**
**Ducato I**

2.5 D	55	01/82 → 08/90	D	8144.67, CRD93L (U25-661)
-------	----	---------------	---	---------------------------

**PEUGEOT**
**J5 I**

2.5 D	54	09/81 → 08/90	D	CRD93
	54	09/81 → 09/90	D	CRD93 (U25/661)
2.5 DT	70	09/81 → 08/90	D	CRD93L, CRD93LS (U25/673)

## 81822 350981822000



### PEUGEOT

#### J5 II

2.5 D	54	09/90 → 01/94	D	CRD93	
	54	10/90 → 02/94	D	CRD93 (U25/661)	
2.5 D 4x4	54	10/90 → 02/94	D	CRD93 (U25/661)	
2.5 DT	70	09/90 → 01/94	D	CRD93L	
2.5 TD	70	10/90 → 02/94	D	CRD93LS (U25/673)	
2.5 TD 4x4	70	10/90 → 02/94	D	CRD93LS (U25/673)	

## 81828 350981828000

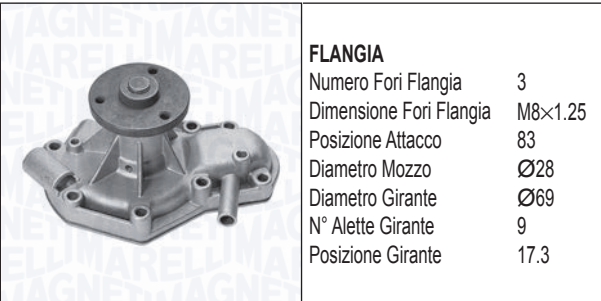

**FLANGIA**  
 Numero Fori Flangia 3  
 Dimensione Fori Flangia M8x1.25  
 Posizione Attacco 83  
 Diametro Mozzo Ø28  
 Diametro Girante Ø69  
 N° Alette Girante 9  
 Posizione Girante 17.3



### RENAULT

#### 25

2.0	74	04/84 → 12/92	B	J6R706, J6R707, J6R760, J6R762, J6R763	→ M: F.308.131
-----	----	---------------	---	--	----------------

#### Master I

28-35 2.0	58	10/86 → 07/98	B	J5R718	→ M: F029.328
	58	10/86 → 07/98	B	J5R728	→ M: F029.328

30 2.2	67	08/80 → 07/98	B	J7T782, J7T788	→ M: F305.272
--------	----	---------------	---	----------------	---------------

#### Trafic I

2.0	59	05/89 → 08/90	B	J5R716	01-1981 →, → M: F029.328
	59	05/89 → 08/90	B	J5R726	01-1981 →, → 08-1994
2.2	70	05/89 → 06/94	B	J7T780	01-1981 →
	74	06/94 → 10/97	B	J7T600	01-1981 →, → M: F305.272

## 81832 350981832000



**FLANGIA**  
 Numero Fori Flangia 3  
 Dimensione Fori Flangia M8x1.25  
 Posizione Attacco 94.5  
 Diametro Mozzo Ø40  
 Diametro Girante Ø68  
 N° Alette Girante 8  
 Posizione Girante -0.5



### VOLKSWAGEN

#### Transporter III

2.1	64	10/86 → 07/92	B	SR	
	70	08/85 → 07/92	B	MV	
	82	08/84 → 07/92	B	DJ	
2.1 Cat.	70	06/89 → 07/92	B	MV	
2.1 i	68	07/89 → 07/92	B	SS	
2.1 Syncro	64	10/86 → 07/92	B	SR	
	70	08/85 → 07/92	B	MV	
	82	01/86 → 07/92	B	DJ	

## 81833 350981833000



**PULEGGIA**  
 Diametro Puleggia Ø59.3  
 Numero Denti/Gole Puleggia 20  
 Altezza Puleggia 21  
 Posizione Attacco 32.5  
 Diametro Girante Ø72  
 N° Alette Girante 7  
 Posizione Girante 33



### VOLKSWAGEN

#### LT I 28-35, 40-55

2.4	66	12/82 → 07/92	B	DL	
2.4 4WD	66	12/82 → 07/92	B	DL	
2.4 i	69	08/89 → 06/96	B	1E	

**81834**
**350981834000**

**KW**

**OPEL**
**Movano A**

2.5 D	59	07/98 → 09/00	D	S8U770, S8U772	
2.8 DTI	84	01/99 → 10/01	D	S9W700, S9W702	→ 12-1999

**RENAULT**
**Master II**

2.5 D	59	07/98 → 01/01	D	S8U770	
2.8 dTI	84	07/98 → 10/01	D	S9W702	→ 12-1999

**VAUXHALL**
**Movano**

2.5 D	59	10/98 → 01/01	D	S8U770	
-------	----	---------------	---	--------	--

**81835**
**350981835000**

**KW**

**OPEL**
**Movano A**

2.8 DTI	84	07/98 → 10/01	D	S9W700, S9W702	
	84	01/99 → 10/01	D	S9W700, S9W702	01-2000→

**RENAULT**
**Master II**

2.8 dTI	84	07/98 → 10/01	D	S9W702	01-2000→
---------	----	---------------	---	--------	----------

**VAUXHALL**
**Movano**

2.8 DTI	84	10/98 → 10/01	D	S9W702	
	84	10/98 → 10/01	D	S9W702	

**81836**
**350981836000**

**KW**

**OPEL**
**Astra G, Station Wagon, Coupé, Cabrio, Van**

1.7 CDTI	59	04/03 → 12/09	D	Z17DTL	
1.7 DTI 16V	55	02/00 → 01/05	D	Y17DT	09-2000 →, M →: 073533
	55	02/00 → 01/05	D	Y17DT	

**Astra H, Station Wagon, GTC, Twin Top, Van**

1.7 CDTI	59	03/04 →	D	Z17DTL	
	74	03/04 →	D	Z17DTH	→ T: 1874032
	74	03/04 →	D	Z17DTH	
	81	02/07 →	D	A17DTJ	
	81	02/07 →	D	A17DTJ, Z17DTJ	
	81	02/07 →	D	Z17DTJ	
	92	02/07 →	D	A17DTR	
	92	02/07 →	D	A17DTR, Z17DTR	

**Combo B**

1.4	66	10/04 →	B	Z14XEP	
1.7 CDTI 16V	74	12/04 →	D	Z17DTH	
1.7 DI 16V	48	10/01 →	D	Y17DTL	
1.7 DTI 16V	55	10/01 →	D	Y17DT	

**Corsa C, Van**

1.7 CDTI	74	06/03 → 12/09	D	Z17DTH	
1.7 DI	48	09/00 → 12/09	D	Y17DTL	
1.7 DI 16V	48	09/00 →	D	Y17DTL	
1.7 DTI	55	09/00 → 12/09	D	Y17DT	
1.7 DTI 16V	55	09/00 →	D	Y17DT	

**Corsa D, Van**

1.7 CDTI	92	07/06 →	D	Z17DTR	→ T: 1874032
	96	06/10 →	D	A17DTS	→ T: 1874032

**Meriva A**

1.7 CDTI	74	09/03 → 05/10	D	Z17DT, Z17DTH	
	92	09/06 → 05/10	D	A17DTR, Z17DTR	
1.7 DTI	55	09/03 → 05/10	D	Y17DT	

**81836** **350981836000**



**OPEL**

**Zafira B, Van**

1.7 CDTI	81	01/08 →	D	A17DTJ, Z17DTJ	→ T: 1874032
	81	01/08 →	D	A17DTJ, Z17DTJ	
	92	01/08 →	D	A17DTR	→ T: 1874032
	92	01/08 →	D	A17DTR	

**VAUXHALL**

**Combo**

1.7 DI 16V	48	09/01 → 11/11	D	Y17DTL	
------------	----	---------------	---	--------	--

**81837** **350981837000**

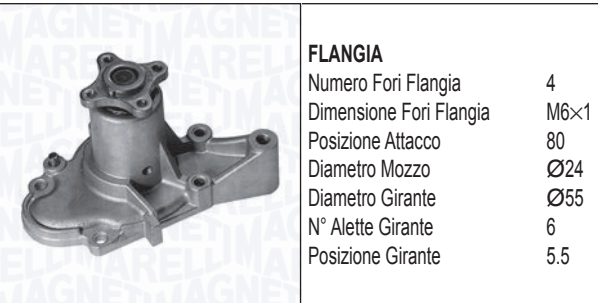

<b>FLANGIA</b>	
Numero Fori Flangia	4
Dimensione Fori Flangia	M6×1
Posizione Attacco	80
Diametro Mozzo	Ø24
Diametro Girante	Ø55
N° Alette Girante	6
Posizione Girante	5.5



**HYUNDAI**

**Atos, Atos Prime**

0.8	38	04/99 → 07/03	B	G3HJ	
1.0 i	40	02/98 → 03/02	B	G4HC	
	43	03/01 →	B	G4HC-E	
1.1	43	08/03 → 05/05	B	G4HD	

**81838** **350981838000**

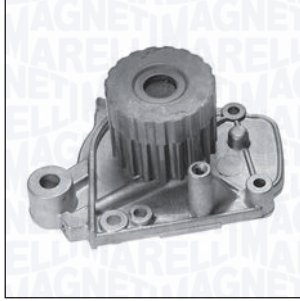

<b>PULEGGIA</b>	
Diametro Puleggia	Ø56
Numero Denti/Gole Puleggia	19
Altezza Puleggia	44.5
Posizione Attacco	61
Diametro Girante	Ø61
N° Alette Girante	7
Posizione Girante	14



**HONDA**

**Accord VI, Aerodeck, Hatchback, Coupé**

1.6	85	12/99 → 12/02	B	D16B6	
	65	10/98 → 12/02	B	A16A5	
1.6 i	85	10/98 → 12/02	B	D16B6	
1.6 LS	79	10/98 → 12/02	B	D16B7	

**Civic VI, Hatchback, Aerodeck, Fastback, Coupé**

1.4 16V	55	04/98 → 02/01	B	D14A7	M: SOHC
	66	04/98 → 02/01	B	D14A8	M: SOHC
1.4 i	55	11/95 → 02/01	B	D14A3, D14Z1	
1.5 16V	84	04/98 → 02/01	B	D15Z8	
1.5 i	84	11/95 → 02/01	B	D15Z6	
1.6	92	11/98 → 10/00	B	D16W4	
1.6 16V	85	04/98 → 02/01	B	D16B2	
1.6 i	77	03/96 → 03/00	B	D16Y7	M: SOHC
	84	11/95 → 02/01	B	D16Y5	
1.6 i Vtec	92	11/95 → 02/01	B	D16Y6, D16Y8	
	92	03/96 → 03/00	B	D16Y8	

**Civic VII, Hatchback, Coupé**

1.4 i	55	02/01 → 09/05	B	D14Z6	
-------	----	---------------	---	-------	--

**HR-V**

1.6 16V	77	03/99 →	B	D16W1	
1.6 16V	77	03/99 →	B	D16W1	
4WD	91	10/99 →	B	D16W5	



**81839**
**350981839000**

**PULEGGIA**

Diametro Puleggia	Ø65
Numero Denti/Gole Puleggia	22
Altezza Puleggia	30
Posizione Attacco	47
Diametro Girante	Ø55
N° Alette Girante	7
Posizione Girante	18

**KW**

**ACURA**
**Integra III**

1.8 LS	125	10/93 → 09/01	B	F18C1
--------	-----	---------------	---	-------

**HONDA**
**Civic V, Hatchback, Coupé**

1.6 i Vtec	118	01/94 → 11/95	B	B16A2
------------	-----	---------------	---	-------

1.6 VTi	118	10/91 → 11/95	B	B16A2
---------	-----	---------------	---	-------

1.6 VTi 16V	118	10/91 → 11/95	B	B16A2
-------------	-----	---------------	---	-------

**Civic VI, Hatchback, Aerodeck, Fastback, Coupé**

1.6 i Vtec	118	04/99 → 12/00	B	B16A2
------------	-----	---------------	---	-------

1.6 VTi	118	01/97 → 02/01	B	B16A2
	118	11/95 → 02/01	B	B16A2

1.8 16V	124	04/98 → 02/01	B	B18C4
---------	-----	---------------	---	-------

**Integra II**

1.8 Type-R	140	11/97 → 10/01	B	B18C6
------------	-----	---------------	---	-------

**81840**
**350981840000**

**PULEGGIA**

Diametro Puleggia	Ø67.3
Numero Denti/Gole Puleggia	27
Altezza Puleggia	21
Posizione Attacco	56
Diametro Girante	Ø63.6
N° Alette Girante	8
Posizione Girante	35.1

**KW**

**AUDI**
**A2**

1.6 FSI	81	05/02 → 08/05	B	BAD
---------	----	---------------	---	-----

**SEAT**
**Leon I**

1.6 16 V	77	09/00 → 06/06	B	ATN, AUS, AZD, BCB
----------	----	---------------	---	-----------------------

**Toledo II**

1.6 16V	77	06/00 → 05/06	B	AUS, AZD, BCB
---------	----	---------------	---	------------------

**81840**
**350981840000**

**KW**

**VOLKSWAGEN**
**Bora, Station Wagon**

1.6 16V	77	05/00 → 05/05	B	ATN, AUS, AZD, BCB
---------	----	---------------	---	-----------------------

1.6 FSI	81	01/02 → 05/05	B	BAD
---------	----	---------------	---	-----

**Golf IV, Variant, Cabrio**

1.6	78	08/03 → 06/05	B	AWB
-----	----	---------------	---	-----

1.6 16V	77	02/00 → 06/05	B	ATN, AUS, AZD, BCB
---------	----	---------------	---	-----------------------

1.6 FSI	81	01/02 → 06/05	B	BAD → 09-2003
---------	----	---------------	---	---------------

**Lupo I**

1.6 GTI	92	09/00 → 07/05	B	AVY
---------	----	---------------	---	-----

**Polo III (6N1), Classic, Variant, Van**

120 1.6 16V GTI	88	09/98 → 10/99	B	AJV
--------------------	----	---------------	---	-----

**Polo IV (6N2)**

1.6 16V GTI	92	10/99 → 09/01	B	ARC, AVY
-------------	----	---------------	---	----------

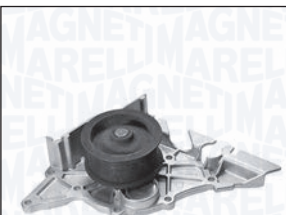
**81842**
**350981842000**

**PULEGGIA**

Diametro Puleggia	Ø74
Altezza Puleggia	31.5
Posizione Attacco	60.2
Diametro Girante	Ø79
N° Alette Girante	5
Posizione Girante	29.4

**KW**

**AUDI**
**A4 I, Avant**

2.4	110	07/95 → 07/97	B	AFM
-----	-----	---------------	---	-----

2.4	120	08/97 → 11/00	B	AJG, AMM, APZ
-----	-----	---------------	---	------------------

2.4	121	03/97 → 11/00	B	AGA, ALF, AML, APS, ARJ
-----	-----	---------------	---	-------------------------------

2.4 quattro	120	08/97 → 11/00	B	APZ
-------------	-----	---------------	---	-----

2.4 quattro	121	03/97 → 11/00	B	AGA, ALF, AML, APS, ARJ
-------------	-----	---------------	---	-------------------------------

2.6	102	01/96 → 07/97	B	ACZ
-----	-----	---------------	---	-----

2.6	110	01/95 → 11/00	B	ABC
-----	-----	---------------	---	-----

2.6 quattro	110	01/95 → 11/00	B	ABC
-------------	-----	---------------	---	-----

2.7 Turbo quattro	169	02/99 → 09/00	B	AJK
----------------------	-----	---------------	---	-----

**81842**
**350981842000**

**AUDI**
**A4 I, Avant**

2.8	128	09/95 → 07/97	B	AAH	
	142	10/96 → 11/00	B	ACK, AHA, ALG, AMX, APR, AQD	
2.8 quattro	128	01/95 → 07/97	B	AAH	
	142	10/96 → 08/01	B	ACK, AHA, ALG, AMX, APR, AQD	
RS4 quattro	280	05/00 → 09/01	B	ASJ, AZR	
S4 quattro	195	09/97 → 09/01	B	AGB, AZB	01-1999→
	195	09/97 → 09/01	B	AGB, AZB	

**A4 II, Avant, Cabriolet**

2.4	120	09/01 → 12/04	B	AMM	
	125	09/01 → 12/04	B	BDV	

**A6 I, Avant**

2.4	110	07/95 → 06/96	B	AFM	
2.6	102	06/94 → 10/97	B	ACZ	08-1996 →, →02-1997, T→: F44-S-026-715
	110	06/94 → 10/97	B	ABC	08-1996 →, →02-1997, T→: F44-S-026-715
	110	06/94 → 12/97	B	ABC	08-1996 →, →12-1997, T→: F44-S-026.715
2.6 quattro	110	06/94 → 10/97	B	ABC	08-1996 →, →02-1997, T→: F44-S-026-715
	110	06/94 → 12/97	B	ABC	08-1996 →, →12-1997, T→: F44-S-026.715
2.8	128	06/94 → 12/97	B	AAH, AEJ	08-1996 →, →12-1997, T→: F44-S-026.715
	128	06/94 → 10/97	B	AAH, AEJ, AFC	08-1996 →, →02-1997, T→: F44-S-026.715
	142	12/95 → 10/97	B	ACK	T→: F44-S-026.715

**81842**
**350981842000**

**AUDI**
**A6 I, Avant**

2.8 quattro	128	06/94 → 10/97	B	AAH, AEJ	08-1996 →, →02-1997, T→: F44-S-026.715
	128	06/94 → 12/97	B	AAH, AEJ	08-1996 →, →12-1997, T→: F44-S-026.715
2.8 quattro	142	12/95 → 10/97	B	ACK	
	142	12/95 → 12/97	B	ACK	T→: F44-S-026.715

**A6 II, Avant**

2.4	100	07/98 → 01/05	B	ALW, ARN, ASM	
	115	02/97 → 01/05	B	APC	
	120	02/97 → 01/05	B	AJG, AMM, APZ	
	121	02/97 → 01/05	B	AGA, ALF, AML, APS, ARJ	
2.4	121	12/97 → 01/05	B	AGA, ALF, AML, APS, ARJ	T→: F44-S-026.715
	125	08/01 → 01/05	B	BDV	
	115	08/98 → 07/99	B	APC	
2.4 quattro	120	02/97 → 01/05	B	AJG, APZ	
	121	02/97 → 01/05	B	AGA, ALF, AML, APS, ARJ	
	121	12/97 → 01/05	B	AGA, ALF, AML, APS, ARJ	T→: F44-S-026.715
	125	08/01 → 01/05	B	BDV	
	2.7	187	05/01 → 07/04	B	APB, BEL
2.7 quattro	187	05/01 → 07/04	B	APB, BEL	
	195	11/03 → 07/04	B	BEL	
2.7 T	169	02/99 → 01/05	B	AJK	T→: F44-S-026.715
	169	02/99 → 01/05	B	AJK	
2.7 T quattro	169	12/97 → 01/05	B	AJK, AZA	01-1999→
	169	12/97 → 01/05	B	AJK, AZA	T→: F44-S-026.715
	169	12/97 → 01/05	B	AJK, AZA	
	184	08/01 → 01/05	B	ARE, BES	

**81842**
**350981842000**

**AUDI**
**A6 II, Avant**

2.8	132	10/97 → 05/00	B	AGE	
	140	07/99 → 01/05	B	ATX	
	140	07/99 → 01/05	B	ATX, BBG	

2.8	142	02/97 → 01/05	B	ACK, AHA, ALG, AMX, APR, AQD	T →: F44-S-026.715
	142	02/97 → 01/05	B	ACK, AHA, ALG, AMX, APR, AQD	

2.8 quattro	132	01/98 → 04/00	B	AGE	
	140	07/99 → 05/01	B	ATX	

2.8 quattro	142	02/97 → 01/05	B	ACK, AHA, ALG, AMX, APR, AQD	T →: F44-S-026.715
	142	02/97 → 01/05	B	ACK, AHA, ALG, AMX, APR, AQD	

A8 I	142	04/96 → 09/02	B	ACK, ALG, AMX, APR, AQD	T →: F4D-S-000.497
	142	04/96 → 09/02	B	ACK, AMX, APR, AQD	T →: F4D-S-000.497

Allroad	187	09/00 → 08/05	B	APB, BEL	
	184	05/00 → 08/05	B	ARE, BES	

SKODA Superb I	140	06/02 → 03/08	B	BBG	
	142	12/01 → 03/08	B	AMX	

VOLKSWAGEN Passat IV, Variant	132	05/97 → 09/99	B	AGE	
	132	05/97 → 09/99	B	AGE	
	140	09/99 → 11/00	B	ATX, BBG	

2.8 V6	142	08/96 → 11/00	B	ACK, AHA, APR, AQD	
	142	10/96 → 11/00	B	ACK, AHA, ALG, APR, AQD	

2.8 V6 Syncro/4motion	142	11/00 → 05/05	B	AMX, ATQ	
	142	11/00 → 05/05	B	AMX, ATQ	

Passat V, Variant	142	11/00 → 05/05	B	AMX, ATQ	
	142	11/00 → 05/05	B	AMX, ATQ	

**81843**
**350981843000**

	<b>PULEGGIA</b>		
	Diametro Puleggia	Ø53.25	
	Numero Denti/Gole Puleggia	18	
	Altezza Puleggia	31.5	
	Posizione Attacco	64	
	Diametro Girante	Ø70	
	N° Alette Girante	6	
Posizione Girante	18.5		

**ROVER 400 I, Station Wagon**

420 GTI/GSI/Vitesse	103	02/92 → 04/95	B	20M4F	→ 09-1992
---------------------	-----	---------------	---	-------	-----------

**800**

2.0 E	84	10/88 → 10/91	B		→ T: 200.604
2.0 Turbo	120	10/88 → 10/91	B		→ T: 200.604
820	74	10/88 → 10/91	B		→ T: 200.604
820 i/Si	103	10/88 → 12/91	B	20HD	→ T: 200.604
820 SE/SI	88	10/86 → 12/91	B	20HS	→ T: 200.604
820 SI	98	10/88 → 12/91	B	20HDM16	→ T: 200.604
820e	88	10/86 → 10/91	B	20HS	→ T: 200.604

**81844**
**350981844000**

	<b>PULEGGIA</b>		
	Diametro Puleggia	Ø69.7	
	Numero Denti/Gole Puleggia	28	
	Altezza Puleggia	36.1	
	Posizione Attacco	54.2	
	Diametro Girante	Ø69	
	N° Alette Girante	8	
Posizione Girante	57.8		

**CITROËN Xantia I, Break**

3.0 i 24V	140	01/97 → 01/98	B	XFZ (ES9J4)	→ T: 08441
-----------	-----	---------------	---	-------------	------------

**Xantia II, Break**

3.0 V6	140	01/98 → 04/03	B	XFZ (ES9J4)	→ T: 08441
--------	-----	---------------	---	-------------	------------

**XM II, Break**

3.0 V6	140	04/97 → 10/00	B	XFZ (ES9J4)	→ T: 08441
--------	-----	---------------	---	-------------	------------

**PEUGEOT 407, Station Wagon, Coupé**

3.0 24V	140	10/96 → 05/04	B	XFZ (ES9J4)	→ 12-1999, → T: 08441, → PROD: 8554
---------	-----	---------------	---	-------------	---

3.0 V6 24V	140	03/97 → 12/04	B	XFZ (ES9J4)	→ T: 08441
------------	-----	---------------	---	-------------	------------

**81844** **350981844000****RENAULT****Espace III**

3.0 V6 24V 140 10/98 → 10/02 B L7X727 → T: 08441

**Laguna I, Grantour**3.0 24V 140 03/97 → 03/01 B L7X700,  
L7X701 → T: 08441**Safrane II**

2.9 24V 140 03/99 → 12/00 B L7X713 → T: 08441

3.0 V6 123 07/96 → 12/00 B Z7X722,  
Z7X723,  
Z7X755**Thalia I**

3.0 V6 169 04/00 → 09/01 B L7X732

Turbo Sport 187 06/02 → B L7X762

**81845** **350981845000****PULEGGIA**

Diametro Puleggia Ø54.55  
 Numero Denti/Gole Puleggia 3  
 Posizione Attacco 33.3  
 Diametro Girante Ø78.5  
 N° Alette Girante 6  
 Posizione Girante 32.2

**FORD****Cougar**

2.5 ST 200 151 01/00 → 12/01 B SGA

2.5 V6 24V 125 06/00 → 12/01 B LCBB, LCBC,  
LCBE

125 08/98 → 12/01 B LCBA

**Maverick II**

3.0 V6 24V 145 02/01 → B AJ → 03-2004

**Mondeo I, Station Wagon**

2.5 i 24V 125 07/94 → 08/96 B SEA

**Mondeo II, Station Wagon**2.5 24V 125 06/00 → 09/00 B LCBD, SEB,  
SEC

125 06/00 → 09/00 B SEB, SEC

125 08/96 → 09/00 B SEA

2.5 ST 200 151 05/99 → 09/00 B SGA

**81845** **350981845000****JAGUAR****X Type, Estate**

2.0 V6 115 03/02 → 10/05 B

2.5 144 02/04 → 12/09 B

2.5 V6  
Trazione  
integrale 144 06/01 → 11/09 B

3.0 169 02/04 → 12/09 B AJ-V6

3.0 V6  
Trazione  
integrale 169 06/01 → 11/07 B AJ-V6**81846** **350981846000****FLANGIA**

Numero Fori Flangia 3  
 Dimensione Fori Flangia M6x1  
 Posizione Attacco 72.5  
 Diametro Mozzo Ø36  
 Diametro Centraggio Ø39  
 Diametro Girante Ø55  
 N° Alette Girante 6  
 Posizione Girante 29.8

**OPEL****Calibra**2.5 i V6 125 04/93 → 07/97 B C25XE,  
X25XE**Omega B, Station Wagon**

2.5 V6 125 03/94 → 09/00 B X25XE

2.6 V6 132 09/00 → 07/03 B Y26SE

3.0 V6 155 04/94 → 02/01 B X30XE

3.2 V6 160 02/01 → 07/03 B Y32SE

**Signum**

3.2 V6 155 05/03 → B Z32SE

**Sintra**

3.0 i 24V 148 11/96 → 04/99 B X30XE

**Vectra A**

2.5 V6 125 02/93 → 11/95 B C25XE

**Vectra B, Station Wagon**

2.5 144 10/99 → 06/00 B X25XE

2.5 i V6 125 10/95 → 09/00 B X25XE

2.6 i V6 125 09/00 → 04/02 B Y26SE

i 500 2.5 143 05/98 → 09/00 B X25XE

**Vectra C, Station Wagon**

3.2 V6 155 08/02 → B Z32SE

**81846** 350981846000

**RENAULT**
**Safrane II**

2.5 20V	121	07/96 → 12/00	B	N7U700, N7U701
---------	-----	---------------	---	-------------------

**SAAB**
**9-5 I, Station Wagon**

3.0 V6t	147	01/98 → 12/09	B	B308E
---------	-----	---------------	---	-------

**900 II, Cabrio, Coupé**

2.5 -24 V6	125	07/93 → 02/98	B	B258I
------------	-----	---------------	---	-------

**9000**

3.0 -24 V6	155	07/94 → 12/98	B	B308I
CD/CDE	155	07/94 → 12/98	B	B308I

**81852** 350981852000

**PULEGGIA**

Diametro Puleggia	Ø142
Numero Denti/Gole Puleggia	4
Altezza Puleggia	20
Posizione Attacco	80
Diametro Girante	Ø67
N° Alette Girante	8
Posizione Girante	18

**RENAULT**
**Twingo I**

1.2	40	03/93 → 10/96	B	C3G700, C3G702	(+)COP, (+)AC
-----	----	---------------	---	-------------------	---------------

**81847** 350981847000

**FLANGIA**

Numero Fori Flangia	4
Dimensione Fori Flangia	M6×1
Posizione Attacco	74.9
Diametro Girante	Ø70
N° Alette Girante	7
Posizione Girante	4.3

**OPEL**
**Corssa B, Station Wagon, Van**

1.7 D	44	01/99 →	D	X17D (4EE1)
-------	----	---------	---	-------------

**Vectra B, Station Wagon**

1.7 TD	60	11/96 → 12/97	D	X17DT (TC4EE1)
--------	----	---------------	---	-------------------

**81853** 350981853000

**PULEGGIA**

Diametro Puleggia	Ø147.2
Numero Denti/Gole Puleggia	6
Posizione Attacco	40.4
Diametro Girante	Ø67
N° Alette Girante	8
Posizione Girante	18

**RENAULT**
**Rapid**

1.0	27	02/86 → 05/92	B	C1C706	(+)COP, (+)AC
1.1	33	07/85 → 04/95	B	C1E750, C1E752, C1E754, C1E756, C1E760, C1E762, C1E792	(+)COP, (+)AC
1.2	40	09/91 → 03/98	B	C3G710, C3G712	(+)COP, (+)AC
1.4	43	07/85 → 03/98	B	C1J768, C1J780, C3J700, C3J702, C3J760, C3J762	(+)COP, (+)AC
	44	03/86 → 08/91	B	C2J784	(+)COP, (+)AC

**81851** 350981851000

**FLANGIA**

Numero Fori Flangia	4
Dimensione Fori Flangia	M8×1.25
Posizione Attacco	90.7
Diametro Mozzo	Ø23.9
Diametro Girante	Ø69
N° Alette Girante	9
Posizione Girante	17.3

**RENAULT**
**25**

2.1 Diesel	51	06/89 → 12/92	D	J8S736
------------	----	---------------	---	--------

**81853**
**350981853000**

**KW**

**RENAULT**
**Super 5**

1.1	33	01/86 → 03/95	B	C1E750, C1E752, C1E756, C1E760	(+)COP, (+)AC
	34	10/84 → 12/96	B	C1E750, C1E752, C1E754	(+)COP, (+)AC
1.2	40	01/87 → 08/90	B	C1G702, C1G720, C1G722	(+)COP, (+)AC
	44	01/87 → 12/96	B	C1G702	(+)COP, (+)AC
1.4	43	10/84 → 12/96	B	C1J768, C1J780, C3J700, C3J702, C3J760	(+)COP, (+)AC
	44	06/87 → 08/90	B	C2J784	(+)COP, (+)AC
1.4 Turbo	88	04/85 → 08/90	B	C1J782, C1J784, C1J788	(+)COP, (+)AC
1.4 Turbo GT	118	01/85 → 05/91	B	840730	(+)COP, (+)AC

**81854**
**350981854000**

**PULEGGIA**

Diametro Puleggia	Ø144
Numero Denti/Gole Puleggia	1
Posizione Attacco	29.5
Diametro Girante	Ø67
N° Alette Girante	8
Posizione Girante	18

**KW**

**RENAULT**
**Clio I**

1.2	40	06/94 → 02/98	B	C3G720	(+)COP
	40	01/96 → 12/96	B	C3G720	(+)COP
<b>Rapid</b>					
1.2	40	09/91 → 03/98	B	C3G710, C3G712	(+)COP, 05-1995→
<b>Twingo I</b>					
1.2	40	03/93 → 10/96	B	C3G700, C3G702	(+)COP, (-)AC

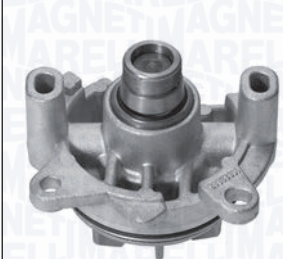
**81855**
**350981855000**

**FLANGIA**

Posizione Attacco	43.15
Diametro Mozzo	M22×1
Diametro Girante	Ø70
N° Alette Girante	8
Posizione Girante	45

**KW**

**NISSAN**
**Interstar**

dCi 90	66	07/02 →	D	G9T722
--------	----	---------	---	--------

**Primastar**

dCi 140	99	07/03 →	D	G9U730
---------	----	---------	---	--------

**OPEL**
**Movano A**

2.2 DTI	66	09/00 →	D	G9T720, G9T722, G9T750
	74	09/07 →	D	G9U650
2.5 CDTI	88	08/06 →	D	G9U632, G9U650
	107	08/06 →	D	G9U632, G9U650
	73	10/03 →	D	G9U754
2.5 DTI	84	10/01 →	D	G9U720, G9U724, G9U750, G9U754
	84	10/01 →	D	G9U720, G9U724, G9U754

**Vivaro**

2.5 CDTI	107	08/06 →	D	G9MB6, G9U630
	107	08/06 →	D	G9U630
	84	08/06 →	D	G9U630
2.5 DTI	99	05/03 →	D	G9U730

**RENAULT**
**Avantime**

2.2 dCi	110	05/02 → 05/03	D	G9T712
---------	-----	---------------	---	--------

**Espace III**

2.2 dCi	85	07/00 → 10/02	D	G9T710
	95	10/00 → 10/02	D	G9T642, G9T710

**81855**
**350981855000**

**RENAULT**
**Espace IV**

2.2 dCi	102	02/06 →	D	G9T645
	110	11/02 →	D	G9T742, G9T743

**Laguna II, Grantour**

2.2 dCi	102	05/05 →	D	G9T600, G9T605, G9T706, G9T707
	102	05/05 →	D	G9T600, G9T706, G9T707
	85	04/04 → 10/05	D	G9T600
	110	10/01 →	D	G9T700, G9T702
	110	10/01 →	D	G9T702

**Master II**

2.2 dCi 90	66	09/00 →	D	G9T720, G9T722, G9T750
2.5 dCi	74	08/06 →	D	G9U650, G9U754
	84	01/04 →	D	G9U750
	88	08/06 →	D	G9U650
	107	08/06 →	D	G9U632
2.5 dCi 100	73	10/03 →	D	G9U754
2.5 dCi 120	84	10/01 →	D	G9U720, G9U724, G9U750, G9U754
	84	10/01 →	D	G9U720, G9U750, G9U754

**Traffic II**

2.5 dCi	84	08/07 →	D	G9U630
2.5 dCi 115	84	02/08 →	D	G9U630
2.5 dCi 135	99	03/01 →	D	G9U730
	99	05/03 →	D	G9U730
2.5 dCi 145	107	08/06 →	D	G9U630
2.5 DTi	99	03/03 → 07/03	D	G9U730

**81855**
**350981855000**

**RENAULT**
**Vel Satis**

	83	12/04 →	D	G9T600
	85	04/04 →	D	G9T600
2.2 dCi	102	09/04 →	D	G9T600, G9T606, G9T607, G9T700, G9T702
	110	06/02 →	D	G9T702, G9T703

**VAUXHALL**
**Movano**

2.2 DTI	66	09/00 → 05/10	D	G9T720, G9T722, G9T750
	66	09/00 → 05/10	D	G9T720, G9T750

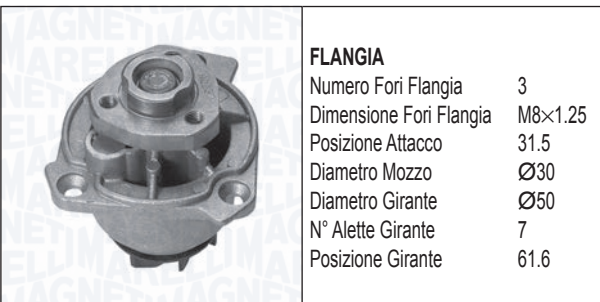
**81856**
**350981856000**

**SEAT**
**Toledo II**

2.3 V5	110	10/98 → 11/00	B	AGZ
2.3 V5 20V	125	09/00 → 11/03	B	AQN

**VOLKSWAGEN**
**Bora, Station Wagon**

2.3 V5	110	10/98 → 10/00	B	AGZ	08-1998 →
	110	05/99 → 10/00	B	AGZ	
	125	10/00 → 05/05	B	AQN	
2.3 V5 4motion	110	12/98 → 10/00	B	AGZ	08-1998 →
	110	05/99 → 10/00	B	AGZ	
	125	10/00 → 05/05	B	AQN	

**Golf IV, Variant, Cabrio**

2.3 V5	110	08/97 → 10/00	B	AGZ
	125	10/00 → 06/05	B	AQN
2.3 V5 4motion	110	12/98 → 10/00	B	AGZ
	125	10/00 → 06/05	B	AQN

**81856**
**350981856000**

**VOLKSWAGEN**
**New Beetle, Cabrio**

2.3 V5    125    10/00 → 09/10    B    AQN

**Passat IV, Variant**

2.3    110    10/96 → 11/00    B    AGZ

 VR5 Syncro/  
4motion    110    10/97 → 11/00    B    AGZ

**Passat V, Variant**

2.3 V5    125    11/00 → 05/05    B    AZX

 2.3 V5  
4motion    125    11/00 → 05/05    B    AZX

2.3 VR5    125    11/00 → 05/05    B    AZX

 2.3 VR5  
4motion    125    11/00 → 05/05    B    AZX

**81857**
**350981857000**

**PULEGGIA**

 Diametro Puleggia    Ø62.3  
 Numero Denti/Gole Puleggia    14  
 Altezza Puleggia    31.5  
 Posizione Attacco    63.5  
 Diametro Girante    Ø71  
 N° Alette Girante    7  
 Posizione Girante    14

**VOLVO**
**960 I, Station Wagon**

 2.9    150    08/90 → 07/94    B    B6304F,  
B6304FS,  
B6304G

 150    08/90 → 07/94    B    B6304F,  
B6304S

**960 II, Station Wagon**

2.5    125    07/94 → 12/96    B    B6254S

 125    08/94 → 12/96    B    B6254S    07-1994 →,  
→ 10-1996

2.9    150    07/94 → 12/96    B    B6304S

**S 90**

2.5    125    11/96 → 10/98    B    B6254FS

132    11/96 → 10/97    B    B6244FS

2.9    132    01/97 → 05/98    B    B6304S2    11-1996 →

150    01/97 → 05/98    B    B6304G

**V 90**

2.5    125    11/96 → 10/98    B    B6254FS

132    11/96 → 10/97    B    B6244FS

2.9    132    01/97 → 12/98    B    B6304S2

150    01/97 → 12/98    B    B6304G

**81858**
**350981858000**

**FLANGIA**

 Numero Fori Flangia    4  
 Dimensione Fori Flangia    M6x1  
 Posizione Attacco    72.2  
 Diametro Mozzo    Ø43.8  
 Diametro Girante    Ø60  
 N° Alette Girante    7  
 Posizione Girante    9.5

**SUBARU**
**Justy II**

1.3 4x4    63    04/01 → 11/03    B    G13BB

1.3 GX 4x4    50    10/95 → 11/03    B    EF13

**SUZUKI**
**Alto**

1.0    43    01/00 → 06/02    B    G10BB

**Alto III**

1.0    39    09/94 → 09/98    B    G10BB    01-1991 →

**Alto IV**

1.1    46    09/04 → 12/08    B    F10D, F10DN

**Baleno, Station Wagon**

1.3    52    09/96 → 05/02    B    G13BA

1.3 16V    63    03/97 → 05/02    B    G13BB

1.3 i 16V    63    07/95 → 05/02    B    G13BB    01-1994 →

**Swift II, Cabrio**

1.0    37    03/89 → 05/01    B    G10A

1.0 i    39    01/95 → 12/05    B    G10A

40    03/89 → 12/91    B    G10A

50    03/89 → 05/01    B    G13A

1.3    50    03/89 → 05/01    B    G13A

52    03/89 → 12/91    B    G13A

1.3 4WD    50    03/89 → 05/01    B    G13A

52    10/89 → 12/91    B    G13A

1.3 GTi    74    03/89 → 05/01    B    G13B

1.3 i    50    09/91 → 10/96    B    G13BA

**Wagon R+ II**

1.3    56    05/00 → 12/04    B    G13BB

1.3 4WD    56    10/01 →    B    G13BB



**81861**
**350981861000**

**PULEGGIA**

Diametro Puleggia	Ø131
Numero Denti/Gole Puleggia	6
Altezza Puleggia	29
Posizione Attacco	163
Diametro Girante	Ø60
N° Alette Girante	6
Posizione Girante	16

**KW**

**FIAT**
**500X**

1.6	81	11/14 →	B	55263842
	82	09/14 →	B	55263842

**JEEP**
**Renegade**

1.6	81	07/14 →	B	EJH
-----	----	---------	---	-----

**MINI**
**Mini I (R50,R52, R53)**

Cooper	85	06/01 → 09/06	B	W10B16A
Cooper S	125	07/04 → 09/06	B	W11B16A
One	55	04/03 → 09/06	B	W10B14A
	66	06/01 → 09/06	B	W10B16A

**81862**
**350981862000**

**PULEGGIA**

Diametro Puleggia	Ø115
Numero Denti/Gole Puleggia	6
Altezza Puleggia	23
Posizione Attacco	77.5
Diametro Girante	Ø62
N° Alette Girante	6
Posizione Girante	24.5

**KW**

**ALFA ROMEO**
**Mito**

1.3 MultiJet	59	12/13 →	D	199B8.000
	62	01/11 →	D	199B4.000
	66	09/08 →	D	199A3.000
	70	10/09 →	D	199B1.000

**CHRYSLER**
**Ypsilon**

1.3 Multijet	70	05/11 →	D	199B1.000
--------------	----	---------	---	-----------

**CITROËN**
**Nemo, Van**

1.3 HDi 75	55	10/10 →	D	FHZ (F13DTE5)
------------	----	---------	---	------------------

**81862**
**350981862000**

**KW**

**FIAT**
**500 II, 500C**

1.3 D Multijet	55	10/07 →	D	169A1.000
	70	12/09 →	D	199B1.000

**500L**

1.3 D Multijet	62	09/12 →	D	199B4.000
	70	06/14 →	D	330A1.000

**500X**

1.3 D Multijet	70	06/15 →	D	55266963
----------------	----	---------	---	----------

**Doblò I, Cargo**

1.3 D Multijet	55	10/05 → 01/10	D	199A2.000
	62	10/05 →	D	223A9.000
1.3 JTD	55	05/05 →	D	199A2.000

1.3 JTD 16V	51	05/04 → 12/06	D	188A8.000, 188A9.000
	51	12/04 → 05/05	D	188A9.000

1.3 JTD 16V Multijet	62	08/06 →	D	223A9.000
-------------------------	----	---------	---	-----------

**Doblò II, Cargo**

1.3 D Multijet	66	02/10 →	D	199A3.000, 263A2.000
----------------	----	---------	---	-------------------------

**Fiorino IV**

1.3 D Multijet	55	11/07 →	D	199A2.000, 199A9.000
	70	07/09 →	D	199B1.000, 330A1.000

**Grande Punto, Van**

1.3 D Multijet	51	07/08 →	D	199B2.000
	55	10/05 →	D	199A2.000
	56	06/09 →	D	199A2.000
	62	04/10 →	D	199B4.000, 223A9.000
	66	10/05 →	D	199A3.000

**Idea**

1.3 D Multijet	66	10/05 →	D	199A3.000
	70	05/08 →	D	199B1.000
1.3 JTD	51	01/04 →	D	188A9.000

**Linea**

1.3 D Multijet	66	06/07 →	D	199A3.000
	70	09/09 →	D	199A3.000

**Panda II, Van**

1.3 D Multijet	51	09/03 →	D	188A8.000, 188A9.000
	55	01/06 →	D	169A1.000
	55	06/06 →	D	169A1.000, 169A5.000

**81862**
**350981862000**

**FIAT**
**Panda II, Van**

1.3 D Multijet 4x4	51	10/04 →	D	188A8.000, 188A9.000
	55	01/06 →	D	169A1.000
	55	09/10 →	D	169A1.000, 169A5.000

**Panda III, Van**

1.3 D Multijet	55	02/12 →	D	199A1.000, 199A9.000
	70	04/15 →	D	199B1.000, 312B1.000, 330A1.000

1.3 D Multijet 4x4	55	06/12 →	D	199A1.000, 199A9.000
	59	06/14 →	D	225A2.000, 312A8.000, 312B2.000
	70	04/15 →	D	199B1.000, 312B1.000, 330A1.000

**Punto Evo, Van**

1.3 D Multijet	51	07/08 → 02/12	D	199B2.000
	55	10/09 → 02/12	D	199A2.000, 199A9.000
	62	10/09 → 02/12	D	199B4.000, 223A9.000
	66	10/09 → 02/12	D	199A3.000
	70	10/09 → 02/12	D	199B1.000

**Punto II, Cabrio, Van**

1.3 D Multijet	55	02/05 → 10/09	D	188A9.000
1.3 JTD	51	06/03 → 10/05	D	188A9.000
1.3 JTD 16V	51	06/03 →	D	188A9.000

**Punto III, Van**

1.3 D Multijet	55	03/12 →	D	199A2.000, 199A9.000
	59	12/13 →	D	199B8.000
	62	03/12 →	D	199B4.000
	66	01/10 → 02/12	D	199A3.000
	70	03/12 →	D	199B1.000

**Qubo**

1.3 D Multijet	55	02/08 →	D	199A2.000, 199A9.000
	70	07/10 →	D	199B1.000

**Siena I**

1.3 JTD	51	09/03 → 12/09	D	188A9.000
---------	----	---------------	---	-----------

**81862**
**350981862000**

**FIAT**
**Siena II**

1.3 JTD	51	11/07 →	D	188A9.000
---------	----	---------	---	-----------

**Strada**

1.3 D Multijet	62	05/06 →	D	223A9.000
	70	10/10 →	D	199B1.000

**Tipo II**

1.3 D Multijet	70	10/15 →	D	199B1.000, 55266963
----------------	----	---------	---	------------------------

**FORD**
**KA II**

1.3 TDCi	55	10/08 →	D	FD4
----------	----	---------	---	-----

**LANCIA**
**Musa**

1.3 D Multijet	51	10/04 → 09/12	D	188A9.000
	66	09/06 → 09/12	D	199A3.000
	70	03/09 → 09/12	D	199B1.000

**Ypsilon I**

1.3 D Multijet	55	09/06 → 12/11	D	199A2.000
	66	09/06 → 12/11	D	199A3.000
	77	05/07 → 12/11	D	199A3.000
1.3 JTD	51	10/03 → 12/11	D	188A9.000

**Ypsilon II**

1.3 Multijet	70	05/11 →	D	199B1.000
--------------	----	---------	---	-----------

**OPEL**
**Agila A**

1.3 CDTI	51	08/03 → 12/07	D	Z13DT
----------	----	---------------	---	-------

**Agila B**

1.3 CDTI	55	04/08 →	D	D13A, Z13DTJ
----------	----	---------	---	--------------

**Astra H, Station Wagon, GTC, Twin Top, Van**

1.3 CDTI	66	08/05 →	D	Z13DTH
----------	----	---------	---	--------

**Astra J, Station Wagon, GTC**

1.3 CDTI	70	12/09 →	D	A13DTE
----------	----	---------	---	--------

**Combo B**

1.3 CDTI 16V	51	10/04 →	D	Y13DT, Z13DT
	51	08/05 →	D	Z13DT
	55	10/05 →	D	Z13DTJ

**Combo C**

1.3 CDTI	66	02/12 →	D	A13FD
----------	----	---------	---	-------

**Corsa C, Van**

1.3 CDTI	51	06/03 → 12/09	D	Z13DT
1.3 CDTI 16V	51	08/05 →	D	Z13DT

**81862 350981862000**

**OPEL**
**Corsa D, Van**

1.3 CDTI	55	07/06 →	D	A13DTC, Z13DTJ
	66	07/06 →	D	Z13DTH
	70	06/10 →	D	A13DTE, A13DTR, Z13DTE

**Corsa E, Van**

1.3 CDTI	55	09/14 →	D	B13DTC
----------	----	---------	---	--------

**Meriva A**

1.3 CDTI	51	04/05 → 05/10	D	Y13DT, Z13DT
	55	09/03 → 05/10	D	Z13DTJ

**Meriva B**

1.3 CDTI	55	06/10 →	D	A13DTC
	70	06/10 →	D	A13DTE

**Tigra II Twin Top**

1.3 CDTI	51	06/04 →	D	Z13DT
----------	----	---------	---	-------

**PEUGEOT**
**Bipper, Tepee**

1.3 HDi 75	55	10/10 →	D	199A9.000
------------	----	---------	---	-----------

**SUZUKI**
**Ignis II**

1.3 DDiS	51	09/03 →	D	Z13DT
----------	----	---------	---	-------

**Splash**

1.3 CDTI	55	01/08 →	D	D13A, Z13DTJ
----------	----	---------	---	--------------

**Swift III**

1.3 DDiS	51	08/05 →	D	Z13DT
	55	08/05 →	D	D13A, Z13DTJ

**Swift IV**

1.3 DDiS	55	10/10 →	D	D13A
----------	----	---------	---	------

**Wagon R+ II**

1.3 DDiS	51	09/03 →	D	Z13DT
----------	----	---------	---	-------

**VAUXHALL**
**AGILA**

1.3 CDTI	55	01/08 → 11/14	D	D13A, Z13DTJ
----------	----	---------------	---	--------------

**ASTRA**

1.3 CDTI	70	12/09 →	D	A13DTE
----------	----	---------	---	--------

**CORSA**

1.3 CDTI 16V	52	08/00 → 09/06	D	Z13DT
-----------------	----	---------------	---	-------

**CORSAVAN**

1.3 CDTI 16V	52	04/04 → 06/06	D	Z13DT
-----------------	----	---------------	---	-------

**TIGRA**

1.3 CDTI	51	06/04 → 08/09	D	Z13DT
----------	----	---------------	---	-------

**81864 350981864000**



<b>PULEGGIA</b>	
Diametro Puleggia	Ø56.24
Numero Denti/Gole Puleggia	19
Altezza Puleggia	32
Posizione Attacco	59.6
Diametro Girante	Ø71
N° Alette Girante	7
Posizione Girante	21

**VOLVO**
**C 30**

D3	110	10/10 → 12/12	D	D5204T5
D4	130	10/10 → 12/12	D	D5204T
D5	120	10/06 → 12/12	D	D5244T9
	132	10/06 → 12/12	D	D5244T13, D5244T8

**C 70 II**

2.4 D	120	03/07 → 06/13	D	D5244T9
D3	110	10/10 → 06/13	D	D5204T5
D4	130	10/10 → 06/13	D	D5204T
D5	132	03/06 → 06/13	D	D5244T13, D5244T8

**S 40 II**

2.4 D5	132	03/06 →	D	D5244T13, D5244T8
D3	110	10/10 →	D	D5204T5
D4	130	10/10 →	D	D5204T

**S 60 I**

2.4 D	93	09/05 → 04/10	D	D5244T7
	120	09/05 → 01/09	D	D5244T5
	96	12/01 → 04/10	D	D5244T2
2.4 D5	120	07/01 → 04/10	D	D5244T
	136	09/05 → 04/10	D	D5244T4

**S 60 II**

2.4 D4AWD	140	03/15 →	D	D5244T21
D3	100	05/12 →	D	D5204T7
	120	04/10 → 04/12	D	D5204T2, D5204T3
D4	120	05/12 →	D	D5204T3
D5	151	04/10 →	D	D5244T10
	158	06/11 →	D	D5244T11, D5244T15
	169	04/14 →	D	D5244T15, D5244T23

**81864**
**350981864000**

**VOLVO**
**S 60 II**

D5 AWD	151	04/10 →	D	D5244T10	
	158	06/11 →	D	D5244T15	
	169	04/14 →	D	D5244T15, D5244T23	

**S 80 I**

2.4 D	96	10/01 → 07/06	D	D5244T2	
2.4 D5	120	08/01 → 07/06	D	D5244T	
2.8 T6	200	05/98 → 07/06	B	B6284T	01-2003 →
2.9	147	03/99 → 07/06	B	B6294S	01-2003 →
	150	05/98 → 07/06	B	B6304S3	01-2003 →
3.0	144	06/01 → 07/06	B	B6294S2	01-2003 →
3.0 T6	200	06/01 → 07/06	B	B6294T	01-2003 →

**S 80 II**

2.4 D	120	03/06 →	D	D5244T, D5244T5	
	129	01/10 →	D	D5244T14	
D3	100	05/12 →	D	D5204T7	
D3 / D4	120	01/10 →	D	D5204T2, D5204T3	
D5	136	03/06 →	D	D5244T4	
	151	01/10 →	D	D5244T10	
D5	158	06/11 →	D	D5244T11, D5244T15	
D5 AWD	136	01/07 →	D	D5244T4	
	151	01/10 →	D	D5244T10	
	158	06/11 →	D	D5244T15	

**V 40 II**

D3	110	03/12 → 03/15	D	D5204T6	
D4	130	03/12 →	D	D5204T4	

**V 50**

2.4 D5	132	03/06 →	D	D5244T13, D5244T8	
2.4 Tdi	120	05/07 →	D	D5244T9	
D3	110	10/10 →	D	D5204T5	
D4	130	10/10 →	D	D5204T	

**V 60**

2.4 D5	158	06/11 →	D	D5244T11, D5244T15	
2.4 D5 AWD	158	06/11 →	D	D5244T15	
2.4 D5 Hybrid AWD	120	03/15 →		D87PHEV	
2.4 Hybrid D6 AWD	158	06/12 →		D82PHEV	

**81864**
**350981864000**

**VOLVO**
**V 60**

D3	100	12/12 →	D	D5204T7	
D3 / D4	120	09/10 →	D	D5204T2, D5204T3	
D4 AWD	120	12/12 →	D	D5244T17	
	133	10/13 →	D	D5244T12	
	140	03/15 →	D	D5244T21	
D5	151	09/10 →	D	D5244T10	
	169	04/14 →	D	D5244T23	
D5 AWD	151	09/10 →	D	D5244T10	
	169	04/14 →	D	D5244T15, D5244T23	
D6 Hybrid AWD	162	03/15 →		D97PHEV	

**V 70 II**

2.4 D	93	05/05 → 08/07	D	D5244T7	
	96	12/01 → 08/07	D	D5244T2	
2.4 D5	120	08/01 → 08/07	D	D5244T, D5244T5	
	136	12/05 → 08/07	D	D5244T4	
2.4 D5 AWD	120	03/03 → 08/07	D	D5244T, D5244T2, D5244T5	
	136	12/05 → 08/07	D	D5244T4	

**V 70 III**

2.4 D	120	08/07 →	D	D5244T5	
	129	10/09 →	D	D5244T14	
D3	100	03/10 →	D	D5204T7	
D3 / D4	120	03/10 →	D	D5204T2, D5204T3	
D4 AWD	120	01/13 →	D	D5244T17	
	133	10/13 →	D	D5244T12	
D5	136	08/07 →	D	D5244T4	
	151	12/09 →	D	D5244T10	
	158	06/11 →	D	D5244T11, D5244T15	
D5 AWD	136	10/07 →	D	D5244T4	
	151	12/09 →	D	D5244T10	
	158	06/11 →	D	D5244T11, D5244T15	

**81864** **350981864000**

**VOLVO**
**XC 60**

2.4 D	129	07/09 →	D	D5244T14
D3	100	04/12 →	D	D5204T7
D3 / D4	120	03/10 →	D	D5204T2, D5204T3
D4 AWD	133	10/13 →	D	D5244T12
	140	03/15 →	D	D5244T21
D5	158	06/11 →	D	D5244T11, D5244T15
D5 AWD	151	07/09 → 06/11	D	D5244T10
	158	06/11 →	D	D5244T11, D5244T15
	162	03/15 →	D	D5244T20, D5244T22
	169	04/14 →	D	D5244T23

**XC 70 I Cross Country**

2.4 D5 AWD	136	12/05 → 08/07	D	D5244T4
2.4 D5 XC AWD	120	09/02 → 08/07	D	D5244T

**XC 70 II**

2.4 D	129	01/10 →	D	D5244T14
2.4 D / D4 AWD	120	08/07 →	D	D5244T16, D5244T17, D5244T5
D3	120	08/11 →	D	D5204T2, D5204T3
D3 AWD	120	08/11 →	D	D5204T2
D4 AWD	133	10/13 →	D	D5244T12
D5 AWD	136	08/07 →	D	D5244T4
	151	12/09 →	D	D5244T10
	158	06/11 →	D	D5244T11, D5244T15
	162	03/15 →	D	D5244T20

**XC 90 I**

D3 / D5	120	04/09 →	D	D5244T5
D5	147	01/11 →	D	D5244T18
	120	10/02 →	D	D5244T, D5244T5
	136	05/06 →	D	D5244T4
D5 AWD	120	10/07 →	D	D5244T5
T6	200	10/02 →	B	B6294T

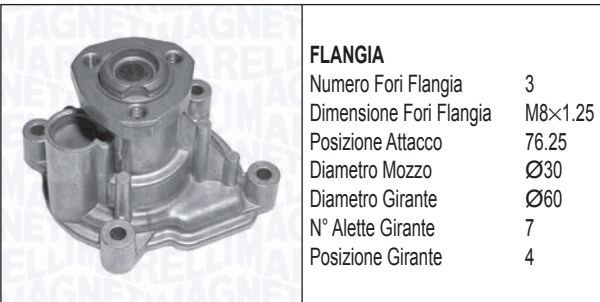
**81865** **350981865000**

**FLANGIA**

Numero Fori Flangia	3
Dimensione Fori Flangia	M8×1.25
Posizione Attacco	76.25
Diametro Mozzo	Ø30
Diametro Girante	Ø60
N° Alette Girante	7
Posizione Girante	4

**AUDI**
**A3 II, Sportback, Cabriolet**

1.6 FSI	85	08/03 → 09/07	B	BAG, BLF, BLP
	85	09/04 → 09/07	B	BLF, BLP

**SEAT**
**Cordoba III, Vario**

1.6 16V	77	11/06 → 11/09	B	BTS
---------	----	---------------	---	-----

**Ibiza IV**

1.6 16V	77	11/06 → 11/09	B	BTS
---------	----	---------------	---	-----

**Ibiza V**

1.6	77	05/08 →	B	BTS	→ T: 6J9002800
	77	02/12 →	B	BTS	

**SKODA**
**Fabia II, Station Wagon, Van**

1.6	77	04/07 → 12/14	B	BTS, CFNA
-----	----	---------------	---	-----------

**Octavia II, Station Wagon**

1.6 FSI	85	02/04 → 10/08	B	BLF
---------	----	---------------	---	-----

**Rapid II**

1.6	77	07/12 →	B	CFNA
-----	----	---------	---	------

**Roomster, Van**

1.6	77	09/06 → 05/15	B	BTS, CFNA
-----	----	---------------	---	-----------

**VOLKSWAGEN**
**Eos**

1.6 FSI	85	06/06 → 05/08	B	BLF
---------	----	---------------	---	-----

**Golf V, Plus, Variant**

1.4 FSI	66	10/03 → 07/06	B	BKG, BLN
	66	07/05 → 11/06	B	BLN
1.6 FSI	85	10/03 → 07/08	B	BAG, BLF, BLP
	85	01/05 → 05/08	B	BLF

**Jetta III**

1.6 FSI	85	09/05 → 10/10	B	BLF
---------	----	---------------	---	-----

**Passat VI, Variant, CC**

1.6 FSI	85	03/05 → 06/08	B	BLF
---------	----	---------------	---	-----

**81865 350981865000**



**VOLKSWAGEN**

**Polo V (9N)**

1.4 FSI	63	02/02 → 07/06	B	AXU	
1.6 16V Polo VI (6R)	77	05/06 → 11/09	B	BTS	

1.6	77	05/10 →	B	CFNA, CLSA	
-----	----	---------	---	------------	--

**Touran I**

1.6 FSI	85	02/03 → 01/07	B	BAG, BLF, BLP	
---------	----	---------------	---	---------------	--

**81866 350981866000**



<b>FLANGIA</b>	
Numero Fori Flangia	3
Dimensione Fori Flangia	M8×1.25
Posizione Attacco	31.5
Diametro Mozzo	Ø30
Diametro Girante	Ø66.5
N° Alette Girante	7
Posizione Girante	63.8



**AUDI**

**A3 II, Sportback, Cabriolet**

3.2 V6 quattro	184	07/03 → 05/09	B	BDB, BMJ, BUB	
	184	09/04 → 05/09	B	BMJ, BUB	

**Q7 I**

3.6 FSI	206	08/06 → 05/10	B	BHK	
---------	-----	---------------	---	-----	--

**TT I, Roadster**

3.2 VR6 quattro	184	07/03 → 06/06	B	BHE, BPF	
-----------------	-----	---------------	---	----------	--

**TT II, Roadster**

3.2 V6 quattro	184	08/06 → 06/10	B	BUB	
----------------	-----	---------------	---	-----	--

**SEAT**

**Alhambra I**

2.8 V6	150	06/00 → 03/10	B	AUE, AYL	
2.8 V6 4motion	150	06/00 → 03/10	B	AUE, AYL	

**Leon I**

2.8	150	05/02 → 06/04	B	BDE	
2.8 Cupra 4	150	02/01 → 06/06	B	AUE	10-2001→

**81866 350981866000**



**SKODA**

**Superb II, Station Wagon**

3.6 FSI 4x4	191	04/09 → 05/15	B		
3.6 V6 4x4	191	11/08 → 05/15	B	CDVA	

**VOLKSWAGEN**

**Bora, Station Wagon**

2.8 V6 4motion	150	03/99 → 05/05	B	AQP, AUE, BDE	M: BDE
----------------	-----	---------------	---	---------------	--------

**CC**

3.6 FSI 4motion	220	11/11 →	B	BWS	
-----------------	-----	---------	---	-----	--

**Eos**

3.2 V6	184	06/06 → 05/09	B	BUB, CBRA	
3.6 V6	191	05/09 → 11/10	B	CDVA	

**Golf IV, Variant, Cabrio**

3.2 R32 4motion	177	09/02 → 06/05	B	BFH, BML	
-----------------	-----	---------------	---	----------	--

**Golf V, Plus, Variant**

3.2	184	09/05 → 11/08	B	BUB	
3.2 R32 4motion	177	01/04 → 11/08	B	BJS	
	184	11/05 → 11/08	B	BUB, CBRA	

**Multivan V**

3.2 V6	170	02/04 → 06/04	B	BDL	
	173	02/04 → 11/09	B	BKK, CFLA	
3.2 V6 4motion	173	07/04 → 11/09	B	BKK, CFLA	

**New Beetle, Cabrio**

RSI 3.2 4motion	165	04/00 → 05/01	B	AXJ	
-----------------	-----	---------------	---	-----	--

**Passat VI, Variant, CC**

3.2 FSI 4motion	184	11/05 → 07/10	B	AXZ	
3.6 FSI 4motion	206	06/08 → 01/12	B	BLV, CNNA	
	220	06/08 → 05/10	B	BWS	
3.6 R36 4motion	220	04/07 → 07/10	B	BWS	

**Passat VII, Variant, CC, AllTrack**

3.6 FSI 4motion	220	01/11 → 12/14	B	BWS	
-----------------	-----	---------------	---	-----	--

**Phaeton**

3.2 V6	177	04/02 →	B	AYT, BKL	
3.2 V6 4motion	177	02/04 →	B	BKL, BRK	
3.6 V6 4motion	206	11/08 →	B	CHNA, CMVA	

**81866 350981866000**

**VOLKSWAGEN**
**Sharan I**

2.8 V6 24V 150 04/00 → 03/10 B AYL T →: 035.001

2.8 V6 24V 4motion 150 04/00 → 03/10 B AYL T →: 035.001

**Touareg I**

3.2 V6	162	10/02 → 11/06	B	AZZ, BAA, BKJ, BMV, BMX, BRJ
	177	11/04 → 11/06	B	BMV

3.6 V6 FSI 206 10/05 → 05/10 B BHK, BHL

**Transporter IV**

2.8 VR6 150 06/00 → 04/03 B AMV

**Transporter V**

3.2 4motion 173 11/03 → 11/09 B BKK, CFLA

170 02/04 → 06/04 B BDL

3.2 V6 173 08/03 → 05/06 B BKK

173 02/04 → 11/09 B BKK, CFLA

3.2 V6 4motion 173 11/03 → 11/09 B BKK, CFLA

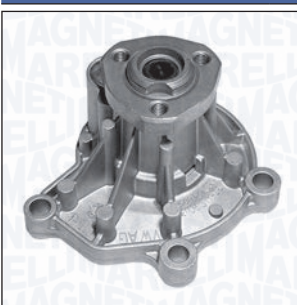
**81867 350981867000**

**FLANGIA**

Numero Fori Flangia	3
Dimensione Fori Flangia	M8x1.25
Posizione Attacco	69
Diametro Mozzo	Ø30
Diametro Girante	Ø64
N° Alette Girante	8
Posizione Girante	20.6

**SEAT**
**Cordoba III, Vario**

1.2 47 10/02 → 06/06 B AZQ, BME

1.2 12V 51 05/06 → 11/09 B BXV

**Ibiza IV**

1.2 44 06/07 → 05/08 B BBM

47 02/02 → 06/06 B AZQ, BME

1.2 12V 51 05/06 → 11/09 B BXV

**Ibiza V**

1.2 44 07/09 → B CGPB

51 03/08 → B BZG, CGPA, CJLB

**Toledo IV**

1.2 55 07/12 → B CGPC

**81867 350981867000**

**SKODA**
**Fabia I, Station Wagon, Van**

1.2 40 08/02 → 03/08 B AWY, BMD

47 01/03 → 03/08 B AZQ, BME

**Fabia II, Station Wagon, Van**

1.2 44 12/06 → 12/14 B BBM, CHFA

51 01/07 → 12/14 B BZG, CEVA, CGPA, CHTA

1.2 12V 44 11/11 → 12/14 B CGPB

**Rapid II**

1.2 55 07/12 → B CGPC

**Roomster, Van**

1.2 47 05/06 → 01/07 B BME

51 01/07 → 05/15 B BZG, CGPA

**VOLKSWAGEN**
**Fox I**

1.2 40 04/05 → B BMD, CHFB

44 09/10 → B CHFA

**Polo V (9N)**

1.2 40 01/02 → 05/07 B AWY, BMD

44 05/07 → 11/09 B BBM

1.2 12V 47 10/01 → 07/07 B AZQ, BME

51 05/07 → 11/09 B BZG

**Polo VI (6R)**

1.2 44 06/09 → B CGPB

51 06/09 → B CGPA

**81868 350981868000**

**PULEGGIA**

Diametro Puleggia	Ø52
Altezza Puleggia	37
Posizione Attacco	48.5
Diametro Girante	Ø70.3
N° Alette Girante	10
Posizione Girante	7.8

**NISSAN**
**Primera III, Hatchback, Station Wagon**

1.9 dCi 88 04/03 → D F9Q

**81868**
**350981868000**

**KW**

**RENAULT**
**Grand Scénic II**

1.9 dCi	85	05/05 → 01/09	D	F9Q803, F9Q804, F9Q812
	81	05/05 →	D	F9QE804
	88	04/04 →	D	F9Q812
	96	05/05 →	D	F9Q816, F9Q818, F9QEE804, F9QJ803

**Laguna II, Grantour**

1.9 dCi	68	03/04 →	D	F9Q664
	81	01/05 →	D	F9Q674, F9Q758
	96	05/05 →	D	F9Q758, F9Q759

**Megane II, Station Wagon, Coupé-Cabrio**

1.9 dCi	66	11/02 → 12/05	D	F9Q808
	68	03/04 → 08/06	D	F9Q808
	81	05/05 → 03/09	D	F9Q804, F9Q816, F9Q818
	81	05/05 → 02/08	D	F9Q804, F9Q818
	85	11/02 → 02/08	D	F9Q804, F9Q816, F9Q818
	85	05/05 → 07/09	D	F9Q818
	88	09/03 → 03/09	D	F9Q800
	96	05/05 → 02/07	D	F9Q803, F9Q804
	96	05/05 → 12/09	D	F9Q803, F9Q804, F9Q816, F9Q818
	81	05/05 →	D	F9Q803, F9Q804, F9Q816, F9Q818
88	11/02 → 02/08	D	F9Q800	

**Scénic II**

1.9 D	85	06/06 →	D	F9Q812, F9QJ803
-------	----	---------	---	--------------------

**81868**
**350981868000**

**KW**

**RENAULT**
**Scénic II**

1.9 dCi	92	06/03 →	D	F9Q804
	81	05/05 →	D	F9Q804
	88	06/03 →	D	F9Q812
	96	05/05 →	D	F9Q804, F9Q816, F9Q818, F9QJ803

**SUZUKI**
**Grand Vitara II**

1.9 DDiS	95	10/05 → 02/15	D	F9QB
----------	----	---------------	---	------

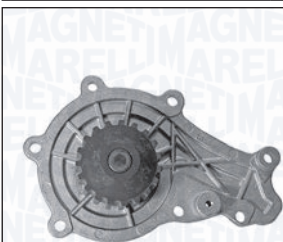
**81869**
**350981869000**

**PULEGGIA**

Diametro Puleggia	Ø56
Numero Denti/Gole Puleggia	19
Altezza Puleggia	30
Posizione Attacco	39
Diametro Girante	Ø72
N° Alette Girante	20
Posizione Girante	29

**KW**

**CITROËN**
**Berlingo I, Van**

1.6 HDI 110	80	08/05 →	D	9HZ (DV6TED4)
1.6 HDI 75	55	07/05 →	D	9HW (DV6BTED4), DV6B
1.6 HDI 90	66	07/05 →	D	9HX (DV6ATED4)

**Berlingo II, Van**

1.6 BlueHDI 100	73	12/14 →	D	BHY (DV6FD)
1.6 BlueHDI 120	88	12/14 →	D	BHZ (DV6FC)
1.6 BlueHDI 75	55	04/15 →	D	9HN (DV6ETED), BHW (DV6FE)
1.6 HDi 110	80	04/08 →	D	9HZ (DV6TED4)
	82	07/10 →	D	9HL (DV6C), 9HR (DV6C)



**81869** **350981869000**

**KW**

**CITROËN**
**Berlingo II, Van**

1.6 HDi 115	84	07/10 →	D	9HL (DV6C)
	84	07/10 →	D	9HR (DV6C)
1.6 HDi 75	55	04/08 →	D	9HT (DV6BTED4)
	55	04/08 →	D	9HT (DV6BUTED4)
1.6 HDi 90	66	07/10 →	D	9HF (DV6DTED)
	66	04/08 →	D	9HX (DV6ATED4)
	68	07/10 →	D	9HP (DV6DTED)
1.6 HDi 90 16V	66	04/08 →	D	9HP (DV6DTED), 9HX (DV6ATED4)
				9HS (DV6TED4BU), 9HX (DV6ATED4)

**C 2, Van**

1.6 HDi	80	09/05 →	D	9HZ (DV6TED4)
---------	----	---------	---	---------------

**C 3 I, Pluriel**

1.6 16V HDi	66	10/05 →	D	9HX (DV6ATED4)
	80	09/05 →	D	9HZ (DV6TED4)

**C 3 II, Picasso**

1.6 BlueHDi 100	73	07/14 →	D	BHY (DV6FD)
1.6 BlueHDi 75	55	04/15 →	D	BHW (DV6FE)
1.6 HDi	66	02/09 →	D	9HX (DV6ATED4)
	68	11/09 →	D	9HP (DV6DTED)
	80	02/09 →	D	9HZ (DV6TED4)
1.6 HDi 110	82	11/09 →	D	9HR (DV6C)
1.6 HDi 115	84	09/12 →	D	9HD (DV6C)
1.6 HDi 90	66	11/09 →	D	9HX (DV6ATED4)
	68	07/10 →	D	9HP (DV6DTED)

**81869**
**350981869000**

**KW**

**CITROËN**
**C 4 Cactus**

1.6 BlueHDi 100	73	09/14 →	D	BHY (DV6FD)
1.6 HDi 90	68	09/14 →	D	9HP (DV6DTED)

**C 4 Aircross**

1.6 HDi 115	84	04/12 →	D	9HL (DV6C)
1.6 HDi 115 AWC	84	05/12 →	D	9HL (DV6C)

**C 4 I, Coupé, Picasso, Grand Picasso**

1.6 HDi	66	11/04 → 07/11	D	9HX (DV6ATED4)
	80	11/04 → 07/11	D	9HY (DV6TED4), 9HZ (DV6TED4)
1.6 HDi 110	82	09/10 →	D	9HL (DV6C), 9HR (DV6C)
	82	09/10 → 08/13	D	9HR (DV6C)

**C 4 II, Picasso, Grand Picasso**

1.6 BlueHDi 100	73	01/15 →	D	BHY (DV6FD)
1.6 BlueHDi 115	85	08/14 →	D	BHX (DV6FC)
1.6 BlueHDi 120	88	07/14 →	D	BHZ (DV6FC)
1.6 HDi / BlueHDi 115	85	09/13 →	D	9HC (DV6C), BHX (DV6FC)
1.6 HDi 110	82	11/09 →	D	9HR (DV6C)
1.6 HDi 115	84	07/12 →	D	9HD (DV6C), 9HR (DV6C)
1.6 HDi 90	68	09/13 →	D	9HP (DV6DTED)

**C 5 II, Break**

1.6 HDi	80	09/04 →	D	9HY (DV6TED4), 9HZ (DV6TED4)
---------	----	---------	---	------------------------------

**C 5 III, Break**

1.6 HDi	80	02/08 →	D	9HZ (DV6TED4)
1.6 HDi 110	82	07/10 →	D	9HL (DV6C), 9HR (DV6C)

**81869 350981869000**

**CITROËN**
**C 5 III, Break**

1.6 HDi 115	84	01/12 →	D	9HL (DV6C), 9HR (DV6C)
-------------	----	---------	---	---------------------------

**C-Elysee**

1.6 BlueHDi 100	73	11/14 →	D	BHY (DV6FD)
-----------------	----	---------	---	-------------

1.6 HDi 92	68	11/12 →	D	9HJ (DV6DTEDM), 9HP (DV6DTEd)
------------	----	---------	---	----------------------------------

**DS 3, Cabrio**

1.6 BlueHDi 100	73	07/14 → 07/15	D	BHY (DV6FD)
-----------------	----	---------------	---	-------------

1.6 BlueHDi 120	88	10/13 → 07/15	D	BHZ (DV6FC)
-----------------	----	---------------	---	-------------

1.6 HDi 110	82	11/09 → 07/15	D	9HR (DV6C)
-------------	----	---------------	---	------------

1.6 HDi 115	84	08/12 → 07/15	D	9HD (DV6C), 9HL (DV6C)
-------------	----	---------------	---	---------------------------

	85	10/13 → 07/15	D	BHX (DV6FC)
--	----	---------------	---	-------------

1.6 HDi 90	68	11/09 → 07/15	D	9HP (DV6DTEd)
------------	----	---------------	---	---------------

	69	01/13 → 07/15	D	9HP (DV6DTEd)
--	----	---------------	---	---------------

DS 4 1.6 HDi 110	81	04/11 → 07/15		
------------------	----	---------------	--	--

1.6 HDi 110	82	04/11 → 07/15	D	9HR (DV6C)
-------------	----	---------------	---	------------

1.6 HDi 115	84	08/12 → 07/15	D	9HD (DV6C), 9HL (DV6C)
-------------	----	---------------	---	---------------------------

1.6 HDi 90	68	05/11 → 07/15	D	9HP (DV6DTEd)
------------	----	---------------	---	---------------

**DS 5**

1.6 BlueHDi 120	88	07/14 → 07/15	D	BHZ (DV6FC)
-----------------	----	---------------	---	-------------

1.6 HDi	85	11/13 → 07/15	D	BHX (DV6FC)
---------	----	---------------	---	-------------

1.6 HDi 110	82	11/11 → 07/15	D	9HR (DV6C)
-------------	----	---------------	---	------------

1.6 HDi 115	84	06/12 → 07/15	D	9HD (DV6C)
-------------	----	---------------	---	------------

**Jumpy III**

1.6 HDi 90 16V	66	01/07 →	D	9HU (DV6UTED4)
----------------	----	---------	---	----------------

1.6 HDi 90 8V	66	01/07 →	D	9HH (DV6DUM), 9HM (DV6UC)
---------------	----	---------	---	------------------------------

**81869 350981869000**

**CITROËN**
**Xsara, Break, Coupé, Picasso, Van**

1.6 HDi	66	09/05 →	D	9HX (DV6ATED4)
---------	----	---------	---	----------------

	80	05/04 →	D	9HY (DV6TED4), 9HZ (DV6TED4)
--	----	---------	---	---------------------------------

**DS**
**DS 3**

1.6 BlueHDi 100	73	04/15 →	D	
-----------------	----	---------	---	--

1.6 BlueHDi 120	88	07/15 →	D	
-----------------	----	---------	---	--

**DS 4 / DS 4 CROSSBACK**

1.6 BlueHDi 120	88	07/15 →	D	
-----------------	----	---------	---	--

**FIAT**
**Scudo II**

1.6 D Multijet	66	01/07 →	D	9HU
----------------	----	---------	---	-----

**FORD**
**B-Max, Van**

1.5 TDCi	55	10/12 →	D	UGJC
----------	----	---------	---	------

1.6 TDCi	70	10/12 →	D	T3JB
----------	----	---------	---	------

**C-Max I**

1.6 TDCi	66	02/07 → 09/10	D	GPDA, HHDA, HHDB
----------	----	---------------	---	---------------------

	74	02/07 → 09/10	D	G8DC, MTDa
--	----	---------------	---	------------

	80	02/07 → 09/10	D	G8DA, G8DB, G8DD
--	----	---------------	---	---------------------

**C-Max II, Van**

1.6 TDCi	85	12/10 →	D	T1DA, T1DB
----------	----	---------	---	------------

**Ecosport II**

1.5 TDCi	66	10/13 →	D	UGJE
----------	----	---------	---	------

**Fiesta V, Van**

1.6 TDCi	66	11/04 → 06/08	D	HHJA, HHJB
----------	----	---------------	---	------------

**Fiesta VI, Van**

1.4 TDCi	51	07/10 →	D	F6JD, KVJA
----------	----	---------	---	------------

1.5 TDCi	55	09/12 →	D	UGJC
----------	----	---------	---	------

1.6 TDCi	55	06/08 →	D	HHJF, UBJA
----------	----	---------	---	------------

	66	06/08 →	D	HHJC, HHJD, HHJE
--	----	---------	---	---------------------

	70	02/10 →	D	T3JA, TZJA, TZJB
--	----	---------	---	---------------------

**81869 350981869000**

**FORD**
**Focus C-Max**

1.6 TDCi	66	02/05 → 03/07	D	HHDA, HHDB
	80	10/03 → 03/07	D	G8DA, G8DB

**Focus II, Station Wagon, Cabrio**

1.6 TDCi	66	01/05 → 09/12	D	GPDA, GPDB, GPDC, HHDA, HHDB
	66	07/04 → 09/12	D	GPDA, GPDC, HHDA, HHDB
	66	04/05 → 09/12	D	HHDA, HHDB
	74	07/04 → 09/12	D	G8DC, MTDA
	80	07/04 → 09/12	D	G8DA, G8DB, G8DD, G8DE, G8DF
	81	12/07 → 09/12	D	G8DA

**Focus III, Station Wagon, Van**

1.6 TDCi	70	07/10 →	D	T3DA, T3DB
	85	07/10 →	D	T1DA, T1DB
1.6 TDCi ECOnetic	77	05/12 →	D	NGDA, NGDB

**Fusion**

1.6 TDCi	66	11/04 → 12/12	D	HHJA, HHJB
----------	----	---------------	---	------------

**Galaxy II**

1.6 TDCi	85	02/11 → 06/15	D	T1WA, T1WB
----------	----	---------------	---	------------

**Mondeo IV, Station Wagon**

1.6 TDCi	85	02/11 → 09/14	D	T1BA, T1BB, T1BC
----------	----	---------------	---	------------------

**S-Max**

1.6 TDCi	85	02/11 →	D	T1WA, T1WB
----------	----	---------	---	------------

**Tourneo II Connect, Courier, Custom**

1.6 TDCi	55	09/13 →	D	UBGA
	70	09/13 →	D	TZGA, TZGB
	85	09/13 →	D	T1GA

**Transit Connect II, Courier**

1.6 TDCi	55	02/13 →	D	UBGA
	70	02/13 →	D	TZGA, TZGB
	85	02/13 →	D	T1GA

**MAZDA**
**2 II, Saloon**

1.6 MZ-CD	66	10/08 → 06/15	D	Y406, Y646
	70	06/11 → 06/15	D	Y655, Y661

**3 I, Saloon**

1.6 DI Turbo	80	06/04 → 06/09	D	Y601
1.6 MZ-CD	66	06/06 → 12/09	D	Y406

**81869 350981869000**

**MAZDA**
**3 II, Saloon**

1.6 MZR CD	80	12/08 →	D	Y601, Y642
	80	12/08 →	D	Y642
	85	11/10 →	D	Y650, Y655

**5 II**

1.6 CD	85	09/10 →	D	Y650, Y655
--------	----	---------	---	------------

**MINI**
**Mini II (R55, R56, R57, R58, R59)**

Cooper D	80	10/07 → 02/10	D	9HZ (DV6TED4)
	80	11/06 → 09/10	D	9HZ (DV6TED4), W16D16
One D	66	06/09 → 07/10	D	9HZ (DV6TED4)

**MITSUBISHI**
**ASX, Van**

1.6 DI-D	84	07/15 →	D	9HD
1.6 DI-D 4WD	84	07/15 →	D	9HD

**PEUGEOT**
**205 II, Van**

1.6 HDi 110	80	05/04 →	D	9HY (DV6TED4), 9HZ (DV6TED4)
-------------	----	---------	---	------------------------------

**206, CC, Van**

1.6 HDi 110	80	04/05 →	D	9HZ (DV6TED4)
-------------	----	---------	---	---------------

**207, Station Wagon, CC, Van**

1.6 HDi	66	02/06 →	D	9HV (DV6TED4), 9HX (DV6ATED4)
	66	06/07 →	D	9HX (DV6ATED4)
	68	11/09 →	D	9HP (DV6DTED)
	80	02/06 →	D	9HY (DV6TED4), 9HZ (DV6TED4)
	80	02/07 →	D	9HZ (DV6TED4)
	82	08/09 →	D	9HR (DV6C)
1.6 HDi 110	82	08/09 →	D	9HR (DV6C)

**81869**
**350981869000**

**PEUGEOT**
**208**

1.6 BlueHDi 100	73	01/15 →	D	BHY (DV6FD)
1.6 BlueHDi 120	88	11/13 →	D	BHZ (DV6FC)
1.6 HDi	68	03/12 →	D	9HP (DV6DTEd)
	84	03/12 →	D	9HD (DV6CTED)
	85	04/14 →	D	BHX (DV6FC)
1.6 HDi / BlueHDi 75	55	01/13 →	D	9HK (DV6ETEDM), BHW (DV6FE)

**301**

1.6 HDi 90	68	11/12 →	D	9HF (DV6DTEd)
------------	----	---------	---	---------------

**307, Station Wagon, CC**

1.6 HDi	66	04/05 →	D	9HV (DV6ATED4)
	66	04/05 →	D	9HV (DV6ATED4), 9HV (DV6TED4), 9HX (DV6ATED4)
1.6 HDi 110	80	02/04 →	D	9HY (DV6TED4), 9HZ (DV6TED4)
1.6 HDi 90	66	12/06 →	D	9HV (DV6ATED4), 9HX (DV6ATED4)

**308 I, Station Wagon, CC**

1.6 HDi	66	09/07 →	D	9HV (DV6ATED4), 9HX (DV6ATED4)
	66	09/07 →	D	
	68	11/09 →	D	9HP (DV6DTEd)
	80	09/07 →	D	9HZ (DV6TED4)
	82	12/09 →	D	9HR (DV6C)
	84	03/13 →	D	

**81869**
**350981869000**

**PEUGEOT**
**308 II Station Wagon**

1.6 BlueHDi 100	73	04/14 →	D	BHY (DV6FD)
1.6 BlueHDi 120	88	11/13 →	D	BHZ (DV6FC)
1.6 HDi	68	09/13 →	D	
1.6 HDi / BlueHDi 115	85	09/13 →	D	9HC (DV6C), BHZ (DV6FC)
1.6 HDi 100	73	04/14 →	D	BHY (DV6FD)
1.6 HDi 92	68	03/14 →	D	

**407, Station Wagon, Coupé**

1.6 HDi 110	80	05/04 →	D	9HZ (DV6TED4)
-------------	----	---------	---	---------------

**508, Station Wagon**

1.6 BlueHDi 120	88	03/14 →	D	BHZ (DV6FC)
1.6 HDi	82	11/10 →	D	9HR (DV6C)
	84	02/12 →	D	9HD (DV6CTED)
	85	09/14 →	D	BHX (DV6FC)

**1007**

1.6 HDi	80	06/07 →	D	9HZ (DV6TED4)
---------	----	---------	---	---------------

**2008**

1.6 BlueHDi 100	73	01/15 →	D	BHY (DV6FD)
1.6 BlueHDi 120	88	07/14 →	D	BHZ (DV6FC)
1.6 BlueHDi 75	55	01/15 →	D	BHW (DV6FE)
1.6 HDi	68	03/13 →	D	9HP (DV6DTEd)
	84	03/13 →	D	9HD (DV6CTED)
	85	07/14 →	D	BHX (DV6FC)

**3008**

1.6 BlueHDi 120	88	05/14 →	D	BHZ (DV6FC)
1.6 HDi	80	06/09 →	D	9HZ (DV6TED4)
	82	08/10 →	D	9HR (DV6C)
	84	03/13 →	D	9HD (DV6CTED)

**81869** **350981869000**

**KW**

**PEUGEOT**
**4008**

1.6 HDi AWC	84	05/12 →	D	9HD (DV6C)
-------------	----	---------	---	------------

**5008**

1.6 BlueHDi 120	88	05/14 →	D	BHZ (DV6FC)
-----------------	----	---------	---	-------------

1.6 HDi	80	09/09 →	D	9HZ (DV6TED4)
---------	----	---------	---	---------------

1.6 HDi	82	08/10 →	D	9HR (DV6C)
---------	----	---------	---	------------

1.6 HDi	84	03/13 →	D	9HD (DV6CTED)
---------	----	---------	---	---------------

**Expert II, Tepee**

1.6 HDi 90	66	01/07 →	D	9HU (DV6UTED4)
------------	----	---------	---	----------------

1.6 HDi 90 16V	66	01/07 →	D	9HU (DV6UTED4)
----------------	----	---------	---	----------------

**Partner I**

1.6 HDi 75	55	02/06 →	D	9HW (DV6BTED4)
------------	----	---------	---	----------------

1.6 HDi 90	66	10/05 →	D	9HX (DV6ATED4)
------------	----	---------	---	----------------

**Partner II, Tepee**

1.6 HDi	55	04/08 →	D	9HN (DV6ETED4), 9HT (DV6BTED4), 9HW (DV6BTED4)
---------	----	---------	---	--

1.6 HDi	55	04/08 →	D	9HT (DV6BTED4), 9HW (DV6BTED4)
---------	----	---------	---	--------------------------------

1.6 HDi	80	04/08 →	D	9HZ (DV6TED4)
---------	----	---------	---	---------------

1.6 HDi	82	08/10 →	D	9HL (DV6C)
---------	----	---------	---	------------

1.6 HDi	84	03/13 →	D	9HL (DV6C)
---------	----	---------	---	------------

1.6 HDi 16V	66	04/08 →	D	9HS (DV6TED4BU), 9HX (DV6ATED4)
-------------	----	---------	---	---------------------------------

1.6 HDi 16V	66	04/08 →	D	9HV (DV6TED4), 9HX (DV6ATED4)
-------------	----	---------	---	-------------------------------

**81869** **350981869000**

**KW**

**PEUGEOT**
**Partner II, Tepee**

1.6 HDi 16V 4x4	66	04/12 →	D	9HS (DV6TED4BU), 9HX (DV6ATED4)
-----------------	----	---------	---	---------------------------------

1.6 HDi 90	68	04/10 →	D	9HP (DV6DTED)
------------	----	---------	---	---------------

1.6 HDi 90	68	04/10 →	D	9HP (DV6DTED), 9HX (DV6ATED4)
------------	----	---------	---	-------------------------------

**SUZUKI**
**SX4**

1.6 DDIS	66	04/07 →	D	9HX
----------	----	---------	---	-----

**VOLVO**

C 30 1.6 D	80	10/06 → 12/12	D	D4164T
------------	----	---------------	---	--------

1.6 D2	84	10/10 → 12/12	D	D4162T
--------	----	---------------	---	--------

**S 40 II**

1.6 D	81	01/05 →	D	D4164T
-------	----	---------	---	--------

1.6 D2	84	10/10 →	D	D4162T
--------	----	---------	---	--------

**S 60 II**

DRIVE / D2	84	01/11 →	D	D4162T
------------	----	---------	---	--------

**S 80 II**

1.6 D DRIVE	80	01/10 →	D	D4164T
-------------	----	---------	---	--------

1.6 DRIVE	84	06/11 →	D	D4162T
-----------	----	---------	---	--------

**V 40 II**

D2	84	03/12 →	D	D4162T
----	----	---------	---	--------

**V 50**

1.6 D	81	01/05 →	D	D4164T
-------	----	---------	---	--------

1.6 D2	84	01/10 →	D	D4162T
--------	----	---------	---	--------

**V 60**

1.6 DRIVE	84	06/11 →	D	D4162T
-----------	----	---------	---	--------

**V 70 III**

1.6 D	80	01/10 →	D	D4164T
-------	----	---------	---	--------

1.6 DRIVE / D2	84	06/11 →	D	D4162T
----------------	----	---------	---	--------

81872

350981872000

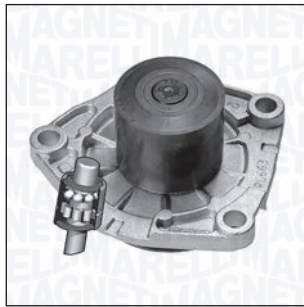

**PULEGGIA**

Diametro Puleggia	Ø48
Altezza Puleggia	37
Posizione Attacco	44.5
Diametro Girante	Ø75.9
N° Alette Girante	8
Posizione Girante	17.5



**ALFA ROMEO**

**147**

1.9 JTD 16V	93	09/03 → 09/04	D	937A4.000
	100	10/04 → 03/10	D	192B1.000
1.9 JTDM 16V	103	11/02 → 03/10	D	192A5.000
	110	09/04 → 03/10	D	937A5.000
	125	06/08 → 03/10	D	937A6.000

**156, Sportwagon**

1.9 JTD	93	11/03 → 09/05	D	937A4.000
	100	11/02 → 11/04	D	192B1.000
	110	07/04 → 09/05	D	937A5.000
1.9 JTD 16V	103	11/02 → 09/05	D	192A5.000
1.9 JTD 16V Q4	110	07/04 → 05/06	D	937A5.000
2.4 JTD	120	06/03 → 09/05	D	841M.000, 841N.000
	129	10/03 → 09/05	D	841G.000

**159, Sportwagon**

1.9 JTDM 16V	100	03/06 → 11/11	D	937A8.000
	100	09/05 → 11/11	D	937A8.000, 939A8.000
	110	09/05 → 11/11	D	939A2.000
2.0 JTDM	100	06/10 → 11/11	D	939B4.000
	120	05/09 → 11/11	D	844A2.000
2.4 JTDM	125	05/09 → 11/11	D	939B3.000
	147	09/05 → 11/11	D	939A3.000
2.4 JTDM Q4	154	05/07 → 11/11	D	939A9.000
	154	05/07 → 11/11	D	939A9.000

**166**

2.4 JTD	120	10/03 → 06/07	D	841M.000, 841N.000
	129	10/03 → 06/07	D	841G.000, 841H.000
	132	07/06 → 06/07	D	841M.000
	136	07/05 → 06/07	D	841M.000, 936B.000

81872

350981872000



**ALFA ROMEO**

**Brera**

2.0 JTDM	120	03/08 → 06/10	D	844A2.000
	125	05/09 → 06/10	D	939B3.000
2.4 JTDM 20V	147	01/06 → 06/10	D	939A3.000
	154	05/07 → 06/10	D	939A9.000

**Giulietta III**

1.6 JTDM	77	04/10 →	D	940A3.000
	100	04/10 →	D	940A8.000, 940B6.000
		103	04/10 →	D
2.0 JTDM	110	08/13 →	D	940B5.000
	120	04/10 →	D	940A7.000
	125	04/10 →	D	940A4.000
	129	11/13 →	D	940B4.000

**GT II**

1.9 JTD	110	11/03 → 09/10	D	937A5.000
	125	05/08 → 09/10	D	937A6.000

**Mito**

1.6 JTDM	85	09/08 →	D	955A4.000
	88	09/08 →	D	198A2.000, 955A3.000

**Spider V**

2.0 JTDM	120	04/09 → 06/10	D	844A2.000
	125	05/09 → 06/10	D	939B3.000
2.4 JTDM	147	04/07 → 06/10	D	939A3.000
	154	03/08 → 06/10	D	939A3.000

**CADILLAC**

**BLS, Station Wagon**

1.9 D	110	04/06 →	D	Z19DTH
	132	12/07 →	D	Z19DTR

**CHEVROLET**

**Malibu**

2.0 D	118	04/12 →	D	LBS
-------	-----	---------	---	-----

**CHRYSLER**

**Delta**

1.6 D Multijet	88	08/11 →	D	198A2.000
2.0 D Multijet	121	08/11 →	D	198A5.000

**FIAT**

**500L**

1.6 D Multijet	77	09/12 →	D	199B5.000
	88	09/13 →	D	940C1.000, 955A3.000

**500X**

1.6 D Multijet	84	09/14 →	D	55260384
	88	09/14 →	D	55260384

**81872** **350981872000**

**FIAT**
**Bravo II, Van**

1.6 D Multijet	66	03/08 →	D	198A6.000
	77	03/08 →	D	198A3.000
	77	09/07 →	D	198A3.000, 844A3.000
	85	11/08 →	D	955A4.000
	88	03/08 →	D	198A2.000
1.9 D Multijet	110	04/07 →	D	937A5.000
2.0 D Multijet	120	09/08 →	D	198A8.000, 844A2.000
	121	09/08 →	D	198A5.000

**Croma II**

1.9 D Multijet	100	12/05 →	D	939A8.000
	110	06/05 →	D	939A2.000
2.4 D Multijet	147	06/05 →	D	939A3.000

**Doblò II, Cargo**

1.6 D Multijet	66	02/10 →	D	263A4.000
	66	02/10 →	D	263A4.000, 263A5.000
	74	02/10 →	D	263A3.000
	77	02/10 →	D	198A3.000
2.0 D Multijet	99	02/10 →	D	263A1.000

**Ducato V**

115 Multijet 2,0 D	85	06/11 →	D	250A1.000, 250A2.000
120 Multijet 2,3 D 4x4	88	03/10 →	D	F1AE0481D

**Freemont**

2.0 JTD	100	08/11 →	D	939B5.000
	103	08/11 →	D	939B5.000, 940A5.000
	120	08/11 →	D	939B5.000
	125	08/11 →	D	939B5.000
2.0 JTD 4x4	120	08/11 →	D	939B5.000
	125	08/11 →	D	939B5.000

**Grande Punto, Van**

1.6 D Multijet	88	07/08 →	D	955A3.000
1.9 D Multijet	85	06/06 →	D	939A7.000

**Idea**

1.6 D Multijet	88	05/08 →	D	350A2.000
----------------	----	---------	---	-----------

**Linea**

1.6 D Multijet	77	06/09 →	D	198A3.000
----------------	----	---------	---	-----------

**Punto Evo, Van**

1.6 D Multijet	88	10/09 → 02/12	D	955A3.000
----------------	----	---------------	---	-----------

**81872** **350981872000**

**FIAT**
**Sedici**

2.0 D Multijet	99	06/06 →	D	D20AA
2.0 D Multijet 4x4	99	06/06 →	D	D20AA

**Stilo, Station Wagon**

1.9 D Multijet	110	09/05 → 11/06	D	937A5.000
1.9 JTD	93	09/03 → 11/06	D	937A4.000
	100	04/04 → 11/06	D	192B1.000
	103	01/04 → 11/06	D	192A5.000

**JEEP**
**Renegade**

1.6 CRD	88	07/14 →	D	EJK
2.0 CRD 4x4	88	07/14 →	D	EBT
	103	07/14 →	D	EBT
	125	07/14 →	D	EBT

**LANCIA**
**Delta III**

1.6 D Multijet	77	04/11 → 08/14	D	944A3.000
	85	08/08 → 08/14	D	955A4.000
	88	09/08 → 08/14	D	198A2.000
1.9 D Multijet	140	01/09 → 08/14	D	844A1.000
2.0 D Multijet	120	09/08 → 08/14	D	844A2.000
	121	09/08 → 08/14	D	198A5.000, 198A8.000

**Musa**

1.6 D Multijet	85	07/08 → 09/12	D	350A2.000, 350A3.000
	88	07/08 → 09/12	D	350A2.000

**Thesis**

2.4 D Multijet	136	04/06 → 07/09	D	841P.000
2.4 JTD	120	09/03 → 07/09	D	841M.000, 841N.000
	129	05/03 → 07/09	D	841G.000

**OPEL**
**Astra H, Station Wagon, GTC, Twin Top, Van**

1.9 CDTI	110	09/04 →	D	Z19DTH
1.9 CDTI 16V	88	04/04 →	D	Z19DTJ

**Astra J, Station Wagon, GTC**

2.0 BiTurbo CDTI	143	12/12 →	D	A20DTR
2.0 CDTI	96	10/10 →	D	
	118	12/09 →	D	A20DTH
	121	10/11 →	D	A20DTH

81872 350981872000



**OPEL**

**Cascada (W13)**

2.0 CDTI	121	03/13 →	D	A20DTH
	143	03/13 →	D	A20DTR

**Combo C**

1.6 CDTI	66	02/12 →	D	A16FDL
	74	02/12 →	D	A16FDH
	77	02/12 →	D	A16FDH
2.0 CDTI	99	02/12 →	D	A20FD

**Insignia, Station Wagon**

2.0 Biturbo CDTI	140	07/08 →	D	A20DTR
	143	01/12 →	D	A20DTR
2.0 Biturbo CDTI 4x4	140	05/09 →	D	A20DTR
	143	01/12 →	D	A20DTR

2.0 CDTI	81	07/08 →	D	A20DTC, A20DTL
	88	03/12 →	D	A20DTE
	96	07/08 →	D	A20DT, A20DTJ
	103	07/13 →	D	A20DTE
	118	07/08 →	D	A20DTH
	120	07/13 →	D	A20DTH
	125	11/14 →	D	B20DTH
2.0 CDTI 4x4	118	06/10 →	D	A20DTH
	120	07/13 →	D	A20DTH

**Signum**

1.9 CDTI	110	04/04 →	D	Z19DTH
----------	-----	---------	---	--------

**Vectra C, Station Wagon**

1.9 CDTI	110	04/04 →	D	Z19DTH
----------	-----	---------	---	--------

**Zafira B, Van**

1.9 CDTI	110	07/05 →	D	Z19DTH
----------	-----	---------	---	--------

**Zafira C**

2.0 BiTurbo CDTI	143	01/13 →	D	A20DTR
2.0 CDTi	81	10/11 →	D	A20DTL
	96	10/11 →	D	A20DT, Y20DTJ, Z20DTJ
	118	10/11 →	D	A20DTH
	121	10/11 →	D	A20DTH

**SAAB**

**9-3 II, Station Wagon, Cabrio**

1.9 TiD	110	09/04 →	D	Z19DTH
1.9 TTiD	132	12/07 →	D	A19DTR, Z19DTR
	132	12/07 →	D	Z19DTR

81872 350981872000



**SAAB**

**9-3 X**

1.9 TTiD	132	02/09 →	D	A19DTR, Z19DTR
----------	-----	---------	---	----------------

**9-5 I, Station Wagon**

1.9 TiD	110	01/06 → 12/09	D	Z19DTH
---------	-----	---------------	---	--------

**9-5 II, Station Wagon**

2.0 TiD	118	05/10 → 01/12	D	A20DTH
2.0 TTiD	140	05/10 → 01/12	D	A20DTR
2.0 TTiD XWD	140	05/10 → 01/12	D	A20DTR

**SUZUKI**

**SX4**

2.0 DDiS	99	07/09 →	D	D20AA
2.0 DDiS 4x4	99	07/09 →	D	D20AA

**VAUXHALL**

**ASTRA**

2.0 CDTI	118	12/09 →	D	A20DTH
----------	-----	---------	---	--------

81999 350981999000



<b>FLANGIA</b>	
Numero Fori Flangia	3
Dimensione Fori Flangia	M8x1.25
Posizione Attacco	85
Diametro Mozzo	Ø23
Diametro Centraggio	Ø26
Diametro Girante	Ø65
N° Alette Girante	7
Posizione Girante	49.3



**LADA**

**Niva I**

1600	54	01/87 → 03/95	B	BA32121
1700 i	59	06/96 →	B	BA32124
1700 i 4x4	60	10/00 →	B	BA32124

**Nova**

1300	48	09/85 → 12/91	B	BA32105
	49	08/94 →	B	BA32103
1500	55	09/85 → 02/93	B	BA32103
	56	01/88 → 10/01	B	BA32106
1700	62	08/94 →	B	B032123
1700 i Classic	62	06/96 →	B	B032123

**Toscana**

1500	55	09/83 → 02/93	B	BA32103
------	----	---------------	---	---------



**82001**
**350982001000**

**FLANGIA**

Numero Fori Flangia	3
Dimensione Fori Flangia	M8x1.25
Posizione Attacco	66
Diametro Mozzo	Ø40
Diametro Girante	Ø59
N° Alette Girante	6
Posizione Girante	29.5

**KW**

**VOLKSWAGEN**
**Transporter III**

1.6 TD	51	08/84 → 07/92	D	JX	(+)COP, → M: 012.052
1.6 TD Syncro	51	03/86 → 07/92	D	JX	(+)COP, → M: 012.052

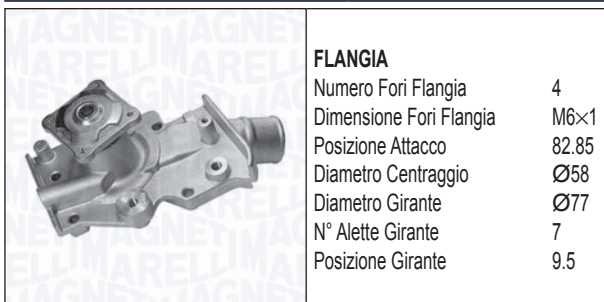
**82004**
**350982004000**

**FLANGIA**

Numero Fori Flangia	4
Dimensione Fori Flangia	M6x1
Posizione Attacco	82.85
Diametro Centraggio	Ø58
Diametro Girante	Ø77
N° Alette Girante	7
Posizione Girante	9.5

**KW**

**FORD**
**Mondeo I, Station Wagon**

1.6 i 16V	65	07/94 → 08/96	B	L1J	
	66	02/93 → 08/96	B	L1F	
1.8 4x4	85	02/93 → 08/96	B	RKA	
	82	07/94 → 08/96	B	RKB	
1.8 i 16V	85	02/93 → 08/96	B	RKA	
	85	02/93 → 08/96	B	RKA	
2.0 i 16V	97	12/94 → 08/96	B	NGA	
	100	02/93 → 08/96	B	NGA	02-1993 →
	100	04/93 → 08/96	B	NGA	
2.0 i 16V 4x4	97	12/94 → 08/96	B	NGA	
	100	04/93 → 08/96	B	NGA	

**Mondeo II, Station Wagon**

1.6 i	66	08/96 → 09/00	B	L1J	
1.6 i 16V	70	05/98 → 09/00	B	L1L, L1N, L1Q	

**82004**
**350982004000**

**KW**

**OPEL**
**Mondeo II, Station Wagon**

1.8 i	85	08/96 → 09/00	B	RKB, RKF, RKH, RKJ, RKK	→ 04-1998
	85	08/96 → 09/00	B	RKB, RKF, RKH, RKJ, RKK	
2.0 i	96	08/96 → 09/00	B	NGA, NGB, NGC, NGD	

**82005**
**350982005000**

**PULEGGIA**

Diametro Puleggia	Ø57.2
Numero Denti/Gole Puleggia	23
Altezza Puleggia	19.5
Posizione Attacco	61.3
Diametro Girante	Ø55
N° Alette Girante	9
Posizione Girante	35

**KW**

**OPEL**
**Astra F Classic**

1.6 i 16V	74	01/98 → 08/02	B	X16XEL	
1.4 i 16V	66	02/96 → 09/98	B	X14XE	
	74	08/94 → 09/98	B	X16XEL	

**Astra G, Station Wagon, Coupé, Cabrio, Van**

1.4 16V	66	02/98 → 01/05	B	X14XE, Z14XE	→ 08-2000, → M: 20U75998, → M: 02MV7224, → M: 20U75998
	66	09/98 → 01/05	B	X14XE, Z14XE	
1.6 16V	74	02/98 → 01/05	B	C16SEL, X16XEL, Z16XE	→ M: 02MV7224, → M: 20U75998
	74	02/98 → 07/04	B	X16XEL, Z16XE	→ M: 02MV7224, → M: 20U75998
	74	09/98 → 01/05	B	X16XEL, Z16XE	
	74	03/01 → 10/05	B	Z16XE	→ M: 02MV7224, → M: 20U75998
1.6 LPG	74	03/00 → 05/05	B	Z16XE	
	74	06/02 → 01/05		Z16XE	

**82005**
**350982005000**

**KW**

**OPEL**
**Combo A**

1.4 16V 66 08/99 → 10/01 B X14XE

**Corsa B, Station Wagon, Van**

1.4 i 16V 63 08/97 → 09/00 B C14SEL

1.4 i 16V 66 09/94 → 09/00 B X14XE

1.4 i 16V 67 09/94 → 09/00 B X14XE

1.6 GSI 16V 80 03/93 → 09/00 B C16XE

1.6 i 16V 74 08/97 → 09/00 B C16SEL

1.6 i 16V 78 09/94 → 09/00 B X16XE

**Tigra I**

1.4 16V 63 08/97 → 12/00 B X14XE

1.4 16V 66 07/94 → 12/00 B X14XE

1.6 16V 74 08/97 → 08/98 B C16SEL

1.6 16V 78 07/94 → 08/98 B X16XE

**Vectra B, Station Wagon**

1.6 16V 74 10/95 → 04/02 B X16XEL, Y16XE, Z16XE → M: 20U75998, → M: 02MV7224

1.6 i 16V 74 10/95 → 07/02 B X16XEL, Y16XE, Z16XE → M: 02MZ5253

1.6 i 16V 74 11/96 → 07/02 B X16XEL, Y16XE, Z16XE → M: 20U75998, → M: 02MZ5253

**Zafira A**

1.6 16V 74 04/99 → 06/05 B X16XEL, Z16XE → 06-2000, → M: 02MV7224, → M: 20U75998, → M: 02MV7224

**82010**
**350982010000**

**FLANGIA**

 Posizione Attacco 56.5  
 Diametro Centraggio Ø28  
 Diametro Girante Ø60  
 N° Alette Girante 6  
 Posizione Girante 10

**KW**

**BMW**
**1 I (E81, E87), Coupé (E82), Cabrio (E88)**

116 i 85 11/03 → 09/12 B N43B16A, N45B16A

116 i 85 03/07 → 09/12 B N45B16A

116 i 90 03/07 → 09/12 B N43B16A, N45B16A

118 i 95 07/04 → 09/12 B N43B20A, N46B20B

118 i 100 07/04 → 09/12 B N43B20A, N46B20B M: N46NB20B

118 i 100 09/08 → 12/13 B N46B20B

118 i 105 03/08 → 12/13 B N43B20A

118 i 105 09/06 → 09/12 B N43B20A, N46B20B

120 i 110 11/03 → 09/12 B N46B20B, N46B20BD, N46B20C, N46B20CC, N46B20CD

120 i 115 11/03 → 09/12 B N46B20A, N46B20B, N46B20BD, N46B20C, N46B20CC, N46B20CD

120 i 115 09/09 → 10/13 B N46B20B

120 i 115 09/06 → 09/12 B N46B20B, N46B20C

120 i 115 03/08 → 12/13 B N46B20B, N46B20C, N46B20E

120 i 125 03/08 → 12/13 B N43B20A

125 125 02/07 → 09/12 B N43B20A, N46B20B, N46B20BD, N46B20C, N46B20CC, N46B20CD

125 125 09/06 → 09/12 B N43B20A, N46B20B, N46B20C

**82010 350982010000**

**BMW**
**3 IV (E46), Touring, Cabrio, Coupé, Compact**

316 Ci	77	04/00 → 07/06	B	M43B16 (164E3)	06-2001 →
	85	06/02 → 07/06	B	N45B16A	
316 i	77	04/00 → 02/05	B	M43B16, M43B16 (164E3)	06-2002 →
	85	06/02 → 02/05	B	N40B16A, N45B16A	
	85	06/02 → 02/05	B	N45B16, N45B16A	
	85	02/02 → 02/05	B	N42B18A, N46B18, N46B18A	
316 ti	85	06/02 → 02/05	B	N40B16A, N45B16A	
	85	06/01 → 02/05	B	N42B18A, N46B18A	
318 Ci	105	09/01 → 12/07	B	N42B20A, N46B20A	
	110	03/05 → 07/06	B	N46B20A	
	110	02/05 → 12/07	B	N46B20A, N46B20B	
318 i	105	09/01 → 02/05	B	N42B20A, N46B20, N46B20A	
318 ti	105	09/01 → 02/05	B	N42B20A, N46B20A	

**3 V (E90), Touring (E91), Cabrio (E93), Coupé (E92)**

316 i	85	02/06 → 12/11	B	N45B16, N45B16A, N45B16TU2	
318 i	95	09/05 → 03/07	B	N46B20, N46B20B	
	100	06/07 → 12/11	B	N46B20B, N46B20E	

**82010 350982010000**

**BMW**
**3 V (E90), Touring (E91), Cabrio (E93), Coupé (E92)**

320 i	110	03/07 → 08/07	B	N46B20, N46B20A		
	110	01/05 → 03/07	B	N46B20, N46B20A, N46B20B, N46B20C		
	110	09/05 → 06/12	B	N46B20, N46B20A, N46B20C		
	110	11/06 → 06/07	B	N46B20A		
	115	03/07 → 12/13	B	N46B20B		
	115	03/07 → 12/11	B	N46B20B, N46B20C, N46B20CC, N46B20CD, N46B20E		
	125	03/07 → 12/13	B	N43B20A		
	320 si	127	05/06 → 12/11	B	N45B20A	

**5 V (E60), Touring (E61)**

520 i	115	04/06 → 12/09	B	N46B20B	
	125	09/07 → 03/10	B	N43B20A	

**X1 I (E84)**

sDrive 18 i	100	03/09 → 06/15	B	N46B20B	
	110	01/10 → 06/15	B	N46B20B	

**X3 I (E83)**

2.0 i	110	07/05 → 08/08	B	N46B20, N46B20B	
xDrive 20 i	110	09/08 → 08/11	B	N46B20B	

**Z4 I (E85), Coupé (E86)**

2.0 i	110	03/05 → 02/09	B	N46B20, N46B20A, N46B20B	
-------	-----	---------------	---	--------------------------------	--

82011

350982011000



**FLANGIA**

Numero Fori Flangia	3
Dimensione Fori Flangia	M8x1.25
Posizione Attacco	55
Diametro Mozzo	Ø30
Diametro Girante	Ø49
N° Alette Girante	8
Posizione Girante	15.5



**OPEL**

**Agila A**

1.0	44	08/03 → 12/07	B	Z10XEP
1.2 16V Twinport	59	07/04 → 12/07	B	Z12XEP

**Astra G, Station Wagon, Coupé, Cabrio, Van**

1.4	66	09/07 → 12/09	B	Z14XEP
-----	----	---------------	---	--------

**Astra H, Station Wagon, GTC, Twin Top, Van**

1.2	59	08/05 →	B	Z12XEP
1.4	55	04/04 → 10/04	B	Z14XEL
	59	04/04 → 10/04	B	Z14XEL
	66	03/04 →	B	Z14XEP
1.4 LPG	66	08/09 →		Z14XEP

**Combo B**

1.4 16V	66	08/05 →	B	Z14XEP
---------	----	---------	---	--------

**Corsa C, Van**

1.0	44	06/03 → 12/09	B	Z10XEP
1.2	59	07/05 →	B	Z12XEP
1.2 Twinport	59	07/04 → 12/09	B	Z12XEP
1.4	66	08/03 →	B	Z14XEP
1.4 Twinport	66	06/03 → 12/09	B	Z14XEP

**Corsa D, Van**

1.0	44	07/06 →	B	A10XEP
	44	07/06 →	B	Z10XEP
	48	01/10 →	B	A10XEP
1.2	59	07/06 →	B	Z12XEP
1.2 LPG	55	09/09 →		Z12XEP
	59	09/09 →		Z12XEP
1.4	66	07/06 →	B	Z14XEP
1.4 LPG	66	07/06 →		Z14XEP

**Meriva A**

1.4 16V Twinport	66	07/04 → 05/10	B	Z14XEP
1.4 16V Twinport LPG	66	07/04 → 05/10		Z14XEP

**Tigra II Twin Top**

1.4	66	06/04 →	B	Z14XEP
-----	----	---------	---	--------

82011

350982011000



**VAUXHALL**

**ASTRA**

1.4	66	01/04 → 05/09	B	Z14XEP
-----	----	---------------	---	--------

82012

350982012000



**PULEGGIA**

Diametro Puleggia	Ø90
Altezza Puleggia	27
Posizione Attacco	57
Diametro Girante	Ø60
N° Alette Girante	6
Posizione Girante	25.5



**TOYOTA**

**Auris I, Van**

1.4 VVTi	71	03/07 → 09/12	B	4ZZ-FE
----------	----	---------------	---	--------

**Avensis I, Liftback, Station Wagon**

1.6 VVT-i	81	10/00 → 02/03	B	3ZZ-FE
1.8 VVT-i	95	10/00 → 02/03	B	1ZZ-FE

**Avensis II, Liftback, Station Wagon**

1.6 VVT-i	81	04/03 → 11/08	B	3ZZ-FE
1.8	95	04/03 → 11/08	B	1ZZ-FE

**Celica VII**

1.8 16V VT-i	105	08/99 → 07/05	B	1ZZ-FE
--------------	-----	---------------	---	--------

**Corolla Verso**

1.6	81	04/04 → 03/09	B	3ZZ-FE
1.8	95	04/04 → 03/09	B	1ZZ-FE

**Corolla VI, Liftback, Station Wagon, Compact**

1.4	71	02/00 → 01/02	B	4ZZ-FE	11-2001 →
	71	02/00 → 01/02	B	4ZZ-FE	
1.4 16V	71	02/00 → 11/01	B	4ZZ-FE	11-2001 →
1.6	81	02/00 → 01/02	B	3ZZ-FE	
1.6 16V	81	02/00 → 11/01	B	3ZZ-FE	

**Corolla VII, Liftback, Station Wagon, Verso**

1.4 VVT-i	71	01/02 → 12/06	B	4ZZ-FE
1.6 VVT-i	81	01/02 → 12/06	B	3ZZ-FE
	92	05/02 → 05/04	B	1ZZ-FE
	96	03/01 → 07/05	B	1ZZ-FE
1.8	100	06/04 → 02/07	B	1ZZ-FE
	100	06/04 → 02/07	B	1ZZ-FE
1.8 4WD	100	12/01 → 02/07	B	1ZZ-FE
1.8 4x4	94	06/07 → 07/07	B	1ZZ-FE
1.8 VVTi	100	06/04 → 02/07	B	1ZZ-FE
1.8 VVT-i	99	01/02 → 05/04	B	1ZZ-FE

**82012 350982012000**

**TOYOTA**
**Corolla VIII, Hatchback, Station Wagon**

1.4 VVT-i 71 01/07 → B 4ZZ-FE

**MR 2 III**

1.8 16V VVT-i 103 10/99 → 06/07 B 1ZZ-FE

**RAV 4 II**

1.8 VVTi 92 08/00 → 11/05 B 1ZZ-FE

**82013 350982013000**

**PULEGGIA**

 Diametro Puleggia Ø56  
 Numero Denti/Gole Puleggia 19  
 Altezza Puleggia 33.5  
 Posizione Attacco 52  
 Diametro Girante Ø59.5  
 N° Alette Girante 8  
 Posizione Girante 48

**SEAT**
**Cordoba III, Vario**

1.9 SDI 47 09/02 → 11/09 D ASY

**SKODA**
**Fabia I, Station Wagon, Van**

1.9 SDI 47 12/99 → 03/08 D ASY T→: 6Y3X628013

**VOLKSWAGEN**
**Polo V (9N)**

 1.9 SDI 47 10/01 → 11/09 D ASY T→: 9N210001  
 47 09/02 → D ASY

**82014 350982014000**

**FLANGIA**

 Numero Fori Flangia 3  
 Dimensione Fori Flangia M6×1  
 Posizione Attacco 61  
 Diametro Girante Ø56  
 N° Alette Girante 6  
 Posizione Girante 13.3

**NISSAN**
**Micra III (K12), C+C**

1.0 16V 48 01/03 → 06/10 B CG10DE

48 01/03 → 06/10 B CG12DE, CR12DE

1.2 16V 59 01/03 → 06/10 B CG12DE, CR12DE

1.4 16V 65 08/05 → B CR14DE

160 SR 81 05/05 → 06/10 B HR16DE

**Note I**

1.4 65 03/06 → B CR14DE

**82015 350982015000**

**FLANGIA**

 Numero Fori Flangia 3  
 Dimensione Fori Flangia M8×1.25  
 Posizione Attacco 55.5  
 Diametro Mozzo Ø30  
 Diametro Girante Ø66  
 N° Alette Girante 7  
 Posizione Girante 16.5

**AUDI**
**A4 II, Avant, Cabriolet**

2.7 TDI 132 06/06 → 03/09 D BPP

3.0 TDI 150 01/06 → 03/09 D BKN

quattro 171 01/06 → 03/09 D ASB

3.2 FSI 188 01/06 → 03/09 B AUK

3.2 FSI quattro 188 01/06 → 03/09 B AUK

**A4 III, Avant**

2.7 TDI 120 11/05 → 06/08 D BSG

132 01/06 → 06/08 D BPP

3.0 TDI 150 11/04 → 06/08 D BKN

quattro 171 01/06 → 06/08 D ASB

3.2 FSI 188 01/05 → 06/08 B AUK

**82015**
**350982015000**

**KW**

**AUDI**
**A4 III, Avant**

3.2 FSI quattro	188	01/05 → 06/08	B	AUK
	188	01/05 → 06/08	B	AUK, BKH

**A4 IV, Avant, Allroad**

2.7 TDI	120	11/07 → 03/12	D	CAMB, CGKB
	140	11/07 → 03/12	D	CAMA, CGKA
3.0 TDI quattro	155	06/08 → 05/10	D	CCWB
	176	11/07 → 03/12	D	CAPA, CCLA, CCWA
	176	04/09 →	D	CCWA
S4 quattro	245	11/08 → 12/15	B	CAKA, CCBA, CGWC, CGXC, CREC, CTUB

**A5, Sportback, Cabriolet**

2.7 TDI	120	09/07 →	D	CAMB, CGKB
	120	05/09 →	D	CGKB
	140	06/07 →	D	CAMA, CGKA
	140	03/09 →	D	CGKA
3.0 TDI quattro	155	03/08 →	D	CCWB
	176	06/07 →	D	CAPA, CCWA
	176	03/09 →	D	CCWA
S5 quattro	245	06/09 →	B	CAKA, CCBA, CGWC, CGXC, CREC, CTDA, CTUB
	245	10/11 →	B	CAKA, CGWC, CGXC, CREC, CTDA, CTUB

**A6 III, Avant, Allroad**

2.4	130	05/04 → 10/08	B	BDW
2.4 quattro	130	01/05 → 10/08	B	BDW
2.7 TDI	120	11/04 → 03/11	D	BSG, CANB
	132	11/04 → 10/08	D	BPP
2.7 TDI quattro	140	10/08 → 03/11	D	CANA
	120	06/05 → 03/11	D	BSG, CAND
	132	11/04 → 10/08	D	BPP
	140	10/08 → 03/11	D	CANC
3.0 TDI	171	06/06 → 03/11	D	ASB
3.0 TDI quattro	155	05/04 → 03/11	D	BNG, CDYB
	165	05/04 → 05/06	D	BMK
	171	06/06 → 10/08	D	ASB
	176	10/08 → 03/11	D	CDYA, CDYC
3.0 TFSI quattro	213	10/08 → 03/11	B	CAJA → 02-2009
	213	10/08 → 08/11	B	CAJA
	220	10/08 → 03/11	B	CCAA

**82015**
**350982015000**

**KW**

**AUDI**
**A6 III, Avant, Allroad**

3.2 FSI	188	03/05 → 10/08	B	AUK
	188	05/04 → 05/09	B	AUK, BKH
	195	05/09 → 03/11	B	CALA
3.2 FSI quattro	183	09/06 → 10/08	B	BYU
	188	05/06 → 10/08	B	AUK
	188	05/04 → 10/08	B	AUK, BKH

**A8 II**

3.0 TDI quattro	155	11/03 → 07/10	D	BNG
	171	08/03 → 07/10	D	ASB
3.2 FSI	191	06/05 → 07/10	B	BPK
3.2 FSI quattro	191	06/05 → 07/10	B	BPK

**Q5**

3.0 TDI quattro	155	11/08 →	D	CCWB
	176	11/08 →	D	CCWA, CPNB

**Q7 I**

3.0 TDI	155	03/06 → 05/10	D	BUN, CASB
	165	06/09 → 05/12	D	CATA
	171	03/06 → 05/08	D	BUG
	176	11/07 → 08/15	D	CASA, CCMA, CJGA, CNRB
3.0 TFSI	200	05/10 → 08/15	B	CJTC, CJWC
	206	05/11 → 08/15	B	CJWE, CTWB
	245	05/10 → 08/15	B	CJTB, CJWB, CNA, CTWA

**VOLKSWAGEN**
**Phaeton**

3.0 V6 TDI 4motion	165	09/04 →	D	BMK
	171	06/07 →	D	CARA
	176	11/08 →	D	CARB, CEXA

**Touareg I**

3.0 TDI	155	04/06 → 05/10	D	BUN, CASB
3.0 V6 TDI	165	11/04 → 05/10	D	BKS, CATA
	176	11/07 → 05/10	D	CASA, CASC

**Touareg II**

3.0 V6 TDI	165	06/10 →	D	CATA
	176	01/10 →	D	CASA, CNRB

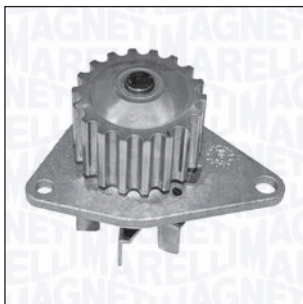
**82016**
**350982016000**

**PULEGGIA**

Diametro Puleggia	Ø53.25
Numero Denti/Gole Puleggia	18
Altezza Puleggia	30
Posizione Attacco	41.5
Diametro Girante	Ø53.6
N° Alette Girante	6
Posizione Girante	40.6

**KW**

**CITROËN**
**C 2, Van**

1.4 16V	65	06/06 →	B	KFU (ET3J4)
---------	----	---------	---	-------------

**C 3 I, Pluriel**

1.4 16V	65	12/03 →	B	KFU (ET3J4)
---------	----	---------	---	-------------

**C 4 I, Coupé, Picasso, Grand Picasso**

1.4 16V	65	11/04 → 07/11	B	KFU (ET3J4)
---------	----	---------------	---	-------------

**PEUGEOT**
**205 II, Van**

1.4 16V	65	10/03 →	B	KFU (ET3J4)
---------	----	---------	---	-------------

**206, CC, Van**

1.4 16V	65	10/03 →	B	KFU (ET3J4)
---------	----	---------	---	-------------

**207, Station Wagon, CC, Van**

	65	02/06 →	B	KFU (ET3J4)
--	----	---------	---	-------------

1.4 16V	70	06/07 →	B	8FS (EP3), EP3, EP3C
---------	----	---------	---	----------------------

**307, Station Wagon, CC**

1.4 16V	65	11/03 →	B	KFU (ET3J4)
---------	----	---------	---	-------------

**82017**
**350982017000**

**FLANGIA**

Numero Fori Flangia	4
Dimensione Fori Flangia	M6×1
Posizione Attacco	61.5
Diametro Mozzo	Ø22
Diametro Girante	Ø58
N° Alette Girante	6
Posizione Girante	14

**KW**

**MERCEDES-BENZ**
**Classe A II (W169)**

A 150	70	09/04 → 06/12	B	M266.920
A 160	70	04/09 → 06/12	B	M266.920
A 160 CDI	60	09/04 → 06/12	D	OM640.942
A 170	85	09/04 → 06/12	B	M266.940
A 180	85	04/09 → 06/12	B	M266.940

**82017**
**350982017000**

**KW**

**MERCEDES-BENZ**
**Classe A II (W169)**

A 180 CDI	80	09/04 → 06/12	D	OM640.940
A 200	100	09/04 → 06/12	B	M266.960
A 200 CDI	100	09/04 → 06/12	D	OM640.941
	103	09/04 → 06/12	D	OM640.941

A 200 TURBO	142	09/05 → 06/12	B	M266.980
-------------	-----	---------------	---	----------

**Classe B I (W245)**

B 150	70	03/05 → 11/11	B	M266.920
B 160	70	04/09 → 11/11	B	M266.920
B 170	85	03/05 → 11/11	B	M266.940
B 170 NGT	85	04/08 → 11/11		M266.960
B 180	85	04/09 → 11/11	B	M266.940
B 180 CDI	80	03/05 → 11/11	D	OM640.940
B 180 NGT	85	04/08 → 11/11		M266.960
B 200	100	03/05 → 11/11	B	M266.960
B 200 CDI	100	03/05 → 11/11	D	OM640.941
	103	03/05 → 11/11	D	OM640.941
B 200 TURBO	142	03/05 → 11/11	B	M266.980

**MITSUBISHI**
**Colt VI**

1.5 DI-D	50	08/04 → 06/12	D	OM639.939
	70	08/04 → 06/12	D	OM639.939

**SMART**
**ForFour I**

1.5 CDI	50	09/04 → 06/06	D	OM639.939
	70	09/04 → 06/06	D	OM639.939

**82018**
**350982018000**

**FLANGIA**  
 Numero Fori Flangia 3  
 Dimensione Fori Flangia M6×1  
 Posizione Attacco 43.7  
 Diametro Centraggio Ø23.3  
 Diametro Girante Ø49.6  
 N° Alette Girante 6  
 Posizione Girante 81

**FORD**
**Fiesta V, Van**

1.3	44	11/01 → 06/08	B	BAJA	
	51	11/01 → 06/08	B	A9JA, A9JB	

**KA I, StreetKa, Van**

1.3 i	44	09/96 → 11/08	B	BAA, J4D, J4K, J4M, J4N, J4P, J4S	M: DU13BAYA, M: DU13BAA
	44	05/02 → 05/05	B	BAA, J4D, J4K, J4M, J4N, J4P, J4S	
1.6	51	08/02 → 11/08	B	A9A, A9B	
	70	09/00 → 11/08	B	CDB, CDC	
1.6 i	70	05/03 → 07/05	B	CDRA, CDRB	
	71	11/05 → 09/08	B		
1.6 i	70	07/03 → 11/08	B	CDB, CDC	

**82020**
**350982020000**

**FLANGIA**  
 Numero Fori Flangia 4  
 Dimensione Fori Flangia M6×1  
 Posizione Attacco 92.4  
 Diametro Centraggio Ø20  
 Diametro Girante Ø59.6  
 N° Alette Girante 6  
 Posizione Girante 4.9

**HYUNDAI**
**Accent I**

1.3	40	09/95 → 05/98	B	G4EH	
1.5 i 16V	73	12/95 → 01/00	B	G4ER	

**82020**
**350982020000**

**HYUNDAI**
**Accent II**

1.5	66	01/00 → 11/05	B	G4EB	
	75	09/00 → 11/05	B	G4EC-G	
	75	09/99 → 10/02	B	G4FK	
1.6	77	12/02 → 11/05	B	G4ED-G	

**Accent III**

1.4 GL	71	11/05 → 11/10	B	G4EE	
1.6 GLS	82	11/05 → 11/10	B	G4ED	

**Coupé I**

1.6 16V	77	03/02 → 08/09	B	G4ED-G	
	79	03/02 → 08/09	B	G4ED-G	

**Elantra I**

1.6	66	06/00 → 07/06	B	G4GR	
	77	05/03 → 07/06	B	G4ED-G	
	79	06/00 → 07/06	B	G4ED-G	
	82	09/03 → 07/06	B	G4GA	

**Getz**

1.1	49	09/05 → 06/09	B	G4HD, G4HG	
1.4 i	71	08/05 →	B	G4EE	
1.6	77	09/02 → 09/05	B	G4ED-G	
	78	08/05 →	B	G4ED-G	

**Matrix**

1.6	66	01/02 → 12/05	B	G4ED-L	
	76	06/01 → 08/10	B	G4ED-G	

**Tiburon**

1.6 CVVT	78	10/06 → 12/08	B	G4ED-G	
----------	----	---------------	---	--------	--

**KIA**
**Cerato I**

1.6	90	05/06 →	B	G4FC	
	77	07/04 →	B	G4ED	

**Pride I, Van**

1.6 CVVT LX	82	03/05 →	B	G4ED	
-------------	----	---------	---	------	--

**Rio II**

1.4 16V	71	03/05 →	B	G4EE	
1.6 16V	82	03/05 →	B	G4ED	
1.6 CVVT	82	03/05 →	B	G4ED	



**82021**
**350982021000**

**PULEGGIA**

Diametro Puleggia	Ø65
Altezza Puleggia	32.3
Posizione Attacco	59
Diametro Girante	Ø68.6
N° Alette Girante	6
Posizione Girante	18.9

**KW**

**HYUNDAI**
**Coupé I**

2.7 V6	121	01/07 → 08/09	B	G6BA-G
	123	03/02 → 08/09	B	G6BA-G

**Highway Van**

2.7 V6 24V	125	03/00 →	B	G6BA
------------	-----	---------	---	------

**Santa Fé I**

2.7 V6 4x4	127	02/01 → 03/06	B	G6BA-G
------------	-----	---------------	---	--------

**Sonata IV**

2.5 V6 24V	118	06/98 → 10/01	B	G6BV-G
2.7 V6	127	10/01 → 11/04	B	G6BA-G
	129	11/02 → 11/04	B	G6BA

**Trajet**

2.7 V6	127	09/00 → 07/08	B	G6BA-G
--------	-----	---------------	---	--------

**Tucson I**

2.7 Trazione integrale	129	08/04 → 03/10	B	G6BA-G
------------------------	-----	---------------	---	--------

**XG**

250	120	12/98 → 12/05	B	G6AV
-----	-----	---------------	---	------

**KIA**
**Magentis I**

2.5 V6	124	05/01 →	B	G6BV
--------	-----	---------	---	------

**Sportage II**

2.7 V6 4WD	129	09/04 →	B	G6BA
------------	-----	---------	---	------

**82022**
**350982022000**

**PULEGGIA**

Diametro Puleggia	Ø62
Altezza Puleggia	35
Posizione Attacco	58
Diametro Girante	Ø73
N° Alette Girante	7
Posizione Girante	19

**KW**

**TOYOTA**
**Avensis I, Liftback, Station Wagon**

2.0 D	85	09/02 → 02/03	D	1CD-FTV
2.0 D-4D	81	10/99 → 02/03	D	1CD-FTV

**Avensis II, Liftback, Station Wagon**

2.0 D-4D	85	04/03 → 11/08	D	1CD-FTV → 06-2004
----------	----	---------------	---	-------------------

**Avensis Verso**

2.0 D-4D	85	08/01 → 08/05	D	1CD-FTV
----------	----	---------------	---	---------

**Corolla VI, Liftback, Station Wagon, Compact**

2.0 D-4D	66	09/00 → 11/01	D	1CD-FTV
----------	----	---------------	---	---------

**Corolla VII, Liftback, Station Wagon, Verso**

2.0 D-4D	66	01/02 → 02/07	D	1CD-FTV → 06-2004
	66	01/02 → 12/06	D	1CD-FTV
	85	06/04 → 07/07	D	1CD-FTV
	81	01/02 → 12/06	D	1CD-FTV
	85	05/03 → 02/07	D	1CD-FTV

**Previa II**

2.0 D-4D	85	03/01 → 01/06	D	1CD-FTV
----------	----	---------------	---	---------

**RAV 4 II**

2.0 D-4D 4WD	85	09/01 → 11/05	D	1CD-FTV
--------------	----	---------------	---	---------

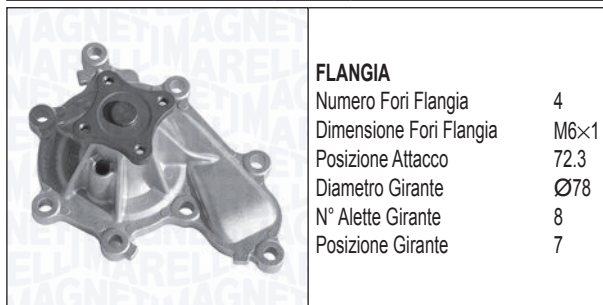
**82023**
**350982023000**

**FLANGIA**

Numero Fori Flangia	4
Dimensione Fori Flangia	M6×1
Posizione Attacco	72.3
Diametro Girante	Ø78
N° Alette Girante	8
Posizione Girante	7

**KW**

**NISSAN**
**Almera II, Hatchback**

2.2 dCi	82	09/03 →	D	YD22DDT
	100	09/03 →	D	YD22DDTi
2.2 Di	81	07/00 →	D	YD22DDT

## 82023 350982023000



### NISSAN

#### Almera Tino

2.2 dCi	82	09/03 →	D	YD22DDT
	100	09/03 →	D	YD22DDTi
2.2 Di	84	08/00 →	D	YD22DDTi

#### Primera III, Hatchback, Station Wagon

2.2 dCi	102	04/03 →	D	YD22DDT
2.2 Di	93	03/02 →	D	YD22DDT

#### X-Trail I

2.2 DCi	84	10/04 → 01/13	D	YD22DDTi
2.2 dCi	100	12/03 → 01/13	D	YD22DDTi
2.2 dCi 4x4	100	12/03 → 01/13	D	YD22DDTi
2.2 DCi FWD	84	06/01 → 09/03	D	YD22DDTi
2.2 Di 4x4	84	07/01 → 10/05	D	YD22ETI

## 82024 350982024000



<b>PULEGGIA</b>	
Diametro Puleggia	Ø63
Altezza Puleggia	39
Posizione Attacco	69.4
Diametro Girante	Ø93.8
N° Alette Girante	7
Posizione Girante	34.3



### FIAT

#### Ducato IV

2.3 JTD	81	04/02 →	D	F1AE0481C
---------	----	---------	---	-----------

#### Ducato V

110 Multijet 2,3 D	83	10/11 →	D	F1AE3481G
120 Multijet 2,3 D	88	07/06 →	D	F1AE0481D
	88	07/06 →	D	F1AE0481D, FPT
120 Multijet 2,3 D 4x4	88	03/10 →	D	F1AE0481D
	93	08/06 →	D	F1AE0481T
130 Multijet 2,3 D	96	01/07 →	D	F1AE0481N, F1AE3481D, F1AGL411D
	96	01/07 →	D	F1AE3481D, F1AGL411D
150 Multijet 2,3 D	109	06/11 →	D	F1AE3481E

## 82024 350982024000



### IVECO

#### Daily III

29 L 12	85	09/02 → 04/06	D	F1AE0481B
29 L 12 V	85	09/02 → 07/07	D	F1AE0481B

## 82025 350982025000



<b>PULEGGIA</b>	
Diametro Puleggia	Ø57
Numero Denti/Gole Puleggia	23
Altezza Puleggia	30
Posizione Attacco	45.7
Diametro Girante	Ø60
N° Alette Girante	8
Posizione Girante	48.5



### AUDI

#### A1, Sportback

2.0 TFSI quattro	188	03/12 →	B	CDLH
------------------	-----	---------	---	------

#### A3 II, Sportback, Cabriolet

2.0 TFSI	147	09/04 → 03/13	B	AXX, BPY, BWA, CAWB, CBFA, CCZA
	147	09/04 → 08/12	B	AXX, BWA, CAWB, CCZA
2.0 TFSI quattro	147	09/04 → 03/13	B	AXX, BPY, BWA, CCZA
	147	09/04 → 08/12	B	AXX, BWA, CCTA, CCZA
S3 quattro	188	02/07 → 08/12	B	BZC, CDLC
	188	07/08 → 03/13	B	CDLC
	195	11/06 → 08/12	B	BHZ, CDLA

#### A4 II, Avant, Cabriolet

2.0 TFSI 16V	147	01/06 → 03/09	B	BWE, BWT
2.0 TFSI quattro	147	11/05 → 03/09	B	BWT

#### A4 III, Avant

2.0 TFSI	125	10/06 → 06/08	B	BPJ, BYK
	147	11/04 → 06/08	B	BGB, BPG, BWE, BWT
	147	11/04 → 06/08	B	BGB, BWE
	162	06/05 → 06/08	B	BUL

**82025 350982025000**

**AUDI**
**A4 III, Avant**

2.0 TFSI quattro	147	11/04 → 06/08	B	BGB, BPG, BWE, BWT
	147	11/04 → 06/08	B	BGB, BWE, BWT
	162	06/05 → 06/08	B	BUL

**A6 III, Avant, Allroad**

2.0 TFSI	125	06/05 → 08/11	B	BPJ
	125	06/05 → 03/11	B	BPJ, BYK

**TT II, Roadster**

2.0 TFSI	147	08/06 → 06/10	B	BPY, BWA, CCTA
2.0 TFSI quattro	147	06/08 → 06/10	B	BWA, CCZA
	147	06/08 → 06/10	B	CCZA
2.0 TTS quattro	195	05/08 → 06/14	B	CDLA, CDMA
	200	05/08 → 06/14	B	CDLB

**SEAT**
**Altea, Altea XL**

2.0 TFSI	147	04/06 → 05/09	B	BWA
2.0 TFSI 4x4	147	06/07 → 05/09	B	BWA

**Leon II**

2.0 TFSI	136	09/05 → 05/06	B	BWA1
	147	05/05 → 03/09	B	BWA
	177	11/06 → 05/11	B	BWJ, CDLD

**Toledo III**

2.0 TFSI	147	11/05 → 05/09	B	BWA
----------	-----	---------------	---	-----

**SKODA**
**Octavia II, Station Wagon**

2.0 RS	147	10/05 → 02/13	B	BWA, CCZA
--------	-----	---------------	---	-----------

**VOLKSWAGEN**
**Eos**

2.0 TFSI	147	03/06 →	B	BPY, BWA, CAWB, CBFA, CCTA, CCZA
----------	-----	---------	---	----------------------------------

**Golf V, Plus, Variant**

2.0	147	06/07 → 07/09	B	BWA, CAWB, CCTA
2.0 GTI	147	10/04 → 02/09	B	AXX, BPY, BWA, CAWB, CBFA, CCTA
	169	09/06 → 12/08	B	BYD

**82025 350982025000**

**VOLKSWAGEN**
**Golf VI, Variant, Cabrio**

2.0 GTi	147	06/09 → 11/13	B	CBFA, CCTA, CCZA
	173	05/11 → 11/12	B	CDLG
2.0 R	195	01/13 →	B	CDLA
2.0 R 4motion	188	11/09 → 11/13	B	CDLC, CRZA
	195	11/09 → 05/11	B	CDLA
	199	11/09 → 11/12	B	CDLF

**Jetta III**

2.0 TFSI	147	10/05 → 10/10	B	AXX, BPY, BWA, CAWB, CBFA, CCTA, CCZA
----------	-----	---------------	---	---------------------------------------

**Passat VI, Variant, CC**

2.0 FSI	147	07/05 → 07/10	B	AXX, BPY, BWA, CAWB, CBFA, CCTA, CCZA
	147	06/08 → 01/12	B	CAWB, CBFA, CCTA, CCZA

**Polo VI (6R)**

2.0 R WRC	162	08/13 →	B	CDLJ
-----------	-----	---------	---	------

**Scirocco III**

2.0 R	188	11/09 →	B	CDLC
	195	11/09 →	B	CDLA

**82026 350982026000**

	<b>FLANGIA</b>	
	Numero Fori Flangia	4
	Dimensione Fori Flangia	M6×1
	Posizione Attacco	57
	Diametro Mozzo	Ø24
	Diametro Girante	Ø59
	N° Alette Girante	8
	Posizione Girante	23.3

**FIAT**
**Sedici**

1.6 16V	79	06/06 →	B	M16A
	88	06/06 →	B	M16A
1.6 16V 4x4	79	06/06 →	B	M16A
	88	06/06 →	B	M16A

**82026**
**350982026000**

**SUBARU**
**Justy III**

1.3 AWD	69	09/03 →	B	M13A	
1.5 AWD	73	09/03 →	B	M15A	

**SUZUKI**
**Ignis I**

1.3	61	10/00 → 09/03	B	M13A	M: M13A
1.3 4WD	61	10/00 → 09/03	B	M13A	

**Ignis II**

1.3	69	09/03 →	B	M13A	
1.3 4x4	69	09/03 →	B	M13A	
1.5	73	09/03 →	B	M15A	
1.5 4x4	73	09/03 →	B	M15A	
1.5 Sport	80	12/03 →	B	M15A	

**Jimny**

1.3 16V	60	02/01 →	B	M13A	
1.3 16V 4WD	60	02/01 →	B	M13A	M: G13BB
1.3 16V 4x4	63	08/05 →	B	M13A	
1.3 4WD	62	05/14 →	B	M13A	
1.3 4x4	65	09/00 → 08/02	B	M13A	

**Liana**

1.3	66	03/02 →	B	M13A	
1.6	76	07/01 → 12/07	B	M16A	
	76	03/02 →	B	M16A	
1.6 4WD	76	07/01 → 12/07	B	M16A	
	76	03/02 →	B	M16A	
	78	04/02 →	B	M16A	
1.6 i	78	04/02 →	B	M16A	

**Swift III**

1.3	68	02/05 →	B	M13A	
1.3 4x4	66	01/06 →	B	M13A	
	68	02/05 →	B	M13A	
1.5	75	02/05 →	B	M15A	
1.5 4x4	74	02/05 →	B	M15A	
1.6	92	05/06 →	B	M16A	

**Swift IV**

1.6	100	01/12 →	B	M16A	
-----	-----	---------	---	------	--

**SX4**

1.5	73	06/06 →	B	M15A	
1.6	74	06/06 →	B	M16A	
	75	10/07 →	B	M16A	
	79	10/07 →	B	M16A	
1.6 VVT	79	06/06 →	B	M16A	
	88	07/09 →	B	M16A	

**82026**
**350982026000**

**SUZUKI**
**SX4**

1.6 VVT 4x4	79	06/06 →	B	M16A	
	88	07/09 →	B	M16A	

**Vitara**

1.6	88	02/15 →	B	M16A	
-----	----	---------	---	------	--

**Wagon R+ II**

1.3	65	08/01 →	B	M13A	
	69	09/03 →	B	M13A	
1.3 4WD	69	09/03 →	B	M13A	

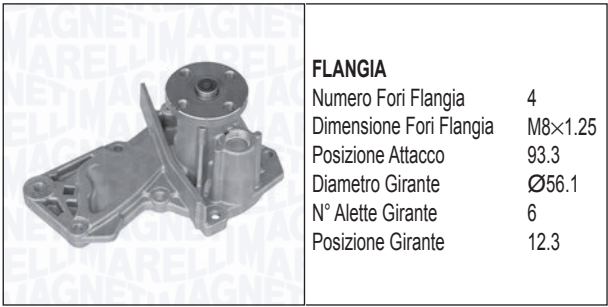
**82027**
**350982027000**

**FORD**
**B-Max, Van**

1.4	66	10/12 →	B	SPJD	
	63	08/13 →		RTJC	
1.4 LPG	66	08/13 →		RTJC	
	77	10/12 →	B	IQJA	

**C-Max I**

1.6	74	02/07 → 09/10	B	HWDA, HWDB, SHDA, SHDB, SHDC	
	85	04/07 → 09/10	B	HXDA, HXDB, SIDA	

**C-Max II, Van**

1.6 CNG	86	01/13 →		MUDA	
1.6 EcoBoost	110	12/10 →	B	JQDA, JQDB	
	134	12/10 →	B	JTDA, JTDB	
1.6 Flexifuel	88	02/11 →		MUDA	
1.6 LPG	86	02/12 →		MUDA	
	88	02/12 →		MUDA	
1.6 Ti	63	12/10 →	B	XTDA	
	77	12/10 →	B	IQDA, IQDB	
	92	12/10 →	B	PNDA	

**82027 350982027000**

**FORD**
**Ecosport II**

1.5 Ti	82	10/13 →	B	UEJB	
1.6 Ti-VCT	90	08/12 →	B	HXJD, IQJB	

**Fiesta V, Van**

1.25 16V	51	03/03 → 06/08	B	M7JA, M7JB	05-2005 →
	55	05/02 → 06/08	B	FUJA, FUJB	05-2005 →
1.4 16V	59	11/01 → 06/08	B	FXJA, FXJB	05-2005 →
1.6 16V	74	11/01 → 06/08	B	FYJA, FYJB	05-2005 →

**Fiesta VI, Van**

1.25	44	06/08 →	B	STJA, STJB	
	44	10/12 →	B	STJB	
	60	01/09 →	B	SNJA, SNJB	
1.4	60	06/08 →	B	SNJA, SNJB, SNJC, SNJD	
	71	06/08 →	B	SPJA, SPJC	
1.4 LPG	68	01/09 →		RTJA, RTJB	
	71	01/09 →		RTJA, RTJB	
1.6 ST	134	03/13 →	B	JTJA	
1.6 Ti	77	09/12 →	B	IQJA	
	88	06/08 →	B	HXJA, HXJB	
	99	12/10 →	B	U5JA	

**Focus C-Max**

1.6	74	10/03 → 03/07	B	HWDA, HWDB	05-2005 →
1.6 Ti	85	08/04 → 03/07	B	HXDA, SIDA	05-2005 →

**Focus II, Station Wagon, Cabrio**

1.4	59	07/04 → 09/12	B	ASDA, ASDB	05-2005 →
	59	04/05 → 09/12	B	ASDA, ASDB	
1.6	74	07/04 → 09/12	B	HWDA, HWDB, SHDA, SHDB, SHDC	05-2005 →
	74	10/06 → 07/11	B	HWDA, HWDB, SHDA, SHDB, SHDC	
1.6 LPG	85	10/09 → 07/11		SIDA	
1.6 Ti	85	07/04 → 09/12	B	HXDA, HXDB	05-2005 →
	85	04/05 → 09/12	B	HXDA, HXDB	
	85	07/04 → 09/12	B	HXDA, HXDB, SIDA	05-2005 →

**Focus III, Station Wagon, Van**

1.6 EcoBoost	110	07/10 →	B	JQDA, JQDB, YUDA	
	134	07/10 →	B	JTDA, JTDB	
1.6	88	07/10 →		MUDA	
Flexifuel	110	07/13 →		YUDA	

**82027 350982027000**

**FORD**
**Focus III, Station Wagon, Van**

1.6 LPG	86	02/12 →		MUDA	
	88	02/12 →		MUDA	
1.6 Ti	63	08/11 →	B	XTDA	
	77	07/10 →	B	IQDB	
	88	02/12 →	B	MUDA	
	92	07/10 →	B	PNDA	

**Fusion**

1.25	55	08/04 → 12/12	B	FUJA, FUJB	05-2005 →
1.4	59	08/02 → 12/12	B	FXJA, FXJB, FXJC	05-2005 →
1.4 LPG	59	01/10 → 12/12		UTJA	
1.6	74	08/02 → 11/08	B	FYJA, FYJB, FYJC	05-2005 →

**Galaxy II**

1.6 EcoBoost	118	11/10 → 06/15	B	JTWA, JTWB	
--------------	-----	---------------	---	------------	--

**Grand C-Max**

1.6 EcoBoost	110	12/10 →	B	JQDA, JQDB	
	134	12/10 →	B	JTDA, JTDB	
1.6 Ti	77	12/10 →	B	IQDA, IQDB	
	92	12/10 →	B	PNDA	

**Kuga II, Van**

1.6 EcoBoost	110	03/13 →	B	JQMA, JQMB	
1.6 EcoBoost 4x4	110	03/13 →	B	JQMA, JQMB	
	134	03/13 →	B	JTMA	

**Mondeo IV, Station Wagon**

1.6 EcoBoost	118	02/11 → 09/14	B	JTBA	
	118	02/11 → 09/14	B	JTBB	
1.6 Ti	81	03/07 → 09/14	B	RHBA	
	88	07/10 → 09/14	B	KGBA	
	92	03/07 → 09/14	B	PNBA	

**S-Max**

1.6 EcoBoost	118	02/11 →	B	JTWA, JTWB	
--------------	-----	---------	---	------------	--

**Tourneo II Connect, Courier, Custom**

1.6 EcoBoost	110	11/13 →	B	JQGA	
--------------	-----	---------	---	------	--

**Transit Connect II, Courier**

1.6 EcoBoost	110	11/13 →	B	JQGA	
--------------	-----	---------	---	------	--

**82027**
**350982027000**

**VOLVO**
**S 60 II**

T3	110	04/10 →	B	B4164T3
T4	132	04/10 →	B	B4164T
T4F	132	04/11 →	FF	B4164T2

**S 80 II**

T4	132	10/10 →	B	B4164T
T4F	132	05/11 →	FF	B4164T2

**V 40 II**

T2 GTDi	88	03/13 →	B	B4164T4
T3 GTDi	110	03/12 →	B	B4164T3
T4	147	04/14 →	B	B4164T
T4 GTDi	132	03/12 →	B	B4164T

**V 60**

T3	110	09/10 →	B	B4164T3
T4	132	09/10 →	B	B4164T
T4F	132	04/11 →	FF	B4164T2

**V 70 III**

1.6 T4F	132	01/11 →	FF	B4164T2
T4	132	10/10 →	B	B4164T

**82028**
**350982028000**

**FLANGIA**

Numero Fori Flangia	4
Dimensione Fori Flangia	M6x1
Posizione Attacco	69.5
Diametro Mozzo	Ø25
Diametro Girante	Ø56
N° Alette Girante	6
Posizione Girante	5.5

**NISSAN**
**Almera II, Hatchback**

1.5	72	10/02 →	B	QG15DE
	66	07/00 →	B	QG15DE
	77	03/01 →	B	GA15DE, QG15DE
1.5 XL	77	03/01 →	B	QG15DE
1.8	84	07/00 →	B	QG18DE
	85	10/02 →	B	QG18DE

**Almera Tino**

1.8	84	08/00 →	B	QG18DE
	85	12/02 →	B	QG18DE

**82028**
**350982028000**

**NISSAN**
**Primera II, Hatchback, Station Wagon**

1.8 16V	84	08/99 → 12/01	B	QG18DE
1.6	78	03/02 →	B	QG16DE
1.6 Visia	80	01/02 →	B	QG16DE
1.8	85	03/02 →	B	QG18DE

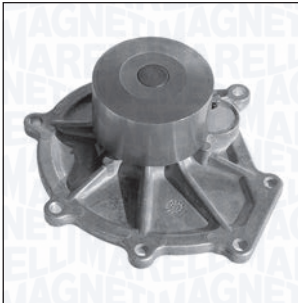
**82029**
**350982029000**

**PULEGGIA**

Diametro Puleggia	Ø66
Altezza Puleggia	34
Posizione Attacco	57
Diametro Girante	Ø74
N° Alette Girante	7
Posizione Girante	36.5

**LAND ROVER**
**Freelander I**

2.5 V6 4x4	130	11/00 → 10/06	B	25K4F
------------	-----	---------------	---	-------

**MG**
**MG ZS**

180	130	07/01 → 04/05	B	25K4F
-----	-----	---------------	---	-------

**ROVER**
**45**

2.0 V6	110	02/00 → 05/05	B	20K4F
--------	-----	---------------	---	-------

**75, Station Wagon**

2.0 V6	110	02/99 → 05/05	B	20K4F
	129	02/99 → 10/01	B	KV6
	2.5 V6	130	10/01 → 05/05	B
130		08/01 → 05/05	B	KV6

**82030**
**350982030000**

	<b>PULEGGIA</b>		
	Diametro Puleggia		Ø90
	Altezza Puleggia		Ø30.9
	Posizione Attacco		79.8
	Diametro Girante		Ø74
	N° Alette Girante		6
	Posizione Girante		13.3

**MERCEDES-BENZ**
**Classe V**

V 200 CDI	75	03/99 → 07/03	D	OM611.980
	90	03/99 → 07/03	D	OM611.980

**Vito I (W638)**

108 CDI 2.2	60	03/99 → 07/03	D	OM611A (60KWCDI)
	60	03/99 → 07/03	D	OM611A (60KWCDI)
110 CDI 2.2	75	03/99 → 07/03	D	OM611LA (75KWCDI)
	75	03/99 → 07/03	D	OM611LA (75KWCDI)
112 CDI 2.2	90	03/99 → 07/03	D	OM611.980

**82032**
**350982032000**

	<b>FLANGIA</b>		
	Numero Fori Flangia		3
	Dimensione Fori Flangia		M6x1
	Posizione Attacco		47
	Diametro Centraggio		Ø20
	Diametro Girante		Ø59.6
	N° Alette Girante		5
Posizione Girante		23.3	

**BMW**
**1 II (F20, F21)**

114 i	75	11/11 →	B	N13B16A	→ 11-2012
116 i	100	12/10 →	B	N13B16A	→ 11-2012
118 i	100	03/15 →	B	N13B16A	→ 11-2012
	125	11/10 →	B	N13B16A	→ 11-2012
120 i	130	03/15 →	B	N13B16A	→ 11-2012

**3 VI (F30, F35, F80), Touring (F31), GT (F34)**

316 i	100	10/12 →	B	N13B16A	→ 11-2012
320 i	125	02/12 →	B	N13B16A	→ 11-2012

**82032**
**350982032000**

**CITROËN**
**Berlingo II, Van**

1.6 VTi 120	88	11/09 →	B	5FS (EP6C)
1.6 VTi 95	72	07/10 →	B	5FK (EP6CB)

**C 3 II, Picasso**

1.4 LPG	70	06/13 →		8FN (EP3)
1.4 VTi	72	11/09 →	B	8FR (EP3)
1.4 VTi 95	70	02/09 →	B	8FN (EP3), 8FP (EP3), 8FS (EP3)
	70	11/09 →	B	8FP (EP3)
1.4 VTi 95 LPG	70	01/12 →		8FN (EP3)
1.6 VTi 120	88	11/09 →	B	5FS (EP6C)
	88	02/09 →	B	5FS (EP6C), 5FW (EP6)

**C 4 I, Coupé, Picasso, Grand Picasso**

1.6 16V	103	07/08 →	B	5FT (EP6DT)
	110	10/08 →	B	5FX (EP6DT)
1.6 THP 140	103	07/08 → 07/11	B	5FT (EP6DT)
1.6 THP 150	110	07/08 → 07/11	B	5FX (EP6DT)
1.6 THP 155	115	09/10 →	B	5FV (EP6CDT)
1.6 VTi 120	88	07/08 → 07/11	B	5FW (EP6)

**C 4 II, Picasso, Grand Picasso**

1.4 VTi 95	70	11/09 →	B	8FP (EP3)
1.6 THP 155	115	09/13 →	B	5FV (EP6CDT)
1.6 THP 165	121	07/14 →	B	5GZ (EP6FDT)
1.6 VTi 120	88	09/13 →	B	5FS (EP6C)
1.6 VTi 120 LPG	88	09/11 →		5FS (EP6C)

**C 5 III, Break**

1.6 THP 150	110	07/10 →	B	5FN (EP6CDT)
1.6 THP 155	115	04/09 →	B	5FV (EP6CDT)
1.6 VTi 120	88	07/10 →	B	5FS (EP6C)

**DS 3, Cabrio**

1.4 VTi 95	70	04/10 → 07/15	B	8FP (EP3)
1.4 VTi 95 LPG	70	08/12 → 07/15		8FN (EP3)
1.4 VTi 98	72	11/09 → 07/15	B	8FR (EP3)

**82032**
**350982032000**

**CITROËN**
**DS 3, Cabrio**

1.6 Racing	147	02/11 → 07/15	B	5FU (EP6CDTX)	
	152	02/11 → 07/15	B	5FD (EP6DTS)	
1.6 THP 150	110	01/13 → 07/15	B	5FN (EP6CDT)	
	110	01/10 → 07/15	B	5FN (EP6CDT), 5FX (EP6DT)	
1.6 THP 155	115	04/10 → 07/15	B	5FR (EP6DT), 5FV (EP6CDT)	
	115	01/13 → 07/15	B	5FV (EP6CDT)	
1.6 VTi 120	88	04/10 → 07/15	B	5FS (EP6C)	

**DS 4**

1.6 THP 155	115	04/11 → 07/15	B	5FV (EP6CDT)	
1.6 THP 160	120	04/12 → 07/15	B	5FM (EP6DT)	
1.6 THP 165	121	01/12 → 07/15	B	5FM (EP6DT), 5GZ (EP6FDT)	
1.6 THP 200	147	04/11 → 07/15	B	5FU (EP6DTX)	
1.6 VTi 120	88	04/11 → 07/15	B	5FS (EP6C)	

**DS 5**

1.6 THP 155	115	11/11 → 07/15	B	5FV (EP6CDT)	
1.6 THP 200	147	11/11 → 07/15	B	5FU (EP6DTX)	

**DS**
**DS 3**

1.6 THP 165	121	07/15 →	B		
-------------	-----	---------	---	--	--

**DS 4 / DS 4 CROSSBACK**

1.6 THP 165	121	07/15 →	B		
-------------	-----	---------	---	--	--

**DS5**

1.6 THP 210	155	04/15 →	B		
-------------	-----	---------	---	--	--

**MINI**
**Mini Countryman (R60)**

Cooper	85	06/10 →	B	N16B16A	→ 11-2012
	90	06/10 →	B	N16B16A	→ 11-2012
Cooper ALL4	90	11/14 →	B	N18B16A	

**82032**
**350982032000**

**MINI**
**Mini Countryman (R60)**

Cooper S	135	06/10 →	B	N18B16A	→ 11-2012
	147	02/12 →	B	N18B16A	→ 11-2012
Cooper S ALL4	120	06/10 →	B	N18B16A	→ 11-2012
	135	06/10 →	B	N18B16A	→ 11-2012
Cooper S JCW	160	09/12 →	B	N18B16A	→ 11-2012
One	72	06/10 →	B	N16B16A	→ 11-2012

**Mini I (R50,R52, R53)**

John Cooper Works	160	03/06 → 09/06	B	W11B16A	
-------------------	-----	---------------	---	---------	--

**Mini II (R55, R56,R57,R58, R59)**

Cooper	85	03/10 → 11/13	B	N12B16A, N16B16A	→ 11-2012
	85	03/09 →	B	N16B16A	→ 11-2012
	88	10/06 → 02/12	B	N12B16A	→ 11-2012
	88	10/07 → 12/13	B	N12B16A, N16B16A	→ 11-2012
	90	09/09 → 11/13	B	N16B16A	→ 11-2012
Cooper S	120	10/07 → 02/10	B	N14B16A	→ 11-2012
	120	03/10 → 11/13	B	N18B16A	→ 11-2012
	120	09/11 →	B	N18B16A	
	128	10/06 → 01/11	B	N14B16A	→ 11-2012
	135	03/10 → 11/13	B	N18B16A	→ 11-2012
	135	09/11 →	B	N18B16A	
	147	03/10 →	B	N18B16A	→ 11-2012
	147	01/12 → 11/13	B	N18B16A	
Cooper SD	105	02/11 →	D	N47C20A	
John Cooper Works	141	10/08 → 02/10	B	N14B16A	
	141	11/06 → 12/11	B	N14B16C	→ 11-2012
	155	03/08 → 08/12	B	N14B16C	
	155	03/08 → 11/13	B	N14B16C	→ 11-2012
John Cooper Works GP	160	09/12 → 11/13	B	N18B16C	→ 11-2012
One	55	03/09 → 03/10	B	N12B14A	→ 11-2012
	70	11/06 → 03/10	B	N12B14A	→ 11-2012
	55	03/10 → 11/13	B	N16B16A	→ 11-2012
	72	03/10 → 11/13	B	N16B16A	→ 11-2012



**82032 350982032000**

**PEUGEOT**
**207, Station Wagon, CC, Van**

1.4 16V	70	06/07 →	B	8FS (EP3), EP3, EP3C
	72	10/09 →	B	8FR (EP3)
1.6 16V	88	02/07 →	B	5FS (EP6C), 5FW (EP6), EP6
1.6 16V RC	128	02/07 →	B	5FY (EP6DTS)
1.6 16V Turbo	110	02/06 →	B	5FX (EP6DT)
	115	10/09 →	B	5FR (EP6DT)
	115	10/09 →	B	5FR (EP6DT), EP6CDT
1.6 16V VTi	88	02/07 →	B	5FS (EP6C), 5FW (EP6), EP6

**208**

1.4 GPL	70	10/13 →		EP3C
1.4 VTi	70	03/12 →	B	8FS (EP3), EP3C
1.6	88	03/12 →	B	5FS (EP6C)
	115	03/12 →	B	5FV (EP6DT), EP6CDT
1.6 GTi	147	08/12 →	B	5FU (EP6CDTX)
1.6 GTi	153	10/14 →	B	
1.6 THP 165	121	03/15 →	B	

**308 I, Station Wagon, CC**

1.4 16V	70	09/07 →	B	8FS (EP3)
	70	09/07 →	B	8FS (EP3), EP3
	72	12/09 →	B	8FR (EP3)
1.6	120	01/12 →	B	5FV (EP6DT)
1.6 16V	88	09/07 →	B	5FW (EP6), EP6
	88	06/09 →	B	EP6
	103	09/07 →	B	5FT (EP6DT)
	110	09/07 →	B	5FX (EP6DT)
	115	10/09 →	B	EP6CDT
	128	03/08 →	B	5FY (EP6DTS)
1.6 Bioflex	82	03/09 →		NFU (TU5JP4)
1.6 GTi	147	07/10 →	B	EP6CDTX
1.6 THP	147	10/10 →	B	EP6CDTX

**82032 350982032000**

**PEUGEOT**
**308 II Station Wagon**

1.6	115	09/13 →	B	5FV (EP6DT)
1.6 GT 205	151	06/14 →	B	
1.6 GTi	184	08/15 →	B	
	200	06/15 →	B	5GN (EP6FDTR)
1.6 THP 125	92	09/13 →	B	
1.6 THP 155	115	03/14 →	B	5FV (EP6DT)

**508, Station Wagon**

1.6	120	01/12 →	B	5GZ (EP6FDT)
	121	09/11 →	B	
1.6 THP	110	11/10 →	B	5FN (EP6CDT)
	110	11/10 →	B	5FX (EP6DT)
	115	11/10 →	B	EP6CDT
1.6 VTi	85	11/10 →	B	5FH (EP6C)
	88	11/10 →	B	5FS (EP6C)

**2008**

1.6 VTi	88	03/13 →	B	5FS (EP6C)
---------	----	---------	---	------------

**3008**

1.6 THP	110	06/09 →	B	5FX (EP6DT)
	115	06/09 →	B	5FV (EP6DT)
1.6 Turbo	121	05/14 →	B	5GZ (EP6FDT)
1.6 VTi	88	06/09 →	B	5FS (EP6C), 5FW (EP6), EP6

**5008**

1.6	120	02/12 →	B	5GZ (EP6FDT)
1.6 16V	88	09/09 →	B	5FS (EP6C), 5FW (EP6), EP6
	115	09/09 →	B	EP6CDT
1.6 THP 150	110	02/12 →	B	
1.6 THP 165	121	02/12 →	B	5GZ (EP6FDT)

**Partner II, Tepee**

1.6	72	11/10 →	B	5FK (EP6CB)
-----	----	---------	---	-------------

**RCZ**

1.6 16V	115	03/10 →	B	EP6CDT
	147	06/10 →	B	EP6CDTX
1.6 THP 270	199	06/13 →	B	5FG (EP6CDTR)

**82033**
**350982033000**

**ALBERINO**

Diametro Alberino Ø11.9  
 Tipo Filetto Alberino M12×1.25  
 Posizione Attacco 26.5  
 Diametro Girante Ø71.7  
 N° Alette Girante 7  
 Posizione Girante 71.3

**KW**

**VOLKSWAGEN**
**Multivan V**

2.5 TDI	96	04/03 → 11/09	D	AXD, BNZ
	120	11/03 → 11/09	D	BLJ
	128	04/03 → 11/09	D	AXE, BPC
2.5 TDI 4motion	96	07/04 → 11/09	D	AXD, BNZ
	128	07/04 → 11/09	D	AXE, BPC

**Touareg I**

2.5 R5 TDI	120	08/03 → 05/10	D	BLK, BPD
	128	01/03 → 05/10	D	BAC, BPE

**Transporter V**

2.5 TDI	96	04/03 → 11/09	D	AXD, BNZ
	120	11/03 → 11/09	D	BLJ
	128	04/03 → 11/09	D	AXE, BPC
2.5 TDI 4motion	96	07/04 → 11/09	D	AXD, BNZ
	128	07/04 → 11/09	D	AXE, BPC

**82034**
**350982034000**

**PULEGGIA**

Diametro Puleggia Ø94.3  
 Numero Denti/Gole Puleggia 6  
 Altezza Puleggia 25  
 Posizione Attacco 90.8  
 Diametro Girante Ø64.9  
 N° Alette Girante 6  
 Posizione Girante -0.7

**KW**

**BMW**
**3 IV (E46), Touring, Cabrio, Coupé, Compact**

320 Cd	110	02/05 → 12/07	D	M47D20 (204D4)	C: A
	110	11/03 → 07/06	D	M47D20 (204D4), M47N204D4	C: A
320 d	110	09/01 → 02/05	D	M47D20 (204D4)	C: A

**82034**
**350982034000**

**KW**

**BMW**
**3 IV (E46), Touring, Cabrio, Coupé, Compact**

330 Cd	150	08/05 → 12/07	D	M57D30 (306D2), M57N306D2
330 d	150	03/03 → 02/05	D	M57D30 (306D2), M57N306D2
330 xd	150	03/03 → 02/05	D	M57D30 (306D2), M57N306D2

**7 IV (E65, E66)**

730 d	155	10/02 → 07/08	D	M57D30 (306D3), M57N306D2
	160	10/02 → 07/08	D	M57D30 (306D2)
730 Ld	170	07/05 → 12/09	D	M57306D3, M57D30 (306D3)

**X5 I (E53)**

3.0 d	155	09/03 → 12/06	D	M57D30 (306D2), M57N306D2
	160	12/03 → 12/06	D	M57D30 (306D2)

**82036**
**350982036000**

**PULEGGIA**

Diametro Puleggia Ø53.2  
 Numero Denti/Gole Puleggia 3  
 Altezza Puleggia 10.6  
 Posizione Attacco 33.5  
 Diametro Girante Ø78.5  
 N° Alette Girante 6  
 Posizione Girante 24.6

**KW**

**FORD**
**Maverick II**

3.0 V6 24V	145	02/01 →	B	AJ	05-2003 →
	149	03/04 →	B	AJ	

**Mondeo III, Station Wagon**

2.5 V6 24V	125	10/00 → 03/07	B	LCBD
3.0 V6 24V	150	09/04 → 03/07	B	REBA
ST220	166	04/02 → 03/07	B	MEBA

**82038**
**350982038000**

**FLANGIA**

Numero Fori Flangia	4
Dimensione Fori Flangia	M8x1.25
Posizione Attacco	59.2
Diametro Centraggio	Ø32
Diametro Girante	Ø76.5
N° Alette Girante	6
Posizione Girante	5.1



**KW**

**KIA**
**Carnival I**

2.9 TD	93	08/99 → 10/01	D	J3
--------	----	---------------	---	----

**Carnival II**

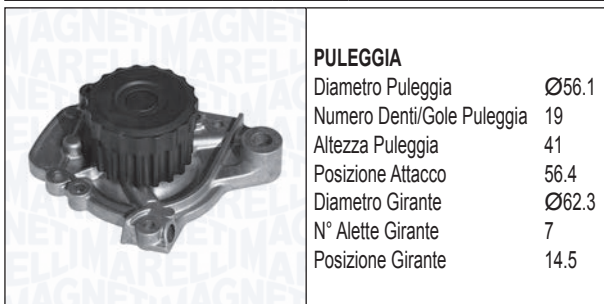
2.9 TD	93	01/99 →	D	J3
--------	----	---------	---	----

**82039**
**350982039000**

**PULEGGIA**

Diametro Puleggia	Ø56.1
Numero Denti/Gole Puleggia	19
Altezza Puleggia	41
Posizione Attacco	56.4
Diametro Girante	Ø62.3
N° Alette Girante	7
Posizione Girante	14.5

**KW**

**HONDA**
**Civic VII, Hatchback, Coupé**

1.4	66	12/00 → 09/05	B	D14Z5
1.4 iS	66	02/01 → 09/05	B	D14Z5, D14Z6
1.6	84	02/01 → 09/05	B	R16A1
	81	02/01 → 09/05	B	D16V1
1.6 i	81	02/01 → 12/05	B	D16V1
1.7	85	02/01 → 09/05	B	D17A6
1.7 i	88	05/01 → 12/05	B	D17A8
1.7 i VTEC	92	05/01 → 12/05	B	D17A5, D17A9

**FR-V**

1.7	92	08/04 →	B	D17A2
-----	----	---------	---	-------

**Stream I**

1.7 16V	92	05/01 →	B	D17A2
2.0 16V	115	05/01 →	B	K20A1

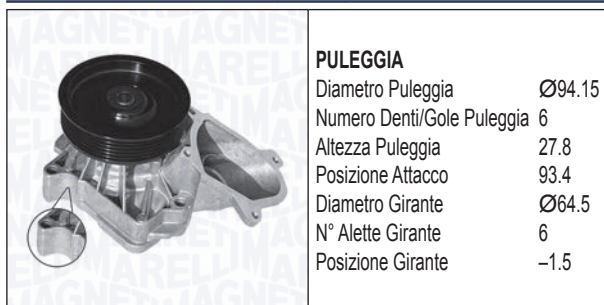
**82040**
**350982040000**

**PULEGGIA**

Diametro Puleggia	Ø94.15
Numero Denti/Gole Puleggia	6
Altezza Puleggia	27.8
Posizione Attacco	93.4
Diametro Girante	Ø64.5
N° Alette Girante	6
Posizione Girante	-1.5

**KW**

**BMW**
**1 I (E81, E87), Coupé (E82), Cabrio (E88)**

118 d	90	11/03 → 09/12	D	M47D20 (204D4), N47D20A, N47D20C
120 d	120	03/07 → 09/12	D	M47D20 (204D4), N47D20A, N47D20C

**3 IV (E46), Touring, Cabrio, Coupé, Compact**

318 d	85	03/03 → 02/05	D	M47D20 (204D4), M47N204D4	→ 03-2004
	85	03/03 → 02/05	D	M47D20 (204D4), M47N204D4	04-2004 →
318 td	85	03/03 → 02/05	D	M47D20 (204D4), M47N204D4	→ 03-2004
	85	03/03 → 02/05	D	M47D20 (204D4), M47N204D4	04-2004 →
320 Cd	110	02/05 → 12/07	D	M47D20 (204D4)	
	110	11/03 → 07/06	D	M47D20 (204D4), M47N204D4	→ 03-2004
	110	11/03 → 07/06	D	M47D20 (204D4), M47N204D4	04-2004 →
320 d	110	09/01 → 02/05	D	M47D20 (204D4)	→ 03-2004
	110	09/01 → 02/05	D	M47D20 (204D4)	04-2004 →

**82040**
**350982040000**

**KW**

**BMW**
**3 IV (E46), Touring, Cabrio, Coupé, Compact**

320 td	110	09/01 → 02/05	D	M47D20 (204D4), M47N204D4	→ 03-2004
	110	09/01 → 02/05	D	M47D20 (204D4), M47N204D4	04-2004 →

**3 V (E90), Touring (E91), Cabrio (E93), Coupé (E92)**

318 d	90	09/05 → 12/11	D	M47D20 (204D4)	
	105	09/05 → 12/11	D	N47D20A, N47D20C	
320 d	110	09/05 → 06/12	D	M47D20 (204D4), M47D20TU	
	110	09/05 → 12/11	D	M47D20 (204D4), M47N204D4	
	120	01/05 → 12/11	D	M47D20 (204D4), N47D20C	
325 d	145	09/06 → 12/11	D	M57306D3, M57D30 (306D3)	
	145	09/06 → 06/12	D	M57306D3, M57D30 (306D3), M57D30TU2	
	145	03/07 → 12/13	D	M57D30 (306D3)	
	145	03/07 → 12/13	D	M57D30 (306D3), M57D30TU2	
	155	01/07 → 12/09	D	M57D30 (306D3)	
330 d	170	03/07 → 12/13	D	M57D30 (306D3)	
	170	09/05 → 12/11	D	M57D30 (306D3), M57D30TU2	
330 xd	170	09/05 → 12/11	D	M57D30 (306D3), M57D30TU2	

**82040**
**350982040000**

**KW**

**BMW**
**3 V (E90), Touring (E91), Cabrio (E93), Coupé (E92)**

335 d	210	09/06 → 12/11	D	M57D30 (306D5), M57N306D5	→ 03-2010
	210	09/06 → 12/13	D	M57D30 (306D5), M57N306D5	

**5 V (E60), Touring (E61)**

520 d	110	09/05 → 03/10	D	M47D20 (204D4)	
	110	09/05 → 12/10	D	M47D20 (204D4), N47D20A, N47D20C	
525 d	120	07/05 → 03/10	D	M47D20 (204D4), N47D20A, N47D20C	
	120	12/04 → 03/10	D	M57D25 (256D1)	
525 d	120	12/04 → 12/10	D	M57N256D4	
	130	06/04 → 03/10	D	M57D25 (256D2), M57D25TU	
525 d	145	01/07 → 03/10	D	M57D30 (306D3)	
	145	09/08 → 03/10	D	M57D30 (306D3)	
525 xd	145	01/07 → 03/10	D	M57D30 (306D3)	
530 d	155	07/03 → 03/10	D	M57D30 (306D2), M57D30 (306D3)	
	155	11/05 → 12/10	D	M57D30 (306D3)	
	160	07/03 → 03/10	D	M57D30 (306D2)	→ 03-2004
	160	07/03 → 03/10	D	M57D30 (306D2)	04-2004 →
	160	06/04 → 12/10	D	M57D30 (306D2), N57306D2	
530 d	170	07/03 → 03/10	D	M57D30 (306D3)	→ 03-2004

**82040 350982040000**

**BMW**
**5 V (E60), Touring (E61)**

530 d	170	07/03 → 03/10	D	M57D30 (306D3)	04-2004 →
	170	07/05 → 12/10	D	M57D30 (306D3)	
	173	01/07 → 03/10	D	M57306D3, M57D30 (306D3)	
530 d xDrive	173	09/08 → 03/10	D	M57D30 (306D3), M57N2306D3	
530 xd	170	07/05 → 03/10	D	M57D30 (306D3)	
	173	01/07 → 03/10	D	M57306D3, M57D30 (306D3)	
	173	01/07 → 12/10	D	M57D30 (306D3)	
535 d	200	09/04 → 03/10	D	M57D30 (306D4)	
	210	01/07 → 03/10	D	M57D30 (306D5), M57N306D5	

**6 II (E63), Cabrio (E64)**

635 d	210	07/07 → 07/10	D	M57D30 (306D5), M57N306D5	
	210	07/07 → 07/10	D	M57D30 (306D5), M57N306D5	

**X3 I (E83)**

2.0 d	110	10/04 → 12/10	D	M47D20 (204D4)	
3.0 d	150	01/04 → 08/05	D	M57D30 (306D2), M57N2306D2	
	160	01/04 → 08/08	D	M57D30 (306D3)	→ 03-2010
3.0 sd	210	09/06 → 08/08	D	M57D30 (306D5)	
xDrive 30 d	160	09/08 → 04/11	D	M57D30 (306D3), M57N2306D3	→ 03-2010
xDrive 35 d	210	09/08 → 08/11	D	M57D30 (306D5)	

**82040 350982040000**

**BMW**
**X5 II (E70)**

3.0 d	155	02/07 → 09/08	D	M57D30 (306D3)	
	173	02/07 → 09/08	D	M57306D3, M57D30 (306D3)	
3.0 sd	210	09/07 → 02/09	D	M57D30 (306D5), M57N306D5	
xDrive 30 d	173	09/08 → 06/13	D	N57D30A	
xDrive 35 d	210	09/08 → 06/13	D	M57D30 (306D5)	

**X6 I (E71, E72)**

30 d	173	05/08 → 08/08	D	M57D30 (306D3)	
35 d	210	05/08 → 08/08	D	M57D30 (306D5)	
xDrive 30 d	173	09/08 → 06/14	D	N57D30A	
xDrive 35 d	210	09/08 → 06/14	D	M57D30 (306D5), N57N306D5	

**82041 350982041000**

	<b>PULEGGIA</b>	
	Diametro Puleggia Altezza Puleggia Posizione Attacco Diametro Girante N° Alette Girante Posizione Girante	Ø57.2 33 25.5 Ø80.6 7 31.8

**AUDI**
**A8 I**

3.3 TDI quattro	165	06/00 → 09/02	D	AKF	
-----------------	-----	---------------	---	-----	--

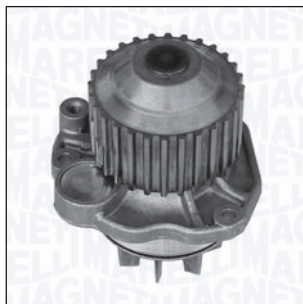
**82042**
**350982042000**

**PULEGGIA**

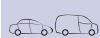
Diametro Puleggia	Ø69.8
Numero Denti/Gole Puleggia	28
Altezza Puleggia	36
Posizione Attacco	54.2
Diametro Girante	Ø69.5
N° Alette Girante	8
Posizione Girante	58.4

**KW**

**CITROËN**
**Xantia I, Break**

3.0 i 24V	140	01/97 → 01/98	B	XFZ (ES9J4)	T →: 08442
-----------	-----	---------------	---	-------------	------------

**Xantia II, Break**

3.0 V6	140	01/98 → 04/03	B	XFZ (ES9J4)	T →: 08442
--------	-----	---------------	---	-------------	------------

**XM II, Break**

3.0 V6	140	04/97 → 10/00	B	XFZ (ES9J4)	T →: 08442
--------	-----	---------------	---	-------------	------------

**PEUGEOT**
**407, Station Wagon, Coupé**

3.0 24V	140	10/96 → 05/04	B	XFZ (ES9J4)	T →: 08442
---------	-----	---------------	---	-------------	------------

3.0 V6 24V	140	03/97 → 12/04	B	XFZ (ES9J4)	T →: 08442
------------	-----	---------------	---	-------------	------------

**RENAULT**
**Espace III**

3.0 V6 24V	140	10/98 → 10/02	B	L7X727	T →: 08442
------------	-----	---------------	---	--------	------------

**Laguna I, Grantour**

3.0 24V	140	03/97 → 03/01	B	L7X700, L7X701	T →: 08442
---------	-----	---------------	---	-------------------	------------

**Safrane II**

2.9 24V	140	03/99 → 12/00	B	L7X713	T →: 08442
---------	-----	---------------	---	--------	------------

**82044**
**350982044000**

**PULEGGIA**

Diametro Puleggia	Ø62
Altezza Puleggia	35.2
Posizione Attacco	58
Diametro Girante	Ø74
N° Alette Girante	7
Posizione Girante	19.2

**KW**

**TOYOTA**
**Avensis II, Liftback, Station Wagon**

2.0 D-4D	85	04/03 → 11/08	D	1CD-FTV	07-2004 →
----------	----	---------------	---	---------	-----------

**Corolla Verso**

2.0 D-4D	85	04/04 → 03/09	D	1CD-FTV	
----------	----	---------------	---	---------	--

**Corolla VII, Liftback, Station Wagon, Verso**

2.0 D-4D	66	01/02 → 02/07	D	1CD-FTV	07-2004 →
	85	04/04 → 02/07	D	1CD-FTV	

**82045**
**350982045000**

**FLANGIA**

Numero Fori Flangia	3
Dimensione Fori Flangia	M6×1
Posizione Attacco	70.2
Diametro Girante	Ø48.3
N° Alette Girante	7
Posizione Girante	5.2

**KW**

**HONDA**
**Civic VIII, Hatchback, Coupé**

1.4	61	09/05 →	B	L13A7	
-----	----	---------	---	-------	--

**Jazz II**

1.2	57	03/02 → 07/08	B	L12A1	
-----	----	---------------	---	-------	--

1.3	61	03/02 → 07/08	B	L13A1	
-----	----	---------------	---	-------	--

**Jazz III**

1.2	66	07/08 →	B	L12B1	
-----	----	---------	---	-------	--

1.3 i	73	07/08 →	B	L13Z1	
-------	----	---------	---	-------	--

**82046**
**350982046000**

**ALBERINO**

Diametro Alberino	Ø12
Posizione Attacco	65
Diametro Girante	Ø68
N° Alette Girante	8
Posizione Girante	5.5

**KW**

**AUDI**
**A4 II, Avant, Cabriolet**

S4 quattro	253	03/03 → 12/04	B	BBK
------------	-----	---------------	---	-----

**A4 III, Avant**

S4 quattro	253	11/04 → 06/08	B	BBK
	253	11/04 → 06/08	B	BBK, BHF

**A6 III, Avant, Allroad**

4.2 quattro	246	05/04 → 05/06	B	BAT
-------------	-----	---------------	---	-----

**A8 II**

4.0 TDI quattro	202	05/03 → 07/05	D	ASE
-----------------	-----	---------------	---	-----

4.2 TDI quattro	235	01/05 → 06/05	D	BMC
	240	07/05 → 07/10	D	BVN

**Allroad**

4.2 V8 quattro	220	07/02 → 08/05	B	BAS
----------------	-----	---------------	---	-----

**Q7 I**

4.2 TDI	240	03/07 → 06/09	D	BTR
---------	-----	---------------	---	-----

**82047**
**350982047000**

**FLANGIA**

Numero Fori Flangia	4
Numero Fori Flangia (Serie 2)	2
Dimensione Fori Flangia	M6×1
Dimensione Fori Flangia (Serie 2)	Ø6
Posizione Attacco	90.6
Diametro Centraggio	Ø35
Diametro Girante	Ø82.2
N° Alette Girante	8
Posizione Girante	13.2

**KW**

**MERCEDES-BENZ**
**Classe G (W460, W461), Cabrio (W463)**

G 270 CDI	115	10/01 →	D	OM612.965
-----------	-----	---------	---	-----------

**Sprinter I (901, 902, 903, 904)**

208 CDI	60	04/00 → 05/06	D	OM611.987
211 CDI	80	04/00 → 05/06	D	OM611.981 → M: 107859
213 CDI	95	04/00 → 05/06	D	OM611.981
216 CDI	115	04/00 → 05/06	D	OM612.981 → 01-2004

**82047**
**350982047000**

**KW**

**MERCEDES-BENZ**
**Sprinter I (901, 902, 903, 904)**

308 CDI	60	04/00 → 05/06	D	OM611.987
308 D 2.3	60	02/95 → 04/00	D	OM601.943
311 CDI	80	04/00 → 05/06	D	OM611.981 → M: 107859
311 CDI 4x4	80	08/02 → 05/06	D	OM611.981 → M: 107859
313 CDI	95	04/00 → 05/06	D	OM611.981
313 CDI 4x4	95	08/02 → 05/06	D	OM611.981
316 CDI	115	04/00 → 05/06	D	OM612.981 → 01-2004
316 CDI 4x4	115	08/02 → 05/06	D	OM612.981 → 01-2004
408 CDI	60	04/00 → 05/06	D	OM611.987
411 CDI	80	04/00 → 05/06	D	OM611.981 → M: 107859
411 CDI 4x4	80	04/00 → 05/06	D	OM611.981 → M: 107859
413 CDI	95	04/00 → 05/06	D	OM611.981
413 CDI 4x4	95	04/00 → 05/06	D	OM611.981
416 CDI	115	04/00 → 05/06	D	OM612.981 → 01-2004
416 CDI 4x4	115	04/00 → 05/06	D	OM612.981 → 01-2004

**Sprinter II (905)**

616 CDI	115	04/01 → 05/06	D	OM612.981
---------	-----	---------------	---	-----------

**82048**
**350982048000**

**FLANGIA**

Numero Fori Flangia	4
Numero Fori Flangia	4
Dimensione Fori Flangia	M6×1
Posizione Attacco	65.2
Diametro Centraggio	Ø28
Diametro Girante	Ø59.5
N° Alette Girante	6
Posizione Girante	5

**KW**

**TOYOTA**
**Yaris I**

1.0 16V	48	03/03 → 09/05	B	1SZ-FE	Flange: 4 holes
	50	04/99 → 09/05	B	1SZ-FE	Flange: 4 holes

**Yaris II**

1.3 VVT-i	64	08/05 →	B	2NZ-FE, 2SZ-FE	Flange: 4 holes
-----------	----	---------	---	----------------	-----------------

**82049**
**350982049000**

FLANGIA	
Numero Fori Flangia	4
Dimensione Fori Flangia	M6x1
Posizione Attacco	52.3
Diametro Centraggio	Ø28
Diametro Girante	Ø56.1
N° Alette Girante	6
Posizione Girante	23.9

**CITROËN**
**C 4 Aircross**

1.6	86	04/12 →	B	4A92
-----	----	---------	---	------

**MITSUBISHI**
**ASX, Van**

1.6	85	05/10 →	B	4A92
	86	06/10 →	B	4A92

**Colt VI**

1.1	55	10/04 → 06/12	B	3A91
1.1 Bifuel	55	10/04 → 06/12	BF	3A91
1.3	70	06/04 → 06/12	B	4A90
1.3 Bifuel	70	06/04 → 06/12	BF	4A90
1.5	80	06/04 → 06/12	B	4A91

**Colt VII, CZC, Plus**

1.5	80	05/06 → 07/09	B	4A91
-----	----	---------------	---	------

**Lancer VIII, Station Wagon, Sportback**

1.5	80	06/08 →	B	4A91
-----	----	---------	---	------

**SMART**
**ForFour I**

1.1	47	02/05 → 06/06	B	M134.911
	55	01/04 → 06/06	B	M134.910
1.3	70	01/04 → 06/06	B	M135.930
1.5	80	01/04 → 06/06	B	M135.950
	90	01/04 → 06/06	B	M135.950
1.5 BRABUS	130	05/05 → 06/06	B	M122.950

**82050**
**350982050000**

FLANGIA	
Numero Fori Flangia	4
Dimensione Fori Flangia	M6x1
Posizione Attacco	80.1
Diametro Centraggio	Ø24
Diametro Girante	Ø57.5
N° Alette Girante	7
Posizione Girante	9.2

**SUZUKI**
**Grand Vitara I**

1.6 4x4	69	03/98 → 07/03	B	G16B
	73	02/00 → 09/02	B	G16B

**Grand Vitara II**

1.6 Trazione integrale	73	09/05 → 02/15	B	M16A
	78	04/05 →	B	M16A

**82051**
**350982051000**

PULEGGIA	
Diametro Puleggia	Ø60
Altezza Puleggia	36
Posizione Attacco	61.7
Diametro Girante	Ø72.1
N° Alette Girante	10
Posizione Girante	17.1

**LEXUS**
**RX I**

300	148	07/00 → 03/03	B	1MZ-FE
300 AWD	148	10/00 → 05/03	B	1MZ-FE
	164	07/00 → 05/03	B	1MZ-FE

**RX II**

300	150	05/03 → 12/08	B	1MZ-FE
330	171	04/03 → 01/06	B	3MZ-FE
330 AWD	171	04/03 → 12/08	B	3MZ-FE
400h	155	09/05 → 12/08		3MZ-FE
400h AWD	155	09/04 → 12/08		3MZ-FE

**TOYOTA**
**Camry III, Station Wagon**

3.0 24V	140	08/96 → 11/01	B	1MZ-FE
3.0 V6	135	08/96 → 11/01	B	1MZ-FE

**Camry IV**

3.0 V6	137	11/01 → 11/06	B	1MZ-FE
--------	-----	---------------	---	--------



**82052**
**350982052000**

**FLANGIA**

Numero Fori Flangia	4
Numero Fori Flangia (Serie 2)	2
Dimensione Fori Flangia	M6x1
Dimensione Fori Flangia (Serie 2)	Ø5.9
Posizione Attacco	90.9
Diametro Centraggio	Ø35
Diametro Girante	Ø78
N° Alette Girante	8
Posizione Girante	13.3

**KW**

**MERCEDES-BENZ**
**Sprinter III (906)**

209 CDI	65	06/06 →	D	OM646.984
211 CDI	80	06/06 →	D	OM646.985
213 CDI	95	06/06 →	D	OM646.986
215 CDI	110	06/06 →	D	OM646.986, OM646.989, OM646.990
	110	06/06 →	D	OM646.989, OM646.990
218 CDI	135	06/06 →	D	OM642.896, OM642.992, OM642.993
224	190	06/06 →	B	M272.979
309 CDI	65	06/06 →	D	OM646.984
311 CDI	80	06/06 →	D	OM646.985
311 CDI 4x4	80	02/08 →	D	OM646.985
313 CDI	95	06/06 →	D	OM646.986
	95	06/06 →	D	OM646.986, OM651.955
315 CDI	110	06/06 →	D	OM646.989, OM646.990
315 CDI 4x4	110	02/08 →	D	OM646.989, OM646.990
318 CDI	135	06/06 →	D	OM642.896, OM642.992, OM642.993
324	190	06/06 →	B	M272.979
411 CDI	80	06/09 →	D	OM646.985
415 CDI	110	06/06 →	D	OM646.989, OM646.990
509 CDI	65	06/06 →	D	OM646.984
511 CDI	80	06/06 →	D	OM646.985
511 CDI 4x4	80	06/06 →	D	OM646.985

**82052**
**350982052000**

**KW**

**MERCEDES-BENZ**
**Sprinter III (906)**

515 CDI	110	06/06 →	D	OM646.986, OM646.989, OM646.990
	110	06/06 →	D	OM646.989, OM646.990
515 CDI 4x4	110	06/06 →	D	OM646.989, OM646.990
518 CDI	135	06/06 →	D	OM642.896, OM642.992, OM642.993

**Sprinter IV Classic**

311 CDI	80	09/13 →	D	OM646.701
411 CDI	80	09/13 →	D	OM646.701

**Vito II (W639) - Viano**

109 CDI	65	09/03 →	D	OM646.983
	70	09/06 →	D	OM646.980
	70	08/06 →	D	OM646.980, OM646.981
109 CDI 4x4	70	09/07 →	D	OM646.981
111 CDI	80	09/03 →	D	OM646.982
	85	09/07 →	D	OM646.980, OM646.982
	85	09/07 →	D	OM646.980
111 CDI 4x4	80	09/07 →	D	OM646.982
115 CDI	110	09/03 →	D	OM646.980, OM646.982
	110	09/03 →	D	OM646.982
115 CDI 4x4	110	07/06 →	D	OM646.982
CDI 2.0	80	09/03 →	D	OM646.982
	85	08/05 →	D	OM646.982
CDI 2.0 4-matic	80	07/05 →	D	OM646.982
CDI 2.2	110	09/03 →	D	OM646.980, OM646.982
CDI 2.2 4-matic	110	07/05 →	D	OM646.982

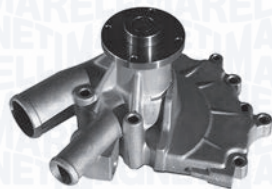
**82053**
**350982053000**

**FLANGIA**

Numero Fori Flangia	4
Dimensione Fori Flangia	M6×1
Posizione Attacco	106.2
Diametro Centraggio	Ø31.6
Diametro Girante	Ø74.7
N° Alette Girante	8
Posizione Girante	-1.8

**KW**

**NISSAN**
**Serena I**

2.3 D	55	01/95 → 09/01	D	LD23
-------	----	---------------	---	------

**Vanette III Cargo**

2.3 D	55	01/96 →	D	LD23
-------	----	---------	---	------

**82054**
**350982054000**

**FLANGIA**

Numero Fori Flangia	4
Dimensione Fori Flangia	M6×1
Posizione Attacco	105.8
Diametro Centraggio	Ø31.6
Diametro Girante	Ø74.2
N° Alette Girante	8
Posizione Girante	-1.1

**KW**

**NISSAN**
**Serena I**

2.0 D	49	11/92 → 09/01	D	LD20
-------	----	---------------	---	------

**Vanette II**

49	07/91 → 01/95	D	LD20II
----	---------------	---	--------

2.0 D	47	10/86 → 12/95	D	LD20
-------	----	---------------	---	------

49	10/86 → 12/95	D	LD20
----	---------------	---	------

**Vanette III Cargo**

2.0 D	49	01/96 →	D	LD20
-------	----	---------	---	------

**82055**
**350982055000**

**FLANGIA**

Numero Fori Flangia	4
Dimensione Fori Flangia	M8×1.25
Posizione Attacco	64.5
Diametro Mozzo	Ø28
Diametro Girante	Ø55
N° Alette Girante	7
Posizione Girante	24.5

**KW**

**LEXUS**
**HS**

250h	110	07/09 →	2AZ-FXE
------	-----	---------	---------

**TOYOTA**
**Avensis I, Liftback, Station Wagon**

2.0 VVT-i	110	10/00 → 02/03	B	1AZ-FSE
-----------	-----	---------------	---	---------

2.0	108	04/03 → 11/08	B	1AZ-FSE
-----	-----	---------------	---	---------

2.0 VVTi	114	04/03 → 11/08	B	1AZ-FE
----------	-----	---------------	---	--------

2.4	120	10/03 → 11/08	B	2AZ-FSE
-----	-----	---------------	---	---------

125	09/03 → 11/08	B	2AZ-FSE
-----	---------------	---	---------

**Avensis Verso**

2.0 VVT-i	110	08/01 → 11/09	B	1AZ-FE
-----------	-----	---------------	---	--------

2.4 VVTi GLS	115	10/03 → 11/09	B	2AZ-FE
-----------------	-----	---------------	---	--------

**Camry IV**

2.0 VVTi	110	08/01 → 11/06	B	1AZ-FE
----------	-----	---------------	---	--------

2.4 VVT-i	112	11/01 → 11/06	B	2AZ-FE
-----------	-----	---------------	---	--------

2.4 VVTi Hybrid	105	01/06 → 11/06	B	2AZ-FXE
--------------------	-----	---------------	---	---------

**Camry V**

2.4 VVTi	116	01/06 → 09/11	B	2AZ-FE
----------	-----	---------------	---	--------

123	01/06 → 09/11	B	2AZ-FE
-----	---------------	---	--------

**Previa II**

2.4	115	08/00 → 01/06	B	2AZ-FE
-----	-----	---------------	---	--------

2.4 4WD	96	07/02 → 12/05	B	2AZ-FXE
---------	----	---------------	---	---------

**Previa III**

2.4	125	10/05 →	B	2AZ-FE
-----	-----	---------	---	--------

**RAV 4 II**

2.0 VVTi 4WD	110	06/00 → 11/05	B	1AZ-FE
-----------------	-----	---------------	---	--------

2.4 VVTi 4WD	112	08/03 → 11/05	B	2AZ-FE
-----------------	-----	---------------	---	--------

**RAV 4 III**

2.0 VVT-i 4WD	112	03/06 →	B	1AZ-FE
------------------	-----	---------	---	--------

2.4 VVTi	125	11/05 →	B	2AZ-FE
----------	-----	---------	---	--------

2.4 VVTi 4WD	125	11/05 →	B	2AZ-FE
-----------------	-----	---------	---	--------

**82056**
**350982056000**

**PULEGGIA**

Diametro Puleggia	56.24
Numero Denti/Gole Puleggia	19
Altezza Puleggia	30
Posizione Attacco	62.2
Diametro Girante	71
N° Alette Girante	7
Posizione Girante	14

**KW**

**FORD**
**Focus II, Station Wagon, Cabrio**

2.5 RS	224	01/09 → 07/11	B	JZDA
2.5 RS 500	257	05/10 → 07/11	B	JZDA
2.5 ST	166	10/05 → 09/12	B	HYDA

**Kuga I**

2.5	147	03/09 → 11/12	B	HYDB, HYDC
2.5 4x4	147	03/09 →	B	HYDB

**Mondeo IV, Station Wagon**

2.5	162	03/07 → 09/14	B	HUBA
-----	-----	---------------	---	------

**S-Max**

2.5 ST	162	05/06 →	B	HUWA
--------	-----	---------	---	------

**RENAULT**
**Laguna I, Grantour**

2.0	103	06/95 → 02/01	B	N7Q700, N7Q704
2.0 16V	102	06/95 → 03/01	B	N7Q700, N7Q704

**VOLVO**
**850, Station Wagon**

2.0	93	08/94 → 12/96	B	B5202S
	105	06/91 → 12/96	B	B5204F
2.0 Turbo	132	09/93 → 10/96	B	B5204T2
	155	08/93 → 12/96	B	B5204FT, B5204T
2.3	106	01/96 → 10/96	B	B5234FS
2.3 T5	166	08/93 → 07/96	B	B5234FT
2.3 T5 R	176	04/96 → 10/96	B	B5234T2
	184	08/95 → 12/96	B	B5234T4
2.3 Turbo R	177	06/95 → 10/96	B	B5234T5
2.4 GLE	142	09/93 → 10/97	B	B5254T
2.5	103	06/91 → 07/94	B	B5252
	106	08/94 → 12/96	B	B5252FS
	125	08/91 → 12/96	B	B5254S
2.5 AWD	142	04/96 → 12/96	B	B5254T

**82056**
**350982056000**

**KW**

**VOLVO**
**C 30**

2.4 i	125	10/06 → 12/12	B	B5244S4
T5	162	10/06 → 12/12	B	B5254T3
	169	03/07 → 12/12	B	B5254T7

**C 70 I, Cabrio, Coupé**

2.0	132	03/98 → 10/05	B	B5204T2
2.0 T	120	03/00 → 10/05	B	B5204T4
	166	03/98 → 10/05	B	B5204T3
2.3 T5	176	03/98 → 10/05	B	B5234T3
	180	07/02 → 10/05	B	B5234T9
	176	03/97 → 09/02	B	B5234T3
2.4 T	147	07/02 → 10/05	B	B5244T7
2.5	121	03/99 → 09/02	B	B5254S
	125	05/99 → 09/02	B	B5244S, B5254S
	125	06/98 → 10/05	B	B5254S
2.5 T	142	03/98 → 10/05	B	B5244T, B5254T

**C 70 II**

2.4	103	03/06 → 10/09	B	B5244S5
2.4 i	125	03/06 → 10/09	B	B5244S4
T5	162	03/06 → 02/07	B	B5254T3
	169	03/07 → 10/09	B	B5254T7

**S 40 I**

1.6	80	03/99 → 12/03	B	B4164S2	
	77	09/95 → 08/99	B	B4164S	
1.8	85	07/95 → 08/99	B	B4184S, B4184S3	
	85	06/01 → 08/03		B4184S2	
	90	03/99 → 12/03	B	B4184S2, B4184S9	
1.8 i	90	06/01 → 12/03	B	B4184SJ	
1.9 T4	147	05/97 → 07/00	B	B4194T, B4194T2	
2.0	100	07/95 → 12/03	B	B4204S, B4204S2	11-1995→
	100	07/95 → 12/03	B	B4204S, B4204S2	
	103	07/95 → 08/99	B	B4204S	11-1995→
	103	07/95 → 08/99	B	B4204S	
2.0 T	118	10/97 → 12/03	B	B4204T	
	120	06/01 → 12/03	B	B4204T3	
	121	07/00 → 06/01	B	B4204T2, B4204T3	
2.0 T4	147	07/00 → 12/03	B	B4204T5	

**82056**
**350982056000**

**KW**

**VOLVO**
**S 40 II**

1.6	74	01/05 →	B	B4164S3
1.8	92	04/04 →	B	B4184S11
1.8 FlexFuel	92	01/06 →		B4184S8
2.4	103	01/04 →	B	B5244S5
	125	01/04 →	B	B5244S4
2.4 AWD	125	08/06 →	B	B5244S4
T5	162	01/04 →	B	B5254T3
	169	03/07 →	B	B5254T7
T5 AWD	162	04/04 →	B	B5254T3
T5 AWD	169	03/07 →	B	B5254T7

**S 60 I**

2.0 T	132	07/00 → 04/10	B	B5204T5
2.3 T5	195	07/00 → 09/02	B	B5234T7
2.4	103	11/00 → 04/10	B	B5244S2
	125	11/00 → 04/10	B	B5244S
2.4 AWD	191	02/04 → 04/10	B	B5244T5
2.4 Bifuel	103	06/02 → 04/10	BF	B5244SG
	103	06/02 → 04/10	BF	B5244SG2
2.4 T	147	11/00 → 04/10	B	B5244T3
2.4 T AWD	147	11/01 → 04/10	B	B5244T3
2.4 T5	191	04/04 → 04/10	B	B5244T5
2.5 T	154	02/04 → 04/10	B	B5254T2
2.5 T AWD	154	04/04 → 04/10	B	B5254T2
R2,5TAWD	221	03/03 → 04/10	B	B5254T4
T5	184	11/00 → 04/10	B	B5234T3

**S 60 II**

2.0 T	132	12/13 →	B	B5204T8
2.5 T5	186	09/11 →	B	B5254T5
2.5 T5 AWD	186	09/12 →	B	B5254T5

**S 70**

2.0	93	01/97 → 11/00	B	B5202FS, B5202S
	105	01/97 → 11/00	B	B5204F
	120	01/97 → 11/00	B	B5204T4
	132	01/97 → 11/00	B	B5204T2
2.0 Turbo	155	01/97 → 11/00	B	B5204T
	166	01/97 → 11/00	B	B5204T3
2.3	195	04/99 → 09/00	B	B5234T7
2.3 T-5	176	01/97 → 11/00	B	B5234T3
2.3 T5 AWD	177	11/96 → 09/98	B	B5234T3
	184	07/97 → 09/00	B	B5234T4
2.3 Turbo	184	01/97 → 11/00	B	B5234FT+

**82056**
**350982056000**

**KW**

**VOLVO**
**S 70**

2.4	103	08/99 → 11/00	B	B5244S2, B5244SG
	125	01/97 → 11/00	B	B5244S, B5254S
2.4 AWD	103	04/99 → 09/00	B	B5244S2
	106	11/96 → 05/99	B	B5252FS
	121	10/98 → 05/99	B	B5254S
	125	04/99 → 09/00	B	B5244S
2.4 Blu-Fuel	103	07/97 → 09/00	G	B5244S2, B5244SG
2.4 T5 AWD	142	11/96 → 04/99	B	B5254T
2.4 Turbo	142	01/97 → 11/00	B	B5244T, B5254T
2.5	106	01/97 → 11/00	B	B5252FS
	121	06/98 → 11/00	B	B5254S
2.5 Bifuel	103	07/99 → 11/00	BF	B5244SG
	106	10/98 → 11/00	BF	GB5252S

**S 80 I**

2.0	120	06/98 → 07/06	B	B5204T4
2.0 T	132	12/99 → 07/06	B	B5204T5
	166	06/98 → 07/06	B	B5204T3
2.4	103	01/99 → 07/06	B	B5244S2
	125	01/99 → 07/06	B	B5244S
2.4 Bifuel	103	09/01 → 07/06	BF	B5244SG
	103	09/01 → 07/06	BF	B5244SG2
2.4 LTP	132	06/04 → 07/06	B	B5244T4
2.4 T	147	06/00 → 07/06	B	B5244T3
2.4 T5 AWD	147	04/00 → 09/03	B	B5244T3
2.5 T	154	03/03 → 07/06	B	B5254T2
2.5 T AWD	154	07/03 → 07/06	B	B5254T2

**S 80 II**

2.5 T	183	09/12 →	B	B5254T14
	187	01/12 →	B	B5254T12
	147	03/06 →	B	B5254T6
	170	01/10 →	B	B5254T10
2.5 T AWD	147	10/06 →	B	B5254T6
2.5 T FlexFuel	147	05/08 →		B5254T8
	170	01/10 →		B5254T11

**V 40 I**

1.6	80	03/99 → 06/04	B	B4164S2
	77	12/95 → 08/99	B	B4164S
1.8	85	07/95 → 08/99	B	B4184S, B4184S3
	90	03/99 → 06/04	B	B4184S2, B4184S9

**82056**
**350982056000**

**VOLVO**
**V 40 I**

1.8 i	90	06/01 → 06/04	B	B4184SJ	
1.9 T4	147	05/97 → 07/00	B	B4194T	
2.0	100	07/95 → 06/04	B	B4204S, B4204S2	
	103	07/95 → 08/99	B	B4204S	
2.0 T	118	10/97 → 07/00	B	B4204T	
	120	06/01 → 06/04	B	B4204T3	
	121	07/99 → 06/04	B	B4204T2	
2.0 T4	147	07/00 → 06/04	B	B4204T5	

**V 40 II**

T4	132	07/13 →	B	B5204T8	
T4 AWD	132	07/13 →	B	B5204T8	
T5	157	03/13 →	B	B5204T9	
	183	01/14 →	B	B5254T14	
	187	12/12 →	B	B5254T12	
T5 AWD	157	03/13 →	B	B5204T9	
	187	01/13 →	B	B5254T12	

**V 50**

2.4	103	04/04 →	B	B5244S5	
	125	04/04 →	B	B5244S4	
2.4 AWD	125	08/06 →	B	B5244S4	
T5	162	04/04 →	B	B5254T3	
	169	03/07 →	B	B5254T7	
T5 AWD	162	04/04 →	B	B5254T3	
	169	03/07 →	B	B5254T7	

**V 60**

T5	157	04/14 →	B	B5204T9	
----	-----	---------	---	---------	--

**V 70 I**

2.0	93	01/97 → 03/00	B	B5202S	
	105	01/97 → 03/00	B	B5204F	11-1996 →
	105	01/97 → 03/00	B	B5204F	
	120	01/97 → 03/00	B	B5204T4	
	132	01/97 → 03/00	B	B5204T2	
2.0 Turbo	155	01/97 → 03/00	B	B5204T	
	166	01/97 → 03/00	B	B5204T3	
2.0 Turbo AWD	166	01/97 → 03/00	B	B5204T3	
2.3	177	11/96 → 11/00	B	B5234T3	
2.3 AWD	177	04/97 → 09/98	B	B5234T3	
	195	12/98 → 02/00	B	B5234T7, B5234T8	
2.3 T AWD	184	04/97 → 03/00	B	B5234FT+, B5234T4	
2.3 T-5	176	01/97 → 03/00	B	B5234T3	

**82056**
**350982056000**

**VOLVO**
**V 70 I**

2.3 T-5 AWD	176	01/97 → 03/00	B	B5234T3	
2.3 Turbo	184	01/97 → 03/00	B	B5234FT+	
2.4	103	08/99 → 05/00	B	B5244S2, B5244SG2	
	125	01/97 → 05/00	B	B5244S, B5254S	
2.4 AWD	121	10/98 → 05/99	B	B5254S	
2.4 Bifuel	103	08/99 → 03/00	BF	B5244SG	
2.4 Turbo	142	01/97 → 03/00	B	B5244T, B5254T	
2.5	106	01/97 → 03/00	B	B5252FS	
	121	06/98 → 03/00	B	B5254S	
2.5 AWD	195	03/99 → 03/00	B	B5244T2	
2.5 Bifuel	106	10/98 → 08/99	BF	GB5252S	
2.5 Turbo AWD	142	01/97 → 05/00	B	B5244T, B5254T	

**V 70 II**

2.0 T	132	07/01 → 08/07	B	B5204T5	
2.3	195	10/00 → 09/04	B	B5234T7	
2.3 AWD	195	10/00 → 09/04	B	B5234T7, B5234T8	
2.3 T5	184	03/00 → 08/04	B	B5234T3, B5234T4	
2.4	103	03/00 → 08/07	B	B5244S2	
	121	03/00 → 09/03	B	B5254S	
	125	03/00 → 08/07	B	B5244S	
2.4 Bifuel	103	09/01 → 08/07	BF	B5244SG, B5244SG2	
	103	09/01 → 08/07	BF	B5244SG2	
2.4 T	147	03/00 → 08/03	B	B5244T3	
2.4 T AWD	147	09/01 → 08/02	B	B5244T3	
2.4 T5	191	04/04 → 08/07	B	B5244T5	
2.5 R Sport	221	12/02 → 08/07	B	B5254T4	
2.5 T	154	04/04 → 08/07	B	B5254T2	
2.5 T AWD	154	09/02 → 08/07	B	B5254T2	
R2,5 T AWD	221	03/03 → 08/07	B	B5254T4	

**V 70 III**

2.0 BiFuel	157	03/13 →	BF	B5204T9	
2.5 T	147	08/07 →	B	B5254T6	
	170	01/10 →	B	B5254T10	
2.5 T FlexiFuel	147	05/08 →		B5254T8	
2.5 T FlexiFuel	170	10/09 →		B5254T11	

## 82056 350982056000



### VOLVO

#### XC 60

2.4 D / D3 / D4 AWD	120	05/08 →	D	D5244T16, D5244T17, D5244T5
D5 AWD	136	05/08 →	D	D5244T4
T5 AWD	187	04/14 →	B	B5254T12

#### XC 70 I Cross Country

2.4 T XC AWD	142	11/97 → 09/02	B	B5254T
	147	03/00 → 09/02	B	B5244T3
2.5 T XC AWD	154	09/02 → 08/07	B	B5254T2

#### XC 70 II

T5 AWD	187	08/15 →	B	B5254T12
--------	-----	---------	---	----------

#### XC 90 I

2.5 T	154	10/02 →	B	B5254T2
-------	-----	---------	---	---------

## 82057 350982057000



### PULEGGIA

Diametro Puleggia	Ø137.5
Numero Denti/Gole Puleggia	7
Altezza Puleggia	27.3
Posizione Attacco	130.9
Diametro Girante	Ø78.6
N° Alette Girante	8
Posizione Girante	12.1



### FORD

#### Transit VII

	55	01/00 → 05/06	D	F4FA
2.4 DI	66	01/00 → 05/06	D	D2FA, D2FB, D2FE
	88	01/00 → 05/06	D	D4FA
2.4 DI [RWD]	55	01/00 → 05/06	D	F4FA
	88	01/00 → 05/06	D	D4FA
2.4 TD	55	08/00 → 08/03	D	F4FA
2.4 TDCi	101	03/04 → 05/06	D	H9FA
2.4 TDdi	66	10/01 → 03/06	D	D2FE
	88	08/00 → 08/03	D	D4FA
2.4 TDE	85	03/04 → 05/06	D	FXFA
	92	07/01 → 05/06	D	DOFA
	92	07/01 → 05/06	D	DOFA

## 82057 350982057000



### FORD

#### Transit XIII

2.4 TDCi	74	04/06 → 08/14	D	PHFA, PHFC
	85	04/06 → 08/14	D	JXFA, JXFC
	103	04/06 → 08/14	D	H9FD
2.4 TDCi [RWD]	74	04/06 → 08/14	D	PHFA, PHFC
	85	04/06 → 08/14	D	JXFA, JXFC
	103	04/06 → 08/14	D	H9FB, H9FD
2.4 TDCi 4x4	103	04/06 → 08/14	D	H9FD
	103	11/06 → 08/14	D	H9FB

### LAND ROVER

#### Defender Cabrio, Station Wagon, Pickup

2.4 Td4 4x4	90	05/07 →	D	ZSD-424
-------------	----	---------	---	---------

## 82058 350982058000



### PULEGGIA

Diametro Puleggia	Ø88
Numero Denti/Gole Puleggia	7
Altezza Puleggia	26.4
Posizione Attacco	92
Diametro Girante	Ø71.6
N° Alette Girante	6
Posizione Girante	11.8



### CHRYSLER

#### 300 C, Touring

3.0 CRD	160	09/05 → 11/12	D	EXL
---------	-----	---------------	---	-----

### JEEP

#### Commander

3.0 CRD 4x4	160	04/06 → 12/10	D	EXL
-------------	-----	---------------	---	-----

#### Grand Cherokee III

3.0 CRD 4x4	155	05/06 → 12/10	D	EXL
	160	06/05 → 12/10	D	EXL

### MERCEDES-BENZ

#### Classe C II (W203), Station Wagon (S203), Coupé (CL203)

C 320 CDI	165	01/05 → 02/07	D	OM642.910
-----------	-----	---------------	---	-----------

#### Classe C III (W204), Station Wagon (S204), Coupé (C204)

C 300 CDI 4-matic	170	01/11 → 01/14	D	OM642.832
C 320 CDI	165	01/07 → 01/14	D	OM642.960

**82058**
**350982058000**

**KW**

**MERCEDES-BENZ**
**Classe C III (W204), Station Wagon (S204), Coupé (C204)**

C 320 CDI 4-matic	165	07/07 → 01/14	D	OM642.961
	165	08/07 → 08/14	D	OM642.830
C 350 CDI	165	07/09 → 01/14	D	OM642.960
	170	10/09 → 01/14	D	OM642.830
C 350 CDI 4-matic	165	07/09 → 01/14	D	OM642.961
	170	10/09 → 01/14	D	OM642.832

**Classe E III (W211), Station Wagon (S211)**

E 280 CDI	140	03/05 → 12/08	D	OM642.920
E 280 CDI 4-matic	140	03/05 → 12/08	D	OM642.921
E 280 T CDI	140	03/05 → 07/09	D	OM642.920
E 280 T CDI 4-matic	140	03/05 → 07/09	D	OM642.921
E 300 BlueTEC	155	09/07 → 12/08	D	OM642.920
E 320 CDI	165	03/05 → 12/08	D	OM642.920
E 320 CDI 4-matic	165	03/05 → 12/08	D	OM642.910
E 320 T CDI	165	03/05 → 07/09	D	OM642.920
E 320 T CDI 4-matic	165	03/05 → 07/09	D	OM642.920

**Classe E IV (W212), Station Wagon (S212), Cabrio (A207), Coupé (C207)**

E 300 CDI	150	12/09 → 12/10	D	OM642.850
E 300 CDI / BlueTEC	170	03/11 →	D	OM642.850, OM642.852
E 350 BlueTEC	155	01/09 →	D	OM642.850
E 350 CDI	170	01/10 →	D	OM642.836
	170	01/09 →	D	OM642.850
	170	11/09 →	D	OM642.850, OM642.852
E 350 CDI 4-matic	170	09/09 →	D	OM642.856

**Classe G (W460, W461), Cabrio (W463)**

G 280 CDI	135	04/09 →	D	OM642.884
G 300 CDI	135	04/10 →	D	OM642.884
G 350 CDI	155	07/11 →	D	OM642.886
G 350 d	180	06/15 →	D	OM642.887

**82058**
**350982058000**

**KW**

**MERCEDES-BENZ**
**Classe GL I (X164)**

GL 320 CDI / 350 BlueTEC 4-matic	155	12/09 →	D	OM642.820
GL 350 CDI 4-matic	195	10/10 →	D	OM642.822

**Classe GL II (X166)**

GL 350 CDI / BlueTEC 4-matic	190	07/12 →	D	OM642.826
------------------------------	-----	---------	---	-----------

**Classe GLK (X204)**

320 CDI 4-matic	165	06/08 →	D	OM642.961
350 CDI 4-matic	165	07/09 → 01/10	D	OM642.832
	170	02/10 → 05/10	D	OM642.832

**Classe M II (W164)**

ML 300 CDI 4-matic	150	02/10 →	D	OM642.820
ML 350 CDI 4-matic	155	09/09 →	D	OM642.820

**Classe M III (166)**

ML 350 BlueTEC 4-matic	190	06/11 →	D	OM642.826
------------------------	-----	---------	---	-----------

**Classe R (W251, V251)**

R 280 CDI	140	05/06 →	D	OM642.870, OM642.872, OM642.950	→ 10-2007
R 280 CDI 4-matic	140	05/06 →	D	OM642.950	→ 10-2007
R 320 CDI 4-matic	155	01/06 →	D	OM642.870, OM642.950	
	165	01/06 →	D	OM642.950	→ 10-2007

**Classe S VI (W221), Coupé (C216)**

S 320 CDI	155	10/05 → 12/13	D	OM642.930
S 320 CDI 4-matic	155	10/05 → 12/13	D	OM642.932
S 350 BlueTec	190	04/11 → 12/13	D	OM642.862
S 350 BlueTEC 4-matic	190	04/11 → 12/13	D	OM642.868
S 350 CDI	173	06/09 → 12/13	D	OM642.930

**82058**
**350982058000**

**MERCEDES-BENZ**
**CLK II (C209), Cabrio (A209)**

320 CDI	165	01/05 → 05/09	D	OM642.910
CLK 320 CDI	165	03/05 → 03/10	D	OM642.910

**CLS I (C219)**

CLS 320 CDI	155	01/05 → 12/10	D	OM642.920
CLS 350 CDI	200	04/09 → 12/10	D	OM642.920
CLS 350 CDI	165	04/09 → 12/10	D	OM642.920

**Sprinter III (906)**

218 CDI	135	06/06 →	D	OM642.896, OM642.992
219 CDI / BlueTEC	140	03/09 →	D	OM642.896, OM642.992
318 CDI	135	02/08 →	D	OM642.896, OM642.992, OM642.993
318 CDI 4x4	135	02/08 →	D	OM642.896, OM642.992, OM642.993
319 CDI / BlueTEC	140	03/09 →	D	OM642.896, OM642.898, OM642.992
319 CDI / BlueTEC 4x4	140	03/09 →	D	OM642.896, OM642.898, OM642.992
418 CDI	135	06/09 →	D	OM642.896, OM642.992
	135	06/06 →	D	OM642.896, OM642.992, OM642.993
419 CDI	140	03/09 →	D	OM642.896, OM642.898, OM642.992
	140	03/09 →	D	OM642.992
518 CDI	135	06/06 →	D	OM642.896, OM642.992, OM642.993
518 CDI 4x4	135	06/06 →	D	OM642.896, OM642.992, OM642.993
519 CDI / BlueTEC	140	03/09 →	D	OM642.896, OM642.898, OM642.992
519 CDI / BlueTEC 4x4	140	03/09 →	D	OM642.896, OM642.898, OM642.992

**82058**
**350982058000**

**MERCEDES-BENZ**
**Vito II (W639) - Viano**

120 CDI	150	07/06 →	D	OM642.990
	165	09/10 →	D	OM642.890
CDI 3.0	150	03/06 →	D	OM642.990
	165	07/10 →	D	OM642.990

**82059**
**350982059000**

**PULEGGIA**

Diametro Puleggia	Ø88
Numero Denti/Gole Puleggia	8
Altezza Puleggia	29.9
Posizione Attacco	62
Diametro Girante	Ø71.5
N° Alette Girante	6
Posizione Girante	11.4

**MERCEDES-BENZ**
**Classe G (W460, W461), Cabrio (W463)**

G 320 CDI	165	09/06 →	D	OM642.970
-----------	-----	---------	---	-----------

**Classe GL I (X164)**

GL 320 CDI 4-matic	165	09/06 → 05/09	D	OM642.940
GL 350 CDI 4-matic	165	05/09 →	D	OM642.940

**Classe M II (W164)**

ML 280 CDI 4-matic	140	07/05 → 07/09	D	OM642.940
ML 300 CDI 4-matic	140	07/09 →	D	OM642.940
ML 320 CDI 4-matic	165	07/05 → 07/09	D	OM642.940
ML 350 CDI 4-matic	165	07/09 →	D	OM642.940
	170	02/10 →	D	OM642.820

**Classe R (W251, V251)**

R 280 CDI	140	05/06 →	D	OM642.870, OM642.872, OM642.950	11-2007 →
R 280 CDI 4-matic	140	05/06 →	D	OM642.950	11-2007 →
R 300 CDI	140	07/09 →	D	OM642.870, OM642.872, OM642.950	
R 300 CDI 4-matic	140	07/09 →	D	OM642.950	



**82059 350982059000**

**MERCEDES-BENZ**
**Classe R (W251, V251)**

R 320 CDI 4-matic	165	01/06 →	D	OM642.950	11-2007 →
----------------------	-----	---------	---	-----------	-----------

R 350 CDI 4-matic	155	01/06 →	D	OM642.870, OM642.950	
	165	07/09 →	D	OM642.950	

**Classe S VI (W221), Coupé (C216)**

S 320 CDI	173	12/05 → 06/09	D	OM642.930	
-----------	-----	---------------	---	-----------	--

S 320 CDI 4-matic	173	10/06 → 12/13	D	OM642.932	
----------------------	-----	---------------	---	-----------	--

**82063 350982062300**

**PULEGGIA**

Diametro Puleggia	Ø99
Altezza Puleggia	30
Posizione Attacco	39.4
Diametro Girante	Ø44.8
N° Alette Girante	6
Posizione Girante	21.4

**CITROËN**
**C 1 I**

1.0	50	06/05 →	B	1KR-FE	
-----	----	---------	---	--------	--

**DAIHATSU**
**Cuore XIII**

1.0	51	04/07 →	B	1KR-FE	
-----	----	---------	---	--------	--

**Sirion II**

1.0	51	01/05 →	B	1KR-FE	
-----	----	---------	---	--------	--

1.0 DVVT 4WD	51	04/05 →	B	1KR-FE	
-----------------	----	---------	---	--------	--

**Storia**

1.0	51	04/05 →	B	1KR-FE	
-----	----	---------	---	--------	--

**PEUGEOT**
**107**

1.0	50	06/05 →	B	1KR (384F), CFA (384F)	
-----	----	---------	---	---------------------------	--

**SUBARU**
**Justy IV**

1.0	51	01/07 →	B	1KR-FE	
-----	----	---------	---	--------	--

**TOYOTA**
**Aygo I**

1.0	50	07/05 →	B	1KR-FE	
-----	----	---------	---	--------	--

1.0 GPL	50	07/05 →		1KR-FE	
---------	----	---------	--	--------	--

**82063 350982062300**

**TOYOTA**
**Yaris II**

1.0	52	08/07 →	B	1KR-FE	
-----	----	---------	---	--------	--

1.0 GPL	51	01/06 →		1KR-FE	
---------	----	---------	--	--------	--

1.0 VVT-i	51	08/05 →	B	1KR-FE	
-----------	----	---------	---	--------	--

**Yaris III**

1.0	51	09/11 →	B	1KR-FE	
-----	----	---------	---	--------	--

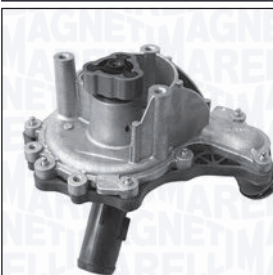
**82066 350982066000**

**FLANGIA**

Numero Fori Flangia	1
Dimensione Fori Flangia	M8×1.25
Posizione Attacco	71.6
Diametro Girante	Ø94.5
N° Alette Girante	5
Posizione Girante	17.7

**CITROËN**
**Jumper III**

2.2 HDi 100	74	04/06 →	D	4HV (P22DTE)	
-------------	----	---------	---	-----------------	--

2.2 HDi 120	88	04/06 →	D	4HU (P22DTE)	
-------------	----	---------	---	-----------------	--

2.2 HDi 150	110	07/11 →	D	4HJ (P22DTE)	
-------------	-----	---------	---	-----------------	--

**FIAT**
**Ducato V**

100 Multijet 2,2 D	74	07/06 →	D	4HV	
-----------------------	----	---------	---	-----	--

**FORD**
**Tourneo II Connect, Courier, Custom**

	74	04/12 →	D	DRF4, DRFF, DRFG	
--	----	---------	---	---------------------	--

2.2 TDCi	92	04/12 →	D	CYF4, CYFF	
----------	----	---------	---	---------------	--

	114	04/12 →	D	CVFF	
--	-----	---------	---	------	--

**Transit Custom**

	74	04/12 →	D	DRF4, DRFF, DRFG	
--	----	---------	---	---------------------	--

2.2 TDCi	92	04/12 →	D	CYF4, CYFF	
----------	----	---------	---	---------------	--

	114	04/12 →	D	CVFF	
--	-----	---------	---	------	--

**82066**
**350982066000**

**KW**

**FORD**
**Transit Tourneo II**

2.2 TDCi	81	07/06 → 08/14	D	QVFA
	85	10/08 → 08/14	D	SRFA, SRFB, SRFC, SRFD, SRFE
	96	07/06 → 08/14	D	QWFA
	103	10/07 → 08/14	D	PGFA, PGFB, UHFA, UHFB

**Transit XIII**

2.2 TDCi	63	04/06 → 08/14	D	P8FA, P8FB
	74	10/11 → 08/14	D	DRFA, DRFB, DRFC, DRFD, DRFE
	81	04/06 → 08/14	D	QVFA
	85	10/08 → 08/14	D	SRFA, SRFB, SRFC, SRFD, SRFE
	92	10/11 → 08/14	D	CYFA, CYFB, CYFC, CYFD
	96	04/06 → 08/14	D	QWFA
	103	10/07 → 08/14	D	PGFA, PGFB, UHFA, UHFB, UHFC

**PEUGEOT**
**Boxer III**

2.2 HDi 100	74	04/06 →	D	4HV (P22DTE)
2.2 HDi 110	81	03/11 →	D	4HG (P22DTE)
2.2 HDi 120	88	04/06 →	D	4HU (P22DTE)
2.2 HDi 130	96	03/11 →	D	4HH (P22DTE)
2.2 HDi 150	110	03/11 →	D	4HJ (P22DTE)

**82067**
**350982067000**

**KW**

**FLANGIA**

Numero Fori Flangia	3
Numero Fori Flangia (Serie 2)	3
Dimensione Fori Flangia	M8×1.25
Dimensione Fori Flangia (Serie 2)	7×12.5
Posizione Attacco	81
Diametro Centraggio	Ø28
Diametro Girante	Ø65
N° Alette Girante	7
Posizione Girante	30

**CITROËN**
**C 5 III, Break**

2.7 HDi	150	02/08 →	D	DT17ED4
	150	02/08 →	D	DT17ED4, UHZ (DT17BTED4)

**C 6**

2.7 HDi	150	09/05 →	D	DT17ED4, UHZ (DT17BTED4)
---------	-----	---------	---	--------------------------

**PEUGEOT**
**407, Station Wagon, Coupé**

2.7 HDi	150	10/05 →	D	UHZ (DT17)
---------	-----	---------	---	------------

**607**

2.7 HDi 24V	150	12/04 →	D	DT17TED4
-------------	-----	---------	---	----------

**82068**
**350982068000**

**KW**

**PULEGGIA**

Diametro Puleggia	Ø56.2
Numero Denti/Gole Puleggia	19
Altezza Puleggia	32.2
Posizione Attacco	41.5
Diametro Girante	Ø90.5
N° Alette Girante	8
Posizione Girante	34.5

**CITROËN**
**C 4 II, Picasso, Grand Picasso**

2.0 BlueHDi 135	100	09/13 →	D	AHV (DW10FDD)
2.0 BlueHDi 150	110	09/13 →	D	AHX (DW10FD)

**82068 350982068000**

**KW**

**CITROËN**
**C 5 II, Break**

2.2 HDi	120	05/06 →	D	4HP (DW12BTED4), 4HR (DW12BTED4)
	125	04/06 →	D	4HT (DW12BTED4)

**C 5 III, Break**

2.0 HDi 150 / BlueHDi 150	110	04/09 →	D	AHR (DW10FD), RHE (DW10CTED4)
2.0 HDi 180	133	03/15 →	D	AHW (DW10FC)
2.2 HDi	125	02/08 →	D	4HT (DW12BTED4)
2.2 HDi 165	120	02/08 →	D	4HP (DW12BTED4)
2.2 HDi 200	150	07/10 →	D	4HL (DW12C)

**C 6**

2.2 HDi	120	06/06 →	D	4HP (DW12BTED4)
	125	06/06 →	D	4HT (DW12BTED4)

**C 8**

2.2 HDi	120	06/07 →	D	4HP (DW12BTED4), 4HR (DW12BTED4)
	125	06/06 →	D	4HT (DW12BTED4)

**C-Crosser**

2.2 HDi	115	02/07 →	D	4HN (DW12MTED4)
---------	-----	---------	---	--------------------

**DS 5**

2.0 BlueHDi 180	133	08/13 → 07/15	D	AHW (DW10FC)
--------------------	-----	---------------	---	-----------------

**DS**
**DS 4 / DS 4 CROSSBACK**

2.0 BlueHDi 150	110	07/15 →	D	
2.0 BlueHDi 180	133	07/15 →	D	

**82068 350982068000**

**KW**

**DS**
**DS5**

2.0 BlueHDi 150	110	04/15 →	D	
2.0 BlueHDi 180	133	04/15 →	D	

**FIAT**
**Ulysse II**

2.2 D Multijet	125	03/08 → 06/11	D	4HS, 4HT (DW12BTED4)
2.2 JTD	120	03/08 → 06/11	D	4HP, 4HR

**FORD**
**C-Max II, Van**

2.0 TDCi	110	03/15 →	D	T7DB
	125	03/15 →	D	T8DE

**Focus III, Station Wagon, Van**

2.0 TDCi	110	11/14 →	D	T7DB
	136	11/14 →	D	T8DA

**Galaxy II**

2.2 TDCi	129	03/08 → 12/12	D	Q4BA, Q4WA
	147	11/10 → 06/15	D	KNWA

**Galaxy III**

2.0 TDCi	110	01/15 →	D	T7CI, T7CJ, T7CK, T7CL
	132	01/15 →	D	T8CG, T8CH, T8CI, T8CJ
2.0 TDCi 4x4	110	05/15 →	D	
	132	05/15 →	D	T8CG, T8CH, T8CI, T8CJ
2.0 TDCi Bi-Turbo	154	01/15 →	D	T9CB, T9CC

**Kuga II, Van**

2.0 TDCi 4x4	132	09/14 →	D	T8MA, T8MB
--------------	-----	---------	---	------------

**Mondeo IV, Station Wagon**

2.2 TDCi	129	03/08 → 10/10	D	Q4BA
	147	07/10 → 09/14	D	KNBA

**Mondeo V, Station Wagon**

2.0 TDCi	110	09/14 →	D	T7CE
	132	09/14 →	D	T8CC
2.0 TDCi 4x4	110	02/15 →	D	T7CE
	132	02/15 →	D	T8CC
2.0 TDCi Bi-Turbo	154	03/15 →	D	T9CA
	154	05/15 →	D	

**82068**
**350982068000**

**KW**

**FORD**
**S-Max**

2.0 TDCi	110	02/15 →	D	T7CI, T7CJ, T7CK, T7CL
	132	02/15 →	D	T8CG, T8CH, T8CI, T8CJ
2.0 TDCi 4x4	110	02/15 →	D	T7CI, T7CJ, T7CK, T7CL
	132	02/15 →	D	T8CG, T8CH, T8CI, T8CJ
2.0 TDCi BI-Turbo	154	02/15 →	D	T9CB, T9CC
2.2 TDCi	129	03/08 →	D	Q4WA
	147	07/10 →	D	KNWA

**JAGUAR**
**XF I**

2.2 D	120	04/11 → 04/15	D	224DT
	140	05/11 → 04/15	D	224DT
	147	03/12 → 04/15	D	224DT

**XF II, Sportbrake**

2.2 D	120	09/12 → 04/14	D	224DT
	147	09/12 → 04/14	D	224DT

**LANCIA**
**Phedra**

2.2 D Multijet	125	03/08 → 11/10	D	4HS, 4HT
2.2 JTD	120	04/06 → 11/10	D	4HP, 4HR

**LAND ROVER**
**Discovery Sport**

2.2 D 4WD	110	12/14 →	D	224DT
	140	12/14 →	D	224DT

**Freelander II**

2.2 eD4	110	08/10 → 10/14	D	224DT, (DW12BTED4)
2.2 SD4 4x4	140	08/10 → 10/14	D	224DT
2.2 TD4 4x4	110	10/06 → 10/14	D	224DT, DW12BTED4
	112	01/07 → 10/14	D	224DT
	115	10/06 → 10/14	D	224DT
	118	10/06 → 10/14	D	224DT, DW12BTED4

**Range Rover Evoque, Cabrio**

2.2 D	110	06/11 →	D	224DT
2.2 D 4x4	110	06/11 →	D	224DT
	140	06/11 →	D	224DT

**82068**
**350982068000**

**KW**

**MITSUBISHI**
**Outlander II, Van**

2.2 DI-D 4WD	115	08/07 → 11/12	D	4HK, 4HN
-----------------	-----	---------------	---	----------

**PEUGEOT**
**308 II Station Wagon**

2.0 BlueHdi 150	110	11/13 →	D	
	110	03/14 →	D	
2.0 GT BlueHdi 180	133	06/14 →	D	
2.0 GT HDi 180	133	06/14 →	D	

**407, Station Wagon, Coupé**

2.2 HDi	120	06/08 →	D	4HP (DW12BTED4)
2.2 HDi 170	125	05/06 →	D	4HT (DW12BTED4)

**508, Station Wagon**

2.0 BlueHdi 150	110	04/14 →	D	AHX (DW10FD)
2.0 BlueHdi 180	133	04/14 →	D	AHW (DW10FC)
2.0 HDi 180 RXH	133	10/14 →		
2.2 HDi	150	11/10 →	D	4HL (DW12C)

**607**

2.2 HDi	125	05/06 →	D	4HT (DW12BTED4)
---------	-----	---------	---	--------------------

**807**

2.2 HDi	120	06/06 →	D	4HT (DW12BTED4)
	125	06/06 →	D	4HT (DW12BTED4)

**4007**

2.2 HDi	115	02/07 →	D	4HK (DW12MTED4), 4HN (DW12MTED4)
---------	-----	---------	---	---

**82069**
**350982069000**

**FLANGIA**

Numero Fori Flangia	3
Dimensione Fori Flangia	M8x1.25
Posizione Attacco	43.6
Diametro Centraggio	Ø28.3
Diametro Girante	Ø67.2
N° Alette Girante	16
Posizione Girante	55

**KW**

**NISSAN**
**Primastar**

dCi 120	84	09/06 →	D	M9R780
dCi 90	66	09/06 →	D	M9R782

**Qashqai I**

2.0 dCi	110	02/07 →	D	M1D, M9R
2.0 dCi Trazione integrale	110	02/07 →	D	M1D, M9R

**X-Trail II**

2.0 dCi	110	06/07 → 11/13	D	M9R
	127	06/07 → 11/13	D	M9R760
2.0 dCi FWD	110	06/07 → 11/13	D	M9R

**OPEL**
**Movano B**

2.3 CDTI	74	12/10 →	D	M9T670, M9T672, M9T676
	92	12/10 →	D	M9T670, M9T672, M9T676, M9T680, M9T876
	107	12/10 →	D	M9T678, M9T680
	110	01/13 →	D	M9T880
2.3 CDTI [RWD]	74	05/10 →	D	M9T690, M9T692
	92	05/10 →	D	M9T692, M9T696, M9T698, M9T876
	107	05/10 →	D	M9T694, M9T696, M9T698

**82069**
**350982069000**

**KW**

**OPEL**
**Movano B**

2.3 CDTI FWD	74	05/10 →	D	M9T670, M9T672, M9T676
	92	05/10 →	D	M9T670, M9T672, M9T676, M9T680, M9T876
	92	05/10 →	D	M9T670, M9T672, M9T676, M9T876
	107	05/10 →	D	M9T678, M9T680
	110	01/13 →	D	M9T880

**Vivaro**

2.0 CDTI	66	08/06 →	D	M9R630, M9R780, M9R782, M9R786
	66	08/06 →	D	M9R780, M9R782, M9R786
	84	08/06 →	D	M9R630, M9R692, M9R780, M9R784, M9R786, M9R788
	84	08/06 →	D	M9R630, M9R780
	84	08/06 →	D	M9R692, M9R780, M9R784, M9R786, M9R788

**RENAULT**
**Espace IV**

2.0 dCi	96	01/06 →	D	M9R740, M9R750, M9R760, M9R761, M9R762, M9R763
	110	01/06 →	D	M9R740, M9R750, M9R815
	127	01/06 →	D	M9R760, M9R761, M9R762, M9R763, M9R815

**82069**
**350982069000**

**RENAULT**
**Grand Scénic II**

2.0 dCi	110	09/05 →	D	M9R700, M9R721, M9R722
---------	-----	---------	---	------------------------------

**Grand Scénic III**

2.0 dCi	110	02/09 →	D	M9R615
	118	04/09 →	D	M9R610

**Koleos**

2.0 dCi	110	09/08 →	D	M9R855, M9R856, M9R862, M9R865, M9R866
	130	09/08 →	D	M9R830

2.0 dCi 4x4	110	09/08 →	D	M9R832, M9R855, M9R856, M9R862, M9R865, M9R866
	127	09/08 →	D	M9R830

**Laguna II, Grantour**

2.0 dCi	110	08/05 →	D	M9R740
	127	01/06 →	D	M9R760

**Laguna III, Grantour, Coupé**

2.0 dCi	127	09/08 →	D	M9R800, M9R809, M9R815
	96	10/07 →	D	M9R742, M9R744, M9R802
	110	09/08 →	D	M9R802, M9R805, M9R814
	127	01/08 →	D	M9R800, M9R809, M9R815
2.0 dCi GT	131	03/08 →	D	M9R816
	131	09/08 →	D	M9R816, M9R820
3.0 dCi	177	01/12 →	D	V9X891
	173	09/08 →	D	V9X791, V9X891

**Latitude**

2.0 dCi 150	110	02/11 →	D	M9R824, M9R846
2.0 dCi 175	127	05/11 →	D	M9R804, M9R817, M9R844
3.0 dCi 240	177	02/11 →	D	V9X891

**82069**
**350982069000**

**RENAULT**
**Master III**

2.3 dCi 100 FWD	74	02/11 →	D	M9T670, M9T672, M9T676, M9T870
-----------------	----	---------	---	---

2.3 dCi 125 FWD	92	02/11 →	D	M9T670, M9T672, M9T676, M9T870
-----------------	----	---------	---	---

2.3 dCi 150	110	10/12 →	D	M9T880
-------------	-----	---------	---	--------

2.3 dCi FWD	110	03/13 →	D	M9T880, M9T898
-------------	-----	---------	---	-------------------

2.3 dCi FWD	74	02/10 →	D	M9T670, M9T672, M9T676, M9T870, M9T890
-------------	----	---------	---	--

2.3 dCi FWD	92	02/10 →	D	M9T670, M9T672, M9T676, M9T696, M9T698, M9T870, M9T890, M9T896
-------------	----	---------	---	---

2.3 dCi FWD	92	02/10 →	D	M9T670, M9T672, M9T676, M9T698, M9T870, M9T890, M9T896
-------------	----	---------	---	--

2.3 dCi FWD	107	02/10 →	D	M9T678, M9T680, M9T694, M9T696, M9T698, M9T896
-------------	-----	---------	---	---

2.3 dCi FWD	107	02/10 →	D	M9T678, M9T680, M9T698, M9T896
-------------	-----	---------	---	---

2.3 dCi FWD	107	02/11 →	D	M9T680
-------------	-----	---------	---	--------

**Megane II, Station Wagon, Coupé-Cabrio**

2.0 dCi	110	09/05 → 03/09	D	M9R700, M9R722
	127	01/07 → 02/08	D	M9R724
	110	09/05 → 02/08	D	M9R700, M9R722

**82069 350982069000**

**RENAULT**
**Megane III, Station Wagon, Coupé, CC**

2.0 CVT	103	05/09 →	B	M4R711, M4RF713
2.0 dCi	120	07/12 →	D	M9R610
	110	10/10 →	D	M9R615
	118	06/10 →	D	M9R610

**Scénic II**

2.0 dCi	110	09/05 →	D	M9R700, M9R721, M9R722
---------	-----	---------	---	------------------------------

**Scénic III**

2.0 dCi	110	02/09 →	D	M9R615
	118	04/09 →	D	M9R610

**Trafic II**

2.0 dCi 115	84	08/06 →	D	M9R630, M9R692, M9R780, M9R782, M9R786
	84	08/06 →	D	M9R692, M9R780, M9R782, M9R786
	84	08/06 →	D	M9R780, M9R782, M9R786

2.0 dCi 90	66	08/06 →	D	M9R630, M9R780, M9R782
	66	08/06 →	D	M9R780, M9R782
	66	08/06 →	D	M9R782

**Vel Satis**

2.0 dCi	110	08/05 →	D	M9R760
	127	01/06 →	D	M9R760, M9R762, M9R763

**82070 350982070000**

**PULEGGIA**

Versione	TESMA
Diametro Puleggia	Ø57
Numero Denti/Gole Puleggia	23
Altezza Puleggia	23.5
Posizione Attacco	53.8
Diametro Girante	Ø63
N° Alette Girante	9
Posizione Girante	34

**ABARTH**
**500**

1.4	103	05/10 →	B	312A3.000	TESMA
	118	08/08 →	B	312A1.000, 312A3.000	TESMA
	132	08/08 →	B	312A3.000	TESMA
	139	08/08 →	B	312A1.000, 312A9.000	TESMA

**500C**

1.4	99	01/11 →	B	312A1.000	TESMA
	103	09/09 →	B	312A3.000	TESMA
	118	05/11 →	B	312A1.000, 312A3.000	TESMA
	132	09/09 →	B	312A3.000	TESMA

**Punto**

1.4	120	10/09 →	B	955A8.000	TESMA
	132	07/08 →	B	199A8.000, 955A8.000	TESMA

**ALFA ROMEO**
**Giulietta III**

1.4 BiFuel	88	12/11 →	BF	198A4.000	TESMA
1.4 TB	77	04/11 →	B	940B1.000, 940B8.000	TESMA
	85	04/10 →	B	940A6.000	TESMA
	88	04/10 →	B	198A4.000, 940B7.000	TESMA
	110	09/14 →	B	940A2.000	TESMA
	120	04/10 →	B	955A8.000	TESMA
	125	04/10 →	B	940A2.000	TESMA

**Mito**

1.4	51	05/11 →	B	955A9.000	TESMA
	57	03/11 →	B	350A1.000	TESMA
	57	03/11 →	B	955A1.000	TESMA
	58	09/08 →	B	955A1.000	TESMA
	70	09/08 →	B	199A6.000	TESMA
1.4 BiFuel	88	07/11 →	BF	198A4.000	TESMA
1.4 MultiAir	77	08/10 →	B	955A6.000	TESMA
1.4 TB	103	12/13 →	B	955B1.000	TESMA

**82070**
**350982070000**

**ALFA ROMEO**
**Mito**

1.4 T-Jet	88	09/08 →	B	198A4.000	TESMA
	110	09/08 →	B	198A1.000	TESMA
	114	09/08 →	B	199A8.000	TESMA

1.4 Turbo MultiAir	99	10/09 →	B	955A2.000, 955A7.000	TESMA
	120	10/09 →	B	955A8.000	TESMA
	125	10/09 →	B	940A2.000	TESMA

**CHRYSLER**
**Delta**

1.4	88	08/11 →	B	198A4.000	TESMA
1.4 16V	103	08/11 →	B	198A7.000	TESMA

**Ypsilon**

1.2	51	05/11 →	B	169A4.000	TESMA
-----	----	---------	---	-----------	-------

**FIAT**
**500 II, 500C**

1.2	51	10/07 →	B	169A4.000	TESMA
1.4	74	10/07 →	B	169A3.000	TESMA

**500L**

1.4	70	09/12 →	B	843A1.000	TESMA
	88	10/13 →	B	940B7.000	TESMA
1.4 LPG	88	02/14 →		940B7.000	TESMA

**500X**

1.4	100	09/14 →	B	55263624	TESMA
	103	09/14 →	B	55263624	TESMA
1.4 4x4	120	02/15 →	B	55263623	TESMA
	125	02/15 →	B	55263623	TESMA

**Bravo II, Van**

1.4	66	04/07 →	B	192B2.000	TESMA
1.4 16V	103	03/08 →	B	198A7.000	TESMA
1.4 LPG	66	11/09 →		192B2.000	TESMA
1.4 T-Jet	88	09/07 →	B	198A4.000	TESMA
	110	09/07 →	B	198A1.000	TESMA

**Doblò I, Cargo**

1.4	57	10/05 →	B	350A1.000	TESMA
-----	----	---------	---	-----------	-------

**Doblò II, Cargo**

1.4	70	02/10 →	B	843A1.000	TESMA
	88	10/11 →	B	198A4.000	TESMA
1.4 Natural Power	88	06/10 →		198A4.000	TESMA

**Fiorino IV**

1.4 Natural Power	57	10/09 →		350A1.000	TESMA
-------------------	----	---------	--	-----------	-------

**82070**
**350982070000**

**FIAT**
**Grande Punto, Van**

1.2	48	10/05 →	B	199A4.000	TESMA
	51	09/10 →	B	169A4.000	TESMA
1.2 LPG	51	07/08 →		199A4.000	TESMA
1.4	55	06/06 →	B	199A7.000	TESMA
	57	10/05 →	B	350A1.000	TESMA
1.4 16V	70	10/05 →	B	199A6.000	TESMA
	112	09/07 → 07/12	B	198A1.000	TESMA
1.4 LPG	57	12/08 →		350A1.000	TESMA
1.4 T-Jet	88	09/07 →	B	198A4.000	TESMA

**Idea**

1.2 16V	59	01/04 →	B	188A5.000	TESMA
1.4	57	10/05 →	B	350A1.000	TESMA
1.4 16V	70	01/04 →	B	843A1.000	TESMA
1.4 LPG	57	03/09 →		350A1.000	TESMA

**Linea**

1.4	57	06/07 →	B	350A1.000	TESMA
1.4 T-Jet	88	09/07 →	B	198A4.000	TESMA

**Panda II, Van**

1.2	44	09/03 →	B	188A4.000	TESMA
	51	03/10 →	B	169A4.000	TESMA
1.2 4x4	44	10/04 →	B	188A4.000	TESMA
	51	11/09 →	B	169A4.000	TESMA
1.2 LPG	44	04/09 →		188A4.000	TESMA
	51	11/10 →		169A4.000	TESMA
1.2 Natural Power	44	01/07 → 11/09		188A4.000	TESMA
1.4	74	10/06 →	B	169A3.000	TESMA
1.4 Natural Power	51	01/10 →		350A1.000	TESMA
	57	09/10 →		350A1.000	TESMA

**Panda III, Van**

1.2	51	02/12 →	B	169A4.000	TESMA
1.2 LPG	51	06/12 →		169A4.000	TESMA

**Punto Evo, Van**

1.2	48	10/09 → 02/12	B	199A4.000	TESMA
	51	10/09 → 02/12	B	169A4.000	TESMA
1.4	55	07/09 → 02/12	B	199A7.000	TESMA
	57	10/09 → 02/12	B	350A1.000	TESMA
1.4 16V	77	10/09 → 02/12	B	955A6.000	TESMA
	99	10/09 → 02/12	B	955A2.000	TESMA
1.4 LPG	57	06/09 → 02/12		350A1.000	TESMA
1.4 Natural Power	57	10/09 → 02/12		350A1.000	TESMA



**82070 350982070000**

**FIAT**
**Punto II, Cabrio, Van**

1.2 Bifuel	44	08/07 →	BF	188A4.000	TESMA
1.2 Natural Power	44	09/03 →		188A4.000	M →: 2533529, TESMA
1.4	71	11/05 →	B	199A6.000	TESMA

**Punto III, Van**

1.2	49	02/14 →	B	199B9.000	TESMA
	51	03/12 →	B	169A4.000	TESMA
1.4	55	03/12 →	B	199A7.000	TESMA
	57	03/12 →	B	350A1.000	TESMA
1.4 Bifuel	57	03/12 →	BF	350A1.000	TESMA
1.4 LPG	57	03/09 →		350A1.000	TESMA
1.4 Multi Air	77	03/12 →	B	955A6.000	TESMA
1.4 Natural Power	57	03/12 →		350A1.000	TESMA
1.4 Turbo Multi Air	99	03/12 →	B	955A2.000	TESMA

**Qubo**

1.4 Natural Power	57	10/09 →		350A1.000	TESMA
-------------------	----	---------	--	-----------	-------

**Siena I**

1.2 Flex	52	03/04 → 05/05		178E9.011	TESMA
1.4	57	01/07 → 12/09	B	178F3.011, 350A1.000	TESMA

**Siena II**

1.4	57	11/07 →	B	199A1.000	TESMA
-----	----	---------	---	-----------	-------

**Stilo, Station Wagon**

1.4 16V	66	03/05 → 11/06	B	192B2.000	TESMA
	70	01/04 → 11/06	B	843A1.000	TESMA

**Strada**

1.2	44	04/03 →	B	188A4.000	TESMA
	54	06/99 →	B	178B5.000	TESMA

**Tipo II**

1.4	70	10/15 →	B	843A1.000	TESMA
-----	----	---------	---	-----------	-------

**JEEP**
**Renegade**

1.4	103	07/14 →	B	EAM	TESMA
1.4 4x4	125	07/14 →	B	EAM	TESMA

**LANCIA**
**Delta III**

1.4	88	09/08 → 08/14	B	198A4.000	TESMA
	110	09/08 → 08/14	B	198A1.000	TESMA
1.4 16V	103	07/10 → 08/14	B	198A7.000	TESMA
1.4 Bifuel	88	07/11 → 08/14	BF	198A4.000	TESMA

**82070 350982070000**

**LANCIA**
**Musa**

1.41.4	57	09/05 → 09/12	B	350A1.000	TESMA
	66	10/07 → 09/12	B	192B2.000	TESMA
	70	10/04 → 09/12	B	843A1.000	TESMA
1.4 LPG	57	11/10 → 09/12		350A1.000	TESMA

**Ypsilon I**

1.2	44	10/03 → 12/11	B	188A4.000	TESMA
	51	08/10 → 12/11	B	169A4.000	TESMA
	59	10/03 → 12/11	B	188A5.000	TESMA
1.4	57	02/06 → 12/11	B	350A1.000	TESMA
1.4 16V	70	10/03 → 12/11	B	843A1.000	TESMA
1.4 LPG	57	11/10 → 12/11		350A1.000	TESMA

**Ypsilon II**

1.2	51	05/11 →	B	169A4.000	TESMA
1.2 Bifuel	49	05/11 →	BF	169A4.000	TESMA
	51	05/11 →	BF	169A4.000	TESMA

**OPEL**
**Combo C**

1.4	70	02/12 →	B	A14FP	TESMA
1.4 CNG	88	02/12 →		A14FC	TESMA

**82071 350982071000**

**PULEGGIA**

Diametro Puleggia Ø109.9

Altezza Puleggia 31.5

Posizione Attacco 54

Diametro Girante Ø74

N° Alette Girante 7

Posizione Girante 18.9

**LEXUS**
**IS II**

200d	110	07/10 →	D	2AD-FTV
	130	10/05 →	D	2AD-FHV

**TOYOTA**
**Auris I, Van**

2.0 D-4D	93	03/07 → 09/12	D	1AD-FTV
2.2 D	130	03/07 → 09/12	D	2AD-FHV

**Avensis II, Liftback, Station Wagon**

2.0 D-4D	93	03/06 → 11/08	D	1AD-FTV
	110	10/05 → 11/08	D	2AD-FTV
2.2 D-CAT	130	07/05 → 11/08	D	2AD-FHV

## 82071 350982071000



### TOYOTA

#### Avensis III, Liftback, Station Wagon

2.0 D-4D	93	02/09 →	D	1AD-FTV	→ 11-2011
	110	02/09 →	D	2AD-FHV, 2AD-FTV	
	130	02/09 →	D	2AD-FHV	

#### Corolla Verso

2.2 D-4D	100	10/05 → 03/09	D	2AD-FTV	
	130	10/05 → 03/09	D	2AD-FHV	

#### Corolla VIII, Hatchback, Station Wagon

2.0 D-4D	93	01/07 →	D	1AD-FTV	
	130	11/06 →	D	2AD-FHV	

#### RAV 4 III

2.2 D-4D	110	12/08 →	D	2AD-FHV, 2AD-FTV	
2.2 D-4D 4WD	100	03/06 →	D	2AD-FTV	
	110	12/08 →	D	2AD-FHV, 2AD-FTV	
2.2 D-CAT 4WD	130	03/06 →	D	2AD-FHV	

#### RAV 4 IV

2.2 D-4D 4WD	110	12/12 →	D	2AD-FHV, 2AD-FTV	
-----------------	-----	---------	---	---------------------	--

#### Verso

2.0 D-4D	91	11/12 →	D	1AD-FTV	
	93	04/09 →	D	1AD-FTV	
	110	04/09 →	D	2AD-FHV	
2.2 D-CAT	130	04/09 →	D	2AD-FHV	

## 82080 350982080000

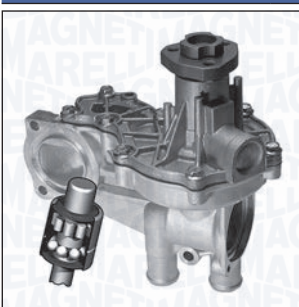

### FLANGIA

Numero Fori Flangia	3
Dimensione Fori Flangia	M8x1.25
Posizione Attacco	74
Diametro Mozzo	Ø30
Diametro Girante	Ø59
N° Alette Girante	6
Posizione Girante	29.5



### AUDI

#### 80 IV

1.6	51	08/87 → 09/91	B	PP	(+)COP
	55	09/86 → 08/91	B	RN	(+)COP
	75	08/90 → 10/91	B	ABB	(+)COP
1.6 TD	59	09/86 → 08/91	D	RA, SB	(+)COP

## 82080 350982080000



### AUDI

#### 80 IV

1.8	55	10/86 → 01/90	B	RU	(+)COP
1.8 E	82	06/86 → 08/91	B	DZ	(+)COP
1.8 E quattro	82	09/86 → 08/91	B	DZ	(+)COP
1.8 quattro	83	09/86 → 08/90	B	SD	(+)COP
1.8 S	65	08/86 → 01/90	B	SF	(+)COP
	66	09/86 → 10/91	B	JN, NE, PM	(+)COP
1.8 S quattro	65	09/86 → 07/90	B	SF	(+)COP
	66	09/86 → 09/91	B	JN, NE, PM	(+)COP
1.9 D	50	08/89 → 08/91	D	1Y	(+)COP
2.0	82	10/90 → 08/91	B	AAD	(+)COP
2.0 E	83	08/88 → 10/90	B	3A	(+)COP
2.0 E 16V	101	03/90 → 09/91	B	6A	(+)COP
2.0 E 16V quattro	101	03/90 → 08/91	B	6A	(+)COP
2.0 E quattro	83	08/88 → 09/90	B	3A	(+)COP
	82	08/88 → 07/90	B	3A	(+)COP
2.0 quattro	85	10/90 → 08/91	B	AAD	(+)COP

#### 80 V, Avant

1.6	52	09/91 → 12/94	B	ABM	(+)COP
1.6 E	74	06/93 → 12/94	B	ADA	(+)COP
1.9 TD	55	09/91 → 12/94	D	AAZ	(+)COP
1.9 TDI	66	09/91 → 12/94	D	1Z	(+)COP
2.0	66	09/91 → 12/94	B	ABT	(+)COP
2.0 E	85	09/91 → 12/94	B	ABK	(+)COP
2.0 E 16V	103	08/92 → 12/94	B	ACE	(+)COP
2.0 E 16V quattro	103	04/92 → 12/94	B	ACE	(+)COP
2.0 E quattro	85	09/91 → 12/94	B	ABK	(+)COP
2.0 quattro	79	11/93 → 01/96	B	ADW	(+)COP

#### 90 II

1.6 TD	59	04/87 → 09/91	D	RA, SB	(+)COP
2.0 quattro	101	08/89 → 07/90	B	6A	(+)COP

#### 100 III, Avant

1.8	65	02/86 → 07/90	B	SH	(+)COP
1.8 Cat.	66	03/85 → 11/90	B	4B, PH	(+)COP
1.8 quattro	65	08/86 → 07/90	B	SH	(+)COP
1.8 quattro Cat.	66	08/85 → 11/90	B	4B, PH	(+)COP

#### 100 IV, Avant

2.0	74	12/90 → 06/94	B	AAE	(+)COP
2.0 E	74	09/91 → 06/94	B	AAE	(+)COP
	85	12/90 → 06/94	B	AAD, ABK	(+)COP
2.0 E 16V	103	01/92 → 06/94	B	ACE	(+)COP

**82080 350982080000**

**AUDI**
**100 IV, Avant**

2.0 E 16V quattro	103	07/92 → 06/94	B	ACE	(+)COP
2.0 E quattro	85	12/90 → 07/92	B	AAD	(+)COP

**A6 I, Avant**

1.9 TDI	66	06/94 → 10/97	D	1Z, AHU	(+)COP
	66	06/94 → 10/97	D	1Z, AHU	(+)COP, M: 1Z
2.0	74	06/94 → 10/97	B	AAE	(+)COP
	79	08/95 → 07/96	B	ADW	(+)COP
	85	06/94 → 10/97	B	ABK	(+)COP
2.0 16V	103	06/94 → 10/97	B	ACE	(+)COP
2.0 16V quattro	103	06/94 → 10/97	B	ACE	(+)COP

**Cabriolet**

1.9 TDI	66	06/95 → 08/00	D	1Z, AHU	(+)COP
2.0 16V	103	06/95 → 07/96	B	ACE	(+)COP
2.0 E	85	01/93 → 07/98	B	ABK	(+)COP

**Coupé II**

2.0	82	03/90 → 07/90	B	3A	(+)COP
	83	05/89 → 03/90	B	3A	(+)COP
	85	05/89 → 12/96	B	AAD, ABK	(+)COP
2.0 16 V	101	01/92 → 07/92	B	6A	(+)COP
	103	08/92 → 12/96	B	ACE	(+)COP

**FORD**

1.9 TDI	66	03/95 → 05/06	D	1Z, AHU, ANU	(+)COP
	66	03/95 → 05/06	D	1Z, AHU, ANU	(+)COP, → 04-2000
	81	08/97 → 04/00	D	AFN, AVG	(+)COP
	81	08/97 → 04/00	D	AFN, AVG	(+)COP, → 04-2000

**SEAT**
**Alhambra I**

1.9 TDI	66	04/96 → 03/10	D	1Z, AHU, ANU	(+)COP
	66	04/96 → 03/10	D	1Z, AHU, ANU	(+)COP, → 07-2000
	81	08/96 → 06/00	D	AFN, AVG	(+)COP
2.0 i	85	04/96 → 03/10	B	ADY, ATM	(+)COP
	85	04/96 → 03/10	B	ADY, ATM	(+)COP, → 07-2000, M: ADY

**82080 350982080000**

**SEAT**
**Cordoba I, Vario**

1.6 i	55	05/94 → 06/99	B	1F	(+)COP
	74	09/96 → 06/99	B	AFT	(+)COP
	74	07/96 → 10/99	B	AFT, AKL	(+)COP
	55	09/96 → 06/99	B	AEE, ALM	(+)COP
1.8 i	66	02/93 → 06/99	B	ABS, ACC, ADZ	(+)COP
	66	02/93 → 06/99	B	ABS, ACC, ADZ	(+)COP, 10-1993 →
1.8 i 16V	95	10/93 → 08/96	B	ADL	(+)COP
	95	10/93 → 08/96	B	ADL	(+)COP, 10-1993 →
1.9 D	47	01/96 → 08/96	D	1Y	(+)COP
	47	01/96 → 08/96	D	1Y	(+)COP, 06-1996 →
	50	02/93 → 08/96	D	1Y	(+)COP
	50	02/93 → 08/96	D	1Y	(+)COP, 10-1993 →
1.9 SDI	47	08/96 → 06/99	D	AEY	(+)COP
	47	08/96 → 06/99	D	AEY	(+)COP, 05-1997 →
1.9 TD	55	02/93 → 08/96	D	AAZ	(+)COP
	55	02/93 → 08/96	D	AAZ	(+)COP, 10-1993 →
1.9 TDI	66	08/96 → 06/99	D	1Z, AHU	(+)COP
	66	08/96 → 06/99	D	1Z, AHU	(+)COP, 06-1996 →
	81	03/97 → 06/99	D	AFN	(+)COP
2.0 i	81	03/97 → 06/99	D	AFN	(+)COP, 05-1997 →
	85	02/93 → 06/99	B	2E, AGG	(+)COP
2.0 i	85	02/93 → 06/99	B	2E, AGG	(+)COP, 10-1993 →
	110	08/96 → 06/99	B	ABF	(+)COP
2.0 i 16V	110	08/96 → 06/99	B	ABF	(+)COP, 02-1997 →

**Ibiza II**

1.6 i	55	09/94 → 06/99	B	1F	(+)COP
	74	04/96 → 08/99	B	AFT	(+)COP
	55	03/93 → 08/99	B	ABU, AEE, ALM	(+)COP
	55	03/93 → 08/99	B	ABU, AEE, ALM	(+)COP, 01-1995 →, M: AEE

**82080**
**350982080000**

**SEAT**
**Ibiza II**

1.8 i	66	03/93 → 08/99	B	ABS, ACC, ADZ	(+)COP
	66	03/93 → 08/99	B	ABS, ACC, ADZ	(+)COP, 01-1993→
1.8 i 16V	95	11/93 → 08/96	B	ADL	(+)COP
1.9 D	47	04/93 → 08/96	D	1Y, AEY	(+)COP
	50	10/94 → 08/96	D	1Y	(+)COP
1.9 SDI	47	08/96 → 08/99	D	AEY	(+)COP
1.9 TD	55	03/93 → 08/96	D	AAZ	(+)COP
2.0 i	85	03/93 → 08/99	B	2E, AGG	(+)COP
2.0 i 16V	110	08/96 → 08/99	B	ABF	(+)COP

**Inca**

1.6 i	55	11/95 → 05/98	B	1F	(+)COP
	55	11/95 → 05/98	B	1F	(+)COP, 11-1995→
1.7 D	42	09/96 → 06/03	D	AHB	(+)COP
1.9 D	47	11/95 → 06/03	D	1Y	(+)COP
	47	11/95 → 06/03	D	1Y	(+)COP, 11-1995→
1.9 SDI	47	11/95 → 06/03	D	1Y, AEY, AYQ	(+)COP
	47	11/95 → 06/03	D	1Y, AEY, AYQ	(+)COP, 11-1995→

**Toledo I**

	52	05/91 → 12/93	B	1F	(+)COP
	54	05/91 → 03/99	B	1F, ABN, EZ	(+)COP
	54	05/91 → 03/99	B	1F, ABN, EZ	(+)COP, 05-1991→
	55	01/93 → 03/99	B	1F	(+)COP
	55	01/93 → 03/99	B	1F	(+)COP, 05-1991→
	74	11/96 → 03/99	B	AFT	(+)COP
1.8 16V	92	05/91 → 03/99	B	PL	(+)COP
	92	05/91 → 03/99	B	PL	(+)COP, 05-1991→
	98	05/91 → 03/99	B	KR	(+)COP
	98	05/91 → 03/99	B	KR	(+)COP, 05-1991→
1.8 GT	102	05/91 → 11/92	B	KR	(+)COP
1.8 i	65	05/91 → 12/96	B	RP	(+)COP
	66	11/93 → 12/96	B	ABS, ACC, ADZ	(+)COP

**82080**
**350982080000**

**SEAT**
**Toledo I**

1.9 D	47	12/95 → 03/99	D	1Y	(+)COP
	47	12/95 → 03/99	D	1Y	(+)COP, 05-1991→
	50	05/91 → 03/99	D	1Y	(+)COP
1.9 TD	50	05/91 → 03/99	D	1Y	(+)COP, 05-1991→
	55	05/91 → 03/99	D	AAZ	(+)COP
1.9 TDI	55	05/91 → 03/99	D	AAZ	(+)COP, 05-1991→
	66	08/95 → 03/99	D	1Z, AHU	(+)COP
1.9 TDI	66	08/95 → 03/99	D	1Z, AHU	(+)COP, 05-1991→
	81	11/96 → 03/99	D	AFN	(+)COP
1.9 TDI	81	11/96 → 03/99	D	AFN	(+)COP, 05-1991→
	81	11/96 → 03/99	D	AFN	(+)COP
2.0 i	85	05/91 → 03/99	B	2E, AGG	(+)COP
2.0 i 16V	110	11/93 → 03/99	B	ABF	(+)COP
	110	11/93 → 03/99	B	ABF	(+)COP, 01-1997→

**VOLKSWAGEN**
**Caddy I**

1.6	55	01/83 → 07/92	B	EW	(+)COP
1.6 D	40	08/82 → 07/92	D	JK, ME	(+)COP
1.8	70	08/85 → 07/92	B	JH	(+)COP

1.6	55	11/95 → 05/97	B	1F	(+)COP
1.7 SDI	42	07/96 → 09/00	D	AHB	(+)COP
1.9 D	47	11/95 → 01/04	D	1Y	(+)COP
1.9 SDI	47	11/95 → 01/04	D	AEY, AYQ	(+)COP
	47	11/95 → 01/04	D	AEY, AYQ	(+)COP, M: AEY
1.9 TDI	66	09/96 → 01/04	D	1Z, AHU, ALH	(+)COP
	66	10/96 → 01/04	D	AHU, ALE, ALH	(+)COP
75 1.6	55	11/95 → 05/97	B	1F	(+)COP

**Corrado**

1.8 16V	100	04/89 → 07/92	B	KR	(+)COP
1.8 G60	118	09/88 → 09/93	B	PG	(+)COP
2.0 i	85	04/93 → 12/95	B	2E, ADY	(+)COP
2.0 i 16V	100	08/91 → 12/95	B	9A	(+)COP

**82080 350982080000**

**VOLKSWAGEN**
**Golf I, Cabrio**

1.6	53	04/86 → 02/90	B	RE	(+)COP
	55	08/83 → 04/92	B	EW, HN	(+)COP
1.8	66	08/83 → 09/92	B	EX	(+)COP
	70	08/83 → 04/93	B	JH	(+)COP
	72	08/89 → 03/93	B	2H	(+)COP

**Golf II**

1.6	51	10/86 → 12/92	B	PN	(+)COP
	53	02/86 → 10/91	B	RF	(+)COP
	55	08/83 → 07/92	B	ABN, EZ, HM	(+)COP
1.6 D	37	08/83 → 10/91	D		(+)COP
	40	08/83 → 10/91	D	JP, ME	(+)COP
1.6 TD	51	08/83 → 10/91	D	JR, MF	(+)COP
	59	04/89 → 10/91	D	RA, SB	(+)COP
	44	08/89 → 10/91	D	1V	(+)COP
1.8	62	08/86 → 01/90	B	RH	(+)COP
	66	08/84 → 10/91	B	GU, GX, HV	(+)COP
1.8 GTI	82	08/83 → 10/91	B	DX, EV, GZ, PB	(+)COP
1.8 GTI 16V	95	02/86 → 10/91	B	PL	(+)COP
	102	02/86 → 06/90	B	KR	(+)COP
1.8 GTI Cat.	79	01/87 → 10/91	B	PF	(+)COP
1.8 GTI G60	118	04/90 → 07/91	B	PG	(+)COP
1.8 GTI G60 Syncro	118	08/88 → 12/91	B	1H, PG	(+)COP
1.8 i Cat.	66	08/87 → 10/91	B	GX, RP	(+)COP
1.8 i Syncro Cat.	66	08/87 → 10/91	B	RP	(+)COP
1.8 Syncro	66	02/86 → 07/91	B	GU, GX	(+)COP
	72	08/88 → 07/91	B	1P	(+)COP
2.0	57	08/85 → 07/92	B		(+)COP

**Golf III, Variant, Cabrio**

1.6	74	10/94 → 05/98	B	AEK, AFT, AKS	(+)COP, 05-1996 →
	74	07/95 → 08/97	B	AEK, AFT, AKS	(+)COP
	74	07/95 → 08/97	B	AEK, AFT, AKS	(+)COP, M: AEK -AFT

**82080 350982080000**

**VOLKSWAGEN**
**Golf III, Variant, Cabrio**

1.8	55	11/91 → 08/97	B	AAM	(+)COP
	55	07/93 → 04/99	B	AAM, ANN	(+)COP
	66	11/91 → 08/97	B	ABS, ACC, ADZ	(+)COP
	66	07/93 → 05/98	B	ABS, ADZ	(+)COP
	66	07/93 → 04/99	B	ABS, ADZ, ANP	(+)COP
1.8 Syncro	66	10/94 → 04/99	B	ADZ	(+)COP
	66	01/93 → 08/97	B	ABS, ADZ	(+)COP
1.9 D	48	11/91 → 08/97	D	1Y	(+)COP
	48	11/91 → 08/97	D	1Y	(+)COP, → 07-1995
1.9 SDI	47	07/95 → 08/97	D	AEY	(+)COP
1.9 TD	55	07/93 → 04/99	D	AAZ	(+)COP
	55	07/93 → 04/99	D	AAZ	(+)COP, → 07-1995
1.9 TD, GTD	55	11/91 → 08/97	D	AAZ	(+)COP
	55	11/91 → 08/97	D	AAZ	(+)COP, → 07-1995
1.9 TDI	66	09/93 → 08/97	D	1Z, AHU, ALE	(+)COP
	66	09/93 → 08/97	D	1Z, AHU, ALE	(+)COP, → 07-1995
	66	08/95 → 05/98	D	1Z, AHU, ALE	(+)COP, M: 1Z
	81	04/96 → 08/97	D	AFN	(+)COP
1.9 TDI Syncro	66	07/95 → 04/99	D	1Z, AHU, ALE	(+)COP
	66	07/95 → 04/99	D	1Z, AHU, ALE	(+)COP, → 07-1995
2.0	79	08/95 → 04/96	B	AEP	(+)COP
	85	11/91 → 08/97	B	2E, ABA, ADY, AGG, AKR	(+)COP
	85	07/93 → 05/98	B	2E, ADY, AGG, AKR	(+)COP
	85	07/93 → 05/98	B	2E, ADY, AGG, AKR	(+)COP, 08-1991 →
	2.0 GTI 16V	110	08/92 → 08/97	B	ABF
110		08/92 → 08/97	B	ABF	(+)COP, 08-1991 →

**82080**
**350982080000**

**VOLKSWAGEN**
**Golf III, Variant, Cabrio**

2.0 Syncro	85	08/95 → 04/99	B	AGG	(+)COP
	85	08/95 → 04/99	B	AGG	(+)COP, 08-1991 →
	85	08/95 → 08/97	B	AGG	(+)COP
	85	08/95 → 08/97	B	AGG	(+)COP, 08-1991 →

**Golf IV, Variant, Cabrio**

1.6	74	06/98 → 06/02	B	AFT, AKS	(+)COP
	74	06/98 → 06/02	B	AFT, AKS	(+)COP, 05-1996 →
1.8	55	06/98 → 06/02	B	AAM, ANN	(+)COP
	55	06/98 → 06/02	B	AAM, ANN	(+)COP, 11-1991 →
	66	06/98 → 06/02	B	ADZ, ANP	(+)COP
	66	06/98 → 06/02	B	ADZ, ANP	(+)COP, 11-1991 →
1.9 TDI	66	06/98 → 06/02	D	AHU, ALE	(+)COP
	81	06/98 → 06/02	D	AFN, AVG	(+)COP
2.0	85	06/98 → 06/02	B	AGG, AKR, ATU, AWF, AWG	(+)COP
	85	06/98 → 06/02	B	AGG, AKR, ATU, AWF, AWG	(+)COP, 08-1991 →

**Jetta II**

1.6	51	10/86 → 10/91	B	PN	(+)COP
	53	03/86 → 10/91	B	RF	(+)COP
	55	01/84 → 07/92	B	ABN, EZ, HM	(+)COP
1.6 D	40	01/84 → 10/91	D	JP, ME	(+)COP
1.6 TD	51	01/84 → 10/91	D	JR, MF	(+)COP
	59	04/89 → 10/91	D	RA, SB	(+)COP
	44	01/90 → 10/91	D	1V	(+)COP
1.8	62	08/86 → 01/90	B	RH	(+)COP
	66	08/84 → 10/91	B	GU, GX, HV	(+)COP
	82	01/84 → 10/91	B	EV, GZ, PB	(+)COP
1.8 16V	95	08/86 → 10/91	B	PL	(+)COP
1.8 Cat.	66	08/87 → 10/91	B	GX, RP	(+)COP
	79	01/87 → 10/91	B	PF	(+)COP
1.8 Syncro	72	08/88 → 07/91	B	1P	(+)COP

**Passat III, Variant**

1.6	53	02/88 → 09/91	B	1F, EZ	(+)COP
	74	10/94 → 08/96	B	AEK, AFT	(+)COP
1.6 TD	59	08/88 → 09/93	D	RA, SB	(+)COP

**82080**
**350982080000**

**VOLKSWAGEN**
**Passat III, Variant**

1.8	55	08/90 → 08/96	B	AAM	(+)COP
	66	02/88 → 08/96	B	ABS, ADZ, RP	(+)COP
	79	04/88 → 07/93	B	PF	(+)COP
	82	04/88 → 07/92	B	PB	(+)COP
	102	08/91 → 09/93	B	KR	(+)COP
1.8 G60 Syncro	118	08/88 → 08/96	B	PG	(+)COP
1.8 GL	102	08/91 → 09/93	B	KR	(+)COP
1.9 D	50	05/89 → 10/93	D	1Y	(+)COP
1.9 TD	55	03/91 → 08/96	D	AAZ	(+)COP
1.9 TDI	66	10/93 → 08/96	D	1Z, AHU	(+)COP
	81	03/96 → 08/96	D	AFN	(+)COP
2.0	79	03/95 → 08/96	B	AEP	(+)COP
	85	02/90 → 10/96	B	2E, ABA, ADY, AGG	(+)COP
	85	02/90 → 05/97	B	2E, ADY, AGG	(+)COP
2.0 16V	125	04/88 → 07/91	B		(+)COP
	100	08/88 → 09/93	B	9A	(+)COP
2.0 Syncro	110	01/94 → 08/96	B	ABF	(+)COP
	81	09/89 → 07/92	B		(+)COP
2.0 Syncro	85	10/90 → 08/96	B	2E, ADY, AGG	(+)COP

**Polo III (6N1), Classic, Variant, Van**

1.6	74	05/97 → 09/01	B	AEH, AFT, AKL, APF, AUR	(+)COP
	74	05/97 → 09/01	B	AEH, AFT, AKL, APF, AUR	(+)COP, M: AFT AUR
1.7 SDI	42	08/97 → 09/01	D	AKW	(+)COP
1.8	66	05/97 → 09/01	B	ADZ	(+)COP
	47	06/97 → 09/01	D	AEY	(+)COP
1.9 SDI	48	06/96 → 09/01	D	AEY	(+)COP
	66	05/97 → 09/01	D	AGR, AHU, ALE, ALH	(+)COP
	66	05/97 → 09/01	D	AGR, AHU, ALE, ALH	(+)COP, M: ALE
100 1.6	74	12/95 → 09/01	B	AEH, AFT, AKL, APF, AUR	(+)COP
	74	12/95 → 09/01	B	AEH, AFT, AKL, APF, AUR	(+)COP, M: AFT AUR

**82080 350982080000**

**VOLKSWAGEN**
**Polo III (6N1), Classic, Variant, Van**

110 1.9 TDI	81	06/98 → 01/02	D	AFN, ASV	(+)COP
57 1.7 SDI	42	07/97 → 09/01	D	AKW	(+)COP
64 1.9 D	47	01/96 → 10/96	D	1Y	(+)COP
64 1.9 SDI	47	12/95 → 08/99	D	1Y, AEY	(+)COP
75 1.6	55	11/95 → 09/97	B	1F	(+)COP
90 1.8	66	01/97 → 09/01	B	ABS, ADD, ADZ	(+)COP
90 1.9 TDI	66	09/96 → 09/01	D	AGR, AHU, ALE, ALH	(+)COP
	66	09/96 → 09/01	D	AGR, AHU, ALE, ALH	(+)COP, M: ALE

**Scirocco II**

1.6	53	04/86 → 07/90	B	RE	(+)COP
1.8	66	08/83 → 07/92	B	EX	(+)COP
	70	11/85 → 07/92	B	JH	(+)COP
1.8 16V	95	03/86 → 07/92	B	PL	(+)COP

**Sharan I**

1.9 TDI	66	09/95 → 03/10	D	1Z, AHU, ANU	(+)COP
	66	09/95 → 03/10	D	1Z, AHU, ANU	(+)COP, 09-1995 →, → 03-2000, M: 1Z, M: AHU
	81	09/96 → 04/00	D	AFN, AVG	(+)COP
2.0	85	09/95 → 03/10	B	ADY, ATM	(+)COP
	85	09/95 → 03/10	B	ADY, ATM	(+)COP, 09-1995 →, → 02-2000, M: ADY

**Transporter III**

1.6 TD	51	08/84 → 07/92	D	JX	(+)COP
	51	08/84 → 07/92	D	JX	(+)COP, M →: 012.053
1.6 TD Syncro	51	03/86 → 07/92	D	JX	(+)COP
	51	03/86 → 07/92	D	JX	(+)COP, M →: 012.053
1.7 D	42	10/86 → 07/92	D	KY	(+)COP

**Transporter IV**

1.8	49	12/90 → 07/92	B	PD	(+)COP
1.9 D	44	09/90 → 12/95	D	1X	(+)COP
	45	07/90 → 12/95	D	1X	(+)COP
1.9 TD	50	10/92 → 04/03	D	ABL	(+)COP
2.0	62	07/90 → 04/03	B	AAC	(+)COP, 09-1990 →
	62	09/90 → 04/03	B	AAC	(+)COP

**82080 350982080000**

**VOLKSWAGEN**
**Vento**

1.6	74	10/94 → 09/98	B	AEK, AFT	(+)COP
1.8	55	11/91 → 09/98	B	AAM	(+)COP
	66	11/91 → 09/98	B	ABS, ADZ	(+)COP
1.9 D	48	11/91 → 09/98	D	1Y	(+)COP
1.9 SDI	47	04/97 → 09/98	D	AEY	(+)COP
1.9 TD	55	11/91 → 09/98	D	AAZ	(+)COP
1.9 TDI	66	09/93 → 09/98	D	1Z, AHU, ALE	(+)COP
	81	04/96 → 09/98	D	AFN	(+)COP
2.0	85	11/91 → 09/98	B	2E, ADY, AGG, AKR	(+)COP
2.0 GL	62	11/91 → 07/98	B	AAC	(+)COP
	79	05/96 → 12/97	B	AEP	(+)COP

**82081 350982081000**

	<b>PULEGGIA</b> Diametro Puleggia Ø66 Altezza Puleggia 30.5 Posizione Attacco 60.8 Diametro Girante Ø79 N° Alette Girante 5 Posizione Girante 29.4
--	--

**AUDI**
**A6 II, Avant**

3.7	191	03/99 → 01/05	B	AQG	
3.7 quattro	191	03/99 → 01/05	B	AQG	
4.2 quattro	220	11/98 → 01/05	B	ARS, ASG, AWN	04-1999 →
	220	11/98 → 01/05	B	ARS, ASG, AWN	
RS6 plus quattro	353	04/04 → 01/05	B	BRV	
RS6 quattro	331	07/02 → 01/05	B	BCY	
S6 quattro	250	09/99 → 01/05	B	ANK, AQJ	04-1999 →
	250	09/99 → 01/05	B	ANK, AQJ	

**A8 I**

3.7	191	11/98 → 09/02	B	AKC, AQG	
3.7 quattro	191	11/98 → 09/02	B	AKC, AQG	
4.2 quattro	175	02/99 → 04/00	B	ARU	
	228	11/98 → 09/02	B	AQF, AUW, AUX	

## 82081 350982081000



### AUDI

#### A8 I

S 8 quattro 265 06/99 → 09/02 B AQH, AVP

#### A8 II

3.7 quattro 206 10/02 → 05/06 B BFL

4.2 quattro 246 10/02 → 07/10 B BFM

### VOLKSWAGEN

#### Phaeton

4.2 V8 4motion 246 05/03 → B BGH, BGJ

#### Touareg I

4.2 V8 228 12/02 → 11/06 B AXQ, BHX

## 82082 350982082000



### MERCEDES-BENZ

#### Classe C II (W203), Station Wagon (S203), Coupé (CL203)

C 200 CDI 75 03/01 → 08/07 D OM611.962, OM646.962

#### Classe C III (W204), Station Wagon (S204), Coupé (C204)

100 08/07 → 12/11 D OM646.811

100 01/07 → 12/10 D OM646.811, OM646.812

120 01/07 → 11/08 D OM646.811

125 01/07 → 11/08 D OM646.811

#### Classe CLC

CLC 200 90 05/08 → 06/11 D OM646.962

CDI 110 05/08 → 06/11 D OM646.963

#### Classe E III (W211), Station Wagon (S211)

75 07/02 → 12/08 D OM646.951

90 07/02 → 12/08 D OM646.951

100 04/06 → 12/08 D OM646.820

100 04/06 → 07/09 D OM646.821

## 82082 350982082000



### MERCEDES-BENZ

#### Classe E III (W211), Station Wagon (S211)

E 220 CDI 120 03/03 → 12/08 D OM646.821

100 03/02 → 12/08 D OM646.961

110 03/02 → 12/08 D OM646.961

125 04/06 → 12/08 D OM646.821

E 220 T 120 03/03 → 07/09 D OM646.821

CDI 110 03/03 → 07/09 D OM646.961

125 04/06 → 07/09 D OM646.821

E 270 CDI 120 03/02 → 12/08 D OM647.961

E 270 T CDI 120 03/03 → 07/09 D OM647.961

#### CLK II (C209), Cabrio (A209)

220 CDI 100 01/05 → 05/09 D OM646.966

110 01/05 → 05/09 D OM646.966

## 82083 350982083000

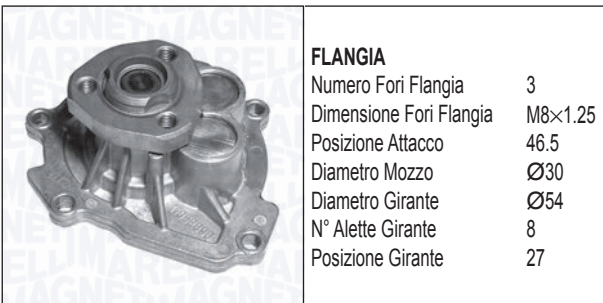

### ALFA ROMEO

#### 159, Sportwagon

1.8 MPI 103 03/07 → 11/11 B 939A4.000

### CHEVROLET

#### Aveo II

1.6 85 03/11 → B F16D4

#### Cruze II, Hatchback, Station Wagon

80 05/09 → B F16D3, LXT, LXV

80 01/12 → B LXT

83 05/09 → B F16D4

1.6 86 12/12 → B F16D4

86 12/12 → B LDE

91 06/11 → B F16D4

91 05/09 → B F16D4, LDE

91 08/12 → B LDE

1.8 104 08/12 → B 2H0

104 05/09 → B 2H0, F18D4

104 06/11 → B F18D4



**82083 350982083000**

**CHEVROLET**
**Cruze II, Hatchback, Station Wagon**

1.8 LPG	104	06/11 →		2H0, F18D4
	104	06/11 →		F18D4

**Trax**

1.6	85	12/12 →	B	F16D4, LDE
-----	----	---------	---	------------

**FIAT**
**Croma II**

1.8 16V	103	12/05 →	B	939A4.000
---------	-----	---------	---	-----------

**Stilo, Station Wagon**

1.6 16V	77	03/05 → 12/07	B	192B3.000
---------	----	---------------	---	-----------

**OPEL**
**Astra G, Station Wagon, Coupé, Cabrio, Van**

1.6	76	12/02 → 12/09	B	Z16XEP
-----	----	---------------	---	--------

1.6 16V	76	03/00 → 05/05	B	Z16XEP
---------	----	---------------	---	--------

**Astra H, Station Wagon, GTC, Twin Top, Van**

1.6	76	02/04 → 11/04	B	Z16XEP
-----	----	---------------	---	--------

	77	03/04 →	B	Z16XE1, Z16XEP
--	----	---------	---	----------------

	85	12/06 →	B	A16XER, Z16XER
--	----	---------	---	----------------

	85	12/06 →	B	Z16XER
--	----	---------	---	--------

1.6 LPG	85	08/09 →		Z16XER
---------	----	---------	--	--------

1.6 Turbo	132	02/07 →	B	Z16LET
-----------	-----	---------	---	--------

1.8	92	03/04 →	B	Z18XE
-----	----	---------	---	-------

	103	01/06 →	B	A18XER, Z18XER
--	-----	---------	---	----------------

	103	01/06 →	B	Z18XER
--	-----	---------	---	--------

**Astra J, Station Wagon, GTC**

1.6	85	12/09 →	B	A16XER, B16XER
-----	----	---------	---	----------------

	132	10/11 →	B	A16LET
--	-----	---------	---	--------

1.6 Turbo	132	12/09 →	B	A16LET
-----------	-----	---------	---	--------

1.8	103	10/11 →	B	A18XER
-----	-----	---------	---	--------

1.6 Turbo	110	02/07 →	B	A16LEL, Z16LEL
-----------	-----	---------	---	----------------

	141	02/07 →	B	A16LER, B16LER, Z16LER
--	-----	---------	---	------------------------

	155	06/11 →	B	A16LES, B16LES
--	-----	---------	---	----------------

**Corsa E, Van**

1.6 Turbo	152	03/15 →	B	B16LES
-----------	-----	---------	---	--------

**82083 350982083000**

**OPEL**
**Insignia, Station Wagon**

1.6	85	07/08 →	B	A16XER
-----	----	---------	---	--------

1.6 Turbo	132	07/08 →	B	A16LET
-----------	-----	---------	---	--------

1.8	103	07/08 →	B	A18XER
-----	-----	---------	---	--------

**Meriva A**

1.6	77	01/06 → 05/10	B	Z16XEP
-----	----	---------------	---	--------

1.6 Turbo	132	09/05 → 05/10	B	Z16LET
-----------	-----	---------------	---	--------

**Mokka**

1.6	85	06/12 →	B	A16XER, B16XER
-----	----	---------	---	----------------

1.8	103	01/13 →	B	A18XER
-----	-----	---------	---	--------

1.8 4x4	103	01/13 →	B	A18XER
---------	-----	---------	---	--------

**Signum**

1.8	103	09/05 →	B	Z18XER
-----	-----	---------	---	--------

**Vectra C, Station Wagon**

1.6	77	01/06 →	B	Z16XEP
-----	----	---------	---	--------

1.8	103	01/06 →	B	Z18XER
-----	-----	---------	---	--------

**Zafira B, Van**

1.6	77	07/05 →	B	Z16XE1, Z16XEP
-----	----	---------	---	----------------

	85	01/08 →	B	A16XER, Z16XER
--	----	---------	---	----------------

1.6 CNG Turbo	110	02/09 →		A16XNT, Z16XNT
---------------	-----	---------	--	----------------

1.8	88	06/13 →	B	A18XEL
-----	----	---------	---	--------

	103	07/05 →	B	A18XER, Z18XER
--	-----	---------	---	----------------

1.6 CNG	110	10/11 →		A16XNT, B16XNT
---------	-----	---------	--	----------------

	85	10/11 →	B	A18XEL
--	----	---------	---	--------

1.8	88	10/11 →	B	A18XEL
-----	----	---------	---	--------

	103	10/11 →	B	A18XER
--	-----	---------	---	--------

1.8 LPG	101	10/11 →		A18XER
---------	-----	---------	--	--------

1.6 Turbo	132	05/10 → 01/12	B	A16LET
-----------	-----	---------------	---	--------

1.6 CNG	110	10/11 →		A16XNT, B16XNT
---------	-----	---------	--	----------------

	85	10/11 →	B	A18XEL
--	----	---------	---	--------

1.8	88	10/11 →	B	A18XEL
-----	----	---------	---	--------

	103	10/11 →	B	A18XER
--	-----	---------	---	--------

1.8 LPG	101	10/11 →		A18XER
---------	-----	---------	--	--------

**SAAB**
**9-5 II, Station Wagon**

1.6 Turbo	132	05/10 → 01/12	B	A16LET
-----------	-----	---------------	---	--------

**VAUXHALL**
**ASTRA**

1.6	85	12/09 →	B	A16XER, B16XER
-----	----	---------	---	----------------

## 82083 350982083000



### VAUXHALL

#### ASTRA

1.6 16V	74	09/98 → 05/05	B	C16SEL, X16XEL, Z16XE, Z16XEP	05-2004 →, M: Z16XEP
	74	03/01 → 10/05	B	Z16XE	05-2004 →, M: Z16XEP
1.6 Turbo	132	12/09 →	B	A16LET	

## 82084 350982084000



**PULEGGIA**

Diametro Puleggia Ø105

Altezza Puleggia 31

Posizione Attacco 70.7

Diametro Girante Ø78

N° Alette Girante 8

Posizione Girante 13.5



### MERCEDES-BENZ

#### Classe E II (W210), Station Wagon (S210)

E 320 CDI	145	07/99 → 03/02	D	OM613.961
E 320 T CDI	145	07/99 → 03/03	D	OM613.961

## 82085 350982085000



**PULEGGIA**

Diametro Puleggia Ø59

Numero Denti/Gole Puleggia 20

Altezza Puleggia 30

Posizione Attacco 48

Diametro Girante Ø77

N° Alette Girante 6

Posizione Girante 21



### HYUNDAI

#### Accent II

1.5 CRDi	60	04/02 → 11/05	D	D3EA
----------	----	---------------	---	------

#### Elantra I

2.0 CRDi	83	04/01 → 07/06	D	D4EA
----------	----	---------------	---	------

#### Getz

1.5 CRDi	60	03/03 → 09/05	D	D3EA
----------	----	---------------	---	------

#### Matrix

1.5 CRDi	60	10/01 → 08/10	D	D3EA
----------	----	---------------	---	------

## 82085 350982085000



### HYUNDAI

#### Santa Fé I

2.0 CRDi	83	08/01 → 03/06	D	D4EA
2.0 CRDi 4x4	83	04/01 → 03/06	D	D4EA
	92	08/03 → 03/06	D	D4EA
2.0 CRDi Trazione integrale	107	11/03 → 02/06	D	D4EA

#### Trajét

2.0 CRDi	83	04/01 → 07/08	D	D4EA
	92	08/05 → 07/08	D	D4EA

#### Tucson I

2.0 CRDi	83	08/04 → 03/10	D	D4EA	→ 12-2005
2.0 CRDi Trazione integrale	83	08/04 → 03/10	D	D4EA	→ 12-2005

### KIA

#### Carens II

2.0 CRDi	83	07/02 →	D	D4EA
----------	----	---------	---	------

#### Cee'd I, Station Wagon

2.0 CRDi 140	103	09/07 → 12/12	D	D4EA-F
-----------------	-----	---------------	---	--------

#### Cerato I

2.0 CRDi	83	04/04 →	D	D4EA	→ 05-2005
----------	----	---------	---	------	-----------

#### Sportage II

2.0 CRDi	83	02/05 →	D	D4EA
	103	01/06 →	D	D4EA-V
2.0 CRDi 4WD	83	09/04 →	D	D4EA
	103	01/06 →	D	D4EA-F, D4EA-V

**82086**
**350982086000**

	<b>FLANGIA</b>	
	Numero Fori Flangia	3
	Dimensione Fori Flangia	M8x1.25
	Posizione Attacco	65.3
	Diametro Mozzo	Ø22
	Diametro Centraggio	Ø25.95
	Diametro Girante	Ø70
	N° Alette Girante	9
	Posizione Girante	28.4

**KW**

**FIAT**
**Punto I, Cabrio, Van**

1.7 TD	46	09/96 → 09/99	D	176B7.000	
	51	01/94 → 09/99	D	176A3.000	08-1996 →
	52	01/94 → 09/99	D	176A5.000	08-1996 →

**Palio I, Weekend**

1.7 TD	51	04/96 → 03/01	D	176A3.000	10-1999 →, M →: 2.427.907
--------	----	---------------	---	-----------	------------------------------

**Siena I**

1.7 TD	51	02/06 → 12/09	D	176A3.000	
--------	----	---------------	---	-----------	--

**Strada**

1.7 TD	51	06/99 →	D	176A3.000	M →: 2.427.907
--------	----	---------	---	-----------	----------------

**82087**
**350982087000**

	<b>FLANGIA</b>	
	Numero Fori Flangia	4
	Dimensione Fori Flangia	M6x1
	Posizione Attacco	61.45
	Diametro Mozzo	Ø30
	Diametro Girante	Ø58
	N° Alette Girante	6
	Posizione Girante	18.5

**KW**

**MERCEDES-BENZ**
**Classe A I (W168)**

A 140	60	07/97 → 08/04	B	M166.940	
	60	01/01 → 08/04	B	M166.960	
A 160	75	07/97 → 08/04	B	M166.960	
A 160 CDI	44	07/98 → 02/01	D	OM668.941	
	55	02/01 → 08/04	D	OM668.940	
A 170 CDI	66	07/98 → 02/01	D	OM668.940	
	70	02/01 → 08/04	D	OM668.942	
A 190	92	03/99 → 08/04	B	M166.990	
A 210	103	03/02 → 08/04	B	M166.995	

**82087**
**350982087000**

	<b>KW</b>				
--	-----------	--	--	--	--

**MERCEDES-BENZ**
**Vaneo**

1.6	60	02/02 → 07/05	B	M166.961	
	75	02/02 → 07/05	B	M166.961	
1.7 CDI	55	02/02 → 07/05	D	OM668.914	
	67	02/02 → 07/05	D	OM668.914	
1.9	92	02/02 → 07/05	B	M166.991	

**82088**
**350982088000**

	<b>PULEGGIA</b>	
	Diametro Puleggia	Ø90
	Altezza Puleggia	34.5
	Posizione Attacco	74.4
	Diametro Girante	Ø73.5
	N° Alette Girante	6
	Posizione Girante	12.5

**KW**

**MERCEDES-BENZ**
**Classe C I (W202), Station Wagon (S202)**

C 200 T CDI	75	03/98 → 03/01	D	OM611.960	
C 220 CDI	92	09/97 → 05/00	D	OM611.960	
C 220 T CDI	92	09/97 → 03/01	D	OM611.960	
C 220 T D	55	06/96 → 03/01	D	OM604.910	
C 250 T Turbo-D	110	06/96 → 03/01	D	OM605.960	

**Classe C II (W203), Station Wagon (S203), Coupé (CL203)**

C 200 CDI	75	02/01 → 02/07	D	OM646.962	
	85	03/01 → 08/07	D	OM611.962	
	85	09/00 → 02/07	D	OM611.962	
	90	04/03 → 02/07	D	OM646.962	
C 220 CDI	100	03/01 → 01/04	D	OM611.962	
	100	05/00 → 02/07	D	OM611.962	
	105	03/01 → 08/07	D	OM611.962	
	105	05/00 → 02/07	D	OM611.962	
	110	02/03 → 02/07	D	OM646.963	
	100	08/06 → 08/07	D	OM646.963	
C 270 CDI	120	12/00 → 02/07	D	OM612.962	
	125	03/01 → 08/07	D	OM612.962	
	125	12/00 → 02/07	D	OM612.962	

**Classe E II (W210), Station Wagon (S210)**

E 200 CDI	85	07/99 → 03/02	D	OM611.961	
	75	06/98 → 03/02	D	OM611.961	

82088

350982088000



**MERCEDES-BENZ**

**Classe E II (W210), Station Wagon (S210)**

E 220 CDI	100	07/99 → 03/02	D	OM611.961
	105	07/99 → 03/02	D	OM611.961
	92	06/98 → 07/99	D	OM611.961
E 220 T CDI	100	05/99 → 03/03	D	OM611.961
	105	07/99 → 03/03	D	OM611.961
	92	06/98 → 07/99	D	OM611.961
E 270 CDI	120	07/99 → 03/02	D	OM612.961
	125	07/99 → 03/02	D	OM612.961
E 270 T CDI	120	02/00 → 03/03	D	OM612.961
	125	07/99 → 03/03	D	OM612.961

**Classe G (W460, W461), Cabrio (W463)**

G 270 CDI	115	01/03 →	D	OM612.966
-----------	-----	---------	---	-----------

**Classe M I (W163)**

ML 270 CDI	120	12/99 → 06/05	D	OM612.963
------------	-----	---------------	---	-----------

**CLK II (C209), Cabrio (A209)**

270 CDI	120	02/03 → 06/05	D	OM612.967
270 CDI	125	10/02 → 05/09	D	OM612.962, OM612.967

82089

350982089000



**PULEGGIA**

Diametro Puleggia	Ø59.85
Numero Denti/Gole Puleggia	20
Altezza Puleggia	32.3
Posizione Attacco	62
Diametro Girante	Ø61.5
N° Alette Girante	8
Posizione Girante	22.2



**CITROËN**

**C 4 I, Coupé, Picasso, Grand Picasso**

1.8 Bifuel	92	01/09 → 10/12	BF	6FY (EW7A)	(+)COP
	92	01/09 → 10/12	BF	6FY (EW7A)	
1.8 i 16V	92	10/06 →	B	6FY (EW7A)	(+)COP
	92	10/06 →	B	6FY (EW7A)	
2.0 16V	100	11/04 → 07/07	B	RFN (EW10J4)	(+)COP
	100	11/04 → 07/07	B	RFN (EW10J4)	
	103	11/04 → 07/11	B	RFJ (EW10A)	(+)COP
	103	11/04 → 07/11	B	RFJ (EW10A)	
	130	11/04 → 12/10	B	RFK (EW10J4S)	(+)COP
	130	11/04 → 12/10	B	RFK (EW10J4S)	

82089

350982089000



**CITROËN**

**C 4 I, Coupé, Picasso, Grand Picasso**

2.0 i 16V	103	10/06 →	B	RFJ (EW10A)	(+)COP
	103	10/06 →	B	RFJ (EW10A)	
2.0 VTR	103	10/06 → 12/07	B	RFJ (EW10A)	(+)COP

**C 5 I, Break**

1.8 16V	85	03/01 → 08/04	B	6FZ (EW7J4)	(+)COP
	85	03/01 → 08/04	B	6FZ (EW7J4)	
2.0 16V	100	03/01 → 08/04	B	RFN (EW10J4)	(+)COP
	100	03/01 → 08/04	B	RFN (EW10J4)	
2.0 16V HPi	103	03/01 → 08/04	B	RLZ (EW10D)	(+)COP
	103	03/01 → 08/04	B	RLZ (EW10D)	

**C 5 II, Break**

1.8 16V	92	09/05 →	B	6FY (EW7A)	(+)COP
	92	09/05 →	B	6FY (EW7A)	
	85	09/04 →	B	6FZ (EW7J4)	(+)COP
2.0 16V	85	09/04 →	B	6FZ (EW7J4)	
	103	09/04 →	B	RFJ (EW10A)	(+)COP
	103	09/04 →	B	RFJ (EW10A)	

C 5 III, Break 1.8 16V	92	02/08 →	B	6FY (EW7A)	(+)COP
------------------------	----	---------	---	------------	--------

1.8 16V	92	02/08 →	B	6FY (EW7A)	
2.0 16V	103	02/08 →	B	RFJ (EW10A)	(+)COP
	103	02/08 →	B	RFJ (EW10A)	
2.0 16V BioFlex	103	02/08 →		RFJ (EW10A)	(+)COP
	103	02/08 →		RFJ (EW10A)	

**C 8**

2.0	100	07/02 →	B	RFN (EW10J4)	(+)COP
	100	07/02 →	B	RFN (EW10J4)	
2.0 16V	103	09/05 →	B	RFJ (EW10A)	(+)COP
	103	09/05 →	B	RFJ (EW10A)	
	104	09/05 →	B	RFJ (EW10A)	(+)COP
	104	09/05 →	B	RFJ (EW10A)	
2.2	116	07/02 →	B	3FZ (EW12J4)	(+)COP
	116	07/02 →	B	3FZ (EW12J4)	

**Evasion**

2.0 16V	100	05/00 → 07/02	B	RFN (EW10J4)	(+)COP
	100	05/00 → 07/02	B	RFN (EW10J4)	

**Jumpy I**

2.0	100	04/00 → 12/06	B	RFN (EW10J4)	(+)COP
	100	04/00 → 12/06	B	RFN (EW10J4)	
2.0 i 16V	102	03/00 →	B	RFN (EW10J4)	(+)COP
	102	03/00 →	B	RFN (EW10J4)	

**82089 350982089000**

**CITROËN**
**Jumpy II**

2.0	100	12/03 → 10/06	B	RFN(EW10J4)	(+)COP
	100	12/03 → 10/06	B	RFN(EW10J4)	

**Jumpy III**

2.0 i	103	01/07 →	B	RFH(EW10A)	(+)COP
	103	01/07 →	B	RFH(EW10A)	

**Xsara, Break, Coupé, Picasso, Van**

1.8 16V	85	02/00 →	B	6FZ(EW7J4)	(+)COP
	85	02/00 →	B	6FZ(EW7J4)	
1.8 VTS	85	09/00 → 10/04	B	6FZ(EW7J4)	(+)COP
	85	09/00 → 10/04	B	6FZ(EW7J4)	
2.0 16V	100	09/00 → 03/05	B	RFN(EW10J4)	(+)COP
	100	09/00 → 03/05	B	RFN(EW10J4)	

**FIAT**
**Doblo II, Cargo**

1.4	70	04/10 →	B	843A1.000	(+)COP
	70	04/10 →	B	843A1.000	

**Scudo I**

2.0	100	05/00 → 12/06	B	RFN(EW10J4)	(+)COP
	100	05/00 → 12/06	B	RFN(EW10J4)	
2.0 16V	100	06/00 → 12/06	B	RFN(EW10J4)	(+)COP
	100	06/00 → 12/06	B	RFN(EW10J4)	

**Ulysse II**

2.0	100	08/02 → 06/11	B	RFN(EW10J4)	(+)COP
	100	08/02 → 06/11	B	RFN(EW10J4)	

**LANCIA**
**Phedra**

2.0	100	09/02 → 11/10	B	RFN(EW10J4)	(+)COP
	100	09/02 → 11/10	B	RFN(EW10J4)	

**Zeta**

2.0 16V	100	07/00 → 09/02	B	RFN	(+)COP
	100	07/00 → 09/02	B	RFN	

**PEUGEOT**
**205 II, Van**

2.0 RC	130	07/03 →	B	RFK(EW10J4S)	(+)COP
	130	07/03 →	B	RFK(EW10J4S)	
2.0 S16	99	04/99 → 10/00	B	RFR(DEV10J4)	(+)COP
	99	04/99 → 10/00	B	RFR(DEV10J4)	
	100	06/99 →	B	RFN(EW10J4)	(+)COP
	100	06/99 →	B	RFN(EW10J4)	

**82089 350982089000**

**PEUGEOT**
**206, CC, Van**

2.0 16V	100	07/02 →	B	RFN(EW10J4)	(+)COP
	100	07/02 →	B	RFN(EW10J4)	
2.0 S16	100	09/00 →	B	RFN(EW10J4)	(+)COP
	100	09/00 →	B	RFN(EW10J4)	

**307, Station Wagon, CC**

2.0	100	03/02 →	B	RFN(EW10J4)	(+)COP
	100	03/02 →	B	RFN(EW10J4)	
	105	08/08 →	B	RFN(EW10J4)	(+)COP
	105	08/08 →	B	RFN(EW10J4)	
2.0 16V	100	08/00 →	B	RFN(EW10J4)	(+)COP
	100	08/00 →	B	RFN(EW10J4)	
	103	03/05 →	B	RFJ(EW10A)	(+)COP
	103	03/05 →	B	RFJ(EW10A)	
	103	03/05 →	B	RFJ(EW10A), RFN(EW10J4)	(+)COP
	103	03/05 →	B	RFJ(EW10A), RFN(EW10J4)	
	130	06/05 →	B	RFK(EW10J4S)	(+)COP
	130	06/05 →	B	RFK(EW10J4S)	

**308 I, Station Wagon, CC**

2.0 Bioflex	103	01/08 → 01/12		RFJ(EW10A)	(+)COP
	103	01/08 →		RFJ(EW10A)	
2.0 CVVT	103	07/09 → 11/14	B	RFJ(EW10A)	(+)COP

**407, Station Wagon, Coupé**

1.8	85	05/04 →	B	6FZ(EW7J4)	(+)COP
	85	05/04 →	B	6FZ(EW7J4)	
1.8 16V	92	09/05 →	B	6FY(EW7A)	(+)COP
	92	09/05 →	B	6FY(EW7A)	
2.0	100	05/04 →	B	RFN(EW10J4)	(+)COP
	100	05/04 →	B	RFN(EW10J4)	

**82089**
**350982089000**

**PEUGEOT**
**407, Station Wagon, Coupé**

2.0 16V	99	01/99 → 08/00	B	RFR (DEW10J4)	(+)COP	
	99	01/99 → 08/00	B	RFR (DEW10J4)		
	100	08/00 → 06/04	B	RFN (EW10J4)	(+)COP	
	100	08/00 → 06/04	B	RFN (EW10J4)		
	100	10/00 → 12/04	B	RFN (EW10J4), RFV (XU10J4R)	(+)COP	
	100	10/00 → 12/04	B	RFN (EW10J4), RFV (XU10J4R)		
	103	09/05 →	B	RFJ (EW10A)	(+)COP	
	103	09/05 →	B	RFJ (EW10A)		
	97	11/95 → 05/04	B	RFV (XU10J4R)	(+)COP	
	97	11/95 → 05/04	B	RFV (XU10J4R)		
	2.0 16V HPi	103	05/01 → 05/04	B	RLZ (EW10D)	(+)COP
	2.0 Bioflex	103	09/07 →		RFJ (EW10A)	(+)COP
		103	09/07 →		RFJ (EW10A)	
	2.2	116	07/00 → 05/04	B	3FZ (EW12J4)	(+)COP
	116	07/00 → 05/04	B	3FZ (EW12J4)		
2.2 16V	120	09/05 →	B	3FY (EW12J4)	(+)COP	
	120	09/05 →	B	3FY (EW12J4)		
<b>607</b>						
2.0	100	02/00 →	B	RFN (EW10J4)	(+)COP	
	100	02/00 →	B	RFN (EW10J4)		
2.2 16V	116	02/00 →	B	3FZ (EW12J4)	(+)COP	
	116	02/00 →	B	3FZ (EW12J4)		
	120	09/05 →	B	3FY (EW12J4)	(+)COP	
	120	09/05 →	B	3FY (EW12J4)		
<b>806</b>						
2.0 16V	100	09/00 → 08/02	B	RFN (EW10J4)	(+)COP	
	100	09/00 → 08/02	B	RFN (EW10J4)		
<b>807</b>						
2.0	100	06/02 →	B	RFN (EW10J4)	(+)COP	
	100	06/02 →	B	RFN (EW10J4)		
2.0 16V	103	09/05 →	B	RFJ (EW10A)	(+)COP	
	103	09/05 →	B	RFJ (EW10A)		

**82089**
**350982089000**

**PEUGEOT**
**807**

2.2	116	06/02 →	B	3FZ (EW12J4)	(+)COP
	116	06/02 →	B	3FZ (EW12J4)	
<b>Expert I</b>					
2.0	100	07/00 →	B	RFN (EW10J4)	(+)COP
	100	07/00 →	B	RFN (EW10J4)	
<b>Expert II, Tepee</b>					
2.0 16V	103	01/07 →	B	RFH (EW10A), RFJ (EW10A)	(+)COP
	103	01/07 →	B	RFH (EW10A), RFJ (EW10A)	

**82090**
**350982090000**

**DACIA**
**Logan**

1.2	54	05/15 →	B		
	55	10/12 →	B	D4F732	
1.2 LPG	55	10/12 →		D4F734	

**Logan MCV**

1.2	54	05/15 →	B	D4F732	
	55	02/13 →	B	D4F732	
1.2 LPG	55	02/13 →		D4F734	

**Logan, Station Wagon, Van**

1.2 16V	55	02/06 →	B	D4F732	
1.2 16V LPG	55	02/06 →		D4F734	

**Sandero I**

1.2 16V LPG	55	11/08 →		D4F732	
-------------	----	---------	--	--------	--

**Sandero II**

1.2	54	05/15 →	B	D4F732	
	55	10/12 →	B	D4F732	
1.2 LPG	55	10/12 →		D4F732	

**82090**
**350982090000**

**KW**

**RENAULT**
**Clio II**

1.2 16V	55	06/01 →	B	D4F706, D4F712, D4F714, D4F722, D4F728	06-2003 →
---------	----	---------	---	--	-----------

**Clio III, Grandtour**

1.2	57	10/05 →	B	D4F764	
1.2 16V	58	06/05 →	B	D4F764	
	76	09/10 →	B	D4F786	
	48	06/05 →	B	D4F740	
	55	06/05 →	B	D4F706, D4F740	
1.2 16V Hi-Flex	55	02/08 →	B	D4F740	
	58	02/08 →	B	D4F764	
	74	02/08 →	B	D4F784	
1.2 16V Hi-Flex	55	07/08 →		D4F740	
	55	07/08 →		D4F740, D4F742	
1.2 Ethanol	55	07/08 →			

**Clio IV, Grandtour**

1.2 16V	54	11/12 →	B	D4F728, D4F740	
	54	01/13 →	B	D4F740	

**Modus**

1.2	76	04/11 →	B	D4F786	
-----	----	---------	---	--------	--

**Thalia II**

1.2 16V	55	09/08 →	B	D4F728	
---------	----	---------	---	--------	--

**Twingo II**

1.2 16V	55	03/07 →	B	D4F764, D4F770, D4F772	
	56	03/07 →	B	D4F772	
1.2 TCe 100	75	02/11 →	B	D4F780, D4F782	
1.2 Turbo	74	03/07 →	B	D4F780, D4F782	

**Wind**

1.2 TCe 100	75	02/11 →	B	D4F780	
-------------	----	---------	---	--------	--

**82091**
**350982091000**

**PULEGGIA**

Diametro Puleggia	Ø56.2
Altezza Puleggia	Ø30.3
Posizione Attacco	56
Diametro Girante	Ø60
N° Alette Girante	6
Posizione Girante	4.5

**KW**

**RENAULT**
**Clio II**

1.2	43	09/98 →	B	D7F720, D7F726, D7F746, D7F764, D7F766	01-2004 →
-----	----	---------	---	--	-----------

**Kangoo I, Van**

1.2 BiFuel	43	07/98 → 07/01	BF	D7F710, D7F744	
------------	----	---------------	----	-------------------	--

**Twingo I**

1.2 LPG	44	10/03 →		D7F702, D7F708	
---------	----	---------	--	-------------------	--

**Twingo II**

1.2	43	03/07 →	B	D7F800	
-----	----	---------	---	--------	--

**82092**
**350982092000**

**PULEGGIA**

Diametro Puleggia	Ø56.4
Numero Denti/Gole Puleggia	19
Altezza Puleggia	34.8
Posizione Attacco	89.6
Diametro Girante	Ø68.8
N° Alette Girante	6
Posizione Girante	4.5

**KW**

**MAZDA**
**3 I, Saloon**

2.0 MZR-CD	105	12/06 → 06/09	D	RF7J	
------------	-----	---------------	---	------	--

**5 I**

2.0 CD	81	03/05 →	D	RF7J	
	105	06/05 →	D	RF7J	

**6 I, Hatchback, Station Wagon**

2.0 CiTD 4x4	89	10/02 → 02/05	D	RF5C	
	100	10/02 → 02/05	D	RF5C	
2.0 DI	89	08/02 → 08/07	D	RF5C	
	100	06/02 → 08/07	D	RF5C	
	105	06/05 → 08/07	D	RF7J	

**82092**
**350982092000**

**KW**

**MAZDA**
**6 II, Hatchback, Station Wagon**

2.0 MZR-CD 103 08/07 → D RF7J

**323 F VI**

2.0 TD 66 09/98 → 12/01 D

74 01/01 → 05/04 D RF4F

**323 S VI**

2.0 DiTD 74 10/00 → 10/02 D RF4F

2.0 TD 66 09/98 → 05/04 D RF3F

**626 V, Hatchback, Station Wagon**

2.0 Di TD 66 04/98 → 10/02 D RF3F

2.0 DiTD 66 04/98 → 10/02 D RF3F

2.0 TD 81 10/00 → 10/02 D RF59

81 10/00 → 10/02 D

2.0 Turbo Di 74 04/98 → 10/02 D RF4F

74 04/98 → 10/02 D

**MPV**

2.0 Di 100 07/02 → 02/06 D RF5C

**Premacy**

2.0 TD 66 10/99 → 07/00 D RF3F

74 07/00 → 03/05 D RF4F

**82093**
**350982093000**

**PULEGGIA**

Diametro Puleggia Ø102.6  
 Altezza Puleggia 32.5  
 Posizione Attacco 51.6  
 Diametro Girante Ø62  
 N° Alette Girante 7  
 Posizione Girante 23.5

**KW**

**HONDA**
**Accord VII, Aerodeck, Hatchback, Coupé**

2.2 i-CTDi 103 01/04 → 05/08 D N22A1

**Civic VIII, Hatchback, Coupé**

2.2 CTDi 103 09/05 → D N22A2

**CR-V II**

2.2 CTDi 103 02/05 → 09/06 D N22A2

**CR-V III**

2.2 i-CTDi 4WD 103 01/07 → D N22A2

**FR-V**

2.2 i CTDi 103 07/05 → D N22A1

**82094**
**350982094000**

**PULEGGIA**

Diametro Puleggia Ø105.1  
 Numero Denti/Gole Puleggia 6  
 Altezza Puleggia 22.8  
 Posizione Attacco 83.9  
 Diametro Girante Ø83  
 N° Alette Girante 7  
 Posizione Girante 18.2

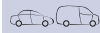
**KW**

**CITROËN**
**Jumper III**

3.0 HDi 145 107 07/10 → D F1CE3481N

3.0 HDi 155 115 07/10 → D F1CE0481D (F30DT)

3.0 HDi 160 116 09/06 → D F1CE0481D (F30DT)

3.0 HDi 180 130 07/11 → D F1CE0481D (F30DT)

**FIAT**
**Ducato V**

115 Multijet 2,0 D 85 06/11 → D 250A1.000, 250A2.000

140 Natural Power 100 04/09 → F1CE0441A

140 Natural Power 100 04/09 → F1CE0441A, F1CFA401A

150 Multijet 3,0 D 107 04/10 → D F1CE3481N

160 Multijet 3,0 D 115 10/06 → D F1CE0481D

115 07/06 → D F1CE3481M

116 07/06 → D F1CE0481D

116 07/06 → D F1CE0481D, F1CE3481M

180 Multijet 3,0 D 130 06/11 → D F1CE3481E

**PEUGEOT**
**Boxer III**

3.0 HDi 115 07/06 → D F1CE0481D (F30DT)

3.0 HDi 145 107 04/10 → D

3.0 HDi 160 116 04/06 → D F1CE0481D (F30DT)

3.0 HDi 175 130 03/11 → D F1CE0481D (F30DT)



**82095**
**350982095000**

**ALBERINO**

Diametro Alberino M30×1.5  
 Tipo Filetto Alberino MASCHIO  
 Posizione Attacco 144.9  
 Diametro Girante Ø83.8  
 N° Alette Girante 7  
 Posizione Girante 17.2

**KW**

**IVECO**
**Daily III**

35 C 14	100	09/04 → 04/06	D	F1CE0481A
35 C 14, 35 S 14	100	01/05 → 04/06	D	F1AE0481M
35 C 17, 35 S 17	122	01/05 → 04/06	D	F1CE0481B
40 C 14	100	09/04 → 04/06	D	F1CE0481A
40 C 17, 40 S 17	122	01/05 → 04/06	D	F1CE0481B
50 C 14	100	09/04 → 04/06	D	F1CE0481A
50 C 17	122	09/04 → 04/06	D	F1CE0481B
65 C 14	100	09/04 → 04/06	D	F1CE0481A
65 C 17	122	09/04 → 04/06	D	F1CE0481B

**Daily IV**

35C15	107	05/06 → 08/11	D	F1CE0481FA
35C15 V, 35C15 V/P	107	05/06 → 08/11	D	F1CE0481FA
35C18	130	05/06 → 08/11	D	F1CE0481HA
35C18 V, 35C18 V/P, 35S18 V, 35S18 V/P	130	05/06 → 08/11	D	F1CE0481HA
35C18, 35S18	130	05/06 → 08/11	D	F1CE0481HA
40C15	107	05/06 → 08/11	D	F1CE0481FA
40C15 V, 40C15 V/P	107	05/06 → 08/11	D	F1CE0481FA
40C18	130	05/06 → 08/11	D	F1CE0481HA
40C18 V, 40C18 V/P	130	05/06 → 08/11	D	F1CE0481HA
45C15	107	05/06 → 08/11	D	F1CE0481FA
45C15 V	107	05/06 → 08/11	D	F1CE0481FA
45C18	130	05/06 → 08/11	D	F1CE0481HA
45C18, 45C18 /P, 45C18 D, 45C18 D/P	130	05/06 → 08/11	D	F1CE0481HA

**82095**
**350982095000**

**KW**

**IVECO**
**Daily IV**

50C15	107	05/06 → 08/11	D	F1CE0481FA
50C15 V, 50C15 V/P	107	05/06 → 08/11	D	F1CE0481FA
50C18	130	05/06 → 08/11	D	F1CE0481HA
50C18 V, 50C18 V/P	130	05/06 → 08/11	D	F1CE0481HA
60C15	107	05/06 → 08/11	D	F1CE0481FA
60C15 V	107	05/06 → 08/11	D	F1CE0481FA
60C15, 60C15 /P, 60C15 D, 60C15 D/P	107	05/06 → 08/11	D	F1CE0481FA
60C18	130	05/06 → 08/11	D	F1CE0481HC
65C15	107	05/06 → 08/11	D	F1CE0481FA
65C15, 65C15 /P, 65C15 D, 65C15 D/P	107	05/06 → 08/11	D	F1CE0481FA
65C18	130	05/06 → 08/11	D	F1CE0481HC

**82097**
**350982097000**

**FLANGIA**

Numero Fori Flangia 3  
 Dimensione Fori Flangia M8×1.25  
 Posizione Attacco 76.2  
 Diametro Centraggio Ø30  
 Diametro Girante Ø59.5  
 N° Alette Girante 7  
 Posizione Girante -1

**KW**

**AUDI**
**A1, Sportback**

1.4 TFSI	90	05/10 →	B	CAXA, CNVA
1.4 TFSI	136	11/11 →	B	CAVG, CTHG, CTJA

**A3 II, Sportback, Cabriolet**

1.4 TFSI	92	02/11 → 05/13	B	CAXC
	92	09/07 → 08/12	B	CAXC, CMSA

**82097**
**350982097000**

**SEAT**
**Altea, Altea XL**

1.4 TSI 92 11/07 → B CAXC

Leon II 10.4 TSI 92 11/07 → 12/12 B CAXC

**Toledo IV**

1.4 TSI 90 07/12 → B CAXA

**SKODA**
**Octavia II, Station Wagon**

1.4 TSI 90 11/08 → 06/13 B CAXA

**Rapid II**

1.4 TSI 90 07/12 → B CAXA

**Superb II, Station Wagon**

1.4 TSI 92 07/08 → 05/15 B CAXC

**Yeti**

1.4 TSI 90 06/10 → B CAXA

**VOLKSWAGEN**
**Eos**

1.4 TSI 118 05/08 → B CAVD, CTHD

**Golf V, Plus, Variant**

1.4 TSI 90 06/07 → 12/13 B CAXA

**Golf VI, Variant, Cabrio**

1.4 TSI 90 10/08 → 11/12 B CAXA

**Jetta III**

1.4 TSI 90 05/07 → 10/10 B CAXA

**Jetta IV**

1.4 TSI 90 05/11 → B CAXA, CMSB

**Passat VI, Variant, CC**

1.4 TSI 90 05/07 → 07/10 B CAXA

**Passat VII, Variant, CC, AllTrack**

1.4 TSI 90 08/10 → 12/14 B CAXA

**Scirocco III**

1.4 TSI 90 08/08 → B CAXA, CMSB

**Tiguan I**

1.4 TSI 90 08/10 → B CAXA

**82098**
**350982098000**

**PULEGGIA**

Diametro Puleggia	Ø52
Altezza Puleggia	33.5
Posizione Attacco	52.3
Diametro Girante	Ø67
N° Alette Girante	12
Posizione Girante	9.5

**DACIA**
**Dokker**

1.5 dCi	55	11/12 →	D	K9K612
	66	11/12 →	D	K9K612

**Dokker Express**

1.5 dCi	55	12/12 →	D	K9K612
	66	12/12 →	D	K9K612

**Duster**

1.5 dCi	66	10/10 →	D	K9K884, K9K892
	80	08/13 →	D	K9K856
1.5 dCi 4x4	66	10/10 →	D	K9K884, K9K894
	80	08/13 →	D	K9K858
	81	10/10 →	D	K9K898

**Lodgy**

1.5 dCi	66	03/12 →	D	K9K612
	79	01/13 →	D	K9K846
	80	06/15 →	D	
	66	10/12 →	D	K9K612

**Logan MCV**

1.5 dCi	55	05/10 →	D	K9K892
	65	05/10 →	D	K9K892

**Logan, Station Wagon, Van**

1.5 dCi	55	05/10 →	D	K9K892
	65	05/10 →	D	K9K892
	55	05/10 →	D	K9K892
	65	05/10 →	D	K9K892

**Sandero I**

1.5 dCi	55	05/10 →	D	K9K892
	65	05/10 →	D	K9K892

**INFINITI**
**Q30**

1.5 D	80	11/15 →	D	
-------	----	---------	---	--

**82098 350982098000**

**MERCEDES-BENZ**
**Citan**

108 CDI	55	11/12 →	D	OM607.951
109 CDI	66	11/12 →	D	OM607.951
	66	11/12 →	D	OM607.951

**CLA**

CLA 180 CDI / d	80	10/13 →	D	OM607.951
CLA 180 d	80	07/15 →	D	OM607.951

**Classe A III (W176)**

A 160 CDI / d	66	06/13 →	D	OM607.951
A 180 CDI / d	80	06/12 →	D	OM607.951

**Classe B II (W246)**

B 160 CDI / d	66	05/13 →	D	OM607.951
B 180 CDI / d	80	02/13 →	D	OM607.951

**Classe GLA (X156)**

GLA 180 CDI / d	80	07/14 →	D	OM607.951
-----------------	----	---------	---	-----------

**NISSAN**
**Cube III**

1.5 dCi	78	03/10 →	D	K9K, K9K270
	81	03/10 →	D	K9K, K9K270

**Juke**

1.5 dCi	81	06/10 →	D	K9K636, K9K896
---------	----	---------	---	----------------

**Note II**

1.5 dCi	66	06/13 →	D	K9K892
---------	----	---------	---	--------

**Pulsar**

1.5 dCi	81	10/14 →	D	K9K
---------	----	---------	---	-----

**Qashqai II**

1.5 dCi	81	11/13 →	D	K9K636
---------	----	---------	---	--------

**RENAULT**
**Captur**

1.5 dCi 110	81	01/15 →	D	K9K646
-------------	----	---------	---	--------

**Clio III, Grandtour**

1.5 dCi	55	08/10 →	D	K9K770
	65	08/10 →	D	K9K770
	65	08/10 →	D	K9K770, K9K772

**Clio IV, Grandtour**

1.5 dCi 75	55	01/13 →	D	K9K612
1.5 dCi 90	66	01/13 →	D	K9K608

**Fluence**

1.5 dCi	66	02/10 →	D	K9K834
	81	02/10 →	D	K9K836, K9K837

**82098 350982098000**

**RENAULT**
**Grand Scénic III**

1.5 dCi	70	11/10 →	D	K9K846
	81	04/09 →	D	K9K636, K9K836, K9K837

**Kadjar**

1.5 dCi 110	81	06/15 →	D	K9K646, K9K647
-------------	----	---------	---	----------------

**Kangoo II, Be Bop, Van**

1.5 dCi	66	11/12 →	D	K9K808
	80	06/09 →	D	K9K804
	66	06/09 →	D	K9K808
1.5 dCi 110	80	09/10 →	D	K9K804
	81	03/13 →	D	K9K636

1.5 dCi 75	55	09/10 →	D	K9K608, K9K808
	55	09/10 →	D	K9K802
1.5 dCi 90	66	06/09 →	D	K9K608, K9K808

**Laguna III, Grantour, Coupé**

1.5 dCi	81	03/12 →	D	K9K846
---------	----	---------	---	--------

**Latitude**

1.5 dCi	81	07/10 →	D	K9K782
---------	----	---------	---	--------

**Megane III, Station Wagon, Coupé, CC**

1.5 dCi	66	05/09 →	D	K9K834
	66	11/08 →	D	K9KH834
	81	02/09 →	D	K9K636, K9K656, K9K657, K9K836, K9K837, K9K846
				K9K636, K9K836, K9K837, K9K846
				K9K636, K9K837, K9K846, K9KJ836
	81	02/09 →	D	K9K636, K9K836, K9K837, K9K846
	81	02/09 →	D	K9K636, K9K837, K9K846, K9KJ836
				K9K837

**Megane IV**

1.5 dCi 110	81	11/15 →	D	
1.5 dCi 90	66	11/15 →	D	

82098

350982098000



**RENAULT**

**Scénic III**

1.5 dCi	70	11/10 →	D	K9K846
	81	04/09 →	D	K9K636, K9K656, K9K657, K9K836, K9K837

**Twingo II**

1.5 dCi 75	55	10/10 →	D	K9K820
1.5 dCi 90	63	10/10 →	D	K9K820

82099

350982099000



**PULEGGIA**

Diametro Puleggia Ø52  
 Altezza Puleggia 33.5  
 Posizione Attacco 45  
 Diametro Girante Ø72.5  
 N° Alette Girante 20  
 Posizione Girante 14.7



**RENAULT**

**Grand Scénic III**

1.9 dCi	96	02/09 →	D	F9Q870, F9Q872
---------	----	---------	---	-------------------

**Megane III, Station Wagon, Coupé, CC**

1.9 dCi	96	06/10 →	D	F9Q870
1.9 dCi	96	11/08 →	D	F9Q870, F9Q872

**Scénic III**

1.9 dCi	96	02/09 →	D	F9Q870, F9Q872
---------	----	---------	---	-------------------

84000

350984000000



**PULEGGIA**

Diametro Puleggia Ø94  
 Numero Denti/Gole Puleggia 6  
 Altezza Puleggia 23  
 Posizione Attacco 72.5  
 Diametro Girante Ø61.8  
 N° Alette Girante 6  
 Posizione Girante 5.5



**BMW**

**1 I (E81, E87), Coupé (E82), Cabrio (E88)**

116 d	66	01/11 → 12/11	D	N47D20A, N47D20C
	66	01/11 → 12/11	D	N47D20C
	85	12/08 → 09/12	D	N47D20A
	85	11/08 → 09/12	D	N47D20A, N47D20C
118 d	100	11/03 → 09/12	D	M47D20 (204D4), N47D20A, N47D20C
	100	09/06 → 09/12	D	N47D20A, N47D20C
	100	09/09 → 10/13	D	N47D20C
	105	11/03 → 09/12	D	M47D20 (204D4), N47D20A, N47D20C
	105	09/06 → 09/12	D	N47D20A, N47D20C
	105	09/09 → 10/13	D	N47D20C
120 d	120	03/08 → 12/13	D	N47D20A, N47D20C
	130	11/03 → 09/12	D	M47D20 (204D4), N47D20A, N47D20C
	130	09/06 → 09/12	D	N47D20A, N47D20C
	145	03/08 → 12/13	D	N47D20C
123 d	150	03/07 → 09/12	D	N47D20B, N47D20C, N47D20D
	150	03/07 → 09/12	D	N47D20B, N47D20D

**84000 35098400000**

**BMW**
**3 V (E90), Touring (E91), Cabrio (E93), Coupé (E92)**

316 d	85	07/09 → 12/11	D	N47D20C	
	100	07/07 → 12/11	D	N47D20C	
318 d	105	09/07 → 06/12	D	N47D20A, N47D20C	
320 d	120	01/07 → 12/13	D	N47D20C	→ 02-2010
	130	03/07 → 12/13	D	N47D20A	→ 02-2010
	130	09/07 → 12/11	D	N47D20A, N47D20C	
320 d xDrive	135	01/10 → 06/12	D	N47D20C	
	120	07/08 → 12/11	D	N47D20C	
	130	09/08 → 12/11	D	N47D20C	
320 xd	130	09/08 → 12/13	D	N47D20C	→ 02-2010
	135	01/10 → 06/12	D	N47D20C	
	130	03/07 → 12/13	D	N47D20A	
	130	09/07 → 12/11	D	N47D20C	

**5 V (E60), Touring (E61)**

520 d	130	09/07 → 03/10	D	N47D20A, N47D20C	
-------	-----	---------------	---	---------------------	--

**X1 I (E84)**

sDrive 18 d	100	03/09 → 06/15	D	N47D20C	
	105	10/09 → 06/15	D	N47D20C	
sDrive 20 d	120	03/10 → 06/15	D	N47D20C	
	130	10/09 → 06/15	D	N47D20C	
xDrive 18 d	100	03/09 → 06/15	D	N47D20C	
	105	10/09 → 06/15	D	N47D20C	
xDrive 20 d	120	03/10 → 06/15	D	N47D20C	
	130	10/09 → 06/15	D	N47D20C	
xDrive 23 d	150	10/09 → 06/15	D	N47D20C, N47SD20D	

**X3 I (E83)**

2.0 d	130	09/07 → 03/09	D	N47D20A, N47D20C	
xDrive 18 d	105	09/08 → 12/11	D	N47D20C	
xDrive 20 d	120	09/08 → 08/10	D	N47D20C	
	130	09/08 → 08/10	D	N47D20C	

**84001 350984001000**

**PULEGGIA**

Diametro Puleggia	Ø56.2
Numero Denti/Gole Puleggia	19
Altezza Puleggia	28.8
Posizione Attacco	47.5
Diametro Girante	Ø63.4
N° Alette Girante	8
Posizione Girante	47.7

**AUDI**
**A1, Sportback**

1.6 TDI	66	03/11 →	D	CAYB	
	77	05/10 →	D	CAYC	
2.0 TDI	100	05/12 →	D	CFHB	
	105	09/11 →	D	CFHD	

**A3 II, Sportback, Cabriolet**

1.6 TDI	66	05/09 → 08/12	D	CAYB	
	77	05/09 → 08/12	D	CAYC	

**A4 IV, Avant, Allroad**

2.0 TDI	110	05/13 → 12/15	D	CJCD, CMFB, CSUA	
	130	11/11 → 12/15	D	CGLC	
	130	11/11 → 12/15	D	CGLC, CMGB	
2.0 TDI quattro	130	11/11 → 12/15	D	CGLC	

**A5, Sportback, Cabriolet**

2.0 TDI	105	10/11 →	D	CJCA	
	110	05/13 →	D	CJCD	
	130	10/11 →	D	CGLC	
2.0 TDI quattro	130	12/11 →	D	CGLC	

**A6 IV, Avant, Allroad**

2.0 TDI	100	01/12 →	D	CGLC, CSUE	
	120	03/11 →	D	CGLD	
	130	03/11 →	D	CGLC, CMGB	

**Q3**

2.0 TDI	100	09/11 →	D	CFFA	
	103	09/11 →	D	CFFB, CLJA	
	130	05/13 →	D	CFGD	
2.0 TDI quattro	103	01/12 →	D	CFFB	
	120	06/11 →	D	CFGD	
	130	06/11 →	D	CFGD, CLLB	

**Q5**

2.0 TDI	100	11/10 →	D	CJCB, CSUB	
	105	11/10 →	D	CJCA	
	110	05/13 →	D	CJCD, CSUA	

**84001**
**350984001000**

**KW**

**AUDI**
**Q5**

2.0 TDI quattro	100	08/09 →	D	CAGB, CJCB, CSUB	M: 24941
	100	08/09 →	D	CAGB, CJCB, CSUB	
	105	08/09 →	D	CAGA, CJCA	M: 24949
	105	08/09 →	D	CAGA, CJCA	
	110	05/13 →	D	CJCD, CSUA	
	120	11/08 →	D	CAHB, CGLA, CGLD, CNHC	M: 24943, M: 24406
	120	11/08 →	D	CAHB, CGLA, CGLD, CNHC	
	125	11/08 →	D	CAHA, CGLB, CMGA	M: 25767, M: 24948
	125	11/08 →	D	CAHA, CGLB, CMGA	
	130	06/12 →	D	CGLC, CMGB	

**SEAT**
**Alhambra II**

2.0 TDI	85	05/11 →	D	CFFE	
	100	06/10 → 05/11	D	CFFA	
	103	06/10 →	D	CFFB	
	125	06/10 →	D	CFGB	
2.0 TDI 4Drive	130	11/12 →	D	CFGC	
2.0 TDI 4Drive	103	05/11 →	D	CFFB	

**Altea, Altea XL**

1.6 TDI	66	11/10 →	D	CAYB	
	77	10/09 →	D	CAYC	
2.0 TDI 16V 4x4	103	10/10 →	D	CFHC	

**Ibiza V**

1.2 TDI	55	05/10 →	D	CFWA	
1.6 TDI	66	05/09 →	D	CAYB	
	77	05/09 →	D	CAYC, CLNA	
2.0 TDI	105	01/10 →	D	CFHD	

**Leon II**

1.6 TDI	66	11/10 → 12/12	D	CAYB	
	77	02/10 → 12/12	D	CAYC	

**Toledo IV**

1.6 TDI	77	07/12 →	D	CAYC, CLNA	
---------	----	---------	---	------------	--

**84001**
**350984001000**

**KW**

**SKODA**
**Fabia II, Station Wagon, Van**

1.2 TDI	55	05/10 → 12/14	D	CFWA	
	55	04/10 → 12/14	D	CAYA	
1.6 TDI	66	03/10 → 12/14	D	CAYB	
	77	03/10 → 12/14	D	CAYC	

**Octavia II, Station Wagon**

1.6 TDI	77	06/09 → 04/13	D	CAYC	
1.6 TDI 4x4	77	06/09 → 02/13	D	CAYC	
2.0 TDI	81	03/10 → 06/13	D	CFHF, CLCA	
2.0 TDI 16V 4x4	103	05/10 → 02/13	D	CFHC	
2.0 TDI 4x4	81	05/11 → 02/13	D	CFHF	

**Rapid II**

1.6 TDI	66	08/13 →	D	CAYB	
	77	07/12 →	D	CAYC, CLNA	

**Roomster, Van**

1.2 TDI	55	03/10 → 05/15	D	CFWA	
1.6 TDI	66	03/10 → 05/15	D	CAYB	
	77	03/10 → 05/15	D	CAYC	

**Superb II, Station Wagon**

1.6 TDI	77	09/10 → 05/15	D	CAYC	
2.0 TDI 16V 4x4	103	11/10 → 05/15	D	CFFB	

**Yeti**

1.6 TDI	77	11/10 →	D	CAYC	
2.0 TDI	81	11/09 →	D	CFHA, CLCA	
	103	11/11 →	D	CFHC	
2.0 TDI 4x4	81	11/09 →	D	CFHF	
	103	05/09 →	D	CBDB, CFHC, CLCB	M: CFHC
	103	05/09 →	D	CBDB, CFHC, CLCB	
	125	11/09 →	D	CEGA, CFJA	M: CFJA
	125	11/09 →	D	CEGA, CFJA	

**VOLKSWAGEN**
**Amarok**

2.0 BitDI	120	09/10 →	D	CDCA	
	132	11/11 →	D	CNEA, CSHA	
2.0 BitDI 4motion	120	09/10 →	D	CDCA	
	132	11/11 →	D	CNEA, CSHA	
2.0 TDI	90	09/10 →	D	CDBA, CNFA	
	103	07/12 →	D	CNFB	
2.0 TDI 4motion	90	09/10 →	D	CDBA, CNFA	
	103	06/12 →	D	CNFB	

**84001 350984001000**

**VOLKSWAGEN**
**Beetle II (Maggiolino)**

1.6 TDI	77	10/11 →	D	CAYC	
2.0 TDI	103	04/11 →	D	CFFB, CJAA	

**Caddy III**

1.6 TDI	55	08/10 →	D	CAYE	
	75	08/10 →	D	CAYD	
2.0 TDI	62	11/10 →	D	CFHE	
	81	08/10 →	D	CLCA	
	125	05/12 →	D	CFJA	
2.0 TDI 16V	103	11/10 →	D	CFHC, CLCB	
2.0 TDI 16V 4motion	103	11/10 →	D	CFHC	
2.0 TDI 4motion	62	12/10 →	D	CFHE	
	81	08/10 →	D	CFHF	

**CC**

2.0 TDI	100	11/11 →	D	CFFA	
	103	11/11 →	D	CFFB	
	125	11/11 →	D	CFGB, CLLA	
	130	12/12 →	D	CFGC	
2.0 TDI 4motion	103	11/11 →	D	CFFB	
	125	11/11 →	D	CFGB	
	130	12/12 →	D	CFGC	

**Crafter 30-35, 30-50**

2.0 TDI	80	05/11 →	D	CKTB	
	100	05/11 →	D	CKTC	
	105	10/11 →	D	CKUC	
	120	07/11 →	D	CKUB, CSNA	
2.0 TDI 4motion	120	11/11 →	D	CKUB, CSNA	

**Eos**

2.0 TDI	100	11/10 →	D	CFFA	
---------	-----	---------	---	------	--

**Golf V, Plus, Variant**

1.6 TDI	66	02/09 → 12/13	D	CAYB	
	77	03/09 → 12/13	D	CAYC	

**Golf VI, Variant, Cabrio**

1.6 TDI	66	02/09 → 11/12	D	CAYB	
	77	02/09 → 11/12	D	CAYC	
1.6 TDI 4motion	77	07/09 → 07/13	D	CAYC	
2.0 TDI	81	01/10 → 07/13	D	CLCA	
	100	10/08 → 11/12	D	CBAA, CFFA	M: CFFA
	100	10/08 → 11/12	D	CBAA, CFFA	
	103	11/11 →	D	CFHC	
2.0 TDI 4motion	103	05/09 → 11/12	D	CBAB, CFFB	M: CFFB
	103	05/09 → 11/12	D	CBAB, CFFB	

**84001 350984001000**

**VOLKSWAGEN**
**Jetta III**

1.6 TDI	66	12/09 → 10/10	D	CAYB	
	77	06/09 → 10/10	D	CAYC	

**Jetta IV**

1.6 TDI	77	02/11 →	D	CAYC	
	81	10/10 →	D	CLCA	
2.0 TDI	103	02/11 →	D	CFFB, CFHC, CJAA, CLCB	

**Multivan V**

2.0 BiTDI	132	09/09 →	D	CFCA	
2.0 BiTDI 4motion	132	09/09 →	D	CFCA	
2.0 TDI	62	09/09 →	D	CAAA	
	75	09/09 →	D	CAAB	
	84	05/11 →	D	CAAD	
	100	05/10 →	D	CAAE, CCHB	
	103	09/09 →	D	CAAC, CCHA	
2.0 TDI 4motion	100	05/10 →	D	CAAE, CCHB	
	103	09/09 →	D	CAAC, CCHA	

**Passat VI, Variant, CC**

1.6 TDI	77	08/09 → 07/10	D	CAYC	
2.0 TDI	120	05/08 → 05/11	D	CBBA	

**Passat VII, Variant, CC, AllTrack**

1.6 TDI	77	08/10 → 12/14	D	CAYC	
2.0 TDI	100	08/10 → 12/14	D	CFFA	
	103	08/10 → 12/14	D	CFFB	
	125	08/10 → 12/14	D	CFGB, CLLA	
	130	12/12 → 12/14	D	CFGC	
2.0 TDI 4motion	103	08/10 → 12/14	D	CFFB	
	125	01/12 → 12/14	D	CFGB	
	125	08/10 → 01/13	D	CFGB, CLLA	
	130	01/13 → 12/14	D	CFGC	

**Polo VI (6R)**

1.2 TDI	55	10/09 →	D	CFWA	
1.6 TDI	55	06/09 →	D	CAYA	
	66	06/09 →	D	CAYB	
	77	06/09 →	D	CAYC, CLNA	

**Scirocco III**

2.0 TDI	100	11/10 →	D	CFHB	
	130	01/13 →	D	CFGC	

**84001**
**350984001000**

**KW**

**VOLKSWAGEN**
**Sharan II**

2.0 TDI	85	05/11 →	D	CFFE, CUVA
	100	05/10 →	D	CFFA
	103	05/10 →	D	CFFB
	125	08/10 →	D	CFGB
	130	01/13 →	D	CFGC
2.0 TDI 4motion	100	05/11 → 05/12	D	CFFA
	103	05/11 →	D	CFFB

**Tiguan I**

2.0 TDI	81	05/10 →	D	CFFD
2.0 TDI 4motion	130	11/12 →	D	CFGC

**Touran I**

1.6 TDI	66	05/10 → 05/15	D	CAYB
	77	05/10 → 05/15	D	CAYC
2.0 TDI	81	11/10 → 05/15	D	CFHF, CLCA
	103	05/10 → 05/15	D	CFHC
	125	05/10 → 01/13	D	CFJA
	130	01/13 → 05/15	D	CFJB

**Transporter V**

2.0 BitDI	132	09/09 →	D	CFCA
2.0 BitDI 4motion	132	09/09 →	D	CFCA
2.0 TDI	62	09/09 →	D	CAAA
	75	09/09 →	D	CAAB
	84	05/11 →	D	CAAD
	100	05/10 →	D	CAAE
	100	05/10 →	D	CAAE, CCHB
	103	09/09 →	D	CAAC
2.0 TDI 4motion	103	09/09 →	D	CAAC, CCHA
	100	05/10 →	D	CAAE, CCHB
	103	09/09 →	D	CAAC
	103	09/09 →	D	CAAC, CCHA

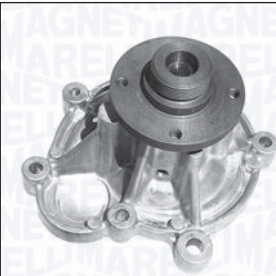
**84002**
**350984002000**

**FLANGIA**

Numero Fori Flangia	4
Dimensione Fori Flangia	M6×1
Posizione Attacco	75.7
Diametro Mozzo	M30×1.5
Diametro Centraggio	Ø35
Diametro Girante	Ø60
N° Alette Girante	6
Posizione Girante	4

**KW**

**MERCEDES-BENZ**
**Sprinter III (906)**

216	115	09/08 →	B	M271.951
316	115	09/08 →	B	M271.951
316 LGT	115	09/08 →		M271.951
	115	09/08 →		M271.951
316 NGT	115	09/08 →		M271.951
516	115	09/08 →	B	M271.951
516 NGT	115	09/08 →		M271.951

**84003**
**350984003000**

**FLANGIA**

Numero Fori Flangia	3
Dimensione Fori Flangia	M6×1
Posizione Attacco	55.2
Diametro Centraggio	Ø25
Diametro Girante	Ø47
N° Alette Girante	8
Posizione Girante	17.7

**KW**

**DACIA**
**Dokker**

1.2 TCe	85	11/12 →	B	H5F402
1.6	61	11/12 →	B	K7M812, K7M828

**Dokker Express**

1.2 TCe 115	84	12/12 →	B	H5F402
1.6	61	12/12 →	B	K7M812, K7M828

**Duster**

1.2 TCe 125	92	10/13 →	B	H5F404
	92	06/15 →	B	H5F404

**Lodgy**

1.2 TCe	85	03/12 →	B	H5F402
1.6	61	03/12 →	B	K7M812, K7M828



**84003**
**350984003000**

**KW**

**DACIA**
**Logan**

TCe 90    66    10/12 →    B    H4B400

**Logan MCV**

TCe 90    66    02/13 →    B    H4B400

**Sandero II**

TCe 90    66    10/12 →    B    H4B400

**NISSAN**
**Cube III**

1.6 16V    81    03/10 →    B    HR16DE

**Juke**

1.2 DIG-T    85    05/14 →    B    HR12DDT

1.6    69    01/13 →    B    HR16DE

1.6    86    06/10 →    B    HR16DE

**Micra III (K12), C+C**

1.6 160 SR    81    08/05 →    B    HR16DE

**Micra IV (K13)**

1.2    56    05/10 →    B    HR12DE

1.2    59    05/10 →    B    HR12DE

1.2 DIG    72    04/11 →    B    HR12DDR

**Note I**

1.6    81    03/06 →    B    HR16DE

**Note II**

1.2    59    06/13 →    B    HR12DE

1.2 DIG    72    06/13 →    B    HR12DDR

1.2 LPG    56    03/15 →    B    HR12DE

**Pulsar**

1.2 DIG-T    85    10/14 →    B    HR12DDT

**Qashqai I**

1.6    84    02/07 →    B    HR16DE

1.6    86    11/10 →    B    HR16DE

**Qashqai II**

1.2 DIG-T    85    11/13 →    B    HR12DDT

**Sentra VII**

1.6    86    08/14 →    B    HR16DE

**Tiida II**

1.6    81    09/07 →    B    HR16DE

**RENAULT**
**Captur**

0.9 TCe 90    66    06/13 →    B    H4B400

1.2 TCe 120    88    06/13 →    B    H5F403

**Clio IV, Grandtour**

0.9 TCe 90    66    01/13 →    B    H4B400

1.2 TCe 120    88    03/13 →    B    H5F403

**84003**
**350984003000**

**KW**

**RENAULT**
**Grand Scénic III**

1.2 TCe    97    01/13 →    B    H5F404

1.4 16V    96    02/09 →    B    H4J700

**Kadjar**

1.2 TCe 130    96    06/15 →    B    H5F408

**Kangoo II, Be Bop, Van**

1.2 TCe 115    84    07/13 →    B    H5F400

**Megane III, Station Wagon, Coupé, CC**

1.2 TCe    97    01/13 →    B    H5F404

1.4 TCe    96    06/10 →    B    H4J700

**Megane IV**

1.2 TCe 100    74    11/15 →    B

1.2 TCe 130    97    11/15 →    B

**Scénic III**

1.2 TCe    97    01/13 →    B    H5F404

1.4 16V    96    02/09 →    B    H4J700

**Twingo III**

0.9 TCe 90    66    09/14 →    B    H4B401

1.0 SCe 70    52    09/14 →    B    H4D400

**SMART**
**ForFour II**

0.9    66    11/14 →    B    M281.910

1.0    45    11/14 →    B    M281.920

1.0    52    07/14 →    B    M281.920

**ForTwo III Coupé, Cabrio**

0.9    66    09/15 →    B    M281.910

1.0    45    11/14 →    B    M281.920

1.0    52    09/15 →    B    M281.920

84004

350984004000



<b>FLANGIA</b>	
Numero Fori Flangia	4
Dimensione Fori Flangia	M6×1
Posizione Attacco	66.6
Diametro Centraggio	Ø22
Diametro Girante	Ø60
N° Alette Girante	6
Posizione Girante	3.8



**MERCEDES-BENZ**

**Classe C II (W203), Station Wagon (S203), Coupé (CL203)**

C 160 Kompressor	90	05/02 → 05/08	B	M271.921
C 180 Kompressor	105	05/02 → 02/07	B	M271.946
C 200 CGI Kompressor	125	07/03 → 02/07	B	M271.942
C 220	120	05/02 → 05/08	B	M271.940
C 230 Kompressor	141	02/04 → 02/07	B	M271.948

**Classe C III (W204), Station Wagon (S204), Coupé (C204)**

C 180	115	06/11 →	B	M271.820
C 180 CGI	115	01/07 → 01/14	B	M271.820
C 180 Kompressor	115	01/08 → 01/14	B	M271.910
	115	01/07 → 01/14	B	M271.952
C 200	137	05/11 → 01/14	B	M271.820
	135	01/07 → 01/14	B	M271.820
C 200 CGI	135	08/07 → 08/14	B	M271.820, M271.860
C 200 Kompressor	135	01/07 → 01/14	B	M271.950
C 250	150	06/11 →	B	M271.860
C 250 CGI	150	07/09 → 01/14	B	M271.860

**Classe CLC**

CLC 160	95	02/09 → 06/11	B	M271.911
CLC 180 Kompressor	105	05/08 → 06/11	B	M271.946
CLC 200 Kompressor	135	05/08 → 06/11	B	M271.957

**Classe E III (W211), Station Wagon (S211)**

E 200 Kompressor	120	11/02 → 12/08	B	M271.941
	135	04/06 → 12/08	B	M271.956
E 200 NGT	120	03/04 → 12/08		M271.941
E 200 T Kompressor	120	03/03 → 07/09	B	M271.941

84004

350984004000



**MERCEDES-BENZ**

**Classe E IV (W212), Station Wagon (S212), Cabrio (A207), Coupé (C207)**

E 200 CGI	135	08/09 →	B	M271.820, M271.860
E 200 NGT	120	03/11 →		M271.958
E 250 CGI	150	01/09 →	B	M271.860

**CLK II (C209), Cabrio (A209)**

200 CGI	125	07/03 → 05/09	B	M271.942
200	120	09/02 → 05/09	B	M271.940
Kompressor	135	10/06 → 05/09	B	M271.955
CLK 200	120	02/03 → 03/10	B	M271.940
Kompressor	135	10/06 → 03/10	B	M271.955

**SLK II (R171)**

200	120	03/04 → 02/11	B	M271.944
Kompressor	135	01/08 → 02/11	B	M271.954
200	135	02/11 →	B	M271.860, M271.861
250	150	02/11 →	B	M271.860, M271.861

84005

350984005000



<b>FLANGIA</b>	
Numero Fori Flangia	3
Dimensione Fori Flangia	M6×1
Posizione Attacco	75
Diametro Girante	Ø75
N° Alette Girante	8
Posizione Girante	5.5



**CHEVROLET**

**Cruze II, Hatchback, Station Wagon**

1.7 D	96	01/12 →	D	LUD
1.7 TD	96	08/12 →	D	LUD

**Trax**

1.7 TD	96	12/12 →	D	LUD
1.7 TDAWD	96	12/12 →	D	LUD

**84005** **350984005000**

**OPEL**
**Astra H, Station Wagon, GTC, Twin Top, Van**

1.7 CDTI	59	03/05 →	D	Z17DTL	
	74	03/04 →	D	Z17DTH	T →: 1874033
	74	03/04 →	D	Z17DTH	
	81	02/07 →	D	A17DTJ, Z17DTJ	
	81	02/07 →	D	Z17DTJ	
	92	02/07 →	D	A17DTR, Z17DTR	

**Astra J, Station Wagon, GTC**

1.7 CDTI	74	10/10 →	D	A17DTL, A17DTN	
	81	10/11 →	D	A17DTC, A17DTE, A17DTJ	
	92	12/09 →	D	A17DTR	
	96	10/11 →	D	A17DTF, A17DTS	

**Corsa D, Van**

1.7 CDTI	92	07/06 →	D	Z17DTR	T →: 1874033
	96	06/10 →	D	A17DTS	T →: 1874033

**Meriva B**

1.7 CDTI	74	06/10 →	D	A17DT	
	81	06/10 →	D	A17DTC, A17DTI	
	96	06/10 →	D	A17DTS	

**Mokka**

1.7 CDTI	96	06/12 →	D	A17DTS	
1.7 CDTI 4x4	96	06/12 →	D	A17DTS	

**Zafira B, Van**

1.7 CDTI	81	01/08 →	D	A17DTJ, Z17DTJ	T →: 1874033
	81	01/08 →	D	A17DTJ, Z17DTJ	
	92	01/08 →	D	A17DTR	T →: 1874033
	92	01/08 →	D	A17DTR	

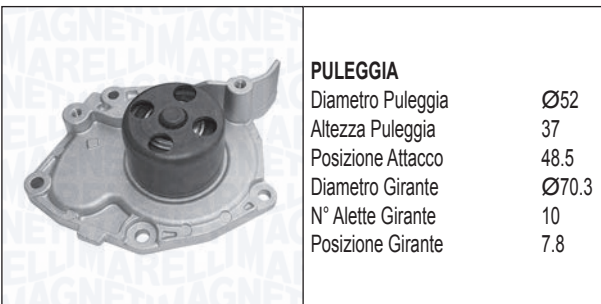
**84006** **350984006000**

**NISSAN**
**Primera III, Hatchback, Station Wagon**

1.9 dCi	88	04/03 →	D	F9Q	
---------	----	---------	---	-----	--

**RENAULT**
**Grand Scénic II**

1.9 dCi	85	05/05 → 01/09	D	F9Q803, F9Q804, F9Q812	
	81	05/05 →	D	F9QE804	
	88	04/04 →	D	F9Q812	
	96	05/05 →	D	F9Q816, F9Q818, F9QEE804, F9QJ803	

**Laguna II, Grantour**

1.9 dCi	68	03/04 →	D	F9Q664	
	81	01/05 →	D	F9Q674, F9Q758	
	96	05/05 →	D	F9Q758, F9Q759	

**Megane II, Station Wagon, Coupé-Cabrio**

1.9 dCi	66	11/02 → 12/05	D	F9Q808	
	68	03/04 → 08/06	D	F9Q808	
	81	05/05 → 03/09	D	F9Q804, F9Q816, F9Q818	
	81	05/05 → 02/08	D	F9Q804, F9Q818	
	85	11/02 → 02/08	D	F9Q804, F9Q816, F9Q818	
	85	05/05 → 07/09	D	F9Q818	
	88	09/03 → 03/09	D	F9Q800	
	96	05/05 → 02/07	D	F9Q803, F9Q804	

**84006** **350984006000**



**RENAULT**

**Megane II, Station Wagon, Coupé-Cabrio**

1.9 dCi	96	05/05 → 12/09	D	F9Q803, F9Q804, F9Q816, F9Q818
	81	05/05 →	D	F9Q803, F9Q804, F9Q816, F9Q818
	88	11/02 → 02/08	D	F9Q800

**Scénic II**

1.9 D	85	06/06 →	D	F9Q812, F9QJ803
1.9 dCi	92	06/03 →	D	F9Q804
	81	05/05 →	D	F9Q804
	88	06/03 →	D	F9Q812
	96	05/05 →	D	F9Q804, F9Q816, F9Q818, F9QJ803

**SUZUKI**

**Grand Vitara II**

1.9 DDiS	95	10/05 → 02/15	D	F9QB
----------	----	---------------	---	------

**84007** **350984007000**

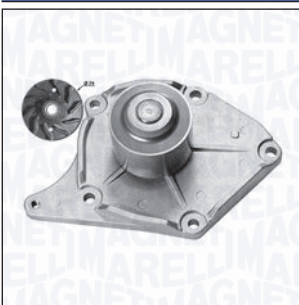

**PULEGGIA**  
 Diametro Puleggia Ø52  
 Altezza Puleggia 32.8  
 Posizione Attacco 50.5  
 Diametro Girante Ø74  
 N° Alette Girante 10  
 Posizione Girante 6.8



**DACIA**

**Duster**

1.5 dCi	63	04/10 →	D	K9K796, K9K830
	79	06/10 →	D	K9K896
1.5 dCi 4x4	79	06/10 →	D	K9K898

**Logan**

1.5 dCi	55	10/12 →	D	K9K612
	63	01/13 →	D	K9K830

**84007** **350984007000**



**DACIA**

**Logan MCV**

1.5 dCi	55	02/13 →	D	K9K612
	63	02/13 →	D	K9K830
	66	02/13 →	D	K9K612
	50	02/07 →	D	K9K792
	63	09/07 →	D	K9K796

**Logan, Station Wagon, Van**

1.5 dCi	48	09/05 →	D	K9K790
	50	01/06 →	D	K9K792
	63	09/07 →	D	K9K796

**Sandero I**

1.5 dCi	50	11/08 →	D	K9K792
	63	11/08 →	D	K9K796

**Sandero II**

1.5 dCi	55	10/12 →	D	K9K612
	63	01/13 →	D	K9K830
	66	10/12 →	D	K9K612

**NISSAN**

**Kubistar**

1.5 dCi 70	50	04/06 → 10/09	D	K9K700, K9K716
1.5 dCi 85	62	04/06 → 10/09	D	K9K276

**Micra III (K12), C+C**

1.5 dCi	50	06/05 → 06/10	D	K9K708
	63	06/05 → 06/10	D	K9K276

**Note I**

1.5 dCi	50	03/06 →	D	K9K700
	63	03/06 →	D	K9K276
	66	09/10 →	D	K9K276
	76	07/08 →	D	K9K292

**NV 200 Evalia, Box**

1.5 dci	63	07/10 →	D	K9K400, K9K608, K9K628
	66	04/11 →	D	K9K892
	81	04/11 →	D	K9K636, K9K646

**Qashqai I**

1.5 dCi	76	07/08 →	D	K9K410
	78	02/07 →	D	K9K732, K9K764
	81	11/10 →	D	K9K430

**Tiida II**

1.5 dCi	78	09/07 →	D	K9K
	78	09/07 →	D	K9K728

**84007 350984007000**

**RENAULT**
**Clio II**

1.5 dCi	74	01/04 →	D	K9K712	
	47	06/05 →	D	K9K740	
	50	08/04 →	D	K9K700, K9K714	
	62	02/07 →	D	K9K718	

**Clio III, Grandtour**

1.5 dCi	47	06/05 →	D	K9K752	
	48	02/10 →	D	K9K752	
	60	11/07 →	D	K9K750	
	50	02/08 →	D	K9K714, K9K768	
	63	02/08 →	D	K9K766	
	76	02/08 →	D	K9K772	
	78	02/08 →	D	K9K764, K9K774	

**Fluence**

1.5 dCi	63	02/10 →	D	K9K830	
	78	02/10 →	D	K9K832	

**Grand Scénic III**

1.5 dCi	63	04/09 →	D	K9K830	
	78	02/09 →	D	K9K832	

**Kangoo I, Van**

1.5 dCi	42	07/03 →	D	K9K704	04-2004 →
	45	04/05 → 06/10	D	K9K700, K9K702	
	62	06/05 →	D	K9K718	
	42	12/02 →	D	K9K704	04-2004 →
	48	12/01 →	D	K9K700, K9K702, K9K704	04-2004 →
	48	12/01 →	D	K9K700, K9K704	04-2004 →
	60	07/02 →	D	K9K702, K9K710	04-2004 →

**Kangoo II, Be Bop, Van**

1.5 dCi	50	02/08 →	D	K9K800	
	50	02/08 →	D	K9K714, K9K800, K9K840	
	63	02/08 →	D	K9K802	
	76	02/08 →	D	K9K804, K9K806	
	76	02/09 →	D	K9K806	
1.5 dCi 110	80	09/10 →	D	K9K804	

**84007 350984007000**

**RENAULT**
**Kangoo II, Be Bop, Van**

1.5 dCi 85	63	02/08 →	D	K9K800, K9K802	
------------	----	---------	---	-------------------	--

**Laguna III, Grantour, Coupé**

1.5 dCi	81	10/07 →	D	K9K780	
---------	----	---------	---	--------	--

**Logan I, Station Wagon**

1.5 dCi	50	04/07 →	D	K9K792	
---------	----	---------	---	--------	--

**Logan I, Station Wagon, Express**

1.5 dCi	50	04/07 →	D	K9K792	
---------	----	---------	---	--------	--

**Megane II, Station Wagon, Coupé-Cabrio**

1.5 dCi	60	08/03 → 05/06	D	K9K722	04-2004 →
	60	09/03 →	D	K9K722	03-2004 →
	63	05/05 → 02/08	D	K9K724	
	74	10/03 → 03/06	D	K9K728, K9K729	
	76	01/07 → 02/08	D	K9K734	
	78	05/05 →	D	K9K732	
	78	05/05 → 06/08	D	K9K732, K9K734	
	60	11/02 → 02/08	D	K9K722	04-2004 →
	76	01/07 → 07/09	D	K9K728	
	76	01/07 → 06/09	D	K9K734	
	78	03/06 → 06/08	D	K9K732	
	78	05/05 → 06/08	D	K9K732, K9K734	

**Megane III, Station Wagon, Coupé, CC**

1.5 dCi	63	12/09 →	D	K9K830	
	78	02/09 →	D	K9K832	
	63	11/08 →	D	K9K830	
	78	02/09 →	D	K9K832	
	78	02/09 →	D	K9K836, K9K846	

**Modus**

1.5 dCi	48	12/04 →	D	K9K752	
	60	09/04 →	D	K9K750	
	76	05/07 →	D	K9K772	
	78	05/05 →	D	K9K764	
1.5 dCi 75	55	10/10 →	D	K9K770	
1.5 dCi 90	65	10/10 →	D	K9K750	

**Scénic II**

1.5 dCi	60	06/03 →	D	K9K722	04-2004 →
	63	05/05 →	D	K9K724	
	74	11/03 →	D	K9K728, K9K729	04-2004 →
	76	01/07 →	D	K9K734	
	78	05/05 →	D	K9K732	

**84007**
**350984007000**

**RENAULT**
**Scénic III**

1.5 dCi	63	04/09 →	D	K9K830
	78	02/09 →	D	K9K832

**Thalia I**

1.5 dCi	47	06/05 →	D	K9K740
	50	02/03 →	D	K9K700, K9K714
	60	06/01 →	D	K9K702

**Thalia II**

1.5 dCi	47	09/08 →	D	K9K740
	48	01/09 →	D	K9K700
	62	09/08 →	D	K9K718

**Twingo II**

1.5 dCi	47	03/07 →	D	K9K740
	62	04/08 →	D	K9K718

**SUZUKI**
**Jimny**

1.5 DDiS 4x4	63	08/05 →	D	K9K266
-----------------	----	---------	---	--------

**84008**
**350984008000**

**FLANGIA**

Posizione Attacco	36.5
Diametro Centraggio	Ø26
Diametro Girante	Ø52.5
N° Alette Girante	6
Posizione Girante	26.8

**ALFA ROMEO**
**Mito**

0.9	74	12/13 →	B	199B6.000
0.9 TwinAir	63	07/11 →	B	312A2.000
	77	04/13 →	B	199B6.000

**CHRYSLER**
**Ypsilon**

0.9 Twinair	63	05/11 →	B	312A2.000
-------------	----	---------	---	-----------

**84008**
**350984008000**

**FIAT**
**500 II, 500C**

0.9	59	12/13 →	B	312A5.000
	63	07/10 →	B	312A2.000
	77	10/13 →	B	199B6.000
	44	12/13 →	B	312A4.000, 312A6.000
48	09/12 →	B	312A4.000	
1.2 LPG	51	12/10 →		169A4.000

**500L**

0.9	77	09/12 →	B	199B6.000
0.9 Natural Power	63	03/13 →		312A2.000

**Panda III, Van**

0.9	57	02/12 →	B	312A2.000, 312A7.000
	59	12/13 →	B	312A5.000
	63	02/12 →	B	312A2.000
	44	12/13 →	B	312A4.000, 312A6.000
48	02/12 →	B	312A4.000	
0.9 4x4	63	09/12 →	B	312A2.000
	66	06/14 →	B	312A7.000
0.9 Natural Power	59	01/15 →		312A2.000
	63	07/12 →		312A2.000

**Punto III, Van**

0.9	74	12/13 →	B	199B6.000
	77	07/13 →	B	199B6.000
0.9 Bifuel	63	03/12 →	BF	312A2.000
0.9 Twinair Turbo	63	03/12 →	B	312A2.000

**LANCIA**
**Ypsilon II**

0.9 CNG	63	05/11 →		312A2.000
0.9 Twinair	59	12/13 →	B	312A2.000, 312A5.000
	63	05/11 →	B	312A2.000

**84009**
**350984009000**

**PULEGGIA**

Diametro Puleggia	Ø54
Altezza Puleggia	37
Posizione Attacco	48.5
Diametro Girante	Ø70.3
N° Alette Girante	10
Posizione Girante	7.8

**KW**

**MITSUBISHI**
**Carisma**

1.9 DI-D	85	09/00 → 06/06	D	F9Q2
	75	09/00 → 06/06	D	F9Q1

**Space Star**

1.9 DI-D	85	10/02 → 12/04	D	F9Q2
	75	02/01 → 12/04	D	F9Q1

**NISSAN**
**Interstar**

dCi 80	60	07/02 →	D	F9Q772
--------	----	---------	---	--------

**Primastar**

2.0	88	02/03 →	B	F4R720
	88	03/01 →	B	F4R720, F4R722
dCi 100	74	03/01 →	D	F9Q760
dCi 80	60	03/01 →	D	F9Q762

**OPEL**
**Movano A**

1.9 DTI	60	10/01 →	D	F9Q772, F9Q774
---------	----	---------	---	-------------------

**Vivaro**

1.9 DI	60	08/01 →	D	F9Q762
	60	08/01 →	D	F9Q762, F9Q774
1.9 DTI	74	08/01 →	D	F9Q760
2.0 16V	88	08/01 →	B	F4R720
2.0 ECOTEC	86	08/06 →	B	F4R820

**RENAULT**
**Avantime**

2.0 16V Turbo	120	11/01 → 05/03	B	F4R760, F4R761
---------------	-----	---------------	---	-------------------

**Clio III, Grandtour**

2.0 16V Sport	145	02/06 →	B	F4R830
	148	09/08 →	B	F4R830

**Duster**

2.0	98	02/12 →	B	F4R403, F4R405
-----	----	---------	---	-------------------

**84009**
**350984009000**

**KW**

**RENAULT**
**Espace IV**

1.9 dCi	85	04/03 → 02/05	D	F9Q820
	88	11/02 →	D	F9Q680, F9Q820, F9Q826
2.0	98	11/02 → 02/05	B	F4R790
	100	11/02 →	B	F4R792
2.0	125	04/05 →	B	F4R796, F4R797, F4R896, F4R897
2.0 Turbo	120	11/02 →	B	F4R794, F4R795, F4R796, F4R797

**Grand Scénic II**

2.0	99	04/04 →	B	F4R770, F4R771
	120	04/04 →	B	F4R776

**Laguna I, Grantour**

1.9 dCi	79	09/99 → 03/01	D	F9Q718
2.0 16V	103	09/99 → 03/01	B	F4R780

**Laguna II, Grantour**

1.8 16V	86	03/01 →	B	F4P770
	89	03/01 →	B	F4P770, F4P774
1.8 16V	85	03/01 →	B	F4P770, F4P771, F4P773, F4P774, F4P775
1.8 16V	85	03/01 →	B	F4P770, F4P771, F4P774, F4P775
1.8 16V	86	03/01 →	B	F4P770, F4P774
1.8 16V	88	03/01 →	B	F4P770, F4P773
1.8 16V	89	03/01 →	B	F4P770, F4P772

**84009**
**350984009000**

**KW**

**RENAULT**
**Laguna II, Grantour**

1.9 dCi	79	03/01 →	D	F9Q718, F9Q754	
	85	09/05 →	D	F9Q750	
	92	09/05 →	D	F9Q750	
	74	10/01 →	D	F9Q752	
	74	10/01 →	D	F9Q754	
	77	06/01 →	D	F9Q752	
	85	08/05 → 09/07	D	F9Q758, F9Q759	
2.0 16V	88	03/01 →	D	F9Q650, F9Q670, F9Q674, F9Q750	
	88	03/01 →	D	F9Q670, F9Q674, F9Q750	
2.0 16V	98	08/02 →	B	F4R714	
	98	10/04 → 09/07	B	F4R714, F4R715	
	125	01/05 →	B	F4R784, F4R786, F4R787	
	150	01/05 →	B	F4R886, F4R887	
	99	08/02 →	B	F4R712, F4R713, F4R714, F4R715	
2.0 16V IDE	103	04/01 →	B	F5R700, F5R701	
2.0 16V Turbo	120	01/03 →	B	F4R764, F4R765, F4R786, F4R787	
<b>Laguna III, Grantour, Coupé</b>					
2.0 16V Turbo	125	10/07 →	B	F4R811	
	125	09/08 →	B	F4R811, F4Rt811	
2.0 GT	150	09/08 →	B	F4R800	
<b>Master II</b>					
1.9 dCi 80	60	11/01 →	D	F9Q772, F9Q774	

**84009**
**350984009000**

**KW**

**RENAULT**
**Megane I, Coach, Cabrio, Scénic, Station Wagon**

1.9 dCi	75	02/01 → 08/03	D	F9Q732, F9Q733	
	75	02/01 → 08/03	D	F9Q732, F9Q733, F9Q738	
<b>Megane II, Station Wagon, Coupé-Cabrio</b>					
2.0	99	09/03 → 12/09	B	F4R770, F4R771	
	102	09/03 → 02/07	B	F4R770	
	169	08/06 → 02/08	B	F4R774	
2.0 16V	99	11/02 → 02/08	B	F4R770	
2.0 16V Turbo	120	05/04 → 02/08	B	F4R776	
2.0 Renault Sport	165	05/04 → 10/09	B	F4R774, F4Rt774	
<b>Megane III, Station Wagon, Coupé, CC</b>					
2.0 R.S.	195	11/08 →	B	F4R874	
2.0 TCe	140	06/12 →	B	F4R872	
	162	09/12 →	B	F4R874	
	132	11/08 →	B	F4R870	
	132	06/10 →	B	F4R870, F4R872	
	184	05/09 →	B	F4R874	
<b>Scénic II</b>					
2.0	99	06/03 →	B	F4R770, F4R771	
2.0 16V Turbo	120	05/04 →	B	F4R776	
<b>Trafic II</b>					
1.9 dCi	59	04/01 → 07/03	D	F9Q762	
	75	03/01 →	D	F9Q760	
1.9 dCi 100	74	03/01 →	D	F9Q760	
1.9 dCi 80	60	03/01 →	D	F9Q760, F9Q762	
	60	03/01 →	D	F9Q762	
2.0	88	03/01 →	B	F4R720	
	88	03/01 →	B	F4R720, F4R722	
2.0 16V	86	08/06 →	B	F4R820	
<b>Vel Satis</b>					
2.0 16 V Turbo	125	04/04 →	B	F4R766, F4R767	
	120	06/02 →	B	F4R762, F4R763	



**84009 350984009000**

**RENAULT**
**Vel Satis**

2.0 Turbo 108 04/05 → B F4R867

**VAUXHALL**
**MOVANO**

 1.9 DTI 59 09/00 → 10/01 D F9Q770  
 60 10/01 → 05/10 D F9Q774

**VIVARO**

 1.9 DI 59 08/01 → 12/06 D F9Q762  
 1.9 DTI 74 08/01 → 12/06 D F9Q760

**VOLVO**
**S 40 I**

 1.9 DI 75 07/00 → 12/03 D D4192T4  
 85 07/00 → 12/03 D D4192T3

**V 40 I**

 1.9 DI 75 07/00 → 06/04 D D4192T4  
 85 07/00 → 06/04 D D4192T3

**84010 NEW 350984010000**

**PULEGGIA**

 Diametro Puleggia Ø56.21  
 Numero Denti/Gole Puleggia 19  
 Altezza Puleggia 33.5  
 Posizione Attacco 52.2  
 Diametro Girante Ø59.8  
 N° Alette Girante 8  
 Posizione Girante 48.2

**AUDI**
**A2**

 1.2 TDI 45 03/01 → 08/05 D ANY  
 1.4 TDI 55 02/00 → 08/05 D AMF, BHC  
 66 11/03 → 08/05 D ATL

**A3 II, Sportback, Cabriolet**

 1.9 TDI 77 05/03 → 05/10 D BKC, BLS, BXE  
 77 04/08 → 10/09 D BLS

**FORD**
**Galaxy I**

 1.9 TDI 96 02/03 → 05/06 D ASZ  
 110 05/05 → 05/06 D BTB

**84010 NEW 350984010000**

**SEAT**
**Alhambra I**

 1.9 TDI 96 11/02 → 11/08 D ASZ  
 1.9 Tdi 4x4 96 06/05 → 11/08 D ASZ

**Altea, Altea XL**

 1.9 TDI 66 08/09 → D BXF  
 77 04/04 → D BJB, BKC, BLS, BXE  
 77 10/06 → D BKC, BLS, BXE

**Arosa**

1.4 TDI 55 01/00 → 06/04 D AMF

**Cordoba III, Vario**

 1.4 TDI 51 05/05 → 11/09 D BNM  
 55 10/02 → 12/05 D AMF  
 59 06/05 → 11/09 D BMS, BNV  
 1.9 TDI 74 09/02 → 11/09 D ATD, AXR, BMT  
 96 10/02 → 11/09 D ASZ, BLT

**Ibiza IV**

 1.4 TDI 51 05/05 → 11/09 D BNM  
 55 05/02 → 12/05 D AMF  
 59 06/05 → 11/09 D BMS, BNV  
 1.9 TDI 74 02/02 → 11/09 D ATD, AXR, BMT  
 96 02/02 → 11/09 D ASZ, BLT

**Ibiza V**

 1.4 TDI 59 07/08 → 06/10 D BMS  
 1.9 TDI 66 07/08 → 06/10 D BXJ  
 77 03/08 → 06/10 D BLS

**Leon II**

 1.9 TDI 66 06/07 → 12/10 D BXF  
 77 07/05 → 12/10 D BKC, BLS, BXE  
 81 10/05 → 12/12 D ASV

**Toledo III**

1.9 TDI 77 10/04 → 05/09 D BJB, BKC, BLS, BXE

**SKODA**
**Fabia I, Station Wagon, Van**

 1.4 TDI 51 10/05 → 03/08 D BNM  
 55 04/03 → 03/08 D AMF  
 59 10/05 → 03/08 D BNV  
 1.9 TDI 74 01/00 → 03/08 D ATD, AXR  
 1.9 TDI RS 96 06/03 → 03/08 D ASZ, BLT

**84010**
**350984010000**

**SKODA**
**Fabia II, Station Wagon, Van**

1.4 TDI	51	02/07 → 03/10	D	BNM
	59	01/07 → 03/10	D	BMS, BNV
1.9 TDI	77	04/07 → 03/10	D	BLS, BSW

**Octavia II, Station Wagon**

1.9 TDI	77	06/04 → 12/10	D	BJB, BKC, BLS, BXE
1.9 TDI 4x4	77	11/04 → 12/10	D	BKC, BLS, BXE

**Roomster, Van**

1.4 TDI	51	07/06 → 03/10	D	BNM
	59	09/06 → 03/10	D	BMS, BNV
1.9 TDI	77	09/06 → 03/10	D	BLS, BSW

**Superb II, Station Wagon**

1.9 TDI	77	03/08 → 11/10	D	BLS, BXE
---------	----	---------------	---	----------

**VOLKSWAGEN**
**Caddy III**

1.9 TDI	55	09/05 → 08/10	D	BSU
	77	04/04 → 08/10	D	BJB, BLS
1.9 TDI 4motion	77	11/08 → 08/10	D	BLS
2.0 SDI	51	03/04 → 08/10	D	BDJ, BST

**Crafter 30-35, 30-50**

2.5 TDI	65	04/06 → 07/11	D	BJJ, CEBA
---------	----	---------------	---	-----------

**Fox I**

1.4 TDI	51	04/05 →	D	BNM
---------	----	---------	---	-----

**Golf V, Plus, Variant**

1.9 TDI	66	05/05 → 12/08	D	BRU, BXF, BXJ
	77	01/05 → 01/09	D	BKC, BLS, BXE
	77	06/07 → 07/09	D	BLS, BXE
1.9 TDI 4motion	77	08/04 → 11/08	D	BKC, BLS, BXE
	77	01/08 → 07/09	D	BLS
2.0 SDI	55	01/04 → 11/08	D	BDK

**Jetta III**

1.9 TDI	77	08/05 → 10/10	D	BKC, BLS, BXE
---------	----	---------------	---	---------------

**Lupo I**

1.2 TDI 3L	45	07/99 → 07/05	D	ANY, AYZ
1.4 TDI	55	01/99 → 07/05	D	AMF

**84010**
**350984010000**

**VOLKSWAGEN**
**Multivan V**

1.9 TDI	62	01/06 → 11/09	D	BRR
	63	04/03 → 11/09	D	AXC
	75	06/06 → 11/09	D	BRS
	77	04/03 → 11/09	D	AXB

**New Beetle, Cabrio**

1.9 TDI	74	02/01 → 09/10	D	ATD, BEW
	77	07/05 → 09/10	D	BSW

**Passat VI, Variant, CC**

1.9 TDI	77	03/05 → 11/08	D	BKC, BLS, BXE
---------	----	---------------	---	---------------

**Polo IV (6N2)**

1.4 TDI	55	10/99 → 09/01	D	AMF
	66	01/00 → 10/00	D	ATL

**Polo V (9N)**

1.4 TDI	51	04/05 → 11/09	D	BNM, BWB
	55	10/01 → 06/05	D	AMF, BAY
	55	07/03 →	D	BAY
	59	04/05 → 11/09	D	BMS, BNV
1.9 TDi	74	09/02 →	D	ATD
	74	10/01 → 11/09	D	ATD, AXR, BMT
	96	11/03 → 11/09	D	ASZ, BLT

**Sharan I**

1.9 TDI	96	11/02 → 03/10	D	ASZ
	110	06/05 → 03/10	D	BTB

**Touran I**

1.9 TDI	66	11/04 → 05/10	D	BRU, BXF, BXJ
	74	02/03 → 05/04	D	AVQ
	77	08/03 → 05/10	D	BKC, BLS, BXE

**Transporter V**

1.9 TDI	62	01/06 → 11/09	D	BRR
	63	04/03 → 11/09	D	AXC
	75	06/06 → 11/09	D	BRS
	77	04/03 → 11/09	D	AXB

**84011**
**NEW**
**350984011000**

**PULEGGIA**

Diametro Puleggia	Ø56
Numero Denti/Gole Puleggia	19
Altezza Puleggia	33.5
Posizione Attacco	52.2
Diametro Girante	Ø64
N° Alette Girante	8
Posizione Girante	47.5

**KW**

**AUDI**
**A3 I**

1.9 TDI	74	10/00 → 05/03	D	ATD, AXR
	96	08/00 → 05/03	D	ASZ
1.9 TDI quattro	96	08/00 → 05/03	D	ASZ

**A3 II, Sportback, Cabriolet**

2.0 TDI	100	05/03 → 08/12	D	AZV, CBAA, CFFA
	100	04/08 → 05/13	D	CBAA, CFFA
	103	06/05 → 06/08	D	BMM
	103	04/08 → 05/13	D	CBAB, CFFB
	120	06/06 → 06/08	D	BUY
2.0 TDI 16V	103	05/03 → 08/12	D	BKD, CBAB, CFFB, CLJA
2.0 TDI 16V quattro	103	08/04 → 08/12	D	BKD, CBAB, CFFB
2.0 TDI quattro	100	05/03 → 06/08	D	AZV
	103	01/06 → 06/08	D	BMM
	125	03/06 → 08/12	D	BMN, CBBB, CFGB

**A4 I, Avant**

1.9 TDI	85	03/00 → 11/00	D	AJM
1.9 TDI quattro	85	03/00 → 11/00	D	AJM, ATJ

**A4 II, Avant, Cabriolet**

1.9 TDI	74	05/01 → 12/04	D	AVB
	85	06/04 → 12/04	D	BKE
	96	11/00 → 12/04	D	AVF, AWX
1.9 TDI quattro	96	11/01 → 12/04	D	AVF
2.0 TDI	100	01/06 → 03/09	D	BRC
	103	01/06 → 03/09	D	BPW

**84011**
**NEW**
**350984011000**

**KW**

**AUDI**
**A4 III, Avant**

1.9 TDI	85	11/04 → 06/08	D	BKE, BRB
2.0 TDI	89	09/05 → 09/06	D	BVG
	93	11/05 → 11/06	D	BVF
	100	11/04 → 06/08	D	BNA, BRF
	103	11/04 → 06/08	D	BPW
	120	06/06 → 06/08	D	BVA
2.0 TDI 16V	103	11/04 → 06/08	D	BLB, BRE
2.0 TDI quattro	103	01/06 → 06/08	D	BPW
	120	06/06 → 06/08	D	BVA
	125	06/06 → 06/08	D	BRD

**A4 IV, Avant, Allroad**

2.0 TDI	88	06/08 → 12/15	D	CAGC, CJCC
	100	11/07 → 12/15	D	CAGB, CJCB, CSUB
	105	11/07 → 12/15	D	CAGA, CJCA, CMEA, CMFA
	120	08/08 → 12/15	D	CAHB, CGLD, CNHC
	125	01/08 → 03/12	D	CAHA
2.0 TDI quattro	100	09/09 →	D	CAGB, CJCB, CSUB
	105	11/08 → 12/15	D	CAGA, CJCA
	120	04/09 →	D	CAHB, CGLD, CNHC
	125	01/08 → 03/12	D	CAHA

**A5, Sportback, Cabriolet**

2.0 TDI	100	09/09 →	D	CAGB, CJCB
	105	09/09 →	D	CAGA, C10CA, CMEA, CMFA
	120	08/08 →	D	CAHB, CGLD
	125	08/08 →	D	CAHA
2.0 TDI quattro	125	08/08 →	D	CAHA

**A6 II, Avant**

1.9 TDI	85	07/00 → 01/05	D	AJM
	96	08/01 → 01/05	D	AVF, AWX

**A6 III, Avant, Allroad**

2.0 TDI	89	09/05 → 06/06	D	BVG
	100	07/04 → 03/11	D	BNA, BRF, CAGB
	103	07/04 → 10/08	D	BLB, BRE
	120	04/09 → 03/11	D	CAHB
	125	11/08 → 03/11	D	CAHA

**84011**
**NEW**
**350984011000**

**AUDI**
**Q5**

2.0 TDI quattro	100	08/09 →	D	CAGB, CJCB, CSUB	M: 20598
	105	08/09 →	D	CAGA, CJCA	M: 20597
	120	11/08 →	D	CAHB, CGLA, CGLD, CNHC	M: 20864
	125	11/08 →	D	CAHA, CGLB, CMGA	M: 20602

**TT II, Roadster**

2.0 TDI quattro	125	06/08 → 06/14	D	CBBB, CFBG	
-----------------	-----	---------------	---	------------	--

**CHRYSLER**
**Sebring III, Cabrio**

2.0 CRD	103	07/07 → 12/10	D	ECD	
---------	-----	---------------	---	-----	--

**DODGE**
**Avenger**

2.0 CRD	103	06/07 →	D	ECD	
---------	-----	---------	---	-----	--

**Caliber**

2.0 CRD	103	06/06 →	D	ECD, ECE	
---------	-----	---------	---	----------	--

**Journey**

2.0 CRD	103	06/08 →	D	ECE	
---------	-----	---------	---	-----	--

**FORD**
**Galaxy I**

1.9 TDI	66	03/95 → 05/06	D	1Z, AHU, ANU	
	85	04/00 → 05/06	D	AUY	

**JEEP**
**Compass**

2.0 CRD	103	08/06 →	D	ECD, ECE	
---------	-----	---------	---	----------	--

2.0 CRD 4x4	103	09/06 →	D	ECE	
-------------	-----	---------	---	-----	--

**Patriot**

2.0 CRD	103	02/07 →	D	ECD, ECE	
---------	-----	---------	---	----------	--

2.0 CRD 4x4	103	02/07 →	D	ECD, ECE	
-------------	-----	---------	---	----------	--

**MITSUBISHI**
**Grandis II**

2.0 DI-D	100	09/05 →	D	BSY	
	103	02/07 →	D	BWC	

**Lancer VIII, Station Wagon, Sportback**

2.0 DI-D	103	06/08 →	D	BKD, BWC	
----------	-----	---------	---	----------	--

**Outlander II, Van**

2.0 DI-D	103	02/07 → 11/12	D	BSY	
----------	-----	---------------	---	-----	--

**84011**
**NEW**
**350984011000**

**SEAT**
**Alhambra I**

1.9 TDI	66	04/96 → 03/10	D	1Z, AHU, ANU	
	85	06/00 → 03/10	D	AUY, BVK	
	110	05/05 → 05/07	D	BTB	
1.9 TDI 4motion	85	06/00 → 03/10	D	AUY, BVK	
2.0 TDI	103	11/05 → 03/10	D	BRT	

**Altea, Altea XL**

2.0 TDI	100	03/04 → 05/09	D	AZV	
	103	11/05 →	D	BMM	
	125	03/06 →	D	BMN, CEGA	
2.0 TDI 16V	103	03/04 →	D	BKD, CFHC	
2.0 TDI 4x4	103	06/07 →	D	BMM	
	125	06/07 →	D	BMN, CEGA, CFJA	

**Exeo, Exeo ST**

2.0 TDI	88	12/08 →	D	CAGC, CJCC	
	105	12/08 →	D	CAGA, CJCA	
	125	02/09 →	D	CAHA, CGLB	

**Ibiza IV**

1.9 TDI Cupra R	118	03/04 → 02/08	D	BPX, BUK	
-----------------	-----	---------------	---	----------	--

**Leon I**

1.9 TDI	74	10/05 → 06/06	D	AXR	
	96	05/03 → 06/06	D	ASZ	
	110	09/00 → 06/06	D	ARL	
1.9 TDI Syncro	110	05/02 → 06/06	D	ARL	

**Leon II**

2.0 TDI	100	07/05 → 05/10	D	AZV	
	103	10/05 → 10/10	D	BMM	
	125	05/06 → 12/12	D	BMN, CEGA, CFJA	
2.0 TDI 16V	103	07/05 → 12/12	D	BKD, CFHC, CLCB	

**Toledo II**

1.9 TDI	96	05/03 → 05/06	D	ASZ	
	110	10/00 → 07/04	D	ARL	

**Toledo III**

2.0 TDI	100	09/04 → 05/09	D	AZV	
	103	11/05 → 05/09	D	BMM	
	125	01/06 → 05/09	D	BMN, CEGA	
2.0 TDI 16V	103	04/04 → 05/09	D	BKD	

**84011** NEW **350984011000**

**SKODA**
**Octavia I, Station Wagon**

1.9 TDI	74	10/05 → 12/10	D	AXR
	96	09/02 → 09/04	D	ASZ
1.9 TDI 4x4	74	09/00 → 01/06	D	ATD

**Octavia II, Station Wagon**

2.0 TDI	100	02/04 → 05/10	D	AZV
	103	11/05 → 05/10	D	BMM
2.0 TDI 16V	100	02/04 → 05/10	D	AZV
	103	02/04 → 04/13	D	BKD, CFHC, CLCB
2.0 TDI 4x4	103	07/06 → 05/10	D	BMM
2.0 TDI RS	125	04/06 → 02/13	D	BMN, CEGA

**Roomster, Van**

1.9 TDI	74	03/06 → 05/06	D	AXR
---------	----	---------------	---	-----

**Superb I**

1.9 TDI	74	08/02 → 10/05	D	AVB
	77	10/05 → 05/07	D	BSV
	85	01/07 → 03/08	D	BPZ
	96	12/01 → 03/08	D	AVF, AWX
2.0 TDI	103	10/05 → 03/08	D	BSS

**Superb II, Station Wagon**

2.0 TDI	103	03/08 → 05/10	D	BMP
	125	07/08 → 05/15	D	CBBB, CFGB
2.0 TDI 16V	103	01/09 → 05/15	D	BKD, CFFB, CLJA
2.0 TDI 4x4	125	09/08 → 05/15	D	CBBB, CFGB

**Yeti**

2.0 TDI 4x4	103	05/09 →	D	CBDB, CFHC, CLCB
	125	11/09 →	D	CEGA, CFJA

**VOLKSWAGEN**
**Beetle II (Maggiolino)**

2.0 TDI	103	04/12 →	D	CFFB, CJAA
---------	-----	---------	---	------------

**Bora, Station Wagon**

1.9 TDI	74	09/00 → 05/05	D	ATD, AXR
	85	12/98 → 01/02	D	AJM, AUJ
	96	11/00 → 05/05	D	ASZ
	110	05/00 → 05/05	D	ARL
1.9 TDI 4motion	74	09/00 → 05/05	D	ATD
	85	02/99 → 06/01	D	AJM, AUJ
	96	11/00 → 05/05	D	ASZ
	110	05/00 → 05/05	D	ARL

**Caddy III**

2.0 TDI	103	09/07 → 08/10	D	BMM
---------	-----	---------------	---	-----

**84011** NEW **350984011000**

**VOLKSWAGEN**
**Eos**

2.0 TDI	103	06/06 → 05/08	D	BMM
2.0 TDI 16V	103	05/08 →	D	CBAB, CFFB

**Golf IV, Variant, Cabrio**

1.9 TDI	74	09/00 → 06/05	D	ATD, AXR
	85	12/98 → 06/01	D	AJM, AUJ
	96	11/00 → 06/05	D	ASZ
	110	05/00 → 06/05	D	ARL
1.9 TDI 4motion	74	09/00 → 06/05	D	ATD
	85	05/99 → 06/01	D	AJM
	85	09/99 → 06/01	D	AJM, AUJ
	96	11/00 → 06/05	D	ASZ
	110	02/00 → 06/05	D	ARL

**Golf V, Plus, Variant**

2.0 TDI	81	01/09 → 12/13	D	CBDC, CLCA
	96	05/05 → 05/07	D	BEE
	100	06/07 → 07/09	D	AZV
	100	10/03 → 11/08	D	AZV, CBDA
	100	05/05 → 12/13	D	AZV, CBDA, CFHB
2.0 TDI 16V	103	12/05 → 05/11	D	BMM
	125	11/05 → 11/08	D	BMN
	103	10/03 → 11/08	D	BKD
2.0 TDI 16V	103	06/07 → 07/09	D	BKD, CBDB
	103	01/05 → 12/13	D	BKD, CBDB, CFHC
2.0 TDI 16V 4motion	103	08/04 → 11/08	D	BKD
2.0 TDI 4motion	100	06/07 → 07/09	D	AZV
	103	08/04 → 11/08	D	BMM

**Golf VI, Variant, Cabrio**

2.0 TDI	81	10/08 → 11/12	D	CBDC, CLCA
	100	10/08 → 11/12	D	CBAA, CFFA
	100	07/09 → 07/13	D	CBDA, CFHB
	103	10/08 → 05/13	D	CBAB, CFFB, CJAA
	125	04/09 → 11/12	D	CBBB, CFGB
2.0 TDI 16V	103	07/09 → 07/13	D	CBDB, CFHC, CJAA, CLCB
2.0 TDI 4motion	103	05/09 → 11/12	D	CBAB, CFFB

84011 **NEW** 350984011000



**VOLKSWAGEN**

**Jetta III**

2.0 TDI	100	09/05 → 10/10	D	AZV, CBDA
	103	10/05 → 10/10	D	BMM
	125	10/06 → 10/10	D	BMN, CEGA
2.0 TDI 16V	103	08/05 → 10/10	D	BKD, CBDB, CBEA, CJAA

**New Beetle, Cabrio**

1.9 TDI	74	06/03 → 09/10	D	AXR
	77	07/05 → 09/10	D	BSW

**Passat IV, Variant**

1.9 TDI	74	02/00 → 11/00	D	AVB
	85	08/98 → 11/00	D	AJM, ATJ
1.9 TDI 4motion	85	08/99 → 11/00	D	ATJ

**Passat V, Variant**

1.9 TDI	74	11/00 → 05/05	D	AVB
	96	11/00 → 05/05	D	AVF, AWX
	96	11/00 → 05/05	D	AVF, AWX
1.9 TDI 4motion	96	11/00 → 05/05	D	AVF
	96	11/00 → 05/05	D	AVF
2.0 TDI	100	12/03 → 05/05	D	BGW, BHW

**Passat VI, Variant, CC**

2.0 BlueTDI	105	01/09 → 11/10	D	CBAC
2.0 TDI	81	11/08 → 07/10	D	CBDC
	88	11/05 → 05/07	D	BWV
	90	08/05 → 07/06	D	BVE
	100	03/05 → 11/10	D	BMA, CBAA
	100	06/08 → 05/11	D	CBAA, CFFA
	103	03/05 → 05/09	D	BMP
	103	06/08 → 01/12	D	CBAB, CFFB
	120	08/05 → 05/09	D	BUZ
	125	08/05 → 07/10	D	BMR, CBBB
	125	06/08 → 01/12	D	CBBB, CFGB, CLLA
2.0 TDI 16V	103	03/05 → 07/10	D	BKP, CBAB
2.0 TDI 16V 4motion	103	03/05 → 08/10	D	BKP, CBAB
2.0 TDI 4motion	103	03/05 → 05/09	D	BMP
	103	08/09 → 01/12	D	CBAB, CFFB
	125	05/09 → 07/10	D	CBBB
	125	11/09 → 01/12	D	CBBB, CFGB

**Scirocco III**

2.0 TDI	103	08/08 →	D	CBDB, CFHC
	125	05/09 →	D	CBBB, CFGB

84011 **NEW** 350984011000



**VOLKSWAGEN**

**Sharan I**

1.9 TDI	66	09/95 → 03/10	D	1Z, AHU, ANU
	85	04/00 → 03/10	D	AUY, BVK
1.9 TDI 4motion	85	04/00 → 03/10	D	AUY, BVK
2.0 TDI	100	11/05 → 03/10	D	BVH
	103	11/05 → 03/10	D	BRT

**Tiguan I**

2.0 TDI	103	03/08 →	D	CBAB, CFFB
	100	11/07 →	D	CBAA, CFFA
2.0 TDI 4motion	103	09/07 →	D	CBAB, CFFB, CLJA
	120	02/08 → 08/09	D	CBBA
	125	09/07 →	D	CBBB, CFGB

**Touran I**

2.0 TDI	100	02/03 → 05/10	D	AZV
	103	12/05 → 05/10	D	BMM
	125	12/05 → 05/10	D	BMN, CFJA
2.0 TDI 16V	103	08/03 → 05/10	D	BKD

84012 **NEW** 350984012000



**FLANGIA**

Numero Fori Flangia 4

Dimensione Fori Flangia M6x1

Posizione Attacco 48

Diametro Mozzo Ø22

Diametro Girante Ø53.5

N° Alette Girante 6

Posizione Girante 20



**SMART**

**Cabrio**

0.6	40	03/00 → 01/04	B	M160.920, M160E6ALB03
	45	01/01 → 01/04	B	M160.920, M160E6ALB05
	52	06/02 → 01/04	B	M160.920
0.7	45	01/03 → 01/04	B	M160.910
	55	01/03 → 01/04	B	M160.910
0.8 CDI	30	03/01 → 01/04	D	OM660.940, OM660DE8LA

**84012**
**NEW**
**350984012000**

**KW**

**SMART**
**City-Coupé**

0.6	33	07/98 → 01/04	B	M160.920, M160E6ALB04
	40	07/98 → 01/04	B	M160.920, M160E6ALB03
	45	01/01 → 01/04	B	M160.920, M160E6ALB05
	52	06/02 → 01/04	B	M160.920
0.7	37	01/03 → 01/04	B	M160.910
	45	01/03 → 01/04	B	M160.910
	55	01/03 → 01/04	B	M160.910
0.8 CDI	30	11/99 → 01/04	D	OM660.940, OM660DE8LA

**CrossBlade**

0.6	52	06/02 → 12/03	B	M160.920
-----	----	---------------	---	----------

**ForTwo I Coupé, Cabrio**

0.7	37	01/04 → 01/07	B	M160.910
	45	01/04 → 01/07	B	M160.910
	55	01/04 → 01/07	B	M160.910
0.8 CDI	30	01/04 → 01/07	D	OM660.940
	30	01/04 → 01/07	D	OM660.940, OM660DE8LA
	33	01/07 →	D	OM660.950
	40	08/09 →	D	OM660.951

**Roadster**

0.7	45	04/03 → 11/05	B	M160.921
	45	06/03 → 11/05	B	M160.922
	60	04/03 → 11/05	B	M160.921
	60	04/03 → 11/05	B	M160.922
0.7 Brabus	74	12/03 → 11/05	B	M160.923

**84013**
**NEW**
**350984013000**

**FLANGIA**

Posizione Attacco	69.80
Diametro Centraggio	Ø28
Diametro Girante	Ø59.4
N° Alette Girante	6
Posizione Girante	15.40

**KW**

**MINI**
**Mini I (R50,R52, R53)**

Cooper S	120	03/02 → 09/06	B	W11B16A
John Cooper Works	155	07/04 → 11/07	B	W11B16A
S Works	147	11/03 → 06/05	B	W11B16A
Works	155	11/03 → 09/06	B	W11B16A

**84014**
**NEW**
**350984014000**

**PULEGGIA**

Diametro Puleggia	Ø65
Altezza Puleggia	26.5
Posizione Attacco	44.9
Diametro Girante	Ø84.4
N° Alette Girante	7
Posizione Girante	35.6

**KW**

**CHEVROLET**
**Captiva**

2.0 D	93	10/06 →	D	Z20S
	110	09/07 →	D	Z20DMH, Z20S
2.0 D 4WD	93	10/06 →	D	Z20S
	110	10/06 →	D	Z20DMH, Z20S

**Cruze II, Hatchback, Station Wagon**

2.0 CDI	90	05/09 →	D	Z20S1
	92	05/09 →	D	Z20S1
	110	05/09 →	D	Z20DMH, Z20S1

**Epica**

2.0 D	110	01/07 →	D	Z20S
-------	-----	---------	---	------

**Lacetti**

2.0 D	89	01/07 →	D	Z20DM
-------	----	---------	---	-------

84014 **NEW** 350984014000



## CHEVROLET

### Nubira, Station Wagon

2.0 D	89	01/07 →	D	Z20DM, Z20S	
	89	01/05 →	D	Z20S	

## DAEWOO

### Tosca

2.0 TDCi	110	02/06 →	D	Z20DMH	
----------	-----	---------	---	--------	--

## OPEL

### Antara

2.0 CDTI	93	03/07 →	D	Z20DM, Z20S	
	110	05/06 →	D	Z20DMH, Z20S	
2.0 CDTI 4x4	110	05/06 →	D	Z20DMH, Z20S	

## VAUXHALL

### ANTARA

2.0 CDTI	110	08/06 → 04/15	D	Z20DMH	
----------	-----	---------------	---	--------	--

84015 **NEW** 350984015000



### FLANGIA

Numero Fori Flangia	4
Dimensione Fori Flangia	M6×1
Posizione Attacco	52
Diametro Centraggio	Ø24
Diametro Girante	Ø57
N° Alette Girante	6
Posizione Girante	28.2



## HYUNDAI

### Elantra II

1.6 CVVT	90	06/06 → 06/11	B	G4FC	
2.0 CVVT	105	06/06 → 06/11	B	G4GC	→ 10-2006
1.6	97	06/11 →	B	G4FG	

### i10 I

1.2	57	11/08 →	B	G4LA	
-----	----	---------	---	------	--

### i20 I

1.4	74	09/08 →	B	G4FA	
1.6	93	09/08 →	B	G4FC	

### i30 I, Station Wagon

1.4	77	10/07 → 11/11	B	G4FA	
	80	10/07 → 11/11	B	G4FA	

84015 **NEW** 350984015000



## HYUNDAI

### i30 I, Station Wagon

1.6	85	10/07 → 11/11	B	G4FC	
	90	10/07 → 11/11	B	G4FC	
	93	02/08 → 11/11	B	G4FC	

### i30 II, Station Wagon, Coupé

1.4	74	01/15 →	B	G4LC	→ 12-2014
	73	12/11 →	B	G4FA	→ 12-2014
	73	06/12 →	B	G4FA	
1.6	88	01/12 →	B	G4FC	
	88	06/12 →	B	G4FG	
	95	06/12 →	B	G4FG	
1.6 GDI	95	12/11 →	B	G4FG	
	99	12/11 →	B	G4FD	
1.6 T-GDI	137	01/15 →	B	G4FJ	

### i40

1.6 GDI	99	03/12 →	B	G4FD	
---------	----	---------	---	------	--

### ix 20

1.4	66	11/10 →	B	G4FA	
1.6	92	11/10 →	B	G4FC	

### ix 35

1.6	99	11/10 →	B	G4FD	
-----	----	---------	---	------	--

### Tucson III

1.6 GDi	97	06/15 →	B	G4FD	
1.6 T-GDI	130	06/15 →	B	G4FJ	
1.6 T-GDI Trazione integrale	130	06/15 →	B	G4FJ	

### Velostar

1.6 GDI	103	03/11 →	B	G4FD	
1.6 T-GDI	137	10/12 →	B	G4FJ	

## KIA

### Carens III

1.6 CVVT	93	10/10 →	B	G4FC	
	97	08/09 →	B	G4FC	

### Carens IV

1.6 GDi	99	03/13 →	B	G4FD	
---------	----	---------	---	------	--

### Cee'd I, Station Wagon

1.4	77	12/06 → 12/12	B	G4FA	
	80	12/06 → 12/12	B	G4FA	
1.4 CVVT	66	06/10 → 12/12	B	G4FA-L	
1.6	85	09/07 → 12/12	B	G4FC	
	90	12/06 → 12/12	B	G4FC	
	93	02/08 → 12/12	B	G4FC	
1.6 CVVT	92	10/10 → 12/12	B	G4FC	



**84015**
**NEW**
**350984015000**

**KW**

**KIA**
**Cee'd II, Station Wagon**

1.4 CVT	66	05/12 →	B	G4FA-L
	73	05/12 →	B	G4FA
1.6 CVT	92	05/12 →	B	G4FC
1.6 GDI	99	05/12 →	B	G4FD
1.6 GT	150	06/13 →	B	G4FJ

**Cerato I**

1.6	90	05/06 →	B	G4FC
-----	----	---------	---	------

**Cerato II**

1.6	93	01/10 →	B	G4FC
1.6 CVT	91	02/09 →	B	G4FC
1.6 MPi	96	06/13 →	B	G4FC

**Pro Cee'd I**

1.4	77	02/08 → 09/12	B	G4FA
	80	02/08 → 09/12	B	G4FA
1.4 CVT	66	06/10 → 09/12	B	G4FA-L
1.6	90	02/08 → 09/12	B	G4FC
	93	02/08 → 09/12	B	G4FC
1.6 CVT	92	10/10 → 02/13	B	G4FC

**Pro Cee'd II**

1.4 CVT	73	03/13 →	B	G4FA
1.6 GDI	99	03/13 →	B	G4FD
1.6 GT	150	06/13 →	B	G4FJ

**Rio III**

1.4 CVT	79	09/11 →	B	G4FA
	80	09/11 →	B	G4FA
1.6 CVT	90	06/12 →	B	G4FC

**Soul I**

1.6	91	09/09 → 12/10	B	G4FG
1.6 CVT	77	02/09 →	B	G4FC
	93	02/09 →	B	G4FC
	95	03/12 →	B	G4FC
1.6 GDI	103	06/11 →	B	G4FD

**Soul II**

1.6 GDI	97	02/14 →	B	G4FD
---------	----	---------	---	------

**Sportage III**

1.6 GDI	97	09/15 →	B	G4FD
	99	02/11 →	B	G4FD
	130	09/15 →	B	G4FJ
1.6 GDI 4WD	130	09/15 →	B	G4FJ

**Venga**

1.4 CVT	66	02/10 →	B	G4FA-L
1.6 CVT	92	02/10 →	B	G4FC

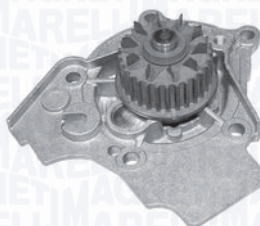
**84016**
**NEW**
**350984016000**

**PULEGGIA**

Diametro Puleggia	Ø45
Numero Denti/Gole Puleggia	29
Altezza Puleggia	18.1
Posizione Attacco	32.8
Diametro Girante	Ø61
N° Alette Girante	6
Posizione Girante	18.5

**KW**

**AUDI**
**A3 II, Sportback, Cabriolet**

1.8 TFSI	118	11/06 → 08/12	B	BYT, BZB, CDAA
	118	04/08 → 05/13	B	BZB, CDAA
1.8 TFSI quattro	118	07/08 → 08/12	B	CDAA
2.0 TFSI	147	04/08 → 05/13	B	CAWB, CCZA

**A4 IV, Avant, Allroad**

1.8 TFSI	88	01/08 → 12/15	B	CABA, CDHA
	88	04/08 → 12/15	B	CDHA
	118	11/07 → 03/12	B	CABB, CCUA, CDHB
1.8 TFSI quattro	118	09/08 → 03/12	B	CDHB
2.0 TFSI	132	06/08 → 12/15	B	CAEA, CDNB, CFKA
	155	06/08 → 05/13	B	CAEB, CDNC
2.0 TFSI flexible fuel	132	11/09 → 12/15		CFKA
2.0 TFSI flexible fuel quattro	132	11/09 → 12/15		CFKA
2.0 TFSI quattro	155	06/08 → 12/15	B	CAEB, CDNC
	155	06/08 → 12/15	B	CAEB, CDNC, CPMA
	155	04/09 →	B	CDNC, CPMA
	162	05/13 → 12/15	B	CAED, CPMB
	162	05/13 →	B	CPMB

**A5, Sportback, Cabriolet**

1.8 TFSI	118	05/09 →	B	CDHB
	125	10/07 →	B	CABD, CJEB
2.0 TFSI	132	03/09 →	B	CAEA, CDNB
	132	11/08 →	B	CDNB
	155	03/09 →	B	CAEB, CDNC → 07-2011
	155	06/08 →	B	CDNC → 07-2011
	162	05/13 →	B	CAED
	165	05/13 →	B	CNCD

**84016**
**NEW**
**350984016000**

**KW**

**AUDI**
**A5, Sportback, Cabriolet**

2.0 TFSI quattro	155	06/08 →	B	CAEB, CDNC	→ 07-2011
	155	09/09 →	B	CDNC	→ 07-2011
	162	03/12 →	B	CAED, CPMB	
	165	05/13 →	B	CNCD	

**A6 IV, Avant, Allroad**

2.0 TFSI	132	05/11 →	B	CDNB	
	155	03/11 → 05/13	B	CAEB	
2.0 TFSI hybrid	155	11/11 →		CHJA	

**A8 III**

2.0 TFSI hybrid	155	02/12 →		CHJA	
-----------------	-----	---------	--	------	--

**Q3**

2.0 TFSI quattro	125	06/11 →	B	CCZC	
	155	06/11 →	B	CPSA	
	162	11/14 →	B		

**Q5**

2.0 TFSI hybrid quattro	155	06/11 →		CHJA	
2.0 TFSI quattro	132	08/09 →	B	CDNB, CNCB	
	155	11/08 →	B	CAEB, CDNC, CPMA	
	162	05/13 →	B	CPMB	

**TT II, Roadster**

1.8 TFSI	118	06/08 → 06/14	B	CDA	
2.0 TFSI	155	05/10 → 06/14	B	CESA	
2.0 TFSI quattro	155	05/10 → 06/14	B	CESA, CETA	

**SEAT**
**Alhambra II**

2.0 TSI	147	11/10 →	B	CCZA	
---------	-----	---------	---	------	--

**Altea, Altea XL**

1.8 TFSI	118	01/07 →	B	BYT, BZB, CDAA	→ 05-2007, → T:5P7084000
	118	01/07 →	B	BYT, BZB, CDAA	06-2007 →, → 05-2007, T → :5P7084001, → T:5P7084000
2.0 TFSI 4x4	155	05/09 →	B	CCZB	

**84016**
**NEW**
**350984016000**

**KW**

**SEAT**
**Exeo, Exeo ST**

1.8 TSI	88	09/10 →	B	CDHA	
	118	05/10 →	B	CDHB	
2.0 TFSI	155	05/10 →	B	CDND	

**Leon II**

1.8 TSI	118	06/07 → 12/12	B	BZB, CDAA	
2.0 Cupra R	195	09/09 → 12/12	B	CDLA	
2.0 TFSI	155	06/09 → 12/12	B	CCZB	

**Toledo III**

1.8 TFSI	118	01/07 → 05/09	B	BYT, BZB, CDAA	
----------	-----	---------------	---	----------------	--

**SKODA**
**Octavia II, Station Wagon**

1.8 TSI	112	03/09 → 06/13	B	CDAB	
	118	06/07 → 04/13	B	BZB, CDAA	
1.8 TSI 4x4	112	03/09 → 02/13	B	CDAB	
	118	11/08 → 02/13	B	CDA	

**Superb II, Station Wagon**

1.8 TSI	112	03/09 → 05/15	B	CDAB	
	118	03/08 → 05/15	B	BZB, CDAA	
	118	10/09 → 05/15	B	CDA	
1.8 TSI 4x4	112	03/09 → 05/15	B	CDAB	
	118	11/08 → 05/15	B	CDA	
2.0 TSI	147	05/10 → 05/15	B	CCZA	

**Yeti**

1.8 TSI 4x4	112	11/09 →	B	CDAB	
	118	05/09 →	B	CDA	

**VOLKSWAGEN**
**Amarok**

2.0 TSI	118	12/10 →	B	CFPA	
---------	-----	---------	---	------	--

**Beetle II (Maggiolino)**

2.0 TSI	147	04/11 →	B	CBFA, CCTA, CCZA	
---------	-----	---------	---	------------------	--

**CC**

1.8 TSI	112	11/11 →	B	CDAB	
	118	11/11 →	B	CDA	
2.0 TSI	155	11/11 →	B	CCZB	

**Eos**

2.0 TSI	155	11/09 →	B	CCZB	
---------	-----	---------	---	------	--

**Golf VI, Variant, Cabrio**

1.8 TSI	118	06/09 → 01/11	B	CDA	
2.0 GTi	155	04/09 → 11/12	B	CCZB	
2.0 TSI	147	07/09 → 07/13	B	CCZA	

**84016** **NEW** 350984016000

**VOLKSWAGEN**
**Jetta IV**

2.0 TSI	147	12/10 →	B	CBFA, CCTA, CCZA
---------	-----	---------	---	------------------

**Multivan V**

2.0 TSI	110	07/12 →	B	CJKB
	150	05/11 →	B	CJKA

2.0 TSI 4motion	150	07/11 →	B	CJKA
-----------------	-----	---------	---	------

**Passat VI, Variant, CC**

1.8 TSI	112	11/09 → 07/10	B	CDAB, CGYA
	118	05/07 → 07/10	B	BZB, CDAA

2.0 FSI	125	08/07 → 07/10	B	CCTB
	155	11/10 → 01/12	B	CCZB

**Passat VII, Variant, CC, AllTrack**

1.8 TSI	112	02/11 → 12/14	B	CDAB
	118	08/10 → 12/14	B	CDAA

2.0 TSI	155	11/10 → 12/14	B	CCZB
---------	-----	---------------	---	------

2.0 TSI 4motion	155	01/12 → 12/14	B	CCZB
-----------------	-----	---------------	---	------

**Scirocco III**

2.0 TSI	147	05/08 → 11/09	B	CAWB
	155	11/09 →	B	CCZB

**Sharan II**

2.0 TSI	147	12/10 →	B	CCZA
---------	-----	---------	---	------

**Tiguan I**

2.0 TFSI 4motion	125	09/07 →	B	CAWA, CCZC
	147	09/07 →	B	CAWB, CCTA, CCZA

2.0 TSI 4motion	132	05/11 →	B	CCZD
	155	05/11 →	B	CCZB

**Transporter V**

2.0 TSI	110	07/12 →	B	CJKB
	150	05/11 →	B	CJKA

2.0 TSI 4motion	150	07/11 →	B	CJKA
-----------------	-----	---------	---	------

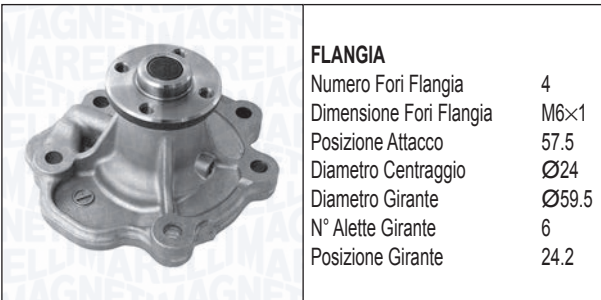
**84017** **NEW** 350984017000

**NISSAN**
**Pixo**

1.0	50	06/09 →	B	K10B
-----	----	---------	---	------

**OPEL**
**Agila B**

1.0	48	04/08 →	B	K10B
	50	07/11 →	B	K10B

1.0 LPG	48	01/10 →		K10B
---------	----	---------	--	------

1.2	63	04/08 →	B	K12B
	69	11/10 →	B	K12B

1.2 LPG	63	04/08 →		K12B
---------	----	---------	--	------

**SUZUKI**
**Alto V**

1.0	50	01/09 →	B	K10B
-----	----	---------	---	------

**Celerio**

1.0	50	03/14 →	B	K10B
-----	----	---------	---	------

**Splash**

1.0	48	01/08 →	B	K10B
	50	06/11 →	B	K10B

1.2	63	01/08 →	B	K12B
-----	----	---------	---	------

1.2 VVT	66	06/11 →	B	K12B
	69	09/10 →	B	K12B

**Swift IV**

1.2	66	10/10 →	B	K12B
	69	10/10 →	B	K12B

1.2 4x4	66	10/10 →	B	K12B
	69	10/10 →	B	K12B

84018

NEW

350984018000

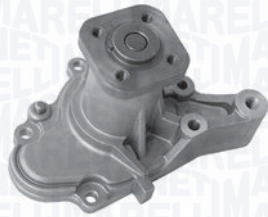

<b>FLANGIA</b>	
Numero Fori Flangia	4
Dimensione Fori Flangia	M6x1
Posizione Attacco	80.5
Diametro Centraggio	Ø24
Diametro Girante	Ø53.5
N° Alette Girante	7
Posizione Girante	6



**HYUNDAI**

**Atos, Atos Prime**

1.1	43	06/03 →	B	G4HD	
	46	03/04 →	B	G4HG	

**Getz**

1.1	46	09/02 → 09/05	B	G4HD	
-----	----	---------------	---	------	--

**i10 I**

1.1	48	12/07 →	B	G4HG	
	49	01/08 →	B	G4HG	
	51	04/11 →	B	G4HG	

**KIA**

**Picanto I**

1.0	45	04/04 →	B	G4HE	
	46	11/09 →	B	G4HE	
1.1	48	04/04 →	B	G4HG	

84019

NEW

350984019000



<b>FLANGIA</b>	
Numero Fori Flangia	3
Numero Fori Flangia (Serie 2)	3
Dimensione Fori Flangia	M8x1.25
Dimensione Fori Flangia (Serie 2)	7x12.5
Posizione Attacco	80.3
Diametro Centraggio	Ø28
Diametro Girante	Ø67
N° Alette Girante	7
Posizione Girante	33.5



**CITROËN**

**C 5 III, Break**

3.0 HDi 240	177	04/09 →	D	DT20C	
-------------	-----	---------	---	-------	--

**C 6**

3.0 HDi	177	04/09 →	D	DT20C	
---------	-----	---------	---	-------	--

**PEUGEOT**

**407, Station Wagon, Coupé**

3.0 HDi	177	06/09 →	D	DT20C	
---------	-----	---------	---	-------	--

84020

NEW

350984020000



<b>PULEGGIA</b>	
Diametro Puleggia	Ø53
Numero Denti/Gole Puleggia	18
Altezza Puleggia	33.5
Posizione Attacco	41.4
Diametro Girante	Ø74.5
N° Alette Girante	24
Posizione Girante	25.5



**CITROËN**

**C 4 I, Coupé, Picasso, Grand Picasso**

2.0 HDi 150	110	07/09 →	D	RHE (DW10CTED4)	
-------------	-----	---------	---	-----------------	--

2.0 HDi 165	120	09/10 →	D	RHH (DW10CTED4)	
-------------	-----	---------	---	-----------------	--

**C 4 II, Picasso, Grand Picasso**

2.0 BlueHDi 150	110	11/09 →	D	RHE (DW10CTED4)	
-----------------	-----	---------	---	-----------------	--

**C 5 III, Break**

2.0 HDi 150/BlueHDi 150	110	04/09 →	D	AHR (DW10FD), RHE (DW10CTED4)	M: DW10CTED4
-------------------------	-----	---------	---	-------------------------------	--------------

2.0 HDi 165	120	04/09 →	D	RHH (DW10CTED4)	
-------------	-----	---------	---	-----------------	--

**DS 4**

2.0 HDi 135	100	09/11 → 07/15	D	RHE (DW10CTED4)	
-------------	-----	---------------	---	-----------------	--

2.0 HDi 165	120	04/11 → 07/15	D	RHH (DW10CTED4)	
-------------	-----	---------------	---	-----------------	--

**DS 5**

2.0 HDi 135	100	11/11 → 07/15	D	RHD (DW10CB)	
-------------	-----	---------------	---	--------------	--

2.0 HDi 165	120	11/11 → 07/15	D	RHH (DW10CTED4)	
-------------	-----	---------------	---	-----------------	--

2.0 HDi 165 Hybrid 4x4	120	12/11 → 07/15		RHC (DW10CTED4)	
------------------------	-----	---------------	--	-----------------	--

**Jumpy III**

2.0 HDi 125	94	07/11 →	D	AHZ (DW10CD)	
-------------	----	---------	---	--------------	--

2.0 HDi 165	120	07/10 →	D	RHH (DW10CTED4)	
-------------	-----	---------	---	-----------------	--

2.0 HDi 95	72	07/11 →	D	AHY (DW10CE)	
------------	----	---------	---	--------------	--

**84020** **NEW** 350984020000

**DS**
**DS5**

2.0 HDi 165 Hybrid4 4x4	120	04/15 →			
-------------------------	-----	---------	--	--	--

**FIAT**
**Scudo II**

2.0 D Multijet	94	04/11 →	D	RH02	
	120	07/10 →	D	RH02, RHH	
2.0 D Multijet 4x4	94	04/11 →	D	RH02	

**FORD**
**C-Max II, Van**

2.0 TDCi	85	02/11 →	D	TYDA	
	100	02/11 →	D	UKDB	
	103	02/11 →	D	UFDB	
	120	12/10 →	D	TXDB	

**Focus III, Station Wagon, Van**

2.0 TDCi	85	07/10 →	D	TYDA	
	100	07/10 →	D	UKDB	
	103	07/10 →	D	UFDB	
	120	07/10 →	D	TXDB	

**Galaxy II**

2.0 TDCi	120	03/10 → 06/15	D	TXWA	
----------	-----	---------------	---	------	--

**Grand C-Max**

2.0 TDCi	85	02/11 →	D	TYDA	
	100	02/11 →	D	UKDB	
	103	02/11 →	D	UFDB	
	120	12/10 →	D	TXDB	

**Kuga I**

2.0 TDCi	103	03/10 → 11/12	D	UFDA	
2.0 TDCi 4x4	103	03/10 → 11/12	D	UFDA	
	120	03/10 → 11/12	D	TXDA	

**Kuga II, Van**

2.0 TDCi	100	03/13 →	D	UKMA	
	103	03/13 →	D	UFMA	
	88	09/14 →	D	XRMA, XRMB	
		110	09/14 →	D	T7MA, T7MB
2.0 TDCi 4x4	100	03/13 →	D	UKMA	
	103	03/13 →	D	UFMA	
	110	09/14 →	D	T7MA, T7MB	
	120	03/13 →	D	TXDA, TXMA	

**Mondeo IV, Station Wagon**

2.0 TDCi	120	03/10 → 09/14	D	TXBA, TXBB	
----------	-----	---------------	---	------------	--

**S-Max**

2.0 TDCi	120	03/10 →	D	TXWA	
----------	-----	---------	---	------	--

**84020** **NEW** 350984020000

**PEUGEOT**
**308 I, Station Wagon, CC**

2.0 HDi	110	10/11 →	D	RHE (DW10CTED4)	
	120	04/12 →	D	RHH (DW10CTED4)	

**508, Station Wagon**

2.0 HDi	103	11/10 →	D	RHF (DW10BTED4)	
	120	11/10 →	D	RHH (DW10CTED4)	
2.0 HDi Hybrid4 AWC	120	11/10 →		RHC (DW10CTED4)	
	147	11/10 →			
2.0 HDiRXH Hybrid4	120	11/10 →		RHC (DW10CTED4)	
	147	12/11 →		RHC (DW10CTED4)	

**807**

2.0 HDi	120	06/09 →	D	RHH (DW10CTED4)	
---------	-----	---------	---	-----------------	--

**3008**

2.0 HDi	100	09/11 →	D		
	120	06/09 →	D	RHH (DW10CTED4)	
2.0 HDi 150 / BlueHDi 150	110	06/09 →	D	AHX (DW10FD), RHE (DW10CTED4)	
2.0 HDi Hybrid4	120	02/11 →		RHC (DW10CTED4)	

**5008**

2.0 HDi	120	09/09 →	D	RHH (DW10CTED4)	
2.0 HDi 136 / BlueHDi 136	100	02/12 →	D	AHV (DW10FD), RHD (DW10CTED4)	
2.0 HDi 150 / BlueHDi 150	110	06/09 →	D	AHX (DW10FD), RHE (DW10CTED4)	

## 84020 NEW 350984020000



### PEUGEOT

#### Expert II, Tepee

2.0 HDi 100	72	03/11 →	D	AHY (DW10CE)
2.0 HDi 120 4x4	88	01/07 →	D	RHK (DW10UTED4)
2.0 HDi 130	94	03/11 →	D	AHZ (DW10CD)
2.0 HDi 165	120	09/09 →	D	RHH (DW10CTED4)

### RCZ

2.0 HDi	120	03/10 →	D	RHH (DW10CTED4)
---------	-----	---------	---	--------------------

## 84021 NEW 350984021000

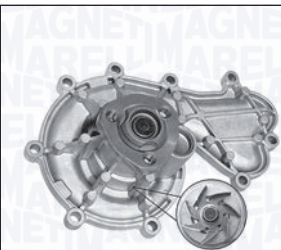

### FLANGIA

Numero Fori Flangia	3
Dimensione Fori Flangia	M8x1.25
Posizione Attacco	56
Diametro Centraggio	Ø30
Diametro Girante	Ø65.5
N° Alette Girante	7
Posizione Girante	17.2



### AUDI

#### A4 IV, Avant, Allroad

3.0 TDI	150	11/11 → 12/15	D	CLAB
3.0 TDI quattro	180	11/11 → 12/15	D	CDUC, CKVB, CKVC

#### A5, Sportback, Cabriolet

3.0 TDI	150	10/11 →	D	CLAB
3.0 TDI quattro	180	10/11 →	D	CDUC, CKVB, CKVC
	180	10/11 →	D	CDUC, CKVC

#### A6 IV, Avant, Allroad

3.0 TDI	150	11/10 →	D	CLAB
3.0 TDI quattro	150	03/11 →	D	CLAA

### A7

3.0 TDI	150	11/10 →	D	CLAB
	150	12/10 →	D	CLAA
3.0 TDI quattro	180	10/10 →	D	CDUC, CDUD, CKVB, CKVC M: CDUD, M: CDUC

## 84021 NEW 350984021000



### AUDI

#### A8 III

3.0 TDI	150	09/11 →	D	CLAB
	155	08/10 →	D	CDTB, CTBB
3.0 TDI quattro	184	07/10 →	D	CDTA, CDTC, CMHA

### Q5

SQ5 TDI quattro	240	04/15 →	D	CVUB
-----------------	-----	---------	---	------

### Q7 I

3.0 TDI	150	05/10 → 08/15	D	CJGC, CJMA
	180	05/11 → 08/15	D	CJGD, CLZB, CRCA

### VOLKSWAGEN

#### Touareg II

3.0 V6 TDI	150	01/10 →	D	CASD, CJMA, CVWA
	180	05/11 →	D	CJGD, CRCA
	193	09/14 →	D	CVVA

## 84022 NEW 350984022000



### PULEGGIA

Diametro Puleggia	Ø94
Numero Denti/Gole Puleggia	6
Altezza Puleggia	23
Posizione Attacco	52.3
Diametro Girante	Ø62
N° Alette Girante	6
Posizione Girante	5.4



### BMW

#### 3 V (E90), Touring (E91), Cabrio (E93), Coupé (E92)

325 d	150	04/10 → 12/13	D	M57N2306D3, N57D30A
	150	01/10 → 12/11	D	N57D30A
330 d	180	01/09 → 12/11	D	M57N2306D3, N57D30A
330 d xDrive	180	01/09 → 12/11	D	N57D30A
330 xd	180	01/09 → 12/13	D	M57N2306D3, N57D30A

**84023**
**NEW**
**350984023000**

**PULEGGIA**

Diametro Puleggia	Ø94
Numero Denti/Gole Puleggia	7
Altezza Puleggia	26.5
Posizione Attacco	53.5
Diametro Girante	Ø62
N° Alette Girante	6
Posizione Girante	5.4

**KW**

**BMW**
**5 VI (F10), Touring (F11), GT (F07)**

525 d	150	02/10 →	D	N57D30A
530 d	155	07/10 →	D	N57D30A
	180	12/09 →	D	N57D30A
530 d xDrive	180	09/10 →	D	N57D30A
	190	10/09 →	D	N57D30A
535 d	220	08/10 →	D	N57D30B
535 d xDrive	220	09/10 →	D	N57D30B

**7 V (F01, F02, F03, F04)**

730 d	180	10/08 → 12/15	D	N57D30A
740 d	225	09/09 → 12/15	D	N57D30B
740 d xDrive	225	09/09 → 12/15	D	N57D30B

**X5 II (E70)**

xDrive 30 d	155	09/08 → 06/13	D	N57D30A
	180	09/10 → 06/13	D	N57D30A
xDrive 40 d	225	09/10 → 06/13	D	N57D30B

**X6 I (E71, E72)**

xDrive 30 d	155	09/10 → 06/14	D	N57D30A
	180	09/10 → 06/14	D	M57D30 (306D3), M57N2306D3, N57D30A
xDrive 40 d	225	10/10 → 06/14	D	N57D30B

**84024**
**NEW**
**350984024000**

**PULEGGIA**

Diametro Puleggia	Ø56.2
Altezza Puleggia	30.3
Posizione Attacco	56.1
Diametro Girante	Ø60
N° Alette Girante	6
Posizione Girante	5.3

**KW**

**RENAULT**
**Clio III, Grandtour**

1.2 16V	76	09/10 →	B	D4F786
1.2 Ethanol	55	07/08 →		

**Clio IV, Grandtour**

1.2 16V	54	11/12 →	B	D4F728, D4F740
	54	01/13 →	B	D4F740

**Wind**

1.2	74	07/10 →	B	D4F782
-----	----	---------	---	--------

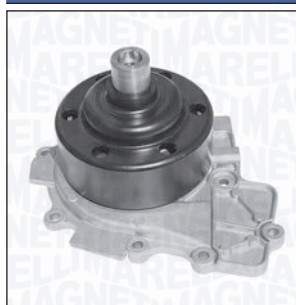
**84025**
**NEW**
**350984025000**

**PULEGGIA**

Diametro Puleggia	Ø105
Altezza Puleggia	37.5
Posizione Attacco	54.5
Diametro Girante	Ø81.8
N° Alette Girante	9
Posizione Girante	3.75

**KW**

**MERCEDES-BENZ**
**Sprinter III (906)**

210 CDI	70	03/09 →	D	OM651.955
213 CDI	95	06/06 →	D	OM651.955, OM651.956
	95	03/09 →	D	OM651.956
216 CDI	120	06/06 →	D	OM651.955, OM651.957
	120	03/09 →	D	OM651.957
310 CDI	70	03/09 →	D	OM651.955
	70	03/09 →	D	OM651.955, OM651.956
313 CDI	95	08/11 →	D	OM651.955, OM651.956
313 CDI 4x4	95	08/11 →	D	OM651.955, OM651.956

84025

NEW

350984025000



**MERCEDES-BENZ**

**Sprinter III (906)**

316 CDI	120	08/11 →	D	OM651.955, OM651.957
	120	03/09 →	D	OM651.957
316 CDI 4x4	120	08/11 →	D	OM651.955, OM651.957
413 CDI	95	06/06 →	D	OM646.986
416 CDI	120	03/09 →	D	OM651.957
510 CDI	70	03/09 →	D	OM651.955
513 CDI	95	06/06 →	D	OM651.955, OM651.956
	95	06/06 →	D	OM651.956
	95	06/06 →	D	OM646.986
513 CDI 4x4	95	05/11 →	D	OM651.955, OM651.956
	95	06/06 →	D	OM651.956
516 CDI	120	03/09 →	D	OM651.955, OM651.957
516 CDI 4x4	120	06/06 →	D	OM651.955, OM651.957

84026

NEW

350984026000



**PULEGGIA**

Diametro Puleggia	Ø87.5
Altezza Puleggia	20
Posizione Attacco	56.6
Diametro Girante	Ø62.2
N° Alette Girante	7
Posizione Girante	17.3



**MINI**

**Mini Clubvan**

Cooper D	82	12/12 →	D	N47C16A
	82	12/12 →	D	N47C20A

**Mini Countryman (R60)**

Cooper D	82	06/10 →	D	N47C16A
	82	02/11 →	D	N47C20A
Cooper D ALL4	82	06/10 →	D	N47C16A
	82	02/11 →	D	N47C20A
Cooper SD	105	02/11 →	D	N47C20A
Cooper SD ALL4	100	02/11 →	D	N47C20A
	105	02/11 →	D	N47C20A
One D	66	06/10 →	D	N47C16A

84026

NEW

350984026000



**MINI**

**Mini II (R55, R56, R57, R58, R59)**

Cooper D	82	06/10 → 11/13	D	N47C16A
	82	02/11 → 11/13	D	N47C20A
Cooper SD	100	02/11 → 11/13	D	N47C20A
	105	02/11 → 11/13	D	N47C20A
One D	66	07/10 → 11/13	D	N47C16A

**Mini Paceman (R61)**

Cooper D	82	09/12 →	D	N47C16A
	82	09/12 →	D	N47C20A
Cooper D ALL4	82	09/12 →	D	N47C16A
	82	09/12 →	D	N47C20A
Cooper SD	105	10/12 →	D	N47C20A
Cooper SD ALL4	105	10/12 →	D	N47C20A

**TOYOTA**

**Auris II, Touring Sports, Van**

1.6 D4-D	82	04/15 →	D	1WW
----------	----	---------	---	-----

**RAV 4 IV**

2.0 D-4D	105	10/15 →	D	2WW
----------	-----	---------	---	-----

**Verso**

1.6 D4-D	82	11/13 →	D	1WW
----------	----	---------	---	-----

84027

NEW

350984027000



**FLANGIA**

Numero Fori Flangia	3
Dimensione Fori Flangia	M8x1.25
Posizione Attacco	55.2
Diametro Centraggio	Ø30
Diametro Girante	Ø52.5
N° Alette Girante	6
Posizione Girante	13.6



**CHEVROLET**

**Aveo II**

1.2	51	03/11 →	B	A12XEL
	63	03/11 →	B	A12XER
1.2 LPG	63	11/12 →		A12XER
1.4	74	03/11 →	B	A14XER
1.4 Turbo	103	08/13 →	B	LUJ, LUV



**84027** NEW **350984027000**

**CHEVROLET**
**Cruze II, Hatchback, Station Wagon**

1.4	103	06/12 →	B	LUJ
	103	09/10 →	B	A14NET, LUJ, LUV
	74	07/13 →	B	A14XER, LDD
	103	10/13 →	B	A14NET

**Orlando**

1.4	103	06/12 →	B	LUJ
-----	-----	---------	---	-----

**Trax**

1.4	103	12/12 →	B	LUJ, LUV
1.4 AWD	103	12/12 →	B	LUJ
1.4 LPG	103	04/13 →		A14NET, B14NET

**OPEL**
**Adam**

1.2	51	10/12 →	B	A12XEL, B12XEL
1.4	64	10/12 →	B	A14XEL, B14XEL
	74	10/12 →	B	A14XER, B14XER
1.4 LPG	64	07/13 →		A14XEL, B14XEL
1.4 S	110	11/14 →	B	B14NEH

**Astra J, Station Wagon, GTC**

1.4	88	10/11 →	B	A14NEL, B14NEL
	103	10/11 →	B	A14NET, B14NET
	64	12/09 →	B	A14XEL
1.4	74	10/11 →	B	A14XER
1.4 LPG	103	01/12 →		A14NET
1.4 Turbo	88	10/10 →	B	A14NEL, B14NEL
	103	12/09 →	B	A14NET
	103	10/10 →	B	A14NET, B14NET

**Cascada (W13)**

1.4	88	03/13 →	B	A14NEL
1.4 Turbo	103	03/13 →	B	A14NET

**Combo A**

1.4 16V	66	08/99 → 10/01	B	X14XE
---------	----	---------------	---	-------

**84027** NEW **350984027000**

**OPEL**
**Corsa D, Van**

1.2	51	06/10 →	B	A12XEL
	63	06/10 →	B	A12XER
1.2 LPG	61	06/11 →		A12XER
	63	08/11 →		A12XER
1.4	88	07/12 →	B	A14NEL
	64	09/09 →	B	A14XEL
	74	06/10 →	B	A14XER
1.4 LPG	64	09/09 →		A14XEL

**Corsa E, Van**

1.2	51	09/14 →	B	B12XEL
1.4	55	09/14 →	B	B14XEJ
	66	09/14 →	B	B14XEL
1.4 LPG	66	03/15 →		B14XEL
1.4 Turbo	74	09/14 →	B	B14NEJ
	110	03/15 →	B	B14NEH

**Insignia, Station Wagon**

1.4	103	09/11 →	B	A14NET
	103	04/11 →	B	A14NET, B14NET
1.4 LPG	103	07/12 →		A14NET

**Meriva B**

1.4	88	06/10 →	B	A14NEL, B14NEL
	103	06/10 →	B	A14NET, B14NET
	74	06/10 →	B	A14XER, B14XER
1.4 LPG	88	06/11 →		A14NEL, B14NEL

**Mokka**

1.4	103	04/13 →	B	A14NET, B14NET
1.4 4x4	103	06/12 →	B	A14NET, B14NET
1.4 LPG	103	04/13 →		A14NET

**Zafira C**

1.4	88	10/11 →	B	A14NEL, B14NEL
	103	10/11 →	B	A14NET, B14NET
1.4 LPG	103	10/11 →		A14NET, B14NET

**84027** NEW **350984027000**



**VAUXHALL**

**ASTRA**

1.4	64	12/09 →	B	A14XEL
	74	12/09 →	B	A14XER
1.4 Turbo	103	12/09 →	B	A14NET

**84028** NEW **350984028000**

**PULEGGIA**

Diametro Puleggia Ø84.7

Altezza Puleggia 32

Posizione Attacco 50.7

Diametro Girante Ø56

N° Alette Girante 7

Posizione Girante 18



**TOYOTA**

**IQ**

1.4 D-4D	66	01/09 →	D	1ND-TV
----------	----	---------	---	--------

**84029** NEW **350984029000**

**PULEGGIA**

Diametro Puleggia Ø84.7

Altezza Puleggia 32

Posizione Attacco 51.9

Diametro Girante Ø56

N° Alette Girante 7

Posizione Girante 18.1



**SUBARU**

**Trezia**

1.4 D	66	03/11 →	D	1ND-TV
-------	----	---------	---	--------

**TOYOTA**

**Auris I, Van**

1.4 D-4D	66	03/07 → 09/12	D	1ND-TV	02-2009 →
----------	----	---------------	---	--------	-----------

**Auris II, Touring Sports, Van**

1.4 D-4D	66	10/12 →	D	1ND-TV
----------	----	---------	---	--------

**Corolla VIII, Hatchback, Station Wagon**

1.4 D-4D	66	01/07 →	D	1ND-TV	02-2009 →
----------	----	---------	---	--------	-----------

**Corolla IX, Hatchback, Station Wagon**

1.4 D-4D	66	06/13 →	D	1ND-TV
----------	----	---------	---	--------

**Corolla Verso**

1.4 D-4D	66	03/04 → 03/09	D	1ND-TV	02-2009 →
----------	----	---------------	---	--------	-----------

**84029** NEW **350984029000**



**TOYOTA**

**Urban Cruiser**

1.4 D-4D	66	04/09 →	D	1ND-TV
----------	----	---------	---	--------

1.4 D-4D 4WD	66	04/09 →	D	1ND-TV
--------------	----	---------	---	--------

**Verso S**

1.4 D4-D	66	11/10 →	D	1ND-TV
----------	----	---------	---	--------

**Yaris III**

1.4 D-4D	66	09/11 →	D	1ND-TV
----------	----	---------	---	--------

**84030** NEW **350984030000**

**PULEGGIA**

Diametro Puleggia Ø110

Altezza Puleggia 29

Posizione Attacco 38.7

Diametro Girante Ø61

N° Alette Girante 7

Posizione Girante 18.1



**TOYOTA**

**Auris I, Van**

1.6	97	05/09 → 09/12	B	1ZR-FAE
-----	----	---------------	---	---------

1.6 VVTi	91	03/07 → 09/12	B	1ZR-FE
----------	----	---------------	---	--------

1.8	106	02/09 → 09/12	B	2ZR-FAE
	108	02/09 → 09/12	B	2ZR-FAE

1.8 4WD	100	02/09 → 09/12	B	2ZR-FAE
---------	-----	---------------	---	---------

**Auris II, Touring Sports, Van**

1.6	97	10/12 →	B	1ZR-FAE
-----	----	---------	---	---------

**Avensis III, Liftback, Station Wagon**

1.6	97	02/09 →	B	1ZR-FAE
-----	----	---------	---	---------

1.8	108	02/09 →	B	2ZR-FAE
-----	-----	---------	---	---------

2.0	112	02/09 →	B	3ZR-FAE, 3ZR-FE
-----	-----	---------	---	-----------------

**Corolla VIII, Hatchback, Station Wagon**

1.6	97	01/09 →	B	1ZR-FAE, 1ZR-FE
-----	----	---------	---	-----------------

1.6 Dual VVTi	91	01/07 →	B	1ZR-FE
---------------	----	---------	---	--------

1.6 VVTi	90	10/12 →	B	1ZR-FE
----------	----	---------	---	--------

**Corolla IX, Hatchback, Station Wagon**

1.6	97	06/13 →	B	1ZR-FAE
-----	----	---------	---	---------

1.8 VVTi	103	06/13 →	B	2ZR-FBE, 2ZR-FE
----------	-----	---------	---	-----------------

**84030** **NEW** 350984030000

**TOYOTA**
**RAV 4 III**

2.0	116	12/08 →	B	3ZR-FAE
2.0 4WD	116	12/08 →	B	3ZR-FAE
2.0 VVT-i	109	03/09 →	B	3ZR-FAE
2.0 VVT-i 4WD	109	03/09 →	B	3ZR-FAE

**RAV 4 IV**

2.0 VVT-i	107	12/12 →	B	3ZR-FE
2.0 VVT-i 4WD	111	12/12 →	B	3ZR-FAE

**Verso**

1.6	97	04/09 →	B	1ZR-FAE
1.8	108	04/09 →	B	2ZR-FAE

**Yaris II**

1.8 VVTi	98	01/07 →	B	2ZR-FE
----------	----	---------	---	--------

**84031** **NEW** 350984031000

**PULEGGIA**

Diametro Puleggia	Ø85
Altezza Puleggia	32.5
Posizione Attacco	54.5
Diametro Girante	Ø45
N° Alette Girante	6
Posizione Girante	20.2

**TOYOTA**
**IQ**

1.0	50	01/09 →	B	1KR-FE
-----	----	---------	---	--------

**84032** **NEW** 350984032000

**PULEGGIA**

Diametro Puleggia	Ø94.8
Altezza Puleggia	30.7
Posizione Attacco	49
Diametro Girante	Ø44.6
N° Alette Girante	6
Posizione Girante	19.1

**DAIHATSU**
**Charade VI**

1.33 16V	73	05/11 →	B	1NR-FE
----------	----	---------	---	--------

**SUBARU**
**Trezia**

1.3	73	03/11 →	B	1NR-FE, 1NR-FKE
-----	----	---------	---	--------------------

**TOYOTA**
**Auris I, Van**

1.33	73	01/10 → 09/12	B	1NR-FE
Dual-VVTi	74	05/09 → 09/12	B	1NR-FE

**Auris II, Touring Sports, Van**

1.3	73	10/12 →	B	1NR-FE
-----	----	---------	---	--------

**Corolla VIII, Hatchback, Station Wagon**

1.33	74	01/07 →	B	1NR-FE
------	----	---------	---	--------

**Corolla IX, Hatchback, Station Wagon**

1.3	73	06/13 →	B	1NR-FE
-----	----	---------	---	--------

**Urban Cruiser**

1.33	73	04/10 →	B	1NR-FE
	74	04/09 →	B	1NR-FE

**Verso S**

1.33	70	11/10 →	B	1NR-FE
	73	11/10 →	B	1NR-FE

**Yaris II**

1.33 VVT-i	73	07/10 →	B	1NR-FE
	74	03/09 →	B	1NR-FE

**Yaris III**

1.3	70	09/11 →	B	1NR-FE
	73	09/11 →	B	1NR-FE, 1NR-FKE
1.3 4WD	70	12/10 →	B	1NR-FE

**84033**
**NEW**
**350984033000**

**PULEGGIA**

Diametro Puleggia	Ø54.7
Numero Denti/Gole Puleggia	22
Altezza Puleggia	32
Posizione Attacco	75.7
Diametro Girante	Ø84.7
N° Alette Girante	7
Posizione Girante	36.15

**KW**

**CHRYSLER**
**Grand Voyager V**

2.8 CRD	120	10/07 →	D	
	120	10/07 →	D	ENS

**Voyager IV**

2.5 CRD	88	08/05 → 12/08	D	EDK
	105	02/00 → 12/08	D	ENJ
2.8 CRD	110	06/04 → 12/08	D	ENR

**84034**
**NEW**
**350984034000**

**FLANGIA**

Numero Fori Flangia	3
Dimensione Fori Flangia	M8×1.25
Posizione Attacco	46.7
Diametro Mozzo	Ø28
Diametro Girante	Ø66
N° Alette Girante	5
Posizione Girante	39

**KW**

**MERCEDES-BENZ**
**Classe C IV (W205), Station Wagon (S205), Coupé(C205)**

C 180 BlueTEC / d	85	05/14 →	D	OM626.951
-------------------	----	---------	---	-----------

C 200 BlueTEC / d	100	05/14 →	D	OM626.951
-------------------	-----	---------	---	-----------

**Vito III (W447)**

109 CDI	65	10/14 →	D	OM622.951
---------	----	---------	---	-----------

109 CDI / 109 BlueTEC	65	10/14 →	D	OM622.951
-----------------------	----	---------	---	-----------

111 CDI	84	10/14 →	D	OM622.951
---------	----	---------	---	-----------

111 CDI / 111 BlueTEC	84	10/14 →	D	OM622.951
-----------------------	----	---------	---	-----------

**84034**
**NEW**
**350984034000**

**KW**

**NISSAN**
**Qashqai I**

1.6 dCi	96	10/11 →	D	R9M
---------	----	---------	---	-----

1.6 dCi Trazione integrale	96	10/11 →	D	R9M
----------------------------	----	---------	---	-----

**Qashqai II**

1.6 dCi	96	11/13 →	D	R9M
---------	----	---------	---	-----

1.6 dCi 4x4	96	11/13 →	D	R9M
-------------	----	---------	---	-----

**X-Trail III**

1.6 dCi	96	12/13 →	D	R9M
---------	----	---------	---	-----

1.6 dCi 4x4	96	12/13 →	D	R9M
-------------	----	---------	---	-----

**RENAULT**
**Espace V**

1.6 dCi 130	96	06/15 →	D	R9M409
-------------	----	---------	---	--------

1.6 dCi 160	118	06/15 →	D	R9M452
-------------	-----	---------	---	--------

**Grand Scénic III**

1.6 dCi	96	04/11 →	D	R9M402, R9M404
---------	----	---------	---	----------------

**Kadjar**

1.6 dCi 130	96	06/15 →	D	R9M414
-------------	----	---------	---	--------

1.6 dCi 130 4x4	96	06/15 →	D	R9M414
-----------------	----	---------	---	--------

**Megane III, Station Wagon, Coupé, CC**

1.6 dCi	96	04/11 →	D	R9M402
	96	04/11 →	D	R9M402, R9M404

**Megane IV**

1.6 dCi 130	96	11/15 →	D	
-------------	----	---------	---	--

1.6 dCi	96	04/11 →	D	R9M402, R9M404
---------	----	---------	---	----------------

**84035** NEW **350984035000**

	<b>PULEGGIA</b>		
	Diametro Puleggia	Ø54.7	
	Numero Denti/Gole Puleggia	22	
	Altezza Puleggia	31.8	
	Posizione Attacco	76	
	Diametro Girante	Ø84.9	
	N° Alette Girante	7	
Posizione Girante	36.15		

**JEEP**
**Cherokee III (KJ)**

2.5 CRD 4x4	105	09/01 → 01/08	D	R425DOHC
2.8 CRD 4x4	110	11/02 → 01/08	D	ENR
	120	11/04 → 01/08	D	ENR

**Cherokee IV (KK)**

2.8 CRD 4x4	130	05/08 →	D	ENS
----------------	-----	---------	---	-----

**Wrangler II**

2.8 CRDi	130	11/06 → 04/07	D	ENS
----------	-----	---------------	---	-----

**84036** NEW **350984036000**

	<b>FLANGIA</b>		
	Numero Fori Flangia	3	
	Dimensione Fori Flangia	M8x1.25	
	Posizione Attacco	69.2	
	Diametro Centraggio	Ø32.9	
	Diametro Girante	Ø47.8	
	N° Alette Girante	6	
Posizione Girante	10.7		

**FORD**
**B-Max, Van**

1.0 EcoBoost	74	10/12 →	B	SFJA, SFJB, SFJC, SFJD
	88	10/12 →	B	M1JA
	92	10/12 →	B	M1JE

**C-Max II, Van**

1.0	74	10/12 →	B	M2DA, SFDA
EcoBoost	92	10/12 →	B	M1DA

**Ecosport II**

1.0	92	10/13 →	B	M1JC
EcoBoost	103	03/16 →	B	YYJD

**84036** NEW **350984036000**
**FORD**
**Fiesta VI, Van**

1.0	48	01/13 →	B	XMJA, XMJB
	59	10/12 →	B	P4JA, P4JB, P4JC, P4JD
1.0 EcoBoost	48	01/13 →	B	XMJA, XMJB
	59	10/12 →	B	P4JA, P4JB, P4JC, P4JD
	74	01/13 →	B	SFJA, SFJB, SFJC, SFJD
	92	09/12 →	B	M1JE
	92	09/12 →	B	M1JE, M1JH
	103	05/14 →	B	YYJA, YYJB
1.0 Sport	103	05/14 →	B	YYJA, YYJB

**Focus III, Station Wagon, Van**

1.0	74	02/12 →	B	M2DA
EcoBoost	92	02/12 →	B	M1DA

**Grand C-Max**

1.0	74	10/12 →	B	M2DA, SFDA
EcoBoost	92	10/12 →	B	M1DA

**Mondeo V, Station Wagon**

1.0	92	02/15 →	B	M1CA, M1CB
-----	----	---------	---	------------

**Tourneo II Connect, Courier, Custom**

1.0	74	11/13 →	B	M2GA, M2GB
-----	----	---------	---	------------

**Transit Connect II, Courier**

1.0	74	02/13 →	B	M2GA
-----	----	---------	---	------

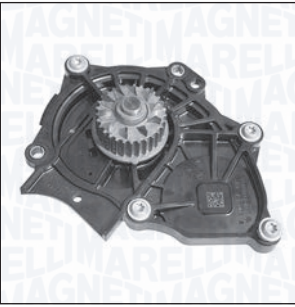

<b>PULEGGIA</b>	
Diametro Puleggia	Ø45
Numero Denti/Gole Puleggia	29
Altezza Puleggia	18
Posizione Attacco	32.9
Diametro Girante	Ø64.8
N° Alette Girante	5
Posizione Girante	25.5



**AUDI**

**A1, Sportback**

1.8 TFSI	141	02/15 →	B	DAJB
S1 quattro	170	03/14 →	B	CWZA

**A3 III, Sportback, Cabriolet**

1.8 TFSI	125	05/14 →	B	CNSB
	132	04/12 →	B	CJSA
	132	05/13 →	B	CJSA, CJSB
1.8 TFSI quattro	132	08/12 →	B	CJSB
S3 quattro	206	02/13 →	B	CJXB
	210	05/14 →	B	CJXF
	221	11/12 →	B	CJXC

**A4 IV, Avant, Allroad**

1.8 TFSI	125	11/11 → 12/15	B	CJEB
1.8 TFSI quattro	125	11/11 → 12/15	B	CJEB
2.0 TFSI	165	05/13 → 12/15	B	CNCD
2.0 TFSI quattro	165	05/13 → 12/15	B	CNCD

**A4 V, Avant, Allroad**

2.0 TFSI	140	05/15 →	B	CVKB
	183	11/15 →	B	CYRC
	185	05/15 →	B	CYMC, CYRB
2.0 TFSI quattro	183	11/15 →	B	CYRC
	185	05/15 →	B	CYMC, CYRB
2.0 TFSI quattro	185	08/15 →	B	CYRB

**A5, Sportback, Cabriolet**

1.8 TFSI	106	09/14 →	B	CJED
	125	10/11 →	B	CABD, CJEB
	125	08/11 →	B	CJEB
	130	05/15 →	B	CJEE
2.0 TFSI	155	03/09 →	B	CAEB, CDNC 08-2011 →
	155	06/08 →	B	CDNC 08-2011 →
	169	08/15 →	B	CNCE
2.0 TFSI quattro	155	06/08 →	B	CAEB, CDNC 08-2011 →
	155	09/09 →	B	CDNC 08-2011 →



**AUDI**

**A5, Sportback, Cabriolet**

2.0 TFSI quattro	169	08/15 →	B	CNCE
------------------	-----	---------	---	------

**A6 IV, Avant, Allroad**

1.8 TFSI	140	09/14 →	B	CYGA
2.0 TFSI	185	09/14 →	B	CYNB, CYPA
2.0 TFSI quattro	183	05/15 →	B	CYPB
	185	05/14 →	B	CYNB, CYPA
	185	05/15 →	B	CYPA

**A7**

1.8 TFSI	140	04/15 →	B	CYGA
2.0 TFSI	185	09/14 →	B	CYPA
2.0 TFSI quattro	183	05/15 →	B	CYPB
	185	05/15 →	B	CYNB, CYPA

**Q3**

2.0 TFSI	132	05/15 →	B	CULB
2.0 TFSI quattro	132	11/14 →	B	CULB

**Q5**

2.0 TFSI quattro	165	06/12 →	B	CNCD
------------------	-----	---------	---	------

**TT III, Roadster**

1.8 TFSI	132	08/15 →	B	CJSA
2.0 TFSI	169	07/14 →	B	CHHC
2.0 TFSI quattro	169	07/14 →	B	CHHC
	215	07/15 →	B	CYFB
2.0 TTS	210	02/15 →	B	CJXF
2.0 TTS quattro	228	11/14 →	B	CJXG

**SEAT**

**Alhambra II**

2.0 TSI	162	05/15 →	B	DEDA
---------	-----	---------	---	------

**Leon III**

1.8 TSI	132	02/13 →	B	CJSA, CJSB
1.8 TSI 4Drive	132	11/14 →	B	CJSA
2.0 Cupra	195	10/13 →	B	CJXE
	206	10/13 →	B	CJXA

**SKODA**

**Octavia III, Station Wagon**

1.8 TSI	132	11/12 →	B	CJSA
	132	11/12 →	B	CJSA, CJSB
1.8 TSI 4x4	132	09/14 →	B	CJSA
	132	11/12 →	B	CJSB
2.0 TSI RS	162	05/13 →	B	CHHB
	169	05/15 →	B	CHHA

**84037**
**NEW**
**350984037000**

**KW**

**SKODA**
**Superb**

1.8 TSI	132	03/15 →	B	CJSA, CJSC
2.0 TSI	162	03/15 →	B	CHHB
2.0 TSI 4x4	206	03/15 →	B	CJXA

**VOLKSWAGEN**
**Beetle II (Maggiolino)**

2.0 TSI	155	12/12 →	B	CPLA, CPPA
	162	12/14 →	B	CULC

**Golf VII, Variant, Cabrio, AllTrack**

1.8 TSI 4motion	132	12/14 →	B	CJSB
2.0 GTI	155	11/13 →	B	CNTA, CXCA
	162	04/13 →	B	CHHB, CXDA
	169	04/13 →	B	CHHA
	195	02/16 →	B	CJXE
2.0 R 4motion	206	11/13 →	B	CJXB
	221	11/13 →	B	CJXC

**Jetta IV**

2.0 TSI	155	12/12 →	B	CPLA, CPPA
---------	-----	---------	---	------------

**Passat VIII, Variant, AllTrack**

1.8 TSI	132	02/15 →	B	CJSA, CJSC
2.0 TSI	162	02/15 →	B	CHHB, CXDA
2.0 TSI 4motion	162	07/15 →	B	CHHB

**Polo VI (6R)**

1.8 GTI	136	11/14 →	B	CWYA
	141	11/14 →	B	DAJA, DAJB

**Scirocco III**

2.0 R	206	05/14 →	B	CDLK
2.0 TSI	132	11/13 →	B	CULA
	162	11/13 →	B	CULC

**Sharan II**

2.0 TSI	162	05/15 →	B	DEDA
---------	-----	---------	---	------

**Tiguan II**

2.0 TSI 4motion	132	02/16 →	B	
-----------------	-----	---------	---	--

**84038**
**NEW**
**350984038000**

**KW**

**PULEGGIA**

Diametro Puleggia	Ø59.85
Numero Denti/Gole Puleggia	20
Altezza Puleggia	32.3
Posizione Attacco	62
Diametro Girante	Ø61.5
N° Alette Girante	8
Posizione Girante	22.2

**KW**

**CITROËN**
**C 4 I, Coupé, Picasso, Grand Picasso**

1.8 Bifuel	92	01/09 → 10/12	BF	6FY (EW7A)	(-)COP
1.8 i 16V	92	10/06 →	B	6FY (EW7A)	(-)COP
2.0 16V	100	11/04 → 07/07	B	RFN(EW10J4)	(-)COP
	103	11/04 → 07/11	B	RFJ(EW10A)	(-)COP
	130	11/04 → 12/10	B	RFK (EW10J4S)	(-)COP
2.0 i 16V	103	10/06 →	B	RFJ(EW10A)	(-)COP
2.0 VTR	103	10/06 → 12/07	B	RFJ(EW10A)	(-)COP

**C 5 I, Break**

1.8 16V	85	03/01 → 08/04	B	6FZ (EW7J4)	(-)COP
2.0 16V	100	03/01 → 08/04	B	RFN(EW10J4)	(-)COP
2.0 16V HPI	103	03/01 → 08/04	B	RLZ(EW10D)	(-)COP

**C 5 II, Break**

1.8 16V	92	09/05 →	B	6FY (EW7A)	(-)COP
	85	09/04 →	B	6FZ (EW7J4)	(-)COP
2.0 16V	103	09/04 →	B	RFJ(EW10A)	(-)COP

**C 5 III, Break**

1.8 16V	92	02/08 →	B	6FY (EW7A)	(-)COP
2.0 16V	103	02/08 →	B	RFJ(EW10A)	(-)COP
2.0 16V BioFlex	103	02/08 →		RFJ(EW10A)	(-)COP

**C 8**

2.0	100	07/02 →	B	RFN(EW10J4)	(-)COP
2.0 16V	103	09/05 →	B	RFJ(EW10A)	(-)COP
	104	09/05 →	B	RFJ(EW10A)	(-)COP
2.2	116	07/02 →	B	3FZ (EW12J4)	(-)COP

**Evasion**

2.0 16V	100	05/00 → 07/02	B	RFN(EW10J4)	(-)COP
---------	-----	---------------	---	-------------	--------

**Jumpy I**

2.0	100	04/00 → 12/06	B	RFN(EW10J4)	(-)COP
2.0 i 16V	102	03/00 →	B	RFN(EW10J4)	(-)COP

**Jumpy II**

2.0	100	12/03 → 10/06	B	RFN(EW10J4)	(-)COP
-----	-----	---------------	---	-------------	--------

**Jumpy III**

2.0 i	103	01/07 →	B	RFH(EW10A)	(-)COP
-------	-----	---------	---	------------	--------

**84038**
**NEW**
**350984038000**

**CITROËN**
**Xsara, Break, Coupé, Picasso, Van**

1.8 16V	85	02/00 →	B	6FZ (EW7J4)	(-)COP
1.8 VTS	85	09/00 → 10/04	B	6FZ (EW7J4)	(-)COP
2.0 16V	100	09/00 → 03/05	B	RFN (EW10J4)	(-)COP

**FIAT**
**Doblò II, Cargo**

1.4	70	04/10 →	B	843A1.000	(-)COP
-----	----	---------	---	-----------	--------

**Scudo I**

2.0	100	05/00 → 12/06	B	RFN (EW10J4)	(-)COP
2.0 16V	100	06/00 → 12/06	B	RFN (EW10J4)	(-)COP

**Ulysse II**

2.0	100	08/02 → 06/11	B	RFN (EW10J4)	(-)COP
-----	-----	---------------	---	--------------	--------

**LANCIA**
**Phedra**

2.0	100	09/02 → 11/10	B	RFN (EW10J4)	(-)COP
-----	-----	---------------	---	--------------	--------

**Zeta**

2.0 16V	100	07/00 → 09/02	B	RFN	(-)COP
---------	-----	---------------	---	-----	--------

**PEUGEOT**
**205 II, Van**

2.0 RC	130	07/03 →	B	RFK (EW10J4S)	(-)COP
2.0 S16	99	04/99 → 10/00	B	RFR (DEW10J4)	(-)COP
	100	06/99 →	B	RFN (EW10J4)	(-)COP

**206, CC, Van**

2.0 16V	100	07/02 →	B	RFN (EW10J4)	(-)COP
2.0 S16	100	09/00 →	B	RFN (EW10J4)	(-)COP

**307, Station Wagon, CC**

2.0	100	03/02 →	B	RFN (EW10J4)	(-)COP
	105	08/08 →	B	RFN (EW10J4)	(-)COP
2.0 16V	100	08/00 →	B	RFN (EW10J4)	(-)COP
	103	03/05 →	B	RFJ (EW10A)	(-)COP
	103	03/05 →	B	RFJ (EW10A), RFN (EW10J4)	(-)COP
	130	06/05 →	B	RFK (EW10J4S)	(-)COP

**308 I, Station Wagon, CC**

2.0 Bioflex	103	01/08 → 01/12		RFJ (EW10A)	(-)COP
2.0 CVVT	103	07/09 → 11/14	B	RFJ (EW10A)	(-)COP

**407, Station Wagon, Coupé**

1.8	85	05/04 →	B	6FZ (EW7J4)	(-)COP
1.8 16V	92	09/05 →	B	6FY (EW7A)	(-)COP
2.0	100	05/04 →	B	RFN (EW10J4)	(-)COP

**84038**
**NEW**
**350984038000**

**PEUGEOT**
**407, Station Wagon, Coupé**

2.0 16V	99	01/99 → 08/00	B	RFR (DEW10J4)	(-)COP
	100	08/00 → 06/04	B	RFN (EW10J4)	(-)COP
	100	10/00 → 12/04	B	RFN (EW10J4), RFV (XU10J4R)	(-)COP
2.0 16V	103	09/05 →	B	RFJ (EW10A)	(-)COP
	97	11/95 → 05/04	B	RFV (XU10J4R)	(-)COP
	103	05/01 → 05/04	B	RLZ (EW10D)	(-)COP
2.0 Bioflex	103	09/07 →		RFJ (EW10A)	(-)COP
2.2	116	07/00 → 05/04	B	3FZ (EW12J4)	(-)COP
2.2 16V	120	09/05 →	B	3FY (EW12J4)	(-)COP
<b>607</b>					
2.0	100	02/00 →	B	RFN (EW10J4)	(-)COP
2.2 16V	116	02/00 →	B	3FZ (EW12J4)	(-)COP
	120	09/05 →	B	3FY (EW12J4)	(-)COP
<b>806</b>					
2.0 16V	100	09/00 → 08/02	B	RFN (EW10J4)	(-)COP
<b>807</b>					
2.0	100	06/02 →	B	RFN (EW10J4)	(-)COP
2.0 16V	103	09/05 →	B	RFJ (EW10A)	(-)COP
2.2	116	06/02 →	B	3FZ (EW12J4)	(-)COP
<b>Expert I</b>					
2.0	100	07/00 →	B	RFN (EW10J4)	(-)COP
<b>Expert II, Tepee</b>					
2.0 16V	103	01/07 →	B	RFH (EW10A), RFJ (EW10A)	(-)COP



**84039**
**NEW**
**350984039000**

**PULEGGIA**

Diametro Puleggia	Ø59.26
Numero Denti/Gole Puleggia	20
Altezza Puleggia	30.5
Posizione Attacco	49.7
Diametro Girante	Ø59.5
N° Alette Girante	8
Posizione Girante	24.8

**KW**

**DACIA**
**Duster**

1.6 16V	77	04/10 →	B	K4M690, K4M696
1.6 16V 4x4	77	06/10 →	B	K4M606
1.6 16V Hi-Flex	77	08/10 →		K4M696
1.6 16V LPG	77	04/11 →		K4M696

**Lodgy**

1.6 LPG	61	11/13 →		K7M812, K7M828
---------	----	---------	--	-------------------

**Logan**

1.6 16V	77	01/13 →	B	K4M842
---------	----	---------	---	--------

**Logan MCV**

1.6 16V	77	02/07 →	B	K4M690, K4M696
1.6 16V Hi-Flex	77	11/09 →		K4M690, K4M694
1.6 MPI 85	62	05/10 →	B	K7M800

**Logan, Station Wagon, Van**

1.6 16V	77	02/06 →	B	K4M690, K4M696
1.6 16V Flexifuel	77	07/10 →		K4M696
1.6 Bifuel	62	05/10 →	BF	K7M800
1.6 MPI 85	62	05/10 →	B	K7M800

**Sandero I**

1.6 16V	77	07/11 →	B	K4M690
1.6 16V Bifuel	77	01/11 →	BF	K4M690, K4M694, K4M696
1.6 MPI 85	62	05/10 →	B	K7M800

**Sandero II**

1.6	61	11/12 →	B	K7M812
1.6 16V	77	01/13 →	B	K4M842, K4M845

**84039**
**NEW**
**350984039000**

**KW**

**NISSAN**
**Kubistar**

1.6 16V	70	08/03 → 10/09	B	K4M752
---------	----	---------------	---	--------

**RENAULT**
**Clio II**

1.4 16V	70	10/99 → 09/04	B	K4J712, K4J713
	72	08/00 →	B	K4J710, K4J711, K4J712, K4J713
1.6 16V	79	09/98 →	B	K4M708, K4M740, K4M742, K4M743, K4M744, K4M745, K4M748
1.6 Hi-Flex	86	01/05 → 02/10		K4M748

**Clio III, Grandtour**

1.4 16V	72	02/10 →	B	K4J780
1.6 16V	65	06/05 →	B	K4M804
	82	02/08 →	B	K4M800, K4M801
	94	11/08 →	B	K4M862
1.6 16V GT	94	06/09 →	B	K4M862
1.6 Hi-Flex	86	05/05 → 02/10		K4M748

**Duster**

1.6 16V	75	02/12 →	B	K4M616
---------	----	---------	---	--------

**Fluence**

1.6 16V	82	02/10 →	B	K4M838
	81	02/10 →	B	K4M838, K4M839

**Grand Scénic II**

1.6	77	06/06 →	B	K4M788
	82	06/06 → 11/08	B	K4M812
	83	04/04 →	B	K4M761, K4M782

**Grand Scénic III**

1.6 16V	81	02/09 →	B	K4M858
1.6 16V Bifuel	81	02/09 →	BF	K4M866

**84039**
**NEW**
**350984039000**

**KW**

**RENAULT**
**Kangoo I, Van**

1.6 16V	70	06/01 →	B	K4M706, K4M750, K4M752, K4M753
	70	10/01 →	B	K4M706, K4M752
1.6 16V 4x4	70	10/01 →	B	K4M750, K4M752, K4M753
1.6 16V bivalent	60	06/05 →		K4M850

**Kangoo II, Be Bop, Van**

1.6	78	02/09 →	B	K4M830
1.6 16V	78	02/08 →	B	K4M830
	78	02/08 →	B	K4M830, K4M831
1.6 16V Hi-Flex	78	02/08 →		K4M834, K4M850
1.6 16V LPG	72	02/08 →		K4M834

**Laguna I, Grantour**

1.6 16V	79	11/97 → 03/01	B	K4M720, K4M724
---------	----	---------------	---	-------------------

**Laguna II, Grantour**

1.6 16V	82	02/05 →	B	K4M716
	79	03/01 →	B	K4M710, K4M714
	82	02/05 →	B	K4M716
1.6 FlexFuel	76	06/01 → 10/03		K4M718
1.8 16V	85	03/01 →	B	F4P770, F4P771, F4P773, F4P774, F4P775

**Laguna III, Grantour, Coupé**

1.6 16V	81	10/07 →	B	K4M824
---------	----	---------	---	--------

**Logan I, Station Wagon**

1.6	77	04/07 →	B	K4M690
-----	----	---------	---	--------

**Logan I, Station Wagon, Express**

1.6	77	04/07 →	B	K4M697
-----	----	---------	---	--------

**Megane I, Coach, Cabrio, Scénic, Station Wagon**

1.4 16V	70	03/99 → 08/03	B	K4J714, K4J750
---------	----	---------------	---	-------------------

**84039**
**NEW**
**350984039000**

**KW**

**RENAULT**
**Megane I, Coach, Cabrio, Scénic, Station Wagon**

1.6 16V	79	03/99 → 08/03	B	K4M700, K4M701, K4M704, K4M708
	79	03/99 → 08/03	B	K4M700, K4M701, K4M708
1.6 LPG	80	10/00 → 08/02		K4M704

**Megane II, Station Wagon, Coupé-Cabrio**

1.4	60	09/03 →	B	K4J732
	72	08/03 → 07/09	B	K4J730, K4J740
1.4 16V	60	10/03 → 02/08	B	K4J732
	72	11/02 → 02/08	B	K4J730, K4J740
1.6	75	09/03 →	B	K4M768
	77	05/05 →	B	K4M762
	77	06/05 → 02/08	B	K4M788
1.6	83	09/03 → 03/09	B	K4M760, K4M761
	77	05/05 → 07/09	B	K4M762
	82	01/06 → 06/08	B	K4M760, K4M761, K4M812, K4M813
1.6 16V	82	01/06 → 06/08	B	K4M760, K4M812, K4M813
	82	01/06 →	B	K4M812, K4M813
	83	11/02 → 02/08	B	K4M760
1.6 16V Hi-Flex	77	02/08 → 07/09		K4M856
1.6 Flex-Fuel	77	01/07 → 02/08		K4M788

**Megane III, Station Wagon, Coupé, CC**

1.6 16V	82	11/08 →	B	K4M858, K4M866
	74	11/08 →	B	K4M848
	81	06/10 →	B	K4M858
1.6 16V Bifuel	81	11/08 →	BF	K4M866
1.6 TCe	96	01/11 →	B	

**84039** NEW **350984039000**

**RENAULT**
**Modus**

1.4	72	12/04 →	B	K4J770, K4J780
1.6	65	12/04 →	B	K4M794
	82	12/04 →	B	K4M790, K4M791, K4M800, K4M801

**Scénic I**

1.4 16V	70	09/99 → 08/03	B	K4J714, K4J750
1.6	79	09/99 → 09/03	B	K4M700, K4M706
1.6 BiFuel	79	09/99 → 04/01	BF	K4M704

**Scénic II**

1.4	72	06/03 →	B	K4J730, K4J740, K4J770
1.6	77	06/06 →	B	K4M788
	83	06/03 →	B	K4M761, K4M782
1.6 16V	82	10/05 →	B	K4M706, K4M766, K4M812, K4M813

**Scénic III**

1.6 16V	81	02/09 →	B	K4M858
1.6 E85	81	02/09 →	FF	K4M866

**Thalia I**

1.4 16V	72	08/00 →	B	K4J712
1.6 16V	79	04/02 →	B	K4M740

**Thalia II**

1.6 16V	77	09/08 →	B	K4M743
---------	----	---------	---	--------

**Twingo II**

1.6 RS	98	05/08 →	B	K4M854
--------	----	---------	---	--------

**Wind**

1.6	98	07/10 →	B	K4M854
-----	----	---------	---	--------

**84040** NEW **350984040000**

**FLANGIA**

Numero Fori Flangia	4
Dimensione Fori Flangia	M6X1
Posizione Attacco	49.7
Diametro Centraggio	Ø24
Diametro Girante	Ø49.5
N° Alette Girante	6
Posizione Girante	31.5

**HYUNDAI**
**i10 I**

1.2	63	04/11 →	B	G4LA
-----	----	---------	---	------

**i10 II**

1.2	64	12/13 →	B	G4LA
-----	----	---------	---	------

**i20 I**

1.2	57	09/08 →	B	G4LA
	63	03/12 →	B	G4LA

**i20 II, Coupé**

1.2	55	11/14 →	B	G4LA
	62	11/14 →	B	G4LA

**KIA**
**Picanto II**

1.2	63	09/11 →	B	G4LA
-----	----	---------	---	------

**Rio III**

1.2 CVVT	62	11/14 →	B	G4LA
1.25 CVVT	63	09/11 →	B	G4LA
1.25 LPG	63	09/11 →		G4LA

**84042** NEW **350984042000**

**FLANGIA**

Numero Fori Flangia	4
Dimensione Fori Flangia	M6x1
Posizione Attacco	53
Diametro Centraggio	Ø28
Diametro Girante	Ø65
N° Alette Girante	8
Posizione Girante	20.7

**CITROËN**
**C 4 Aircross**

1.8 HDi 150	110	04/12 →	D	4N13
1.8 HDi 150 AWC	110	04/12 →	D	4N13

**84042**
**NEW**
**350984042000**

**KW**

**MITSUBISHI**
**ASX, Van**

1.8 Di-D	85	06/10 →	D	4N13
	110	06/10 →	D	4N13
1.8 Di-D 4WD	85	06/10 →	D	4N13
	110	06/10 →	D	4N13
2.2 Di-D 4WD	110	04/13 →	D	4N14

**Outlander II, Van**

2.2 Di-D	130	11/06 → 11/12	D	4N14
2.2 Di-D	103	09/10 → 11/12	D	4N14
4WD	130	11/06 → 11/12	D	4N14

**Outlander III, Van**

2.2 Di-D	110	08/12 →	D	4N14
2.2 Di-D 4WD	110	08/12 →	D	4N14

**PEUGEOT**
**4008**

1.8 HDi AWC	110	05/12 →	D	
----------------	-----	---------	---	--

**84043**
**NEW**
**350984043000**

**PULEGGIA**

Diametro Puleggia	Ø53
Altezza Puleggia	29
Posizione Attacco	54.1
Diametro Girante	Ø84.6
N° Alette Girante	6
Posizione Girante	40.4

**KW**

**CHRYSLER**
**Grand Voyager V**

2.8 CRD	132	09/12 →	D	ENS
---------	-----	---------	---	-----

**JEEP**
**Cherokee IV (KK)**

2.8 CRDi 4x4	147	01/10 →	D	ENS
-----------------	-----	---------	---	-----

**Wrangler III**

2.8 CRD	147	11/10 →	D	ENS
	130	04/07 →	D	ENS

**84044**
**NEW**
**350984044000**

**PULEGGIA**

Diametro Puleggia	Ø110
Numero Denti/Gole Puleggia	6
Altezza Puleggia	23
Posizione Attacco	46
Diametro Girante	Ø81.5
N° Alette Girante	7
Posizione Girante	11

**KW**

**MERCEDES-BENZ**
**Classe C III (W204), Station Wagon (S204), Coupé (C204)**

C 180 CDI	88	01/11 → 01/14	D	OM651.913
C 200 CDI	100	01/11 → 01/14	D	OM651.913
	120	10/08 → 01/14	D	OM651.911
C 220 CDI	120	06/11 →	D	OM651.911
	125	12/08 → 01/14	D	OM651.911
C 220 CDI 4-matic	125	02/13 → 01/14	D	OM651.912
C 250 CDI	150	08/08 → 01/14	D	OM651.911
C 250 CDI 4-matic	150	01/11 → 01/14	D	OM651.912

**Classe E IV (W212), Station Wagon (S212), Cabrio (A207), Coupé (C207)**

E 200 CDI / BlueTEC	100	01/09 →	D	OM651.925
E 220 BlueTEC	130	05/15 →	D	OM651.924
	130	05/14 →	D	OM651.911
	130	05/14 →	D	OM651.924
E 220 BlueTEC 4-matic	125	01/15 →	D	OM651.924
E 220 CDI	120	07/14 →	D	OM651.911
	120	01/09 →	D	OM651.924
	120	02/10 →	D	OM651.911
	120	08/09 →	D	OM651.924
E 220 CDI / BlueTEC	125	01/09 →	D	OM651.924
E 220 CDI / BlueTEC / d	125	01/10 →	D	OM651.911
E 220 CDI / d	125	01/10 →	D	OM651.911
E 250 CDI / BlueTEC	150	01/09 →	D	OM651.924
E 250 CDI / BlueTEC / d	150	01/10 →	D	OM651.911

**84044** **NEW** 350984044000

**MERCEDES-BENZ**
**Classe E IV (W212), Station Wagon (S212), Cabrio (A207), Coupé (C207)**

E 250 CDI / BlueTEC 4-matic	150	01/09 →	D	OM651.924
E 250 CDI/d	150	01/09 →	D	OM651.911
E 300 Hybrid / BlueTEC Hybrid	150	12/11 →		OM651.924

**Classe GLK (X204)**

200 CDI	105	07/10 →	D	OM651.913, OM651.916
220 CDI	120	12/08 →	D	OM651.916
	125	12/08 →	D	OM651.916
220 CDI 4-matic	120	12/08 →	D	OM651.912
	125	12/08 →	D	OM651.912
250 CDI 4-matic	150	09/09 →	D	OM651.912

**Classe M III (166)**

ML 250 CDI / BlueTEC 4-matic	150	06/11 →	D	OM651.960
------------------------------	-----	---------	---	-----------

**Classe S VI (W221), Coupé (C216)**

S 250 CDI	150	01/11 → 12/13	D	OM651.961
-----------	-----	---------------	---	-----------

**CLS II (C218), Shooting Brake (X218)**

CLS 220 BlueTEC	130	05/14 →	D	OM651.924
CLS 220 BlueTEC / d	120	05/14 →	D	OM651.924
CLS 220 BlueTEC / d	125	05/14 →	D	OM651.924
CLS 250 BlueTEC / d 4-matic	150	05/14 →	D	OM651.924
CLS 250 CDI / BlueTEC / d	150	04/11 →	D	OM651.924

**SLC (R172)**

250 d	150	01/16 →	D	OM651.980
-------	-----	---------	---	-----------

**SLK III (R172)**

250 CDI / d	150	01/12 →	D	OM651.980
-------------	-----	---------	---	-----------

**84045** **NEW** 350984045000

**AUDI**
**A1, Sportback**

1.2 TFSI	63	05/10 →	B	CBZA
----------	----	---------	---	------

**A3 II, Sportback, Cabriolet**

1.2 TFSI	77	03/10 → 05/13	B	CBZB
1.2 TSI	77	04/10 → 08/12	B	CBZB

**SEAT**
**Altea, Altea XL**

1.2 TSI	77	04/10 →	B	CBZB
---------	----	---------	---	------

**Ibiza V**

1.2 TSI	63	08/12 →	B	CBZA
	77	09/10 →	B	CBZB

**Leon II**

1.2 TSI	77	02/10 → 12/12	B	CBZB
---------	----	---------------	---	------

**Toledo IV**

1.2 TSI	63	07/12 →	B	CBZA
	77	07/12 →	B	CBZB

**SKODA**
**Fabia II, Station Wagon, Van**

1.2 TSI	63	03/10 → 12/14	B	CBZA
	77	03/10 → 12/14	B	CBZB

**Octavia II, Station Wagon**

1.2 TSI	77	02/10 → 06/13	B	CBZB
---------	----	---------------	---	------

**Rapid II**

1.2 TSI	63	07/12 →	B	CBZA
	77	07/12 →	B	CBZB

**Roomster, Van**

1.2 TSI	63	03/10 → 05/15	B	CBZA
	77	03/10 → 05/15	B	CBZB

**Yeti**

1.2 TSI	77	09/09 →	B	CBZB
---------	----	---------	---	------

**VOLKSWAGEN**
**Beetle II (Maggiolino)**

1.2 TSI	77	07/11 →	B	CBZB
---------	----	---------	---	------

**Caddy III**

1.2 TSI	63	09/10 →	B	CBZA
	77	09/10 →	B	CBZB

**84045** NEW **350984045000**



### VOLKSWAGEN

#### Golf V, Plus, Variant

1.2 TSI	63	05/10 → 12/13	B	CBZA
	77	11/09 → 12/13	B	CBZB

#### Golf VI, Variant, Cabrio

1.2 TSI	63	05/10 → 11/12	B	CBZA
	77	11/08 → 11/12	B	CBZB

#### Jetta IV

1.2 TSI	77	02/11 →	B	CBZB
---------	----	---------	---	------

#### Polo VI (6R)

1.2 TSI	66	05/11 → 05/14	B	CBZC
	77	11/09 →	B	CBZB

#### Touran I

1.2 TSI	77	05/10 → 05/15	B	CBZB
---------	----	---------------	---	------

**84046** NEW **350984046000**

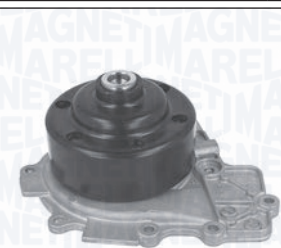

#### PULEGGIA

Diametro Puleggia	Ø105
Altezza Puleggia	37.5
Posizione Attacco	54.5
Diametro Girante	Ø81.8
N° Alette Girante	9
Posizione Girante	3.75



### MERCEDES-BENZ

#### Vito II (W639) - Viano

110 CDI	70	09/10 →	D	OM651.940
113 CDI	100	09/10 →	D	OM651.940
113 CDI 4x4	100	09/10 →	D	OM651.940
116 CDI	120	09/10 →	D	OM651.940
116 CDI 4x4	120	09/10 →	D	OM651.940
CDI 2.0	100	07/10 →	D	OM651.940
CDI 2.0 4-matic	100	07/10 →	D	OM651.940
CDI 2.2	120	07/10 →	D	OM651.940
CDI 2.2 4-matic	120	07/10 →	D	OM651.940

**84047** NEW **350984047000**

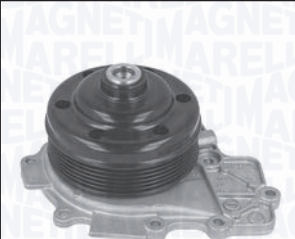

#### PULEGGIA

Diametro Puleggia	Ø110.3
Numero Denti/Gole Puleggia	6
Altezza Puleggia	23
Posizione Attacco	57.4
Diametro Girante	Ø81.8
N° Alette Girante	9
Posizione Girante	3.75



### MERCEDES-BENZ

#### Vito II (W639) - Viano

110 CDI	70	09/10 →	D	OM651.940
113 CDI	100	09/10 →	D	OM651.940
113 CDI 4x4	100	09/10 →	D	OM651.940
116 CDI	120	09/10 →	D	OM651.940
116 CDI 4x4	120	09/10 →	D	OM651.940
CDI 2.0	100	07/10 →	D	OM651.940
CDI 2.0 4-matic	100	07/10 →	D	OM651.940
CDI 2.2	120	07/10 →	D	OM651.940
CDI 2.2 4-matic	120	07/10 →	D	OM651.940

**84048** NEW **350984048000**

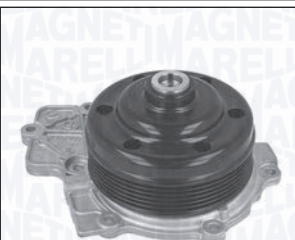

#### PULEGGIA

Diametro Puleggia	Ø110.3
Numero Denti/Gole Puleggia	6
Altezza Puleggia	23
Posizione Attacco	57.4
Diametro Girante	Ø81.8
N° Alette Girante	9
Posizione Girante	3.75



### MERCEDES-BENZ

#### Vito II (W639) - Viano

110 CDI	70	09/10 →	D	OM651.940	Potenziata
113 CDI	100	09/10 →	D	OM651.940	Potenziata
113 CDI 4x4	100	09/10 →	D	OM651.940	Potenziata
116 CDI	120	09/10 →	D	OM651.940	Potenziata
116 CDI 4x4	120	09/10 →	D	OM651.940	Potenziata
CDI 2.0	100	07/10 →	D	OM651.940	Potenziata
CDI 2.0 4-matic	100	07/10 →	D	OM651.940	Potenziata
CDI 2.2	120	07/10 →	D	OM651.940	Potenziata
CDI 2.2 4-matic	120	07/10 →	D	OM651.940	Potenziata

**84049**
**NEW**
**350984049000**

**PULEGGIA**

Diametro Puleggia	Ø90.5
Altezza Puleggia	27
Posizione Attacco	56.5
Diametro Girante	Ø62
N° Alette Girante	6
Posizione Girante	22.6

**KW**

**BMW**
**2 Coupè (F22, F87), Cabrio (F23), Active Tourer (F45), Gran Tourer (F46)**

216 i	75	11/15 →	B	B38A15A
	100	03/15 →	B	B38A15A
218 i	100	09/14 →	B	B38A15A, B38A15MO
220 i	120	11/14 →	B	B48A20A
	141	11/14 →	B	B48A20A
225 i	170	09/14 →	B	B48A20B
225 i xDrive	170	11/14 →	B	B48A20B

**X1 II (F48)**

sDrive 18 i	100	11/15 →	B	B38A15A
sDrive 20 i	141	09/15 →	B	B48A20A
xDrive 20 i	141	09/15 →	B	B48A20A
xDrive 25 i	170	09/15 →	B	B48A20B

**MINI**
**Mini III (F54, F55, F56, F57)**

Cooper	100	07/14 →	B	B38A15A
Cooper S	141	07/14 →	B	B46A20A, B48A20A
Cooper S	141	11/15 →	B	B48A20A
John Cooper Works	170	03/15 →	B	B48A20B
One	75	11/14 →	B	B38A12A
	75	11/15 →	B	B38A15A
One First	55	06/14 →	B	B38A12A

**84050**
**NEW**
**350984050000**

**PULEGGIA**

Diametro Puleggia	Ø90.5
Altezza Puleggia	27
Posizione Attacco	56.5
Diametro Girante	Ø62.5
N° Alette Girante	7
Posizione Girante	22.9

**KW**

**MINI**
**Mini III (F54, F55, F56, F57)**

Cooper D	85	07/14 →	D	B37C15A
One D	70	11/14 →	D	B37C15A

**84051**
**NEW**
**84051**

**PULEGGIA**

Diametro Puleggia	Ø90.5
Altezza Puleggia	27
Posizione Attacco	56.5
Diametro Girante	Ø65
N° Alette Girante	7
Posizione Girante	23.5

**KW**

**BMW**
**2 Coupè (F22, F87), Cabrio (F23), Active Tourer (F45), Gran Tourer (F46)**

218 d	100	03/15 →	D	B47C20A
	100	03/15 →	D	B47C20A
218 d xDrive	100	11/15 →	D	
	110	11/15 →	D	B47C20A
220 d	140	07/15 →	D	B47C20A

**MINI**
**Mini III (F54, F55, F56, F57)**

Cooper SD	125	07/14 →	D	B47C20A
-----------	-----	---------	---	---------

**84052**
**NEW**
**350984052000**

**PULEGGIA**

Diametro Puleggia	Ø56
Numero Denti/Gole Puleggia	19
Altezza Puleggia	33.5
Posizione Attacco	52
Diametro Girante	Ø59.5
N° Alette Girante	8
Posizione Girante	48

**KW**

**SEAT**
**Ibiza IV**

1.9 SDI	47	02/02 → 12/05	D	ASY	→T: 6L3000000
---------	----	---------------	---	-----	---------------

**SKODA**
**Fabia I, Station Wagon, Van**

1.9 SDI	47	12/99 → 03/08	D	ASY	→T: 6Y3X628012
---------	----	---------------	---	-----	----------------

**VOLKSWAGEN**
**Polo V (9N)**

1.9 SDI	47	10/01 → 11/09	D	ASY	→T: 9N2100000
---------	----	---------------	---	-----	---------------

**84053**
**NEW**
**350984053000**

**PULEGGIA**

Diametro Puleggia	Ø113.65
Numero Denti/Gole Puleggia	5
Altezza Puleggia	19.2
Posizione Attacco	64.75
Diametro Girante	Ø54.4
N° Alette Girante	6
Posizione Girante	17.8

**KW**

**OPEL**
**Astra K, Sports Tourer**

1.4	74	06/15 →	B	B14XE	
-----	----	---------	---	-------	--

**Karl**

1.0	52	06/15 →	B	B10XL	
	55	01/15 →	B	B10XE	

1.0 LPG	54	02/15 →		B10XE	
---------	----	---------	--	-------	--

**VAUXHALL**
**ASTRA**

1.4	74	07/15 →	B	B14XE	
-----	----	---------	---	-------	--

**VIVA**

1.0	55	01/15 →	B	B10XE	
-----	----	---------	---	-------	--

**84054**
**NEW**
**350984054000**

**PULEGGIA**

Diametro Puleggia	Ø90
Altezza Puleggia	37
Posizione Attacco	52
Diametro Girante	Ø45
N° Alette Girante	6
Posizione Girante	22.5

**KW**

**CITROËN**
**C 1 II**

1.0 VTI 68	51	04/14 →	B	1KR-FE	
------------	----	---------	---	--------	--

**PEUGEOT**
**108**

1.0 VTI	51	05/14 →	B	1KR-FE	
---------	----	---------	---	--------	--

**TOYOTA**
**Aygo II**

1.0	51	05/14 →	B	1KR-FE	
1.2	60	05/14 →	B	1PP	

**84057**
**NEW**
**350984057000**

**FLANGIA**

Numero Fori Flangia	4
Numero Fori Flangia (Serie 2)	4
Dimensione Fori Flangia	M6×1
Dimensione Fori Flangia (Serie 2)	Ø13
Posizione Attacco	44
Diametro Centraggio	Ø47.2
Diametro Girante	Ø71.5
N° Alette Girante	6
Posizione Girante	26

**KW**

**ALFA ROMEO**
**159, Sportwagon**

3.2 JTS	191	02/08 → 11/11	B	939A.000	
3.2 JTS Q4	191	12/05 → 11/11	B	939A.000	

**Brera**

3.2 JTS	191	03/08 → 06/10	B	939A.000	
3.2 JTS Q4	191	01/06 → 06/10	B	939A.000	

**Spider V**

3.2 JTS	191	03/08 → 06/10	B	939A.000	
3.2 JTS Q4	191	03/06 → 06/10	B	939A.000	

**CADILLAC**
**CTS I**

2.8	158	03/05 → 09/07	B	LP1	
3.6	189	03/05 → 09/07	B	LY7	



**84057** **NEW** **350984057000**

**CADILLAC**
**CTS II, Station Wagon, Coupé**

2.8	155	01/08 →	B	LP1
3.6	229	01/08 →	B	LLT
3.6 AWD	229	01/08 →	B	LLT

**SRX I**

3.6 AWD	190	07/04 → 12/08	B	LY7
---------	-----	---------------	---	-----

**STS**

3.6	189	05/05 → 12/07	B	LY7
-----	-----	---------------	---	-----

**CHEVROLET**
**Captiva**

3.2 4WD	169	06/06 →	B	10HM
---------	-----	---------	---	------

**OPEL**
**Antara**

3.2 V6	167	03/07 →	B	10HM, Z32SEE
--------	-----	---------	---	-----------------

**Insignia, Station Wagon**

2.8 V6 Turbo 4x4	191	07/08 →	B	A28NET
---------------------	-----	---------	---	--------

2.8 V6 Turbo OPC 4x4	239	07/09 →	B	A28NER
----------------------------	-----	---------	---	--------

**Signum**

2.8 V6 Turbo	169	09/05 →	B	Z28NEL
	184	01/06 →	B	Z28NET

**Vectra C, Station Wagon**

2.8 V6 Turbo	169	08/05 →	B	Z28NEL
	184	08/06 →	B	Z28NET
	188	08/05 →	B	Z28NET
	206	08/06 →	B	Z28NET

**SAAB**
**9-3 II, Station Wagon, Cabrio**

2.8 Turbo V6	184	03/05 →	B	LP9
	188	12/07 →	B	B284L
	203	04/08 →	B	B284L
	203	02/09 →	B	B284R
	206	02/09 →	B	B284R

2.8 Turbo V6 XWD	206	05/08 →	B	B284R
---------------------	-----	---------	---	-------

**9-5 II, Station Wagon**

2.8 Turbo V6 XWD	221	05/10 → 01/12	B	A28NER
---------------------	-----	---------------	---	--------

**84057** **NEW** **350984057000**

**VAUXHALL**
**SIGNUM**

2.8 V6 Turbo	169	07/05 → 05/08	B	Z28NEL
--------------	-----	---------------	---	--------

**VECTRA**

2.8 V6 Turbo	169	08/05 → 07/08	B	Z28NEL
	184	08/06 → 07/08	B	Z28NET
	188	08/05 → 07/08	B	Z28NET

**84058** **NEW** **350984058000**

**FLANGIA**

Numero Fori Flangia	3
Dimensione Fori Flangia	M6×1
Posizione Attacco	57
Diametro Centraggio	Ø23.9
Diametro Girante	Ø61.8
N° Alette Girante	7
Posizione Girante	25.7

**HYUNDAI**
**Accent III**

1.5 CRDi GLS	81	11/05 → 11/10	D	D4FA
-----------------	----	---------------	---	------

**Getz**

1.5 CRDi	65	08/05 → 06/09	D	D4FA
1.5 CRDi GLS	75	07/04 → 08/05	D	D4FA
	81	08/05 → 06/09	D	D4FA

**i30 I, Station Wagon**

1.6 CRDi	66	10/07 → 11/11	D	D4FB
	85	10/07 → 11/11	D	D4FB
	94	01/10 → 11/11	D	D4FB

**Matrix**

1.5 CRDi	75	12/04 → 08/10	D	D4FA
1.5 CRDi VGT	81	08/05 → 08/10	D	D4FA

**KIA**
**Cee'd I, Station Wagon**

1.6 CRDi 115	85	12/06 → 12/12	D	D4FB
1.6 CRDi 90	66	12/06 → 12/12	D	D4FB-L

**Cerato I**

1.5 CRDi	75	07/05 →	D	D4FA
1.6 CRDi	85	06/05 →	D	D4FB

**Picanto I**

1.1 CRDi	55	11/05 →	D	D3FA
----------	----	---------	---	------

84058 **NEW** 350984058000



**KIA**

**Pride I, Van**

1.5 CRDi LX	81	03/05 →	D	D4FA	
-------------	----	---------	---	------	--

**Pro Cee'd I**

1.6 CRDi 115	85	02/08 → 09/12	D	D4FB	
--------------	----	---------------	---	------	--

1.6 CRDi 90	66	02/08 → 09/12	D	D4FB-L	
-------------	----	---------------	---	--------	--

**Rio II**

1.5 CRDi	81	03/05 →	D	D4FA	→ 04-2008
----------	----	---------	---	------	-----------

84059 **NEW** 350984059000



**PULEGGIA**  
 Diametro Puleggia Ø59.2  
 Numero Denti/Gole Puleggia 20  
 Altezza Puleggia 30  
 Posizione Attacco 59.4  
 Diametro Girante Ø79.5  
 N° Alette Girante 6  
 Posizione Girante 27.8



**HYUNDAI**

**Grandeur III**

2.2 CRDi	110	06/06 →	D	D4EB	
	114	06/06 →	D	D4EB	

**i30 I, Station Wagon**

2.0 CRDi	100	10/07 → 11/11	D	D4EA	
	103	10/07 → 11/11	D	D4EA	

**Santa Fé I**

2.2 CRDi	110	10/05 → 03/06	D	D4EB	
----------	-----	---------------	---	------	--

**Santa Fé II**

2.2 CRDi	102	03/06 →	D	D4EB	
	114	03/06 →	D	D4EB	
	145	01/09 →	D	D4HB	

2.2 CRDi 4x4	102	03/06 →	D	D4EB	
	110	10/05 → 03/06	D	D4EB	
	114	03/06 →	D	D4EB	
	145	01/09 →	D	D4HB	

2.2 CRDi GLS	110	03/06 →	D	D4EB	
--------------	-----	---------	---	------	--

2.2 CRDi GLS 4x4	110	03/06 →	D	D4EB	
------------------	-----	---------	---	------	--

**Sonata V**

2.0 CRDi	100	02/06 → 12/10	D	D4EA	
	103	02/06 → 12/10	D	D4EA	
	110	03/09 → 12/10	D	D4EA	

84059 **NEW** 350984059000



**HYUNDAI**

**Tucson I**

2.0 CRDi	83	08/04 → 03/10	D	D4EA	01-2006 →
	88	01/07 → 03/10	D	D4EA	
	100	01/06 → 03/10	D	D4EA	
	103	01/06 → 03/10	D	D4EA-V	

2.0 CRDi Trazione integrale	83	08/04 → 03/10	D	D4EA	01-2006 →
	88	01/07 → 03/10	D	D4EA	
	100	01/06 → 03/10	D	D4EA	
	103	01/06 → 03/10	D	D4EA-F, D4EA-V	

2.0 CRDi Trazione integrale	110	01/09 → 03/10	D	D4EA	
	83	08/04 → 03/10	D	D4EA	01-2006 →
	88	01/07 → 03/10	D	D4EA	
	100	01/06 → 03/10	D	D4EA	

**KIA**

**Carens II**

2.0 CRDi	103	11/05 →	D	D4EA	
----------	-----	---------	---	------	--

**Carens III**

2.0 CRDi 115	85	05/07 →	D	D4EA	
--------------	----	---------	---	------	--

2.0 CRDi 135	100	08/09 →	D	D4EA	
--------------	-----	---------	---	------	--

2.0 CRDi 140	103	09/06 →	D	D4EA	
--------------	-----	---------	---	------	--

**Cee'd I, Station Wagon**

2.0 CRDi	100	06/07 → 12/12	D	D4EA	
----------	-----	---------------	---	------	--

**Cerato I**

2.0 CRDi	83	04/04 →	D	D4EA	06-2005 →
----------	----	---------	---	------	-----------

**Magentis II**

2.0 CRDi	100	11/05 → 12/08	D	D4EA	
	103	04/06 →	D	D4EA	
	110	04/06 →	D	D4EA	

**Pro Cee'd I**

2.0 CRDi 140	103	02/08 → 09/12	D	D4EA-F	
--------------	-----	---------------	---	--------	--

**Sportage II**

2.0 CRDi	83	02/05 →	D	D4EA	
	100	01/06 →	D	D4EA	
	103	01/06 →	D	D4EA-V	
	110	09/08 →	D	D4EA	

2.0 CRDi 4WD	83	09/04 →	D	D4EA	
	100	01/06 →	D	D4EA	
	103	01/06 →	D	D4EA-F, D4EA-V	
	110	09/08 →	D	D4EA	

**84060**
**NEW**
**350984060000**

**PULEGGIA**

Diametro Puleggia	Ø103.3
Altezza Puleggia	26
Posizione Attacco	55.8
Diametro Girante	Ø58.6
N° Alette Girante	6
Posizione Girante	10.6

**KW**

**MAZDA**
**2 II, Saloon**

1.3	55	10/07 → 06/15	B	ZJ-VE
	63	10/07 → 06/15	B	ZJ-VE
1.3 BiFuel	55	05/11 → 11/14	BF	ZJ46
	62	05/11 → 11/14	BF	ZJ46
1.3 MZR	62	01/10 → 06/15	B	ZJ-VE
1.5	76	10/07 → 06/15	B	ZY-DE, ZY-VE
1.5 MZR	75	06/11 → 06/15	B	ZY05, ZY66

**3 I, Saloon**

1.4	62	10/03 → 06/09	B	ZJ-VE
	59	02/04 → 06/09	B	FXJA
1.6	77	10/03 → 06/09	B	B6ZE
	77	02/04 → 06/09	B	Z6

**3 II, Saloon**

1.6 MZR	77	06/09 →	B	Z6
---------	----	---------	---	----

**3 III, Saloon**

1.6	77	09/13 →	B	Z6Y1
	77	09/13 →	B	Z6Y1, Z6Y3

**84061**
**NEW**
**350984061000**

**PULEGGIA**

Diametro Puleggia	Ø97
Altezza Puleggia	25.5
Posizione Attacco	71.5
Diametro Girante	Ø47
N° Alette Girante	8
Posizione Girante	19.5

**KW**

**NISSAN**
**Primeria III, Hatchback, Station Wagon**

2.0	103	03/02 →	B	QR20DE
-----	-----	---------	---	--------

**84061**
**NEW**
**350984061000**

**KW**

**NISSAN**
**X-Trail I**

2.0	103	07/01 → 01/13	B	QR20DE
	110	09/01 → 01/13	B	QR20DE
2.0 4x4	103	07/01 → 01/13	B	QR20DE
	110	09/01 → 01/13	B	QR20DE
2.5 4x4	206	06/01 → 01/13	B	SR20VET
	121	09/02 → 01/13	B	QR25DE
	132	11/02 → 01/13	B	QR25DE

**X-Trail II**

2.5 4x4	124	06/07 → 11/13	B	QR25DE
---------	-----	---------------	---	--------

**RENAULT**
**Koleos**

2.5	126	09/08 →	B	2TR700, 2TR702, 2TR703
2.5 4x4	126	09/08 →	B	2TR700, 2TR702, 2TR703

**84062**
**NEW**
**350984062000**

**PULEGGIA**

Diametro Puleggia	Ø43.4
Numero Denti/Gole Puleggia	28
Altezza Puleggia	11
Posizione Attacco	34.4
Diametro Girante	Ø63
N° Alette Girante	6
Posizione Girante	18.35

**KW**

**AUDI**
**A1, Sportback**

1.4 TFSI	92	11/14 →	B	CZCA, CZDB
	103	04/12 →	B	CPTA
	110	11/14 →	B	CZEA

**A3 III, Sportback, Cabriolet**

1.2 TFSI	77	02/13 →	B	CJZA
	81	05/14 →	B	CYVB
1.4 TFSI	85	02/16 →	B	CZCC
	90	04/12 →	B	CMBA, CXSA
	92	05/14 →	B	CXSB, CZCA
	103	03/13 →	B	CPTA
	110	05/14 →	B	CZEA
1.4 TFSI e-tron	110	05/14 →		CUKB, CXUA

**84062**
**NEW**
**350984062000**

**KW**

**AUDI**
**A3 III, Sportback, Cabriolet**

1.4 TFSI g-tron	81	11/13 →		CPWA
-----------------	----	---------	--	------

**A4 V, Avant, Allroad**

1.4 TFSI	110	08/15 →	B	CVNA
----------	-----	---------	---	------

**Q3**

1.4 TFSI	110	10/13 →	B	CHPB, CZDA, CZEA
----------	-----	---------	---	------------------

**SEAT**
**Alhambra II**

1.4 TSI	110	05/15 →	B	CZDA
---------	-----	---------	---	------

**Ibiza V**

1.2 TSI	66	05/15 →	B	CJZC
	81	09/15 →	B	CJZD
1.4 TSI	103	10/13 →	B	CPTA
	110	11/15 →	B	CZEA

**Leon III**

1.0 TSI	85	05/15 →	B	CHZD
1.2 TSI	63	12/12 →	B	CJZB, CYVA
	77	01/13 →	B	CJZA
	81	04/14 →	B	CYVB
1.4 TGI	81	02/13 →		CPWA
1.4 TSI	90	11/12 →	B	CMBA, CXSA
	92	05/14 →	B	CZCA
	103	09/12 →	B	CHPA, CPTA
	110	05/14 →	B	CZEA

**SKODA**
**Fabia III, Station Wagon**

1.2 TSI	66	08/14 →	B	CJZC
	81	08/14 →	B	CJZD

**Octavia III, Station Wagon**

1.2 TSI	63	11/12 →	B	CJZB
	77	11/12 →	B	CJZA
	81	05/15 →	B	CYVB
1.4 TSI	103	11/12 →	B	CHPA
	110	08/14 →	B	CHPB, CZDA
1.4 TSI G-TEC	81	11/13 →		CPWA
1.6	81	01/14 →	B	CWVA

**Rapid II**

1.4 TSI	92	05/15 →	B	CZCA
---------	----	---------	---	------

**Superb**

1.4 TSI	92	03/15 →	B	CZCA
	110	03/15 →	B	CZDA, CZEA
1.4 TSI 4x4	110	03/15 →	B	CZDA, CZEA

**84062**
**NEW**
**350984062000**

**KW**

**SKODA**
**Yeti**

1.2 TSI	81	05/15 →	B	CYVB
1.4 TSI	92	05/15 →	B	CZCA
1.4 TSI 4x4	110	05/15 →	B	CZDA
1.6	81	04/14 →	B	CWVA

**VOLKSWAGEN**
**Golf VI, Variant, Cabrio**

1.2 TSI 16V	77	11/13 →	B	CYVD
1.4 TSI	92	11/13 →	B	CXSB, CZCA
	110	11/13 →	B	CHPB, CZDA

**Golf VII, Variant, Cabrio, AllTrack**

1.0 TSI	85	05/15 →	B	CHZD
1.2 TSI	63	08/12 →	B	CJZB, CYVA
	63	05/14 →	B	CYVA
	77	11/12 →	B	CJZA
1.4 GTE Hybrid	110	05/14 →		CUKB
		06/13 →		CPWA, CZBA
1.4 TSI	90	11/12 →	B	CMBA, CPVA, CXSA
		05/13 →	B	CPVA, CXSA
		04/14 →	B	CPVB, CZCA
		05/13 →	B	CHPA
		11/12 →	B	CHPA, CPTA
		05/14 →	B	CHPB, CZDA
		05/14 →	B	CHPB, CZDA, CZEA
		02/14 →	B	CZDA
1.4 TSI MultiFuel	92	04/13 →		CPVA
04/14 →			CPVB	
1.6	81	05/14 →	B	CWVA

**Passat VIII, Variant, AllTrack**

1.4 GTE Hybrid	115	06/15 →		CUKC
1.4 TSI	92	11/14 →	B	CZCA
	110	11/14 →	B	CZDA, CZEA
1.4 TSI 4motion	110	02/15 →	B	CZEA

**Polo VI (6R)**

1.0 TSI	70	11/14 →	B	CHZB
1.2 TSI	81	01/14 →	B	CJZD
1.2 TSI 16V	66	02/14 →	B	CJZC

**84062** NEW **350984062000**

**VOLKSWAGEN**
**Polo VI (6R)**

1.4 TSI	103	10/12 →	B	CPTA
	110	05/14 →	B	CZEA
1.6	81	07/14 →	B	CWVA

**Sharan II**

1.4 TSI	110	05/15 →	B	CZDA
---------	-----	---------	---	------

**Tiguan I**

1.4 TSI	92	05/15 →	B	CZDB
	110	05/15 →	B	CZDA

**Touran II**

1.2 TSI	81	05/15 →	B	CYVB
1.4 TSI	110	05/15 →	B	CZDA

**84063** NEW **350984063000**

**FLANGIA**

Numero Fori Flangia	3
Dimensione Fori Flangia	M6X1
Posizione Attacco	57
Diametro Centraggio	Ø23.8
Diametro Girante	Ø62.4
N° Alette Girante	7
Posizione Girante	25.65

**HYUNDAI**
**i20 I**

1.1 CRDi	55	03/12 →	D	D3FA
1.6 CRDi	94	01/09 →	D	D4FB

**i30 II, Station Wagon, Coupé**

1.4 CRDi	66	12/11 →	D	D4FC
	81	12/11 →	D	D4FB
1.6 CRDi	94	12/11 →	D	D4FB
	94	06/12 →	D	D4FB-5P

**KIA**
**Cee'd II, Station Wagon**

1.4 CRDi 90	66	05/12 →	D	D4FC
1.6 CRDi 110	81	05/12 →	D	D4FB
		05/12 →	D	D4FB
1.6 CRDi 128	94	05/12 →	D	D4FB

**Pro Cee'd II**

1.4 CRDi 90	66	03/13 →	D	D4FC
1.6 CRDi 110	81	03/13 →	D	D4FB

**84063** NEW **350984063000**

**KIA**
**Pro Cee'd II**

1.6 CRDi 128	94	03/13 →	D	D4FB
--------------	----	---------	---	------

**Rio II**

1.5 CRDi	65	06/08 →	D	D4FA
----------	----	---------	---	------

**Rio III**

1.1 CRDi	55	09/11 →	D	D3FA
1.4 CRDi	66	09/11 →	D	D4FC

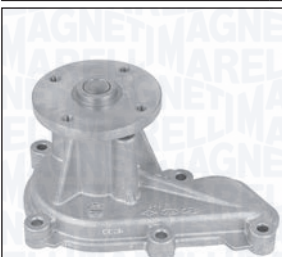
**84064** NEW **350984064000**

**FLANGIA**

Numero Fori Flangia	4
Dimensione Fori Flangia	M6X1
Posizione Attacco	78
Diametro Centraggio	Ø24
Diametro Girante	Ø57.2
N° Alette Girante	6
Posizione Girante	7.2

**HYUNDAI**
**Elantra III**

1.8	110	09/10 →	B	G4NB-B
-----	-----	---------	---	--------

**i40**

2.0 GDI	130	07/11 →	B	G4NC
	131	03/12 →	B	G4NC

**KIA**
**Carens IV**

2.0 GDi	122	03/13 →	B	G4NC
	130	03/13 →	B	G4NC

**Sportage III**

2.0 CVVT	120	07/10 →	B	G4KD
	122	07/10 →	B	G4KD
2.0 CVVT AWD	120	07/10 →	B	G4KD
2.0 GDI	122	02/14 →	B	G4NC
2.0 GDI AWD	122	02/14 →	B	G4NC

**84065**
**NEW**
**350984065000**

**FLANGIA**

Numero Fori Flangia	3
Dimensione Fori Flangia	M6X1
Posizione Attacco	66
Diametro Centraggio	Ø28
Diametro Girante	Ø50
N° Alette Girante	7
Posizione Girante	10.60

**KW**

**HONDA**
**Civic IX, Hatchback, Coupé**

1.4 i-VTEC	73	02/12 →	B	L13Z4
------------	----	---------	---	-------

**Civic VIII, Hatchback, Coupé**

1.4	73	10/08 →	B	L13Z1
-----	----	---------	---	-------

**84066**
**NEW**
**350984066000**

**PULEGGIA**

Diametro Puleggia	Ø66
Numero Denti/Gole Puleggia	3
Altezza Puleggia	12.3
Posizione Attacco	39.95
Diametro Girante	Ø49.8
N° Alette Girante	6
Posizione Girante	22.34

**KW**

**CITROËN**
**C 1 II**

1.2 VTi 82	60	04/14 →	B	HMT (EB2D)
------------	----	---------	---	------------

**C 3 II, Picasso**

1.0 VTi 68	50	08/12 →	B	ZMZ (EB0)
------------	----	---------	---	-----------

1.2 THP 110	81	10/14 →	B	HNZ (EB2DT)
-------------	----	---------	---	-------------

1.2 VTi 82	60	06/12 →	B	HMZ (EB2F)
------------	----	---------	---	------------

**C 4 Cactus**

1.2 THP 110	81	09/14 →	B	HNZ (EB2DT)
-------------	----	---------	---	-------------

1.2 VTi 75	55	09/14 →	B	HMU (EB2D)
------------	----	---------	---	------------

1.2 VTi 82	60	09/14 →	B	HMZ (EB2F)
------------	----	---------	---	------------

**C 4 II, Picasso, Grand Picasso**

1.2 THP 110	81	02/15 →	B	HNZ (EB2DT)
-------------	----	---------	---	-------------

1.2 THP 130	96	04/14 →	B	HNY (EB2DTS)
-------------	----	---------	---	--------------

**C-Elysee**

1.2 VTi 72	53	11/12 →	B	HMY (EB2M)
------------	----	---------	---	------------

1.2 VTi 82	60	12/14 →	B	
------------	----	---------	---	--

**DS 3, Cabrio**

1.2 THP 110	81	10/14 → 03/15	B	HNZ (EB2DT)
-------------	----	---------------	---	-------------

1.2 VTi 82	60	01/13 → 03/15	B	HMZ (EB2F)
------------	----	---------------	---	------------

**84066**
**NEW**
**350984066000**

**KW**

**CITROËN**
**DS 4**

1.2 THP 130	96	07/14 → 07/15	B	HNY (EB2DTS)
-------------	----	---------------	---	--------------

**DS**
**DS 3**

1.2 VTi 110	81	04/15 →	B	
-------------	----	---------	---	--

1.2 VTi 82	60	04/15 →	B	
------------	----	---------	---	--

**DS 4 / DS 4 CROSSBACK**

1.2 VTi	96	07/15 →	B	
---------	----	---------	---	--

**PEUGEOT**
**108**

1.2	60	05/14 →	B	HMT (EB2D)
-----	----	---------	---	------------

**208**

1.0	50	03/12 →	B	ZMZ (EB0)
-----	----	---------	---	-----------

1.2	60	03/12 →	B	HMZ (EB2F)
-----	----	---------	---	------------

1.2 THP	81	01/13 →	B	HNZ (EB2DT)
---------	----	---------	---	-------------

**301**

1.2 VTi 72	53	11/12 →	B	HMY (EB2M)
------------	----	---------	---	------------

**308 II Station Wagon**

1.2 THP 110	81	11/13 →	B	HNZ (EB2DT)
-------------	----	---------	---	-------------

1.2 THP 130	96	11/13 →	B	HNY (EB2DTS)
-------------	----	---------	---	--------------

1.2 VTi 72	60	09/13 →	B	HMZ (EB2F)
------------	----	---------	---	------------

**2008**

1.2 THP 110	81	01/15 →	B	HNZ (EB2DT)
-------------	----	---------	---	-------------

1.2 THP 130	96	01/15 →	B	HNY (EB2DTS)
-------------	----	---------	---	--------------

1.2 VTi	60	03/13 →	B	HMZ (EB2F)
---------	----	---------	---	------------

**3008**

1.2	96	01/15 →	B	HNY (EB2DTS)
-----	----	---------	---	--------------

**5008**

1.2	96	01/15 →	B	HNY (EB2DTS)
-----	----	---------	---	--------------

**Tavole di comparazione OES**  
**OES cross reference guide**  
**Gegenüberstellung OES**  
**Table de correspondance OES**  
**Tabla de equivalencias OES**  
**Tabela de equivalências OES**  
**Πίνακας αντιστοιχιών OES**  
**Tabela porównawcza OES**  
**Кросс-таблица с OES номерами**  
**OES çapraz referans tablosu**

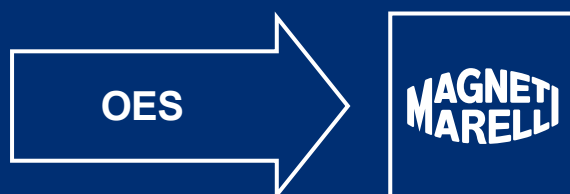





<b>OES</b>	<b>MAGNETI MARELLI</b>
------------	------------------------

<b>ACURA</b>	
19200P72003	<b>81839</b>
19200P72013	<b>81839</b>
19200P72A01	<b>81839</b>
19200POA003	<b>81708</b>

<b>ALFA ROMEO</b>	
-------------------	--

532912	<b>11706T</b>
547815	<b>11706T</b>
4714636	<b>81334</b>
4754850	<b>81334</b>
4764761	<b>81334</b>
5896818	<b>81464</b>
5896819	<b>81464</b>
5973319	<b>81443</b>
7072641	<b>81302</b>
7301300	<b>81492</b>
7303009	<b>81334</b>
7303030	<b>81492</b>
7629033	<b>81464</b>
7631379	<b>81464</b>
7693570	<b>81464</b>
7693570	<b>81326</b>
7696226	<b>81464</b>
7708187	<b>81322</b>
7747388	<b>81322</b>
46432248	<b>81352</b>
46515970	<b>81352</b>
46515972	<b>81352</b>
46520401	<b>81369</b>
46804051	<b>81872</b>
46804051	<b>81872</b>
55184081	<b>81369</b>
55198357	<b>81355</b>
55198358	<b>81355</b>
55198547	<b>81369</b>
55204538	<b>82070</b>
55209993	<b>81872</b>
55209993	<b>81872</b>
55221397	<b>82070</b>
55268277	<b>82070</b>
55268918	<b>81872</b>
55271994	<b>82070</b>
60504407	<b>11706T</b>
60513151	<b>19532/E</b>
60518083	<b>11701T</b>

<b>OES</b>	<b>MAGNETI MARELLI</b>
------------	------------------------

<b>ALFA ROMEO</b>	
-------------------	--

60523035	<b>11701T</b>
60534334	<b>11707</b>
60534335	<b>11707</b>
60534336	<b>11707</b>
60534758	<b>11701T</b>
60536055	<b>11706T</b>
60555345	<b>11707</b>
60555347	<b>19532/E</b>
60555348	<b>19532/E</b>
60561800	<b>19532/E</b>
60562567	<b>81302</b>
60563626	<b>11701T</b>
60564004	<b>81302</b>
60564048	<b>19532/E</b>
60565727	<b>11706T</b>
60585358	<b>11708T</b>
60585362	<b>11708T</b>
60586222	<b>81331</b>
60586467	<b>11706T</b>
60597487	<b>11708T</b>
60604181	<b>81355</b>
60608898	<b>81348</b>
60611459	<b>11706T</b>
60614390	<b>11706T</b>
60622295	<b>11706T</b>
60624553	<b>11706T</b>
60630271	<b>81355</b>
60668487	<b>81355</b>
60700439	<b>11707</b>
60703264	<b>11707</b>
60778982	<b>81362</b>
60778983	<b>81362</b>
60800169	<b>81443</b>
60808116	<b>19532/E</b>
60808756	<b>81464</b>
60809209	<b>81322</b>
60810426	<b>81322</b>
60811328	<b>81331</b>
60812263	<b>81347</b>
60812263	<b>81363</b>
60813207	<b>81355</b>
60814609	<b>81352</b>
60815559	<b>81352</b>
60816018	<b>81355</b>
71713045	<b>19532/E</b>

<b>OES</b>	<b>MAGNETI MARELLI</b>
------------	------------------------

<b>ALFA ROMEO</b>	
-------------------	--

71719676	<b>81322</b>
71737965	<b>81322</b>
71737989	<b>19532/E</b>
71739401	<b>81812</b>
71739779	<b>82083</b>
71741078	<b>84057</b>
71747983	<b>84057</b>
71751273	<b>81812</b>
71777350	<b>82070</b>
99440726	<b>81334</b>
113050702400	<b>11701T</b>
113050702401	<b>11701T</b>
116460702400	<b>11707</b>
117010702400	<b>11701T</b>
119000702400	<b>11707</b>
119000702402	<b>11707</b>
195150702400	<b>11707</b>
195150702401	<b>11707</b>
195320702402	<b>19532/E</b>
195360702400	<b>11701T</b>

<b>AUDI</b>	
-------------	--

022121011	<b>81866</b>
026121005	<b>81522</b>
026121010	<b>82080</b>
026121010	<b>82080</b>
028121004	<b>81528</b>
034121004	<b>81683</b>
037121010	<b>82080</b>
037121010	<b>82080</b>
038121011	<b>81706</b>
045121011	<b>81791</b>
050121010	<b>81529</b>
052121004	<b>81520</b>
052121005	<b>81520</b>
052121019	<b>81520</b>
054121004	<b>81700</b>
055121010	<b>82001</b>
056121011	<b>82001</b>
068121005	<b>81521</b>
068121010	<b>82001</b>
069121004	<b>81593</b>
074121004	<b>81701</b>
078121006	<b>81842</b>
022121011A	<b>81866</b>

OES	MAGNETI MARELLI
<b>AUDI</b>	
022121011L	81866
022121011V	81866
022121011X	81866
026121005A	81522
026121005C	81522
026121005E	81522
026121005F	81526
026121005G	81522
026121005H	81522
026121005K	81526
026121010A	82001
026121010AV	82001
026121010AX	82001
026121010C	82080
026121010C	82080
026121010CV	82080
026121010CV	82080
026121010CX	82080
026121010CX	82080
026121010D	82001
026121010DV	82001
026121010DX	82001
026121010E	82080
026121010E	82080
026121010F	82080
026121010F	82080
026121010FV	82080
026121010FV	82080
026121010FX	82080
026121010FX	82080
026121010V	82080
026121010V	82080
026121010X	82080
026121010X	82080
028121004V	81528
028121004X	81528
034121004A	81683
034121004B	81700
034121004V	81683
034121004X	81683
034121005D	81683
036121005E	81777
036121005EV	81777
036121005EX	81777
036121005F	81840

OES	MAGNETI MARELLI
<b>AUDI</b>	
036121005G	81840
036121005GX	81840
036121005P	81840
036121005Q	81777
036121005QX	81777
036121005S	81777
036121005SV	81777
036121005SX	81777
036121008G	81840
036121008GX	81840
036121008K	81777
036121008L	81777
036121008M	81777
036121008MX	81777
037121010A	82080
037121010A	82080
037121010AV	82080
037121010AV	82080
037121010AX	82080
037121010AX	82080
037121010BX	82080
037121010BX	82080
037121010C	82080
037121010C	82080
038121011A	81706
038121011AV	81706
038121011AX	81706
038121011C	81816
038121011CX	81816
038121011D	81816
038121011G	84011
038121011GX	84011
038121011H	84011
038121011HX	84011
038121011J	84011
038121011JX	84011
038121011K	84011
038121011KX	84011
03C121005B	81865
03C121005C	81865
03C121005D	81865
03C121005DX	81865
03C121005K	81865
03C121005N	82097
03C121005NX	82097

OES	MAGNETI MARELLI
<b>AUDI</b>	
03C121005R	82097
03C121005RX	82097
03C121005S	81865
03C121008B	82097
03C121008C	81865
03C121008CX	81865
03C121008E	82097
03C121008F	81865
03C121008FX	81865
03C121008J	81865
03C121008JX	81865
03F121004A	84045
03F121004B	84045
03F121004D	84045
03F121005	84045
03L121011	84001
03L121011G	84011
03L121011GX	84011
03L121011H	84001
03L121011J	84001
03L121011P	84001
045121011B	81791
045121011BX	81791
045121011F	84010
045121011FX	84010
045121011H	84010
045121011HX	84010
046121004D	81701
046121004DV	81701
046121004DX	81701
04C121600K	84062
04E121600AD	84062
04E121600AG	84062
04E121600AL	84062
04E121600AQ	84062
04E121600AR	84062
04E121600D	84062
04E121600H	84062
04E121600P	84062
050121010A	81529
050121010AV	81529
050121010AX	81529
050121010C	81529
050121010V	81529
050121010X	81529

<b>OES</b>	<b>MAGNETI MARELLI</b>
------------	------------------------

<b>AUDI</b>	
052121004AV	<b>81520</b>
052121004AX	<b>81520</b>
052121004V	<b>81520</b>
052121004X	<b>81520</b>
052121005A	<b>81520</b>
052121005AX	<b>81520</b>
054121004A	<b>81700</b>
054121004AV	<b>81700</b>
054121004AX	<b>81700</b>
054121004V	<b>81700</b>
054121004X	<b>81700</b>
055121010X	<b>82001</b>
056121005A	<b>81521</b>
056121013A	<b>82001</b>
057121004C	<b>82041</b>
057121004CX	<b>82041</b>
057121011E	<b>82046</b>
059121004B	<b>81705</b>
059121004C	<b>81705</b>
059121004CX	<b>81705</b>
059121004D	<b>81705</b>
059121004E	<b>81705</b>
059121004EV	<b>81705</b>
059121004EX	<b>81705</b>
059121005T	<b>84021</b>
059121005TX	<b>84021</b>
059121008A	<b>84021</b>
059121008J	<b>84021</b>
059121008JX	<b>84021</b>
068121005A	<b>81522</b>
068121005B	<b>81521</b>
068121005C	<b>81521</b>
068121005X	<b>81521</b>
068121010A	<b>82080</b>
068121010A	<b>82080</b>
068121010AX	<b>82080</b>
068121010AX	<b>82080</b>
069121004V	<b>81593</b>
069121004X	<b>81593</b>
069121005D	<b>81593</b>
06A121011C	<b>81703</b>
06A121011E	<b>81703</b>
06A121011EV	<b>81703</b>
06A121011EX	<b>81703</b>
06A121011F	<b>81703</b>

<b>OES</b>	<b>MAGNETI MARELLI</b>
------------	------------------------

<b>AUDI</b>	
06A121011G	<b>81703</b>
06A121011H	<b>81703</b>
06A121011HV	<b>81703</b>
06A121011HX	<b>81703</b>
06A121011L	<b>81703</b>
06A121011LV	<b>81703</b>
06A121011LX	<b>81703</b>
06A121011T	<b>81703</b>
06A121011TX	<b>81703</b>
06A121012	<b>81703</b>
06A121012G	<b>81703</b>
06A121012X	<b>81703</b>
06B121011	<b>81702</b>
06B121011A	<b>81702</b>
06B121011B	<b>81702</b>
06B121011BV	<b>81702</b>
06B121011BX	<b>81702</b>
06B121011C	<b>81702</b>
06B121011CV	<b>81702</b>
06B121011CX	<b>81702</b>
06B121011E	<b>81702</b>
06B121011EV	<b>81702</b>
06B121011EX	<b>81702</b>
06B121011H	<b>81702</b>
06B121011L	<b>81702</b>
06B121011LX	<b>81702</b>
06B121011M	<b>81702</b>
06B121011N	<b>81702</b>
06B121011NX	<b>81702</b>
06B121011Q	<b>81702</b>
06C121004C	<b>81819</b>
06C121004G	<b>81819</b>
06C121004H	<b>81819</b>
06C121004HX	<b>81819</b>
06C21004G	<b>81819</b>
06E121005D	<b>82015</b>
06E121005F	<b>82015</b>
06E121005N	<b>82015</b>
06E121018A	<b>82015</b>
06E121018AX	<b>82015</b>
06F121011	<b>82025</b>
06F121011X	<b>82025</b>
06H121026AB	<b>84016</b>
06H121026AF	<b>84016</b>
06H121026AG	<b>84016</b>

<b>OES</b>	<b>MAGNETI MARELLI</b>
------------	------------------------

<b>AUDI</b>	
06H121026B	<b>84016</b>
06H121026B	<b>84016</b>
06H121026BA	<b>84016</b>
06H121026BE	<b>84016</b>
06H121026BF	<b>84016</b>
06H121026BP	<b>84016</b>
06H121026CC	<b>84016</b>
06H121026CP	<b>84016</b>
06H121026DD	<b>84016</b>
06H121026N	<b>84016</b>
06J121026A	<b>84016</b>
06J121026AG	<b>84016</b>
06J121026F	<b>84016</b>
06J121026G	<b>84016</b>
06K121011	<b>84037</b>
06L121005A	<b>84037</b>
06L121012	<b>84037</b>
06L121012A	<b>84037</b>
074121004A	<b>81701</b>
074121004AV	<b>81701</b>
074121004AX	<b>81701</b>
074121004BX	<b>81701</b>
074121004N	<b>81701</b>
074121004NX	<b>81701</b>
074121004V	<b>81701</b>
074121004X	<b>81701</b>
074121005MV	<b>81701</b>
074121005N	<b>81701</b>
077121004M	<b>82081</b>
077121004MX	<b>82081</b>
077121004N	<b>82081</b>
077121004P	<b>82081</b>
077121004PX	<b>82081</b>
078121004H	<b>81842</b>
078121004HX	<b>81842</b>
078121004J	<b>81842</b>
078121004JV	<b>81842</b>
078121004JX	<b>81842</b>
078121004L	<b>81842</b>
078121004Q	<b>81842</b>
078121004QX	<b>81842</b>
078121004R	<b>81842</b>
078121006A	<b>81842</b>
078121006X	<b>81842</b>
079121011F	<b>82046</b>

<b>OES</b>	<b>MAGNETI MARELLI</b>
------------	------------------------

**AUDI**

079121011H	<b>82046</b>
079121012B	<b>82046</b>

**BEDFORD**

1334004	<b>81543</b>
1334008	<b>81606</b>
1334011	<b>81681</b>
1334014	<b>81605</b>
1334023	<b>81543</b>
1334024	<b>81681</b>
1334025	<b>81549</b>
1334027	<b>81544</b>
1334041	<b>81550</b>
1334050	<b>81550</b>
1334053	<b>81550</b>
1334070	<b>81543</b>
1334071	<b>81544</b>
1334098	<b>81549</b>
1334119	<b>81550</b>
1334137	<b>81550</b>
9192370	<b>81550</b>
90076952	<b>81543</b>
90091035	<b>81544</b>
90144227	<b>81549</b>
90183273	<b>81543</b>
90220568	<b>81606</b>
90234200	<b>81681</b>
90272361	<b>81606</b>
90273361	<b>81606</b>
90284813	<b>81605</b>
90284913	<b>81605</b>
90295078	<b>81605</b>
90325660	<b>81549</b>
90325661	<b>81681</b>
90349239	<b>81549</b>
90349241	<b>81543</b>
90409912	<b>81544</b>
90443549	<b>81550</b>
90444311	<b>81550</b>
96351969	<b>81549</b>
R1160012	<b>81549</b>
R1160024	<b>81605</b>
R1160032	<b>81550</b>

<b>OES</b>	<b>MAGNETI MARELLI</b>
------------	------------------------

**BMW**

11510007039	<b>81589</b>
11510393338	<b>81590</b>
11510393731	<b>81793</b>
11511271435	<b>81586</b>
11511271436	<b>81618</b>
11511272613	<b>81618</b>
11511272616	<b>81586</b>
11511274583	<b>81584</b>
11511274584	<b>81584</b>
11511284694	<b>81618</b>
11511286355	<b>81584</b>
11511286358	<b>81584</b>
11511286417	<b>81618</b>
11511287367	<b>81618</b>
11511312129	<b>81618</b>
11511312539	<b>81618</b>
11511433712	<b>81588</b>
11511433828	<b>81588</b>
11511706564	<b>81586</b>
11511706588	<b>81586</b>
11511706624	<b>81586</b>
11511707190	<b>81618</b>
11511707191	<b>81618</b>
11511707192	<b>81618</b>
11511711492	<b>81586</b>
11511715292	<b>81587</b>
11511719836	<b>81616</b>
11511720292	<b>81618</b>
11511720609	<b>81616</b>
11511720892	<b>81618</b>
11511720893	<b>81618</b>
11511721337	<b>81587</b>
11511721477	<b>81584</b>
11511721872	<b>81590</b>
11511722536	<b>81588</b>
11511727123	<b>81589</b>
11511727468	<b>81590</b>
11511730414	<b>81588</b>
11511734269	<b>81589</b>
11511734595	<b>81590</b>
11511734602	<b>81590</b>
11511740241	<b>81588</b>
11511744243	<b>81588</b>
11512242176	<b>81617</b>
11512242677	<b>81617</b>

<b>OES</b>	<b>MAGNETI MARELLI</b>
------------	------------------------

**BMW**

11512243003	<b>81597</b>
11512244333	<b>81597</b>
11512245687	<b>81597</b>
11512247552	<b>81793</b>
11512248996	<b>81796</b>
11512354055	<b>81795</b>
11517503884	<b>81588</b>
11517504040	<b>81588</b>
11517511220	<b>82010</b>
11517511221	<b>82010</b>
11517515778	<b>82010</b>
11517527799	<b>81588</b>
11517527910	<b>81588</b>
11517550484	<b>82032</b>
11517786192	<b>81795</b>
11517786736	<b>81794</b>
11517788305	<b>82040</b>
11517788305	<b>82040</b>
11517788306	<b>82034</b>
11517790135	<b>82040</b>
11517790322	<b>82040</b>
11517790322	<b>82040</b>
11517790471	<b>82040</b>
11517790472	<b>82040</b>
11517791833	<b>82040</b>
11517791834	<b>82040</b>
11517801609	<b>82040</b>
11517805808	<b>82040</b>
11517805810	<b>82040</b>
11517807311	<b>84000</b>
11517823428	<b>84023</b>
11517823429	<b>84022</b>
11518512269	<b>84023</b>
11518512497	<b>84023</b>
11518516435	<b>84023</b>
11518577893	<b>84051</b>
11518586721	<b>84051</b>
11518623574	<b>84049</b>
11519058996	<b>81586</b>
11519068606	<b>81597</b>
11519069529	<b>81597</b>
11519070755	<b>81584</b>
11519070759	<b>81616</b>
11519070761	<b>81618</b>

<b>OES</b>	<b>MAGNETI MARELLI</b>
------------	------------------------

<b>CADILLAC</b>	
-----------------	--

12566029	<b>84057</b>
----------	--------------

<b>CHEVROLET</b>	
------------------	--

12624936	<b>81812</b>
24409355	<b>81550</b>
25183429	<b>84014</b>
92065969	<b>81550</b>
92226211	<b>81550</b>
96440224	<b>84014</b>
96518977	<b>81783</b>
96563958	<b>81783</b>
96666219	<b>81783</b>
96872702	<b>81782</b>
96930074	<b>81782</b>

<b>CHRYSLER</b>	
-----------------	--

4667660	<b>81733</b>
4720429	<b>81302</b>
4864566	<b>81362</b>
55204538	<b>82070</b>
55221397	<b>82070</b>
5066809AA	<b>84033</b>
5066809AB	<b>84033</b>
5175580AA	<b>82058</b>
68000693AB	<b>84011</b>
68027359AA	<b>84043</b>
68271384AA	<b>82070</b>

<b>CITROËN</b>	
----------------	--

1201E0	<b>81353</b>
1201E1	<b>82089</b>
1201E1	<b>84038</b>
1201E1	<b>82089</b>
1201E1	<b>81799</b>
1201E3	<b>81556</b>
1201E4	<b>81513</b>
1201E5	<b>81753</b>
1201E7	<b>82089</b>
1201E7	<b>84038</b>
1201E7	<b>82089</b>
1201E7	<b>81799</b>
1201E8	<b>81800</b>
1201A1	<b>81711</b>
1201A2	<b>81753</b>
1201A3	<b>81752</b>

<b>OES</b>	<b>MAGNETI MARELLI</b>
------------	------------------------

<b>CITROËN</b>	
----------------	--

1201A4	<b>81642</b>
1201A5	<b>81712</b>
1201A6	<b>81844</b>
1201A7	<b>81353</b>
1201A8	<b>81642</b>
1201C4	<b>81713</b>
1201C5	<b>81353</b>
1201C6	<b>81353</b>
1201C7	<b>81844</b>
1201C9	<b>81316</b>
1201F2	<b>82042</b>
1201F4	<b>82089</b>
1201F4	<b>84038</b>
1201F4	<b>82089</b>
1201F4	<b>81799</b>
1201F5	<b>82089</b>
1201F5	<b>84038</b>
1201F5	<b>82089</b>
1201F5	<b>81799</b>
1201F6	<b>81813</b>
1201F9	<b>81798</b>
1201G0	<b>81797</b>
1201G1	<b>81869</b>
1201G2	<b>82016</b>
1201G4	<b>82089</b>
1201G4	<b>84038</b>
1201G4	<b>82089</b>
1201G4	<b>81799</b>
1201G5	<b>82089</b>
1201G5	<b>84038</b>
1201G5	<b>82089</b>
1201G5	<b>81799</b>
1201G6	<b>82067</b>
1201G8	<b>81798</b>
1201G9	<b>81869</b>
1201H0	<b>82063</b>
1201H0	<b>82063</b>
1201H4	<b>81753</b>
1201H5	<b>81316</b>
1201H6	<b>82066</b>
1201H7	<b>82068</b>
1201H8	<b>82032</b>
1201J0	<b>82063</b>
1201J0	<b>82063</b>
1201J1	<b>82089</b>

<b>OES</b>	<b>MAGNETI MARELLI</b>
------------	------------------------

<b>CITROËN</b>	
----------------	--

1201J1	<b>81799</b>
1201J2	<b>82089</b>
1201J2	<b>84038</b>
1201J2	<b>82089</b>
1201J2	<b>81799</b>
1201J4	<b>82094</b>
1201J6	<b>82068</b>
1201K0	<b>82094</b>
1201K1	<b>82089</b>
1201K1	<b>84038</b>
1201K1	<b>82089</b>
1201K2	<b>84020</b>
1201K5	<b>84019</b>
1201K8	<b>81869</b>
1201L2	<b>82089</b>
1201L2	<b>84038</b>
1201L2	<b>82089</b>
1201L3	<b>82063</b>
20145	<b>81560</b>
120134	<b>81367</b>
120137	<b>81822</b>
120140	<b>81367</b>
120150	<b>81512</b>
120152	<b>81642</b>
120154	<b>81353</b>
120155	<b>81353</b>
120158	<b>81513</b>
120161	<b>81512</b>
120163	<b>81554</b>
120165	<b>81642</b>
120167	<b>81642</b>
120169	<b>81572</b>
120170	<b>81752</b>
120182	<b>81753</b>
120191	<b>81642</b>
120193	<b>81711</b>
120195	<b>81368</b>
120196	<b>81346</b>
120198	<b>81710</b>
120258	<b>81572</b>
120718	<b>81556</b>
120723	<b>81556</b>
120725	<b>81513</b>
75530147	<b>81822</b>
91511136	<b>81554</b>

OES	MAGNETI MARELLI
<b>CITROËN</b>	
95548541	81822
95619748	81822
95625017	81512
95641148	81554
95641149	81672
95643824	81672
95650955	81642
95655207	81554
95655208	81512
95655209	81672
95655210	81672
95656566	81554
95656567	81512
95656568	81672
95656569	81672
95666768	81642
96047088	81353
97521368	81560
504033770	82024
1607852880	84042
1607854280	82049
1609402180	81800
1609402380	81713
1609417280	81753
1609417380	81798
1609417480	84038
1609417480	82089
1609417680	81869
1609944880	82066
1610278080	82068
1611550180	84054
1613518580	84020
7901120258	81572
9401201340	81367
9401201390	81554
9401201400	81367
9401201480	81672
9451001263	81556
9608564280	81513
9617376980	81556
9801573380	82032
9803094380	84066
9803442480	84066

OES	MAGNETI MARELLI
<b>DACIA</b>	
7700861686	81579
7701473327	81810
7701475995	84007
7701476496	81810
7701478031	84007
8200146298	81579
210101302R	84039
210108574R	84007

<b>DAEWOO</b>	
1334008	81606
1334025	81549
1334098	81549
24409355	81550
90144227	81549
90220568	81606
90272361	81606
90273361	81606
90325660	81549
90349239	81549
90443549	81550
90444359	81550
90466343	81550
92064250	81550
92065969	81550
94013802	81780
96182871	81782
96350799	81781
96351284	81780
96351969	81549
96351971	81780
96352648	81781
96352649	81780
96352650	81782
1740050812	81783
1740061810	81783
1740060D01	81783
1740070B00	81783
17400A60D01	81783
17400A60D02	81783
R1160012	81549

OES	MAGNETI MARELLI
<b>DAIHATSU</b>	
1610080001	82063
1610080001	82063
1610087109	81715
1610087182	81714
1610087183	81715
1610087184	81714
1610087185	81715
1610087390	81714
1610097234	82063
1610097234	82063
1610097404	81808
1610097411	81808
1610097404000	81808
1610097411000	81808
16100B09010	81808
16100B9010	81808

<b>FIAT</b>	
777034	81333
4243672	81415
4243679	81415
4296890	81415
4336009	81434
4458134	81436
4823810	81488
5548541	81822
5882691	81434
5882694	81415
5890406	81434
5894394	81460
5896818	81464
5896819	81464
5939200	81415
5973319	81443
5973713	81801
5999790	81460
7301300	81492
7303030	81492
7553396	81450
7574887	81436
7575827	81469
7580756	81481
7589065	81477
7597569	81309
7608844	81456

OES	MAGNETI MARELLI
-----	-----------------

FIAT	
7609204	81490
7617168	81476
7617364	81458
7626604	81463
7629033	81464
7629033	81326
7629228	81463
7631379	81464
7631494	81309
7635180	81460
7640163	81801
7648451	81347
7651586	81314
7658606	81309
7658607	81309
7661811	81490
7661813	81460
7671811	81333
7691046	81476
7691047	81476
7691820	81801
7692285	81309
7692551	81489
7692552	81463
7692555	81363
7693569	81309
7693570	81464
7694229	81460
7695555	81490
7695557	81460
7695559	81490
7696226	81464
7701137	81315
7708187	81322
7715051	81347
7715242	81801
7720987	81333
7723345	81476
7724414	81300
7737200	81333
7744397	81333
7747386	81490
7747388	81322
7750698	81303
7752928	81343

OES	MAGNETI MARELLI
-----	-----------------

FIAT	
7752928	81366
7762924	81340
7762925	81330
7762926	81329
7762986	81301
7770038	81476
7781232	81304
7783006	81315
7784977	81333
7784979	81476
7784982	81476
7784988	81333
46400058	81341
46400058	81364
46407762	81347
46407766	81363
46408312	81489
46409134	81469
46409136	81456
46409200	81368
46409201	81346
46410549	81339
46410551	81342
46410562	81344
46411355	81341
46411355	81364
46422430	81343
46422430	81366
46422512	81369
46423351	81801
46432248	81352
46437911	81343
46437911	81366
46437912	81303
46437913	81346
46437914	81346
46437915	81343
46437915	81366
46437916	81303
46444355	81341
46444355	81364
46445405	81365
46464225	81344
46515970	81352
46515971	81351

OES	MAGNETI MARELLI
-----	-----------------

FIAT	
46515972	81352
46520401	81369
46525058	81344
46526243	81370
46531183	81801
46554397	81344
46742168	81300
46757573	82086
46757574	82086
46804051	81872
46804051	81872
46805736	81370
46815125	81862
46819138	81862
55184080	81370
55184081	81369
55198358	81355
55198547	81369
55204538	82070
55209993	81872
55209993	81872
55220285	81862
55221397	82070
55225394	84008
55233943	84008
55240489	81861
55258179	81861
55263214	84008
55268277	82070
55268918	81872
55270499	84008
55271994	82070
60513151	19532/E
60555347	19532/E
60555348	19532/E
60561800	19532/E
60564048	19532/E
60586222	81331
60608898	81348
60800169	81443
60808116	19532/E
60808756	81464
60809209	81322
60810426	81322
60811328	81331

OES	MAGNETI MARELLI
<b>FIAT</b>	
60814609	<b>81352</b>
60816231	<b>81348</b>
71713045	<b>19532/E</b>
71713727	<b>81801</b>
71713728	<b>81369</b>
71716878	<b>81364</b>
71719666	<b>81333</b>
71719676	<b>81322</b>
71737965	<b>81322</b>
71737974	<b>81333</b>
71737989	<b>19532/E</b>
71737991	<b>81320</b>
71739136	<b>81642</b>
71739401	<b>81812</b>
71739779	<b>82083</b>
71742124	<b>82026</b>
71745026	<b>81862</b>
71751273	<b>81812</b>
71777350	<b>82070</b>
75530147	<b>81822</b>
76611813	<b>81460</b>
91107589	<b>81490</b>
95548541	<b>81822</b>
95619748	<b>81822</b>
95641149	<b>81672</b>
95643824	<b>81672</b>
95655209	<b>81672</b>
95655210	<b>81672</b>
95656568	<b>81672</b>
95656569	<b>81672</b>
98430541	<b>81324</b>
98435125	<b>81325</b>
98473452	<b>81316</b>
99440717	<b>81316</b>
99440930	<b>81325</b>
99459759	<b>81488</b>
504033770	<b>82024</b>
504083122	<b>81316</b>
504102572	<b>82094</b>
504248581	<b>82094</b>
1304596080	<b>81320</b>
1304612080	<b>81318</b>
1312388080	<b>81318</b>
1313021080	<b>81319</b>
1317462080	<b>81320</b>

OES	MAGNETI MARELLI
<b>FIAT</b>	
1317463080	<b>81318</b>
1317464080	<b>81318</b>
1317466080	<b>81319</b>
1609417080	<b>81797</b>
9401201340	<b>81367</b>
9401201400	<b>81367</b>
9401201480	<b>81672</b>
9463623088	<b>81800</b>
9565095580	<b>81642</b>
9565656788	<b>81512</b>
9566945680	<b>81642</b>
9566945688	<b>81642</b>
9567521488	<b>81642</b>
9569147388	<b>81713</b>
9604708880	<b>81353</b>
9627667988	<b>81642</b>
9629110980	<b>81353</b>
9631169188	<b>81797</b>
9640601280	<b>82089</b>
9640601280	<b>84038</b>
9640601280	<b>82089</b>
9640601280	<b>81799</b>
9641117180	<b>81813</b>
9654514780	<b>81869</b>
9654531880	<b>82089</b>
9654531880	<b>84038</b>
9654531880	<b>82089</b>
9654531880	<b>81799</b>
9655043180	<b>82089</b>
9655043180	<b>84038</b>
9655043180	<b>82089</b>
9655043180	<b>81799</b>
9659248280	<b>82066</b>
9663654980	<b>82089</b>
9663654980	<b>84038</b>
9663654980	<b>82089</b>
9682360280	<b>84020</b>
9684319880	<b>82068</b>
195320702402	<b>19532/E</b>
46410551E	<b>81372</b>
K68096225AA	<b>81872</b>
K68290837AA	<b>81872</b>

OES	MAGNETI MARELLI
<b>FORD</b>	
1001889	<b>81773</b>
1007714	<b>81598</b>
1020538	<b>81598</b>
1020567	<b>81716</b>
1020988	<b>81651</b>
1023645	<b>81651</b>
1031279	<b>81657</b>
1031879	<b>81522</b>
1032940	<b>81362</b>
1053879	<b>81803</b>
1059843	<b>81773</b>
1079085	<b>81802</b>
1089795	<b>82018</b>
1094596	<b>81803</b>
1096556	<b>82057</b>
1100635	<b>81816</b>
1104115	<b>81802</b>
1116996	<b>81805</b>
1119276	<b>81804</b>
1131809	<b>82057</b>
1131878	<b>81802</b>
1132607	<b>81598</b>
1136393	<b>82057</b>
1138318	<b>81803</b>
1142005	<b>81804</b>
1142427	<b>81804</b>
1143851	<b>81805</b>
1146965	<b>82057</b>
1147585	<b>81798</b>
1227902	<b>81803</b>
1229571	<b>82018</b>
1232499	<b>81800</b>
1233218	<b>81559</b>
1250684	<b>84010</b>
1250685	<b>84010</b>
1308453	<b>82057</b>
1310015	<b>84011</b>
1313167	<b>81804</b>
1313842	<b>81869</b>
1318354	<b>81656</b>
1320085	<b>81654</b>
1326374	<b>81598</b>
1336008	<b>81804</b>
1341835	<b>81805</b>
1347102	<b>81805</b>



<b>OES</b>	<b>MAGNETI MARELLI</b>
------------	------------------------

<b>FORD</b>	
1348621	<b>81798</b>
1350461	<b>81598</b>
1351130	<b>81869</b>
1359027	<b>81804</b>
1359942	<b>81798</b>
1361486	<b>81804</b>
1364152	<b>81804</b>
1364681	<b>81869</b>
1366614	<b>81798</b>
1372336	<b>82066</b>
1376162	<b>82027</b>
1381796	<b>82066</b>
1385827	<b>82057</b>
1388504	<b>82056</b>
1388504	<b>82056</b>
1406479	<b>82027</b>
1417825	<b>81805</b>
1420149	<b>81798</b>
1427914	<b>82068</b>
1429037	<b>81716</b>
1432630	<b>81800</b>
1434347	<b>81804</b>
1452907	<b>82057</b>
1455679	<b>82057</b>
1472867	<b>82027</b>
1477444	<b>81805</b>
1480869	<b>81804</b>
1517728	<b>81655</b>
1517749	<b>81651</b>
1518123	<b>81559</b>
1518911	<b>81716</b>
1528548	<b>81532</b>
1535462	<b>81369</b>
1535466	<b>81369</b>
1538412	<b>82068</b>
1538706	<b>81862</b>
1559259	<b>82068</b>
1562255	<b>81800</b>
1566239	<b>81598</b>
1566241	<b>82004</b>
1584043	<b>81804</b>
1589055	<b>82027</b>
1651816	<b>81654</b>
1680637	<b>82027</b>
1688697	<b>82027</b>

<b>OES</b>	<b>MAGNETI MARELLI</b>
------------	------------------------

<b>FORD</b>	
1694898	<b>84020</b>
1701415	<b>82057</b>
1707009	<b>81800</b>
1713348	<b>82057</b>
1715121	<b>82057</b>
1715839	<b>81869</b>
1727556	<b>84020</b>
1760659	<b>84036</b>
1766164	<b>84036</b>
1778516	<b>82027</b>
3006897	<b>81845</b>
3667653	<b>81845</b>
3715703	<b>81845</b>
3800766	<b>81845</b>
4096620	<b>81845</b>
4356532	<b>81845</b>
4356671	<b>82036</b>
4373611	<b>82036</b>
4425510	<b>82036</b>
4431771	<b>82036</b>
4448274	<b>82036</b>
4448290	<b>81845</b>
4480690	<b>82036</b>
4514060	<b>82036</b>
4551517	<b>81845</b>
5004972	<b>81532</b>
5004995	<b>81602</b>
5005058	<b>81532</b>
5005197	<b>81531</b>
5006043	<b>81602</b>
5006046	<b>81602</b>
5009186	<b>81602</b>
5009286	<b>81532</b>
5009287	<b>81602</b>
5010783	<b>81531</b>
5010875	<b>81532</b>
5010876	<b>81532</b>
5010877	<b>81602</b>
5010878	<b>81602</b>
5010880	<b>81532</b>
5011013	<b>81536</b>
5011863	<b>81602</b>
5011864	<b>81532</b>
5012322	<b>81536</b>
5012359	<b>81602</b>

<b>OES</b>	<b>MAGNETI MARELLI</b>
------------	------------------------

<b>FORD</b>	
5012773	<b>81559</b>
5013267	<b>81532</b>
5013268	<b>81602</b>
5013274	<b>81602</b>
5013320	<b>81538</b>
5020242	<b>81651</b>
5020437	<b>81650</b>
5020651	<b>81538</b>
5023817	<b>81536</b>
5024297	<b>81657</b>
5024545	<b>81559</b>
5024603	<b>81531</b>
5025607	<b>81655</b>
5025908	<b>81650</b>
5026783	<b>81650</b>
5028472	<b>81656</b>
6039328	<b>81531</b>
6050034	<b>81531</b>
6050907	<b>81531</b>
6065711	<b>81602</b>
6457409	<b>81654</b>
6683522	<b>81653</b>
6878045	<b>82004</b>
7072641	<b>81302</b>
7087382	<b>81654</b>
7269023	<b>81845</b>
19BBX8591FA	<b>81803</b>
1F1E8501BA	<b>81845</b>
1S7G8501AK	<b>81804</b>
1S7G8501AR	<b>81804</b>
1S7G8501BB	<b>81804</b>
1S7G8501BC	<b>81804</b>
2U1Q8K500BB	<b>82057</b>
3M5Q8591EA	<b>81800</b>
5L8E8501AA	<b>82036</b>
6C1Q8K500AF	<b>82066</b>
6G9N8591AA	<b>82056</b>
6G9Q8501AB	<b>82068</b>
6G9Q8591AA	<b>82068</b>
7S7G8591A2A	<b>82027</b>
7S7G8591A2B	<b>82027</b>
88BX8591AA	<b>81650</b>
88FX8591AA	<b>81651</b>
88FX8591AB	<b>81651</b>
88WF8501AB	<b>81654</b>

OES	MAGNETI MARELLI
-----	-----------------

FORD	
914FX8591AA	81559
91FX8591AA	81657
91WM8501AA	81654
91WM8501AB	81654
91WM8591AA	81654
928X8591AA	81655
92BX8591AA	81653
92BX8591BA	81650
93FX8591AA	81656
95VW8503AA	82080
95VW8503AA	82080
95VW8591AA	81773
96BX8591AA	81716
96FX8591AA	81651
96FX8591EA	81657
96MX8591AA	81598
988X8591FA	81803
988X8591FC	81803
A790X8591DA	81532
A790X8591EFA	81532
A790X8591HFA	81531
A830X8591TA	81536
A840X8591AA	81559
A840X8591ATA	81559
A840X8591AUA	81532
A840X8591BAA	81602
A840X8591BCA	81538
A840X8591JA	81536
A840X8591KA	81602
CM5G8591AA	84036
EPW20	81559
EPW38	81559
EPW40	81651
EPW41	81602
EPW50	81602
EPW51	81602
EPW52	81657
EPW55	81655
EPW60	81653
EPW61	81536
EPW63	81532
EPW65	81536
EPW67	81532
EPW68	81602
EPW7	81532

OES	MAGNETI MARELLI
-----	-----------------

FORD	
EPW70	81538
EPW71	81650
EPW74	81654
EPW743	81532
EPW746	81532
EPW76	82004
EPW79	81656
EPW80	81598
EPW81	81716
EPW82	81651
EPW85	81657
EPW985	81531
ME3M5Q8591C2A	81869
V94DD8501AA	81302
XS2E8501BD	81845
XS2E8501CC	81845
XS2E8501CF	81845
XS4J8591AC	81802
XS7Q8K500AE	81805
XS7Q8K500AM	81805

HONDA	
19200P01003	81613
19200P01004	81613
19200P14A00	81709
19200P2A004	81838
19200P2AA01	81838
19200P2AA02	81838
19200P30003	81839
19200P5TG00	81707
19200P5TG01	81707
19200P72003	81839
19200P72013	81839
19200P72A01	81839
19200PDFE01	81838
19200PE0010	81611
19200PE0660	81611
19200PH7013	81839
19200PLE005	82039
19200PLMA01	82039
19200PM3000	81613
19200PM3003	81613
19200PM3013	81613
19200PM3014	81613
19200POBA01	81708

OES	MAGNETI MARELLI
-----	-----------------

HONDA	
19200PTO003	81708
19200PTO013	81708
19200PWA003	82045
19200RB0003	84065
19200RBDE01	82093
19200RSRE01	82093
19200RSRE02	82093

HYUNDAI	
251002E000	84064
2510002500	81837
2510002501	81837
2510002502	81837
2510002566	84018
2510002577	84018
2510002588	84018
2510003010	84040
2510021000	81784
2510021010	81784
2510022010	81784
2510022012	81784
2510022650	81784
2510023001	81785
2510023002	81785
2510023010	81785
2510023011	81785
2510023022	81785
2510023511	81785
2510023513	81785
2510023530	81785
2510024030	81784
2510024040	81784
2510024060	81784
2510026015	82020
2510026016	82020
2510026660	82020
2510026900	82020
2510026901	82020
2510026902	82020
2510027000	82085
2510027010	82085
2510027400	84059
2510027900	82085
2510032120	81786
2510033111	81786

OES	MAGNETI MARELLI
-----	-----------------

HYUNDAI	
2510033120	81786
2510033132	81786
2510037102	82021
2510037200	82021
2510037201	82021
2510037202	82021
2510042000	81787
2510042001	81787
2511129000	81642
251002A000	84058
251002A001	84058
251002A010	84058
251002A201	84063
251002B000	84015
251002B700	84015
251002B710	84015

### INNOCENTI

4336009	81434
4384128	81481
5882691	81434
5890406	81434
7608844	81456
7617168	81476
7651586	81314
7691046	81476
7691047	81476
7723345	81476
7738267	81476
7748002	81476
7752928	81343
7770038	81476
7770042	81476
7784979	81476
7784982	81476
31402021	81419
38401023	81419
38402024	81419
38406025	81419
39402022	81419
46409136	81456
46410562	81344
46437911	81366
46464225	81344

OES	MAGNETI MARELLI
-----	-----------------

ISUZU	
5862023750	81708
586008905Z	81838
586008940Z	81838

### IVECO

4714636	81334
4754850	81334
4764761	81334
7303009	81334
7303056	81491
98418986	81334
98437726	81334
98438356	81332
99438900	81332
99440726	81334
99459755	81491
500300476	81332
504033770	82024
504113544	82095
504113544	82095

### JAGUAR

C2S18139	81845
C2S40055	81805
C2S43292	81845
C2S43330	81805
C2S48033	81805
C2S5120	81845
C2S51449	82068

### JEEP

4864566	81362
4864688	81664
55240489	81861
55258179	81861
55268277	82070
55268918	81872
05072697AA	84035
05072697AB	84035
05093911AB	84035
68000693AA	84011
68000693AB	84011
68027359AA	84043

OES	MAGNETI MARELLI
-----	-----------------

KIA	
251002E000	84064
2510002500	81837
2510002501	81837
2510002502	81837
2510002566	84018
2510002577	84018
2510002588	84018
2510003010	84040
2510023001	81785
2510023002	81785
2510023010	81785
2510023011	81785
2510023022	81785
2510023511	81785
2510023513	81785
2510023530	81785
2510027000	82085
2510027010	82085
2510027400	84059
2510027900	82085
2510032120	81786
2510033111	81786
2510033120	81786
2510033132	81786
2510037102	82021
2510037200	82021
2510037201	82021
2510037202	82021
2510042000	81787
2510042001	81787
251002A000	84058
251002A001	84058
251002A010	84058
251002A201	84063
251002B000	84015
251002B700	84015
251002B710	84015
251004X300	82038
OK55115100B	82038

OES	MAGNETI MARELLI
<b>LADA</b>	
4197598	<b>81999</b>
95641149	<b>81672</b>
95643824	<b>81672</b>
95655209	<b>81672</b>
95655210	<b>81672</b>
95656568	<b>81672</b>
95656569	<b>81672</b>
9401201480	<b>81672</b>
21011307010	<b>81999</b>
21011307014	<b>81999</b>
21081307010	<b>81619</b>
2108130701010	<b>81717</b>

<b>LANCIA</b>	
4192732	<b>81415</b>
4243672	<b>81415</b>
4243679	<b>81415</b>
4296890	<b>81415</b>
4336009	<b>81434</b>
4384128	<b>81481</b>
4384129	<b>81415</b>
4458134	<b>81436</b>
5882691	<b>81434</b>
5882694	<b>81415</b>
5890406	<b>81434</b>
5894394	<b>81460</b>
5896818	<b>81464</b>
5896819	<b>81464</b>
5939200	<b>81415</b>
5973319	<b>81443</b>
5973713	<b>81801</b>
5999790	<b>81460</b>
7574887	<b>81436</b>
7609204	<b>81490</b>
7617168	<b>81476</b>
7629033	<b>81464</b>
7629033	<b>81326</b>
7631379	<b>81464</b>
7635180	<b>81460</b>
7640163	<b>81801</b>
7651586	<b>81314</b>
7661811	<b>81490</b>
7661813	<b>81460</b>
7671811	<b>81333</b>
7691046	<b>81476</b>

OES	MAGNETI MARELLI
<b>LANCIA</b>	
7691047	<b>81476</b>
7691820	<b>81801</b>
7693570	<b>81464</b>
7694229	<b>81460</b>
7695555	<b>81490</b>
7695557	<b>81460</b>
7695559	<b>81490</b>
7696226	<b>81464</b>
7701137	<b>81315</b>
7708187	<b>81322</b>
7710471	<b>81347</b>
7715242	<b>81801</b>
7720987	<b>81333</b>
7723345	<b>81476</b>
7737200	<b>81333</b>
7738267	<b>81476</b>
7744397	<b>81333</b>
7747386	<b>81490</b>
7747388	<b>81322</b>
7748002	<b>81476</b>
7750698	<b>81339</b>
7762924	<b>81340</b>
7762925	<b>81330</b>
7762926	<b>81329</b>
7770034	<b>81333</b>
7770038	<b>81476</b>
7770042	<b>81476</b>
7783006	<b>81315</b>
7784977	<b>81333</b>
7784979	<b>81476</b>
7784982	<b>81476</b>
7784987	<b>81333</b>
7784988	<b>81333</b>
46400058	<b>81341</b>
46400058	<b>81364</b>
46410549	<b>81303</b>
46411355	<b>81341</b>
46411355	<b>81364</b>
46422512	<b>81369</b>
46423351	<b>81801</b>
46432248	<b>81352</b>
46435858	<b>81363</b>
46437912	<b>81339</b>
46437912	<b>81303</b>
46437916	<b>81339</b>

OES	MAGNETI MARELLI
<b>LANCIA</b>	
46437916	<b>81303</b>
46444355	<b>81341</b>
46444355	<b>81364</b>
46515970	<b>81352</b>
46515971	<b>81351</b>
46515972	<b>81352</b>
46520401	<b>81369</b>
46526243	<b>81370</b>
46531183	<b>81801</b>
46804051	<b>81872</b>
46804051	<b>81872</b>
46819138	<b>81862</b>
55184080	<b>81370</b>
55184081	<b>81369</b>
55198357	<b>81355</b>
55198358	<b>81355</b>
55198547	<b>81369</b>
55204538	<b>82070</b>
55209993	<b>81872</b>
55209993	<b>81872</b>
55221397	<b>82070</b>
55225394	<b>84008</b>
55233943	<b>84008</b>
55263214	<b>84008</b>
55268277	<b>82070</b>
55268918	<b>81872</b>
55270499	<b>84008</b>
55271994	<b>82070</b>
60586222	<b>81331</b>
60604181	<b>81355</b>
60630271	<b>81355</b>
60668487	<b>81355</b>
60800169	<b>81443</b>
60808756	<b>81464</b>
60809209	<b>81322</b>
60810426	<b>81322</b>
60811328	<b>81331</b>
60813207	<b>81355</b>
60814609	<b>81352</b>
60816018	<b>81355</b>
71713727	<b>81801</b>
71713728	<b>81369</b>
71719666	<b>81333</b>
71719676	<b>81322</b>
71737965	<b>81322</b>

<b>OES</b>	<b>MAGNETI MARELLI</b>
------------	------------------------

<b>LANCIA</b>	
71737974	<b>81333</b>
71745026	<b>81862</b>
71777350	<b>82070</b>
76611813	<b>81460</b>
91107589	<b>81490</b>
98430541	<b>81324</b>
98435125	<b>81325</b>
98456197	<b>81325</b>
99440930	<b>81325</b>
9463623088	<b>81800</b>
9565095580	<b>81642</b>
9566945688	<b>81642</b>
9567521488	<b>81642</b>
9569147388	<b>81713</b>
9604708880	<b>81353</b>
9629110980	<b>81353</b>
9640601280	<b>82089</b>
9640601280	<b>84038</b>
9640601280	<b>82089</b>
9640601280	<b>81799</b>
9654531880	<b>82089</b>
9654531880	<b>84038</b>
9654531880	<b>82089</b>
9654531880	<b>81799</b>
9655043180	<b>82089</b>
9655043180	<b>84038</b>
9655043180	<b>82089</b>
9655043180	<b>81799</b>
9663654980	<b>82089</b>
9663654980	<b>84038</b>
9663654980	<b>82089</b>
9684319880	<b>82068</b>
K68096225AA	<b>81872</b>

<b>LAND ROVER</b>	
GWP193	<b>81707</b>
GWP2602	<b>82029</b>
GWP347	<b>81707</b>
LR001309	<b>82068</b>
LR004799	<b>82057</b>
LR009392	<b>82068</b>
LR011694	<b>82068</b>
LR025302	<b>81804</b>
LR040990	<b>81804</b>
LR053310	<b>81804</b>

<b>OES</b>	<b>MAGNETI MARELLI</b>
------------	------------------------

<b>LAND ROVER</b>	
LR081578	<b>81804</b>
PEB000050	<b>81795</b>
PEB000050E	<b>81795</b>
PEB102010	<b>81707</b>
PEB102240	<b>82029</b>
PEB102240L	<b>82029</b>
PEB102420	<b>81707</b>
PEB102420L	<b>81707</b>
STC2192	<b>81597</b>
STC3342	<b>81597</b>
STC3343E	<b>81597</b>

<b>LEXUS</b>	
1610009070	<b>82051</b>
1610009340	<b>82071</b>
1610029085	<b>82051</b>
1610029495	<b>82071</b>

<b>LOTUS</b>	
GWP333	<b>81615</b>

<b>MAZDA</b>	
1201F9	<b>81798</b>
1201G8	<b>81798</b>
1E0415010	<b>81716</b>
1E0515010	<b>81598</b>
1E0615010	<b>81598</b>
1N0015010	<b>81745</b>
1N0515010	<b>81745</b>
C20115010A	<b>81598</b>
C20215010A	<b>81598</b>
C40115010	<b>81598</b>
L32715100A	<b>81804</b>
LF0115100	<b>81804</b>
LF0115100A	<b>81804</b>
LF9415010A	<b>81804</b>
LF9415100	<b>81804</b>
LF9415100A	<b>81804</b>
RF2A15100A	<b>82092</b>
RF2A15100B	<b>82092</b>
RF2A15100C	<b>82092</b>
RF5C15010A	<b>82092</b>
RF5G15010B	<b>82092</b>
RF7J15010A	<b>82092</b>
RF8G15010A	<b>82092</b>

<b>OES</b>	<b>MAGNETI MARELLI</b>
------------	------------------------

<b>MAZDA</b>	
Y40115010	<b>81798</b>
Y40115010A	<b>81798</b>
Y60115010	<b>81869</b>
Y60115010A	<b>81869</b>
Y60115010B	<b>81869</b>
Y60115S20	<b>81869</b>
Y60315100	<b>81869</b>
Y61015010A	<b>81869</b>
ZJ0115010A	<b>84060</b>
ZJ0115010B	<b>84060</b>
ZJ0115010C	<b>84060</b>

<b>MEGA</b>	
120158	<b>81513</b>
120723	<b>81556</b>
120725	<b>81513</b>
1201E3	<b>81556</b>
19109800	<b>81560</b>
49152500	<b>81560</b>
9451001263	<b>81556</b>
9608564280	<b>81513</b>
9617376980	<b>81556</b>
32641Q	<b>81560</b>
44854W	<b>81560</b>

<b>MERCEDES-BENZ</b>	
0002000301	<b>81773</b>
0002000701	<b>81773</b>
1022000520	<b>81509</b>
1022000620	<b>81509</b>
1022000920	<b>81509</b>
1022001120	<b>81509</b>
1022003901	<b>81509</b>
1022004901	<b>81509</b>
1022005001	<b>81509</b>
1032000701	<b>81507</b>
1032001701	<b>81507</b>
1032002601	<b>81507</b>
1032003701	<b>81507</b>
1042001301	<b>81724</b>
1042002701	<b>81724</b>
1042002801	<b>81722</b>
1042003001	<b>81724</b>
1042003201	<b>81724</b>
1042003301	<b>81722</b>

OES	MAGNETI MARELLI
<b>MERCEDES-BENZ</b>	
1042004401	81722
1042004501	81722
1042004601	81724
1042004701	81722
1042004801	81724
1042004901	81722
1112000401	81499
1112002101	81728
1112002201	81774
1112002301	81725
1112002401	81729
1112003901	81729
1112004001	81499
1122000110	81730
1122000123	81730
1122000201	81730
1122000401	81730
1122000901	81730
1122001101	81730
1122001401	81730
1662000320	82087
1662000420	82087
1662000520	82087
1662000620	82087
1662000720	82087
2002000001	84003
2662000720	82017
2662000820	82017
2712000201	84004
2712000201	84004
2712000401	84004
2712000401	84004
2712000501	84002
2712000601	84004
2712000901	84002
2712001001	84004
2712001001	84004
6012000220	81504
6012000720	81504
6012000920	81504
6012001120	81723
6022000020	81506
6022000120	81506
6022000220	81506
6022000420	81506

OES	MAGNETI MARELLI
<b>MERCEDES-BENZ</b>	
6022000520	81506
6052000120	81726
6052000320	81726
6052000520	81726
6052000820	81726
6072000007	82098
6112000201	82088
6112000401	82030
6112000501	82047
6112001001	82030
6112001101	82047
6112001201	82088
6132000701	82084
6162000420	81508
6162000720	81508
6262000007	84034
6402000301	82017
6422000701	82058
6422001001	82059
6422001301	82058
6422001701	82058
6422002201	82058
6462000301	82082
6462000501	82052
6462001001	82052
6462001301	82052
6462001601	82052
6512000201	84025
6512000401	84046
6512001101	84044
6512001301	84044
6512001901	84044
6512002100	84044
6512002301	84025
6512003101	84046
6512003301	84046
6512003501	84047
6512004101	84048
6512006401	84044
6512006801	84044
602200022080	81506
646200160180	82052

OES	MAGNETI MARELLI
<b>MG</b>	
GWP2602	82029
GWP333	81615
PEB102240	82029
<b>MINI</b>	
11511485846	81861
11517510803	81861
11517513062	81861
11517520123	84013
11517550484	82032
11517790871	81821
11517805992	81869
11517829914	81861
11517829922	81861
11518512443	84026
11518577891	84050
11518577893	84051
11518586719	84050
11518586721	84051
11518623574	84049
<b>MITSUBISHI</b>	
1300A095	82049
1300A097	84042
1300A107	82049
M345611	81574
M855991	81574
MD030863	81784
MD050450	81787
MD168048	81787
MD168050	81787
MD179030	81731
MD300799	81731
MD301847	81787
MD306414	81731
MD4667660	81733
MD664616	81787
MD972001	81787
MD972052	81786
MD972456	81731
MD974649	81784
MD997076	81784
MD997084	81787
MD997150	81787
MD997151	81787

<b>OES</b>	<b>MAGNETI MARELLI</b>
------------	------------------------

<b>MITSUBISHI</b>	
MD997160	<b>81787</b>
MD997170	<b>81787</b>
MD997417	<b>81786</b>
MD997609	<b>81784</b>
MD997618	<b>81787</b>
MD997621	<b>81786</b>
MN143664	<b>82049</b>
MN980134	<b>84011</b>
MN980266	<b>84011</b>
MN982187	<b>82068</b>
MN982325	<b>82068</b>
MN982556	<b>81869</b>
MW30620725	<b>81814</b>

<b>NISSAN</b>	
---------------	--

7701472182	<b>81814</b>
7701472625	<b>81855</b>
7701474190	<b>81855</b>
8200129206	<b>81855</b>
2101000Q0C	<b>82069</b>
2101000Q0E	<b>81810</b>
2101000Q0E	<b>84007</b>
2101000Q0M	<b>82098</b>
2101000Q2C	<b>84034</b>
2101000Q2F	<b>84003</b>
2101000QAS	<b>81810</b>
210100M300	<b>81744</b>
210100M301	<b>81744</b>
2101019B25	<b>81743</b>
210101F700	<b>81742</b>
210101HC0A	<b>84003</b>
2101024B25	<b>81743</b>
210103AA0B	<b>84003</b>
2101041B02	<b>81742</b>
2101041B03	<b>81742</b>
210104A00F	<b>84017</b>
2101053J00	<b>81736</b>
2101053J01	<b>81736</b>
2101053Y00	<b>81744</b>
2101053Y01	<b>81744</b>
2101057J00	<b>81745</b>
2101057J01	<b>81745</b>
2101057J02	<b>81745</b>
2101057J03	<b>81745</b>
2101057J25	<b>81745</b>

<b>OES</b>	<b>MAGNETI MARELLI</b>
------------	------------------------

<b>NISSAN</b>	
2101057J26	<b>81745</b>
2101057J27	<b>81745</b>
210106N225	<b>84061</b>
210106N226	<b>84061</b>
2101070J00	<b>81736</b>
2101071J00	<b>81744</b>
2101099B00	<b>81742</b>
210109C600	<b>82053</b>
210109F600	<b>82028</b>
210109F605	<b>82028</b>
21010AD200	<b>82023</b>
21010AD225	<b>82023</b>
21010AD226	<b>82023</b>
21010AW300	<b>81868</b>
21010BN700	<b>81810</b>
21010BX000	<b>82014</b>
21010ED00A	<b>84003</b>
21010ED025	<b>84003</b>
21010EE025	<b>84003</b>
21010G5510	<b>82054</b>
21010G5526	<b>82054</b>
21010G5585	<b>82054</b>
21010G5586	<b>82054</b>
21010G5594	<b>82054</b>
21010G8215	<b>82054</b>
21010R7400	<b>11706T</b>
B10101HC0A	<b>84003</b>
B1010ED00A	<b>84003</b>
BA010G5586	<b>82054</b>
BA010G8125	<b>82054</b>

<b>OPEL</b>	
-------------	--

1151669	<b>81362</b>
1334004	<b>81543</b>
1334008	<b>81606</b>
1334011	<b>81681</b>
1334014	<b>81605</b>
1334016	<b>81684</b>
1334023	<b>81543</b>
1334024	<b>81681</b>
1334025	<b>81549</b>
1334027	<b>81544</b>
1334031	<b>81687</b>
1334034	<b>81685</b>
1334041	<b>81550</b>

<b>OES</b>	<b>MAGNETI MARELLI</b>
------------	------------------------

<b>OPEL</b>	
1334046	<b>82005</b>
1334050	<b>81550</b>
1334052	<b>81687</b>
1334053	<b>81550</b>
1334054	<b>81551</b>
1334059	<b>81846</b>
1334065	<b>81549</b>
1334066	<b>82005</b>
1334067	<b>81812</b>
1334069	<b>81847</b>
1334070	<b>81543</b>
1334071	<b>81544</b>
1334072	<b>81846</b>
1334073	<b>81836</b>
1334075	<b>81812</b>
1334077	<b>81817</b>
1334078	<b>81818</b>
1334079	<b>81749</b>
1334082	<b>81795</b>
1334083	<b>81812</b>
1334098	<b>81549</b>
1334102	<b>81685</b>
1334105	<b>81687</b>
1334107	<b>81685</b>
1334112	<b>81597</b>
1334114	<b>81748</b>
1334115	<b>81746</b>
1334117	<b>81747</b>
1334118	<b>81747</b>
1334119	<b>81550</b>
1334121	<b>81750</b>
1334123	<b>81362</b>
1334124	<b>81597</b>
1334128	<b>84027</b>
1334130	<b>81749</b>
1334131	<b>81846</b>
1334135	<b>81751</b>
1334137	<b>81550</b>
1334139	<b>81550</b>
1334140	<b>81846</b>
1334142	<b>82083</b>
1334143	<b>81836</b>
1334145	<b>82011</b>
1334147	<b>81872</b>
1334147	<b>81872</b>

OES	MAGNETI MARELLI
<b>OPEL</b>	
1334154	81812
1334166	82011
1334169	84027
1334190	82070
1334207	81862
1334210	84027
1334219	84027
1334228	84027
1334240	84053
1334242	81872
1334268	84005
1334282	81812
1334284	81872
1334284	81872
1334647	81862
1334648	84057
1334711	81862
1334756	81750
4401595	81855
4404098	81574
4408028	81814
4409162	81574
4431125	82069
4501293	81834
4501294	81835
4506045	81855
4708767	81862
4709352	84017
4804957	81812
4805174	84014
4813567	81812
6334000	81550
6334001	81862
6334002	81812
6334003	81352
6334019	81836
6334035	81817
6334038	81847
6334039	81818
6334042	81812
6334043	84057
6334048	81836
9109595	81855
9161593	81834
9161594	81835

OES	MAGNETI MARELLI
<b>OPEL</b>	
9192370	81550
9192793	81549
9192797	82005
9194747	81812
9199592	81817
9199595	81818
12585226	81812
12591894	81812
12658266	84053
12667387	84053
12855462	81862
24405895	82083
24439798	81812
24461382	81812
24467301	81812
24469102	82011
25192709	84027
25193406	84027
55221397	82070
55561623	84027
55579016	84027
55595610	84027
90076952	81543
90091035	81544
90144227	81549
90183273	81543
90220568	81606
90234200	81681
90284913	81605
90325660	81549
90325661	81681
90349239	81549
90349241	81543
90409912	81544
90443549	81550
90444079	82005
90444123	81551
90444311	81550
90444649	81846
90512535	81597
90540478	81747
90541671	81597
90542606	81749
90543277	81846
90543935	81751

OES	MAGNETI MARELLI
<b>OPEL</b>	
91159773	81814
92149009	84057
93161595	82069
93170142	81749
93170697	81846
93178602	81812
93179114	81872
93179114	81872
93182041	81847
93182042	81818
93182043	81747
93189336	81862
93194246	84017
93195466	81862
94124093	81684
94341998	81687
94386207	81685
96440224	84014
97101319	81685
97101320	81687
97110386	81685
97110387	81687
97114682	81746
97114683	81748
97135548	81750
97220278	81847
97287175	81836
97351178	81836
98109416	84005
7701479043	81814
R1160032	81550
<b>PEUGEOT</b>	
1201E0	81353
1201E1	82089
1201E1	84038
1201E1	82089
1201E1	81799
1201E3	81556
1201E4	81513
1201E5	81753
1201E6	81513
1201E7	82089
1201E7	84038
1201E7	82089



OES	MAGNETI MARELLI
-----	-----------------

PEUGEOT	
1201E7	81799
1201E8	81800
1201E9	81813
1201A1	81711
1201A2	81753
1201A3	81752
1201A4	81642
1201A5	81712
1201A6	81844
1201A7	81353
1201A8	81642
1201C4	81713
1201C5	81353
1201C6	81353
1201C7	81844
1201C9	81316
1201F2	82042
1201F4	82089
1201F4	84038
1201F4	82089
1201F4	81799
1201F5	82089
1201F5	84038
1201F5	82089
1201F5	81799
1201F6	81813
1201F9	81798
1201G0	81797
1201G1	81869
1201G2	82016
1201G4	82089
1201G4	84038
1201G4	82089
1201G4	81799
1201G5	82089
1201G5	84038
1201G5	82089
1201G5	81799
1201G6	82067
1201G8	81798
1201G9	81869
1201H0	82063
1201H0	82063
1201H4	81753
1201H5	81316

OES	MAGNETI MARELLI
-----	-----------------

PEUGEOT	
1201H6	82066
1201H7	82068
1201H8	82032
1201J0	82063
1201J0	82063
1201J1	82089
1201J1	81799
1201J2	82089
1201J2	84038
1201J2	82089
1201J2	81799
1201J4	82094
1201J6	82068
1201K0	82094
1201K1	82089
1201K1	84038
1201K1	82089
1201K2	84020
1201K5	84019
1201K8	81869
1201L2	82089
1201L2	84038
1201L2	82089
1201L3	82063
1201L9	81862
120119	81552
120129	81552
120130	81671
120134	81367
120136	81822
120137	81822
120139	81554
120140	81367
120145	81560
120148	81672
120150	81512
120151	81672
120152	81642
120154	81353
120155	81353
120158	81513
120160	81672
120161	81512
120162	81512
120163	81554

OES	MAGNETI MARELLI
-----	-----------------

PEUGEOT	
120165	81642
120167	81642
120170	81752
120182	81753
120191	81642
120193	81711
120195	81368
120196	81346
120198	81710
120239	81671
120240	81552
120250	81552
120255	81552
120256	81671
120258	81572
120267	81552
120268	81671
120434	81572
120718	81556
120723	81556
120725	81513
96047088	81353
504033770	82024
1607854280	82049
1609402180	81800
1609417380	81798
1609417480	84038
1609417480	82089
1611550180	84054
1613518580	84020
9451001263	81556
9608564280	81513
9617376980	81556
9801573380	82032
9803094380	84066
9803442480	84066
94012010390	81554

PUCH	
1032002601	81507
6022000020	81506
6022000220	81506

OES	MAGNETI MARELLI
<b>RENAULT</b>	
7303056	<b>81491</b>
5001001274	<b>81334</b>
7438610006	<b>82056</b>
7438610006	<b>82056</b>
7438610035	<b>82056</b>
7438610035	<b>82056</b>
7700105176	<b>84039</b>
7700105176	<b>81806</b>
7700105378	<b>84039</b>
7700105378	<b>81806</b>
7700106101	<b>81761</b>
7700107845	<b>81761</b>
7700274330	<b>84039</b>
7700274330	<b>81806</b>
7700736091	<b>81661</b>
7700859931	<b>81760</b>
7700861627	<b>81761</b>
7700861686	<b>81579</b>
7700864596	<b>81762</b>
7700866518	<b>81578</b>
7700871801	<b>81760</b>
7701041348	<b>81762</b>
7701459820	<b>81572</b>
7701460145	<b>81828</b>
7701461006	<b>81828</b>
7701461336	<b>81664</b>
7701461405	<b>81576</b>
7701462145	<b>81573</b>
7701462145	<b>81811</b>
7701462491	<b>81573</b>
7701462491	<b>81811</b>
7701462808	<b>81334</b>
7701462809	<b>81574</b>
7701463014	<b>81660</b>
7701463111	<b>81574</b>
7701463182	<b>81576</b>
7701463377	<b>81573</b>
7701463377	<b>81811</b>
7701463397	<b>81574</b>
7701464030	<b>81608</b>
7701464054	<b>81756</b>
7701464054	<b>81853</b>
7701464736	<b>81574</b>
7701465122	<b>81851</b>
7701465513	<b>81666</b>

OES	MAGNETI MARELLI
<b>RENAULT</b>	
7701465643	<b>81755</b>
7701465816	<b>81574</b>
7701466152	<b>81754</b>
7701466419	<b>81573</b>
7701466419	<b>81811</b>
7701466420	<b>81756</b>
7701466420	<b>81853</b>
7701466571	<b>81667</b>
7701466578	<b>81574</b>
7701466778	<b>81757</b>
7701466779	<b>81758</b>
7701466788	<b>81759</b>
7701467153	<b>81596</b>
7701467153	<b>81854</b>
7701467223	<b>81608</b>
7701467278	<b>81325</b>
7701467622	<b>81760</b>
7701467642	<b>81852</b>
7701468342	<b>81334</b>
7701468491	<b>81574</b>
7701470879	<b>81834</b>
7701470880	<b>81835</b>
7701472182	<b>81814</b>
7701472625	<b>81855</b>
7701473327	<b>81810</b>
7701473365	<b>81574</b>
7701473784	<b>81334</b>
7701474190	<b>81855</b>
7701474435	<b>81868</b>
7701475995	<b>84007</b>
7701476496	<b>81810</b>
7701478018	<b>81579</b>
7701478031	<b>81810</b>
7701478031	<b>84007</b>
7701478830	<b>82098</b>
7701478846	<b>82099</b>
7701478923	<b>82090</b>
7701478924	<b>82091</b>
7701478925	<b>84024</b>
7701479043	<b>84009</b>
7701479114	<b>84006</b>
7701633125	<b>81661</b>
7703002053	<b>81762</b>
7901120258	<b>81572</b>
8200037682	<b>82091</b>

OES	MAGNETI MARELLI
<b>RENAULT</b>	
8200042514	<b>81761</b>
8200042880	<b>81820</b>
8200088663	<b>81762</b>
8200129206	<b>81855</b>
8200146297	<b>84039</b>
8200146297	<b>81806</b>
8200146298	<b>81579</b>
8200146301	<b>81578</b>
8200238333	<b>81820</b>
8200266947	<b>81762</b>
8200266950	<b>81820</b>
8200332040	<b>82069</b>
8200397732	<b>82090</b>
8200397735	<b>82091</b>
8200428447	<b>84039</b>
8200428447	<b>81806</b>
8200582675	<b>84039</b>
8200582675	<b>81806</b>
8200702750	<b>82090</b>
8200702755	<b>82091</b>
8200702762	<b>84024</b>
8671019520	<b>82091</b>
9635018180	<b>82042</b>
9637506680	<b>81844</b>
9640344280	<b>81844</b>
9641117180	<b>81813</b>
210100906R	<b>84003</b>
210101832R	<b>82090</b>
210103314R	<b>82091</b>
210105296R	<b>84039</b>
210105296R	<b>81806</b>
210108030R	<b>84003</b>
210108796R	<b>84034</b>
210108845R	<b>82090</b>
210109189R	<b>84024</b>
<b>ROVER</b>	
12G120	<b>81419</b>
12G1771	<b>81419</b>
GWP101	<b>81419</b>
GWP102	<b>81419</b>
GWP104	<b>81419</b>
GWP105	<b>81419</b>
GWP1143	<b>81611</b>
GWP117	<b>81419</b>

OES	MAGNETI MARELLI
-----	-----------------

ROVER	
GWP132	81419
GWP134	81419
GWP193	81707
GWP195	81556
GWP2154	81843
GWP2155	81843
GWP2157	81613
GWP2161	81613
GWP2162	81302
GWP2163	81613
GWP2166	81843
GWP2523	81362
GWP2602	82029
GWP333	81615
GWP336	81614
GWP337	81672
GWP338	81672
GWP341	81556
GWP342	81708
GWP343	81709
GWP345	81708
GWP346	81556
GWP347	81707
PEB102010	81707
PEB102240	82029
PEB102420	81707
PEB102420L	81707

SAAB	
1334117	81747
1334118	81747
1334648	84057
4770970	81846
4772711	81747
8821944	81846
8822710	81764
8822744	81764
8822793	81764
9321951	81764
12566029	84057
12621284	81812
12630084	81812
55488983	81872
55568637	81872
55568637	81872

OES	MAGNETI MARELLI
-----	-----------------

SAAB	
90540478	81747
93181118	81812
93191762	81872
93191762	81872
125888982	84057

SEAT	
021121004	81773
022121011	81866
026121005	81522
026121010	82080
026121010	82080
028121004	81528
031121004	81525
036121005	81776
037121010	82080
037121010	82080
038121011	81706
045121011	81791
071121005	81856
0131121005A	81525
021121004V	81773
021121004X	81773
022121011X	81866
026121005A	81522
026121005C	81522
026121005E	81522
026121005G	81522
026121005H	81522
026121010C	82080
026121010C	82080
026121010CV	82080
026121010CV	82080
026121010CX	82080
026121010CX	82080
026121010E	82080
026121010E	82080
026121010F	82080
026121010F	82080
026121010FV	82080
026121010FV	82080
026121010FX	82080
026121010FX	82080
026121010V	82080
026121010V	82080

OES	MAGNETI MARELLI
-----	-----------------

SEAT	
026121010X	82080
026121010X	82080
028121004V	81528
028121004X	81528
030121004A	81524
030121004B	81524
030121005D	81527
030121005H	81524
030121005L	81524
030121005LV	81524
030121005LX	81524
030121005N	81527
030121005NV	81527
030121005NX	81527
030121005S	81775
030121005T	81527
030121005TV	81527
030121005TX	81527
030121008A	81775
030121008AV	81775
030121008AX	81775
030121008C	81775
030121008D	81527
030121008M	81527
031121004A	81525
031121004AV	81525
031121004AX	81525
031121004V	81525
031121004X	81525
031121005A	81525
031121005C	81525
031121005CV	81525
031121005CX	81525
036121005D	81776
036121005DX	81776
036121005E	81777
036121005EV	81777
036121005EX	81777
036121005F	81840
036121005G	81840
036121005GX	81840
036121005M	81776
036121005P	81840
036121005Q	81777
036121005QX	81777

OES	MAGNETI MARELLI
<b>SEAT</b>	
036121005S	81777
036121005SV	81777
036121005SX	81777
036121008G	81840
036121008GX	81840
036121008K	81777
036121008L	81777
036121008LX	81777
036121008M	81777
036121008MX	81777
037121010A	82080
037121010A	82080
037121010AV	82080
037121010AV	82080
037121010AX	82080
037121010AX	82080
037121010BX	82080
037121010BX	82080
037121010C	82080
037121010C	82080
038121011A	81706
038121011AV	81706
038121011AX	81706
038121011C	81816
038121011CX	81816
038121011D	81816
038121011G	84011
038121011GX	84011
038121011H	84011
038121011HX	84011
038121011JX	84011
038121011KX	84011
03C121005LX	81865
03C121005N	82097
03C121005NX	82097
03C121005R	82097
03C121005RX	82097
03C121005S	81865
03C121008B	82097
03C121008C	81865
03C121008CX	81865
03C121008E	82097
03C121008F	81865
03C121008FX	81865
03C121008J	81865

OES	MAGNETI MARELLI
<b>SEAT</b>	
03C121008JX	81865
03D121005	81867
03D121005X	81867
03D121013B	81867
03F121004A	84045
03F121004B	84045
03F121004D	84045
03F121004E	84045
03F121004EX	84045
03F121004F	84045
03F121005	84045
03L121011	84001
03L121011H	84001
03L121011J	84001
03L121011P	84001
045121011B	81791
045121011C	84052
045121011F	84010
045121011FX	84010
045121011G	82013
045121011HX	84010
045121011J	82013
047121013J	81807
04C121600K	84062
04E121600AD	84062
04E121600AG	84062
04E121600AL	84062
04E121600AQ	84062
04E121600AR	84062
04E121600D	84062
04E121600H	84062
04E121600P	84062
066121011C	81856
066121011CX	81856
066121011D	81856
068121005A	81522
068121010A	82080
068121010A	82080
068121010AX	82080
068121010AX	82080
068121011E	81703
06A121011C	81703
06A121011E	81703
06A121011EV	81703
06A121011EX	81703

OES	MAGNETI MARELLI
<b>SEAT</b>	
06A121011F	81703
06A121011G	81703
06A121011H	81703
06A121011HV	81703
06A121011HX	81703
06A121011L	81703
06A121011LV	81703
06A121011LX	81703
06A121011T	81703
06A121011TX	81703
06A121012D	81703
06A121012G	81703
06B121011	81702
06B121011A	81702
06B121011B	81702
06B121011BV	81702
06B121011BX	81702
06B121011C	81702
06B121011CV	81702
06B121011CX	81702
06B121011E	81702
06B121011EV	81702
06B121011EX	81702
06B121011H	81702
06B121011L	81702
06B121011LX	81702
06B121011M	81702
06B121011N	81702
06B121011NX	81702
06B121011Q	81702
06C121004C	81819
06C121004G	81819
06C121004H	81819
06C121004HX	81819
06E121018A	82015
06F121011	82025
06F121011X	82025
06H121026AF	84016
06H121026BA	84016
06H121026BE	84016
06H121026BF	84016
06H121026CC	84016
06H121026CF	84016
06H121026CP	84016
06H121026CQ	84016

OES	MAGNETI MARELLI
-----	-----------------

SEAT	
06H121026DD	84016
06K121011	84037
06L121005A	84037
06L121012	84037
06L121012A	84037
HB03200000	81415
SE020032000A	81415
SE021032000A	81498
SE700032000C	81497

SKODA	
-------	--

028121004	81528
038121011	81706
045121011	81791
078121006	81842
028121004V	81528
028121004X	81528
030121005D	81527
030121005N	81527
030121005NV	81527
030121005NX	81527
036121005E	81777
036121005EV	81777
036121005EX	81777
036121005Q	81777
036121005QX	81777
036121005S	81777
036121005SV	81777
036121005SX	81777
036121008K	81777
036121008KX	81777
036121008L	81777
036121008M	81777
036121008MX	81777
038121011A	81706
038121011AV	81706
038121011AX	81706
038121011C	81816
038121011CX	81816
038121011D	81816
038121011G	84011
038121011GX	84011
038121011H	84011
038121011HX	84011
038121011J	84011

OES	MAGNETI MARELLI
-----	-----------------

SKODA	
-------	--

038121011JX	84011
038121011KX	84011
03C121005B	81865
03C121005C	81865
03C121005D	81865
03C121005DX	81865
03C121005K	81865
03C121005KX	81865
03C121005L	81865
03C121005S	81865
03C121008C	81865
03C121008CX	81865
03C121008F	81865
03C121008FX	81865
03C121008J	81865
03C121008JX	81865
03D121005	81867
03D121005X	81867
03D121013B	81867
03F121004A	84045
03F121004B	84045
03F121004D	84045
03F121005	84045
03L121011	84001
03L121011G	84011
03L121011GX	84011
03L121011H	84001
03L121011J	84001
03L121011P	84001
045121011B	81791
045121011BX	81791
045121011C	84052
045121011F	84010
045121011FX	84010
045121011G	82013
045121011H	84010
045121011HX	84010
045121011J	82013
04C121600K	84062
04E121600AD	84062
04E121600AG	84062
04E121600AL	84062
04E121600AQ	84062
04E121600AR	84062
04E121600D	84062

OES	MAGNETI MARELLI
-----	-----------------

SKODA	
-------	--

04E121600H	84062
04E121600P	84062
059121004B	81705
059121004C	81705
059121004CX	81705
059121004D	81705
059121004E	81705
059121004EV	81705
059121004EX	81705
06A121011C	81703
06A121011E	81703
06A121011EV	81703
06A121011EX	81703
06A121011F	81703
06A121011G	81703
06A121011H	81703
06A121011HV	81703
06A121011HX	81703
06A121011L	81703
06A121011LV	81703
06A121011LX	81703
06A121011T	81703
06A121011TX	81703
06A121012G	81703
06B121011	81702
06B121011A	81702
06B121011B	81702
06B121011BV	81702
06B121011BX	81702
06B121011C	81702
06B121011CV	81702
06B121011CX	81702
06B121011E	81702
06B121011EV	81702
06B121011EX	81702
06B121011H	81702
06B121011L	81702
06B121011LX	81702
06B121011M	81702
06B121011N	81702
06B121011NX	81702
06B121011Q	81702
06C121004C	81819
06C121004G	81819
06C121004H	81819

OES	MAGNETI MARELLI
-----	--------------------

**SKODA**

06C121004HX	<b>81819</b>
06E121018A	<b>82015</b>
06F121011	<b>82025</b>
06F121011X	<b>82025</b>
06H121026AB	<b>84016</b>
06H121026AF	<b>84016</b>
06H121026AG	<b>84016</b>
06H121026BA	<b>84016</b>
06H121026BE	<b>84016</b>
06H121026BF	<b>84016</b>
06H121026CC	<b>84016</b>
06H121026CP	<b>84016</b>
06H121026DD	<b>84016</b>
06H121026N	<b>84016</b>
06J121026A	<b>84016</b>
06J121026AG	<b>84016</b>
06J121026F	<b>84016</b>
06J121026G	<b>84016</b>
06K121011	<b>84037</b>
06L121005A	<b>84037</b>
06L121012	<b>84037</b>
06L121012A	<b>84037</b>
078121004H	<b>81842</b>
078121004HX	<b>81842</b>
078121004J	<b>81842</b>
078121004JV	<b>81842</b>
078121004JX	<b>81842</b>
078121004L	<b>81842</b>
078121004Q	<b>81842</b>
078121004QX	<b>81842</b>
078121004R	<b>81842</b>
078121006A	<b>81842</b>
078121006X	<b>81842</b>

**SMART**

1352000001	<b>82049</b>
2002000001	<b>84003</b>
6602000120	<b>84012</b>
3165V003	<b>84012</b>
4681V002	<b>84012</b>

OES	MAGNETI MARELLI
-----	--------------------

**SSANGYONG**

1042001301	<b>81724</b>
1042002701	<b>81724</b>
1042003001	<b>81724</b>
1042003201	<b>81724</b>
1042004601	<b>81724</b>
1042004801	<b>81724</b>
6022000220	<b>81506</b>

**SUBARU**

1740082850	<b>81858</b>
------------	--------------

**SUZUKI**

1741085E00	<b>81862</b>
1740050812	<b>81783</b>
1740060810	<b>81790</b>
1740060811	<b>81790</b>
1740060812	<b>81790</b>
1740060813	<b>81790</b>
1740060814	<b>81790</b>
1740060815	<b>81790</b>
1740061810	<b>81783</b>
1740061820	<b>82050</b>
1740082810	<b>81789</b>
1740082811	<b>81789</b>
1740082812	<b>81789</b>
1740082823	<b>81858</b>
1740082830	<b>81789</b>
1740082850	<b>81858</b>
1740082851	<b>81858</b>
1740083810	<b>81789</b>
1740083811	<b>81789</b>
1740083812	<b>81789</b>
1740083814	<b>81789</b>
1740083815	<b>81789</b>
1740083820	<b>81789</b>
1740051K00	<b>84017</b>
1740058M00	<b>84017</b>
1740060A02	<b>81790</b>
1740060A04	<b>81790</b>
1740060D01	<b>81783</b>
1740069G00	<b>82026</b>
1740069G01	<b>82026</b>
1740069G02	<b>82026</b>
1740069G04	<b>82026</b>
1740069L00	<b>84017</b>

OES	MAGNETI MARELLI
-----	--------------------

**SUZUKI**

1740070B00	<b>81783</b>
1740073J00	<b>81798</b>
1740078J00	<b>84057</b>
1740079J50	<b>81352</b>
1740079J80	<b>81872</b>
1740079J80	<b>81872</b>
17400A60D01	<b>81783</b>
17400A60D02	<b>81783</b>
17400M67L00	<b>84017</b>
17400M67L10	<b>84017</b>
17400N86J00	<b>81862</b>
1740973J00	<b>81798</b>
1741066G00	<b>81642</b>
1741067G00	<b>81713</b>
1741067JG0	<b>81868</b>
1741084A11	<b>84007</b>

**TALBOT**

120139	<b>81554</b>
120145	<b>81560</b>
120163	<b>81554</b>
120169	<b>81572</b>
120258	<b>81572</b>
120434	<b>81572</b>
19109800	<b>81560</b>
49152500	<b>81560</b>
7901120258	<b>81572</b>
94012010390	<b>81554</b>
32641Q	<b>81560</b>
44854W	<b>81560</b>

**TATA**

570320109901	<b>81862</b>
570420109915	<b>82070</b>

**TOYOTA**

1610009020	<b>81767</b>
1610009050	<b>81767</b>
1610009051	<b>81815</b>
1610009051	<b>81766</b>
1610009060	<b>81768</b>
1610009061	<b>81768</b>
1610009070	<b>82051</b>
1610009080	<b>82012</b>
1610009120	<b>81815</b>

OES

TOYOTA	
1610009120	81766
1610009130	82012
1610009140	82048
1610009141	82048
1610009240	82063
1610009240	82063
1610009310	82012
1610009340	82071
1610009450	82063
1610009450	82063
1610009500	84030
1610009501	84030
1610009610	84029
1610009640	84054
1610019105	81771
1610019106	81771
1610019195	81771
1610019225	81771
1610019226	81771
1610019255	81815
1610019255	81766
1610019265	81769
1610019295	81815
1610019295	81766
1610019296	81815
1610019296	81766
1610019305	81769
1610028040	82055
1610028041	82055
1610029085	82051
1610029095	82012
1610029115	81808
1610029125	82048
1610029135	82022
1610029155	81809
1610029156	81809
1610029175	82012
1610029185	82044
1610029195	81809
1610029196	81809
1610029415	82012
1610029495	82071
1610039395	81821
1610039465	84030
1610039466	84030

OES

TOYOTA	
1610039525	84029
1610039535	84028
1610040110	84031
1610080003	82063
1610080003	82063
1610080004	84032
1610080005	84031
1610080007	82063
1611009020	81815
1611009021	81815
1611019107	81771
1611019146	81815
1611019185	81769
1611019205	81815
1611079025	81770
1611079026	81770
1611079045	81770
1611079135	81770
161000Q010	82063
161000Q010	82063
16100WA010	84026
SU00100204	81713
SU00100596	81798

VAUXHALL	
1334014	81605
1334025	81549
1334041	81550
1334050	81550
1334053	81550
1334065	81549
1334069	81847
1334073	81836
1334077	81817
1334078	81818
1334098	81549
1334101	81597
1334117	81747
1334118	81747
1334119	81550
1334135	81751
1334137	81550
1334143	81836
4408028	81814
4431125	82069

OES

VAUXHALL	
6334019	81836
6334039	81818
6334043	84057
6334048	81836
9109595	81855
9112098	81574
9161593	81834
9161594	81835
9192370	81550
9192793	81549
9192797	82005
9194747	81812
9199592	81817
9199595	81818
9201182	81846
9201450	81855
12585226	81812
12591894	81812
24405895	82083
24439798	81812
24461382	81812
24469102	82011
90076952	81543
90091035	81544
90144227	81549
90183273	81543
90220568	81606
90234200	81681
90272361	81606
90273923	81681
90284813	81605
90284913	81605
90295078	81605
90325660	81549
90325661	81681
90349239	81549
90349241	81543
90409912	81544
90443549	81550
90444079	82005
90444123	81551
90444311	81550
90444649	81846
90512535	81597
90540478	81747

OES	MAGNETI MARELLI
<b>VAUXHALL</b>	
90541671	<b>81597</b>
90542606	<b>81749</b>
90543277	<b>81846</b>
90543935	<b>81751</b>
91151669	<b>81362</b>
91159773	<b>81814</b>
93161595	<b>82069</b>
93170401	<b>81812</b>
93170697	<b>81846</b>
93172718	<b>81812</b>
93177340	<b>81862</b>
93178602	<b>81812</b>
93182041	<b>81847</b>
93182042	<b>81818</b>
93182043	<b>81747</b>
93195466	<b>81862</b>
94124093	<b>81684</b>
94341998	<b>81687</b>
94386207	<b>81685</b>
96351969	<b>81549</b>
96440224	<b>84014</b>
97101319	<b>81685</b>
97101320	<b>81687</b>
97110386	<b>81685</b>
97110387	<b>81687</b>
97114682	<b>81746</b>
97114683	<b>81748</b>
97135548	<b>81750</b>
97220278	<b>81847</b>
97251178	<b>81836</b>
97287175	<b>81836</b>
7701479043	<b>81814</b>
R1160012	<b>81549</b>
R1160018	<b>81606</b>
R1160024	<b>81605</b>
R1160025	<b>81685</b>
R1160028	<b>81687</b>
R1160030	<b>82005</b>
R1160031	<b>81551</b>
R1160032	<b>81550</b>
R1160036	<b>81746</b>
R1160037	<b>81685</b>
R1160038	<b>81748</b>
R1160039	<b>81750</b>
R1160043	<b>81846</b>

OES	MAGNETI MARELLI
<b>VAUXHALL</b>	
R1160044	<b>81362</b>
<b>VOLKSWAGEN</b>	
021121004	<b>81773</b>
022121011	<b>81866</b>
023121004	<b>81772</b>
026121005	<b>81522</b>
026121005	<b>82080</b>
026121005	<b>82080</b>
026121010	<b>82080</b>
026121010	<b>82080</b>
028121004	<b>81528</b>
031121004	<b>81525</b>
036121005	<b>81776</b>
037121010	<b>82080</b>
037121010	<b>82080</b>
038121011	<b>81706</b>
045121011	<b>81791</b>
050121010	<b>81529</b>
052121004	<b>81520</b>
052121005	<b>81520</b>
052121019	<b>81520</b>
055121010	<b>82001</b>
056121005	<b>81521</b>
056121011	<b>82001</b>
068121005	<b>81521</b>
068121010	<b>82001</b>
069121004	<b>81593</b>
071121005	<b>81856</b>
073121004	<b>81833</b>
073121005	<b>81833</b>
074121004	<b>81701</b>
078121006	<b>81842</b>
00A121010	<b>81774</b>
0131121005A	<b>81525</b>
021121004A	<b>81773</b>
021121004V	<b>81773</b>
021121004X	<b>81773</b>
022121011A	<b>81866</b>
022121011L	<b>81866</b>
022121011V	<b>81866</b>
022121011X	<b>81866</b>
023121004V	<b>81772</b>
023121004X	<b>81772</b>
025121010C	<b>81832</b>

OES	MAGNETI MARELLI
<b>VOLKSWAGEN</b>	
025121010CV	<b>81832</b>
025121010CX	<b>81832</b>
026121005A	<b>81522</b>
026121005A	<b>82080</b>
026121005A	<b>82080</b>
026121005C	<b>81522</b>
026121005C	<b>82080</b>
026121005C	<b>82080</b>
026121005E	<b>81522</b>
026121005E	<b>82080</b>
026121005E	<b>82080</b>
026121005F	<b>81526</b>
026121005G	<b>81522</b>
026121005G	<b>82080</b>
026121005G	<b>82080</b>
026121005H	<b>81522</b>
026121005H	<b>82080</b>
026121005H	<b>82080</b>
026121005K	<b>81526</b>
026121010A	<b>82001</b>
026121010AV	<b>82001</b>
026121010C	<b>82080</b>
026121010C	<b>82080</b>
026121010CV	<b>82080</b>
026121010CV	<b>82080</b>
026121010CX	<b>82080</b>
026121010CX	<b>82080</b>
026121010D	<b>82001</b>
026121010DV	<b>82001</b>
026121010DX	<b>82001</b>
026121010E	<b>82080</b>
026121010E	<b>82080</b>
026121010F	<b>82080</b>
026121010F	<b>82080</b>
026121010FV	<b>82080</b>
026121010FV	<b>82080</b>
026121010FX	<b>82080</b>
026121010FX	<b>82080</b>
026121010V	<b>82080</b>
026121010V	<b>82080</b>
026121010X	<b>82080</b>
026121010X	<b>82080</b>
028121004V	<b>81528</b>
028121004X	<b>81528</b>
030121004A	<b>81524</b>



**OES**

**VOLKSWAGEN**

030121004B	<b>81524</b>
030121005D	<b>81527</b>
030121005H	<b>81524</b>
030121005L	<b>81524</b>
030121005LV	<b>81524</b>
030121005LX	<b>81524</b>
030121005N	<b>81527</b>
030121005NV	<b>81527</b>
030121005NX	<b>81527</b>
030121005S	<b>81775</b>
030121008A	<b>81775</b>
030121008AV	<b>81775</b>
030121008AX	<b>81775</b>
030121008C	<b>81775</b>
030121008J	<b>81527</b>
030121008K	<b>81527</b>
030121008M	<b>81527</b>
030121008R	<b>81527</b>
031121004A	<b>81525</b>
031121004AV	<b>81525</b>
031121004AX	<b>81525</b>
031121004V	<b>81525</b>
031121004X	<b>81525</b>
031121005A	<b>81525</b>
031121005C	<b>81525</b>
031121005CV	<b>81525</b>
031121005CX	<b>81525</b>
036121005B	<b>81777</b>
036121005D	<b>81776</b>
036121005DX	<b>81776</b>
036121005E	<b>81777</b>
036121005EV	<b>81777</b>
036121005EX	<b>81777</b>
036121005F	<b>81840</b>
036121005G	<b>81840</b>
036121005GX	<b>81840</b>
036121005M	<b>81776</b>
036121005P	<b>81840</b>
036121005Q	<b>81777</b>
036121005QX	<b>81777</b>
036121005R	<b>81777</b>
036121005S	<b>81777</b>
036121005SV	<b>81777</b>
036121005SX	<b>81777</b>
036121008G	<b>81840</b>

**OES**

**VOLKSWAGEN**

036121008GX	<b>81840</b>
036121008K	<b>81777</b>
036121008L	<b>81777</b>
036121008M	<b>81777</b>
036121008MX	<b>81777</b>
037121005B	<b>81522</b>
037121005C	<b>81522</b>
037121010A	<b>82080</b>
037121010A	<b>82080</b>
037121010AV	<b>82080</b>
037121010AV	<b>82080</b>
037121010AX	<b>82080</b>
037121010AX	<b>82080</b>
037121010B	<b>82080</b>
037121010BX	<b>82080</b>
037121010BX	<b>82080</b>
037121010C	<b>82080</b>
037121010C	<b>82080</b>
037121010CX	<b>82080</b>
038121011A	<b>81706</b>
038121011AV	<b>81706</b>
038121011AX	<b>81706</b>
038121011C	<b>81816</b>
038121011CX	<b>81816</b>
038121011D	<b>81816</b>
038121011DX	<b>81816</b>
038121011G	<b>84011</b>
038121011GX	<b>84011</b>
038121011H	<b>84011</b>
038121011HX	<b>84011</b>
038121011J	<b>84011</b>
038121011JX	<b>84011</b>
038121011K	<b>84011</b>
038121011KX	<b>84011</b>
03C121005B	<b>81865</b>
03C121005C	<b>81865</b>
03C121005D	<b>81865</b>
03C121005DX	<b>81865</b>
03C121005K	<b>81865</b>
03C121005L	<b>81865</b>
03C121005N	<b>82097</b>
03C121005NX	<b>82097</b>
03C121005R	<b>82097</b>
03C121005RX	<b>82097</b>
03C121005S	<b>81865</b>

**OES**

**VOLKSWAGEN**

03C121008B	<b>82097</b>
03C121008BX	<b>82097</b>
03C121008C	<b>81865</b>
03C121008CX	<b>81865</b>
03C121008E	<b>82097</b>
03C121008EX	<b>82097</b>
03C121008F	<b>81865</b>
03C121008FX	<b>81865</b>
03C121008J	<b>81865</b>
03C121008JX	<b>81865</b>
03D121005	<b>81867</b>
03D121005X	<b>81867</b>
03D121013B	<b>81867</b>
03F121004A	<b>84045</b>
03F121004B	<b>84045</b>
03F121004D	<b>84045</b>
03F121005	<b>84045</b>
03G121011	<b>84011</b>
03G121011X	<b>84011</b>
03L121011	<b>84001</b>
03L121011B	<b>81816</b>
03L121011BX	<b>81816</b>
03L121011G	<b>84011</b>
03L121011GX	<b>84011</b>
03L121011H	<b>84001</b>
03L121011J	<b>84001</b>
03L121011P	<b>84001</b>
045121011B	<b>81791</b>
045121011C	<b>84052</b>
045121011F	<b>84010</b>
045121011FX	<b>84010</b>
045121011G	<b>82013</b>
045121011H	<b>84010</b>
045121011HX	<b>84010</b>
045121011J	<b>82013</b>
046121004D	<b>81701</b>
046121004DV	<b>81701</b>
046121004DX	<b>81701</b>
047121013J	<b>81807</b>
04C121600K	<b>84062</b>
04E121600AD	<b>84062</b>
04E121600AG	<b>84062</b>
04E121600AL	<b>84062</b>
04E121600AQ	<b>84062</b>
04E121600AR	<b>84062</b>

OES	MAGNETI MARELLI
<b>VOLKSWAGEN</b>	
04E121600D	84062
04E121600H	84062
04E121600P	84062
050121010A	81529
050121010AV	81529
050121010AX	81529
050121010C	81529
050121010V	81529
050121010X	81529
052121004AV	81520
052121004AX	81520
052121004V	81520
052121004X	81520
052121005A	81520
052121005AX	81520
055121010X	82001
056121005A	81521
056121013A	82001
059121004B	81705
059121004C	81705
059121004CX	81705
059121004D	81705
059121004E	81705
059121004EV	81705
059121004EX	81705
059121005T	84021
059121005TX	84021
059121008A	84021
059121008J	84021
059121008JX	84021
066121011C	81856
066121011CX	81856
066121011D	81856
068121005A	81522
068121005A	82080
068121005A	82080
068121005B	81521
068121005C	81521
068121010A	82080
068121010A	82080
068121010AX	82080
068121010AX	82080
069121004V	81593
069121004X	81593
069121005D	81593

OES	MAGNETI MARELLI
<b>VOLKSWAGEN</b>	
06A121011C	81703
06A121011E	81703
06A121011EV	81703
06A121011EX	81703
06A121011F	81703
06A121011G	81703
06A121011H	81703
06A121011HV	81703
06A121011HX	81703
06A121011L	81703
06A121011LV	81703
06A121011LX	81703
06A121011T	81703
06A121011TX	81703
06A121012	81703
06A121012G	81703
06A121012GX	81703
06A121012X	81703
06B121011	81702
06B121011A	81702
06B121011B	81702
06B121011BV	81702
06B121011BX	81702
06B121011C	81702
06B121011CV	81702
06B121011CX	81702
06B121011E	81702
06B121011EV	81702
06B121011EX	81702
06B121011H	81702
06B121011L	81702
06B121011LX	81702
06B121011M	81702
06B121011N	81702
06B121011NX	81702
06B121011Q	81702
06C121004C	81819
06C121004G	81819
06C121004H	81819
06C121004HX	81819
06E121008N	82015
06E121018A	82015
06F121011	82025
06F121011X	82025
06H121026AB	84016

OES	MAGNETI MARELLI
<b>VOLKSWAGEN</b>	
06H121026AF	84016
06H121026AG	84016
06H121026B	84016
06H121026B	84016
06H121026BA	84016
06H121026BE	84016
06H121026BF	84016
06H121026CC	84016
06H121026CP	84016
06H121026DD	84016
06H121026N	84016
06J121026A	84016
06J121026AG	84016
06J121026F	84016
06J121026G	84016
06K121011	84037
06L121005A	84037
06L121012	84037
06L121012A	84037
070121011A	82033
070121011C	82033
070121011D	82033
070121011DX	82033
073121004V	81833
073121004X	81833
074121004A	81701
074121004AV	81701
074121004AX	81701
074121004BX	81701
074121004N	81701
074121004NX	81701
074121004V	81701
074121004X	81701
074121005MV	81701
074121005N	81701
077121004M	82081
077121004MX	82081
077121004N	82081
077121004PX	82081
078121004H	81842
078121004HX	81842
078121004J	81842
078121004JV	81842
078121004JX	81842
078121004L	81842

<b>OES</b>	<b>MAGNETI MARELLI</b>
------------	------------------------

<b>VOLKSWAGEN</b>	
078121004Q	<b>81842</b>
078121004QX	<b>81842</b>
078121004R	<b>81842</b>
078121006A	<b>81842</b>
078121006X	<b>81842</b>

<b>VOLVO</b>	
270559	<b>81594</b>
270681	<b>81592</b>
271275	<b>81594</b>
271647	<b>82056</b>
271647	<b>82056</b>
271830	<b>81594</b>
271855	<b>82056</b>
271855	<b>82056</b>
271975	<b>81594</b>
271984	<b>81857</b>
271985	<b>82056</b>
271986	<b>82056</b>
271986	<b>82056</b>
272334	<b>81779</b>
272457	<b>82056</b>
272457	<b>82056</b>
272474	<b>82056</b>
272474	<b>82056</b>
272476	<b>82056</b>
272476	<b>82056</b>
272481	<b>82056</b>
272481	<b>82056</b>

<b>OES</b>	<b>MAGNETI MARELLI</b>
------------	------------------------

<b>VOLVO</b>	
272482	<b>81857</b>
274155	<b>81701</b>
274216	<b>81864</b>
275619	<b>81592</b>
463425	<b>81592</b>
1326342	<b>81594</b>
2716132	<b>81593</b>
2716470	<b>82056</b>
2716470	<b>82056</b>
2717684	<b>81701</b>
2719585	<b>82056</b>
2719847	<b>81857</b>
2719854	<b>82056</b>
2719854	<b>82056</b>
2719862	<b>82056</b>
2719862	<b>82056</b>
3242084	<b>81574</b>
3344831	<b>81574</b>
3345626	<b>81574</b>
8653806	<b>81800</b>
8694628	<b>81857</b>
8694630	<b>81864</b>
8694759	<b>81804</b>
12571857	<b>81593</b>
30620725	<b>81814</b>
30650751	<b>82056</b>
30650751	<b>82056</b>
30650979	<b>81864</b>
30684432	<b>82056</b>

<b>OES</b>	<b>MAGNETI MARELLI</b>
------------	------------------------

<b>VOLVO</b>	
30684432	<b>82056</b>
30711527	<b>81869</b>
30711622	<b>81598</b>
30725831	<b>81800</b>
30731312	<b>81804</b>
30735758	<b>81598</b>
30751022	<b>81864</b>
30751700	<b>82056</b>
30751700	<b>82056</b>
30751971	<b>81869</b>
30757405	<b>81804</b>
30777590	<b>81804</b>
30788221	<b>81800</b>
30855991	<b>81574</b>
31219176	<b>82027</b>
31293177	<b>81864</b>
31293668	<b>81864</b>
31319266	<b>81804</b>
31330943	<b>82027</b>
31368353	<b>82027</b>
32877516	<b>81574</b>
33430935	<b>81574</b>
33442518	<b>81574</b>
33448275	<b>81574</b>

<b>YUGO</b>	
4384128	<b>81481</b>
7580756	<b>81481</b>



**Tavole di comparazione IAM**  
**IAM cross reference guide**  
**Gegenüberstellung IAM**  
**Table de correspondance IAM**  
**Tabla de equivalencias IAM**  
**Tabela de equivalências IAM**  
**Πίνακας αντιστοιχιών IAM**  
**Tabela porównawcza IAM**  
**Кросс-таблица с IAM номерами**  
**IAM çarpaz referans tablosu**

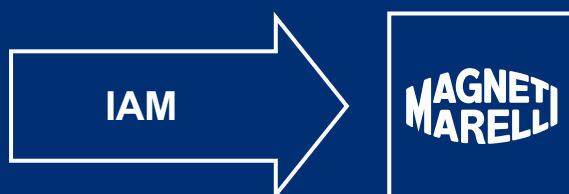



IAM	MAGNETI MARELLI
<b>AIRTEX</b>	
1094	81415
1111	81531
1125	81999
1133	81811
1134	81576
1135	81554
1138	81520
1139	81521
1140	81522
1145	81618
1162	81544
1163	81543
1164	81549
1167	81606
1180	81592
1189	11706T
1190	81593
1193	81822
1195	81574
1196	81498
1197	81536
1198	81436
1208	81552
1209	81671
1212	81797
1212	81556
1217	81434
1218	81586
1219	81584
1222	81443
1225	81460
1227	81532
1228	81602
1229	81538
1236	81506
1241	81664
1242	81828
1243	81608
1247	81594
1288	81481
1294	81605
1296	81616
1303	81683
1307	81587
1308	81617

IAM	MAGNETI MARELLI
<b>AIRTEX</b>	
1310	81672
1312	81458
1321	81477
1327	81314
1338	81525
1348	82080
1348	82080
1349	82001
1359	82023
1359	81512
1364	81650
1366	81661
1368	81613
1369	81590
1370	81589
1371	81588
1377	81450
1382	81611
1383	81490
1385	81619
1386	81508
1388	81684
1391	81685
1391	81687
1394	81507
1395	81302
1397	81524
1398	81614
1399	81615
1400	81654
1404	81653
1406	81509
1412	81322
1415	81656
1417	81597
1419	81513
1420	81353
1421	81367
1423	81300
1424	81324
1426	81315
1427	81325
1428	81339
1429	81365
1429	81304

IAM	MAGNETI MARELLI
<b>AIRTEX</b>	
1430	81476
1431	81333
1432	81303
1435	81657
1437	81334
1438	81332
1442	81722
1443	81499
1444	81723
1446	82005
1447	81550
1448	81551
1449	81666
1450	81854
1451	81756
1452	81759
1453	81757
1454	81758
1455	81667
1456	81853
1457	81596
1457	81854
1458	81855
1459	81843
1460	81707
1465	82056
1465	82056
1480	81833
1510	81772
1512	81715
1513	81714
1515	81742
1523	81801
1525	81755
1527	81660
1530	81527
1533	81316
1537	81743
1541	81329
1543	81842
1544	81341
1545	81331
1550	81746
1552	81750
1555	81366

IAM	MAGNETI MARELLI
<b>AIRTEX</b>	
1556	81341
1556	81364
1557	81343
1558	81348
1559	81764
1562	81651
1563	81711
1564	81710
1567	82053
1568	81722
1572	81463
1572	81347
1572	81363
1573	81464
1573	81326
1574	81309
1575	81456
1576	81342
1577	81578
1578	81579
1579	81642
1580	81713
1581	81777
1582	81775
1583	81776
1584	81760
1585	81762
1586	81716
1587	81752
1588	81702
1588	81703
1589	81320
1591	81318
1592	81856
1593	81319
1594	81362
1595	81352
1595	81330
1596	81705
1597	81774
1598	82087
1599	81526
1600	81753
1601	81712
1602	81340

IAM	MAGNETI MARELLI
<b>AIRTEX</b>	
1602	81351
1603	81369
1606	81749
1608	81529
1609	81522
1610	82080
1610	82080
1611	81469
1616	81370
1618	81573
1619	81802
1622	81844
1625	81839
1626	81368
1627	81346
1628	81301
1630	81793
1631	81781
1632	81780
1633	81782
1634	81726
1635	81728
1636	81729
1637	81767
1638	81768
1640	81761
1641	84039
1641	81806
1642	81751
1643	81747
1645	81795
1646	81783
1647	82084
1648	82088
1649	81794
1651	81362
1659	81804
1685	82048
1688	82034
1733	82021
1746	84007
1894	84015
2300	81491
4084	81655
4085	82004

IAM	MAGNETI MARELLI
<b>AIRTEX</b>	
4104	81598
4115	81803
5029	81789
5048	81790
5058	81858
5079	81846
7115	81784
7135	81731
7150	81733
9099	81770
9150	81832
9209	81613
9209	81708
9212	81786
9213	81736
9214	81744
9251	81709
9262	81773
9272	81769
9274	81701
9279	81700
9312	81724
9314	81725
9335	81528
9367	81771
9374	82050
9377	81703
9378	81816
9378	84011
9378	81706
9419	82039
11271	81572
11301	81334
1088M	81560
1091A	81419
1124D1	81497
1164C	81681
AW9271	81815
PA9306	82051
PA993	82069





<b>AISIN</b>	
WE-SM01A	82049
WN-076	82053
WPH-043	82045
WPH-044	82039
WPK001	82038
WPM-002	81787
WPM-045	81731
WPN-008	82054
WPT-057	82051
WPT-118	82044
WPT-140	84030
WPT-164	84031
WPT-170	84028
WPT-180	84029
WPT-181	84032
WPT-910A	82048
WPT-912	82063
WPT-912	82063
WPY-006	82021
WPY-020	82020
WPY-021	81785
WPY-033	84015
WT902	82048

<b>ASHIKA</b>	
35-02-203	82051
35-02-274	84030
35-02-275	84031
35-02-276	82048
35-02-283	82044
35-04-436	82039
35-04-439	82045
35-0H-H03	84018
35-0H-H12	84059
35-0K-K16	84058
35-K0-002	82038

<b>BUGATTI</b>	
PA0010	81415
PA0011S	81481
PA0018	81434
PA0026	81822
PA0030	81492
PA0035	81443
PA0039	81491



<b>BUGATTI</b>	
PA0040	81999
PA0042	81619
PA0055	81552
PA0056	81671
PA0057	81572
PA0071	81554
PA0091	81543
PA0092	81544
PA0099	81549
PA0105	81560
PA0142	81504
PA0145	81507
PA0146	81506
PA0186	81828
PA0188	81576
PA0189	81573
PA0190	81664
PA0195	81608
PA0207	81618
PA0209	81584
PA0211	81586
PA0212	81616
PA0213	81617
PA0214	81587
PA0226	81532
PA0231	81531
PA0239	81536
PA0240	81602
PA0243	81538
PA0246	81650
PA0247	81651
PA0252T	81419
PA0273	11701T
PA0274	11707
PA0280	81460
PA0285	81594
PA0290	81592
PA0308	81611
PA0313	81520
PA0317	81593
PA0319	81522
PA0319C	82080
PA0320	81521
PA0320C	82001
PA0323	81832



<b>BUGATTI</b>	
PA0325	81683
PA0327	81833
PA0363	81498
PA0506	81450
PA0507	81456
PA0508	81458
PA0509	81469
PA0513	81476
PA0513S	81314
PA0515	81463
PA0516	81464
PA0516S	81326
PA0517	81309
PA0519	81477
PA0527	81436
PA10001	81815
PA10002	81816
PA10005	81819
PA10006	81814
PA10007	81834
PA10008	81835
PA10010	81820
PA10011	81810
PA10012	81797
PA10013	81798
PA10014	81836
PA10015	82010
PA10016	82040
PA10017	81872
PA10018	84004
PA10019	81817
PA10020	81818
PA10021	82081
PA10023	82082
PA10025	81861
PA10026	84012
PA10028	82029
PA10029	81821
PA10030	82011
PA10031	81862
PA10033	82083
PA10034	81837
PA10035	81838
PA10036	81839
PA10037	82084

<b>IAM</b>	
------------	--

<b>BUGATTI</b>	
PA10039	<b>82056</b>
PA10040	<b>81864</b>
PA10042	<b>81840</b>
PA10043	<b>81865</b>
PA10044	<b>81866</b>
PA10045	<b>81867</b>
PA10047	<b>82055</b>
PA10048	<b>82012</b>
PA10049	<b>82013</b>
PA10051	<b>81868</b>
PA10052	<b>81869</b>
PA10053	<b>82023</b>
PA10055	<b>82028</b>
PA10056	<b>84061</b>
PA10057	<b>82014</b>
PA10058	<b>82026</b>
PA10060	<b>82015</b>
PA10061	<b>82046</b>
PA10063	<b>82016</b>
PA10064	<b>82017</b>
PA10065	<b>82025</b>
PA10066	<b>82085</b>
PA10073	<b>82018</b>
PA10074	<b>82047</b>
PA10075	<b>82090</b>
PA10076	<b>82022</b>
PA10077	<b>82024</b>
PA10078	<b>82030</b>
PA10079	<b>82091</b>
PA10080	<b>82041</b>
PA10081	<b>82038</b>
PA10082	<b>82033</b>
PA10085	<b>84013</b>
PA10086	<b>82034</b>
PA10087	<b>82063</b>
PA10088	<b>82032</b>
PA10090	<b>82052</b>
PA10091	<b>82092</b>
PA10092	<b>84060</b>
PA10093	<b>82093</b>
PA10094	<b>82071</b>
PA10095	<b>82057</b>
PA10096	<b>82048</b>
PA10098	<b>82042</b>
PA10099	<b>84058</b>

<b>IAM</b>	
------------	--

<b>BUGATTI</b>	
PA10102	<b>82020</b>
PA10103	<b>82021</b>
PA10104	<b>82049</b>
PA10105	<b>84057</b>
PA10106	<b>82036</b>
PA10107	<b>82027</b>
PA10108	<b>82050</b>
PA10109	<b>82058</b>
PA10110	<b>82059</b>
PA10111	<b>82066</b>
PA10114	<b>82068</b>
PA10115	<b>82053</b>
PA10116	<b>82054</b>
PA10117	<b>82069</b>
PA10118	<b>84014</b>
PA10119	<b>84015</b>
PA10121	<b>84059</b>
PA10124	<b>82051</b>
PA10125	<b>82094</b>
PA10126	<b>82095</b>
PA10127	<b>82044</b>
PA10129	<b>82045</b>
PA10131	<b>82039</b>
PA10134	<b>84000</b>
PA10135	<b>82040</b>
PA10138	<b>82056</b>
PA10139	<b>84016</b>
PA10140	<b>84016</b>
PA10141	<b>82097</b>
PA10142	<b>82067</b>
PA10145	<b>82098</b>
PA10146	<b>82099</b>
PA10147	<b>84017</b>
PA10148	<b>84001</b>
PA10151	<b>84018</b>
PA10153	<b>82070</b>
PA10154	<b>82089</b>
PA10156	<b>82063</b>
PA10161	<b>82080</b>
PA10169	<b>84019</b>
PA10170	<b>84020</b>
PA10178	<b>84021</b>
PA10179	<b>84022</b>
PA10180	<b>84023</b>
PA10182	<b>84024</b>

<b>IAM</b>	
------------	--

<b>BUGATTI</b>	
PA10183	<b>84001</b>
PA10184	<b>81872</b>
PA10185	<b>84025</b>
PA10187	<b>84002</b>
PA10189	<b>84026</b>
PA10190	<b>84003</b>
PA10191	<b>84027</b>
PA10192	<b>84004</b>
PA10193	<b>84028</b>
PA10195	<b>84029</b>
PA10196	<b>84030</b>
PA10197	<b>84005</b>
PA10202	<b>84031</b>
PA10203	<b>84032</b>
PA10204	<b>84006</b>
PA10205	<b>84009</b>
PA10209	<b>84007</b>
PA10212	<b>84033</b>
PA10213	<b>84008</b>
PA10216	<b>84034</b>
PA10220	<b>84035</b>
PA10223	<b>84036</b>
PA10225	<b>84037</b>
PA10227	<b>84010</b>
PA10228	<b>84011</b>
PA10231	<b>84062</b>
PA10233	<b>84038</b>
PA10234	<b>82089</b>
PA10235	<b>84039</b>
PA10236	<b>84040</b>
PA10239	<b>84042</b>
PA10240	<b>84065</b>
PA10245	<b>84063</b>
PA10247	<b>84064</b>
PA10248	<b>84043</b>
PA10249	<b>84044</b>
PA10253	<b>84045</b>
PA10254	<b>84046</b>
PA10255	<b>84047</b>
PA10256	<b>84048</b>
PA10257	<b>82095</b>
PA10264	<b>84049</b>
PA10265	<b>84050</b>
PA10266	<b>84051</b>
PA10267	<b>84052</b>

<b>IAM</b>	<b>MAGNETI MARELLI</b>
------------	------------------------

<b>BUGATTI</b>	
PA10269	<b>84053</b>
PA10271	<b>84054</b>
PA1053	<b>81512</b>
PA1080	<b>81606</b>
PA1081	<b>81605</b>
PA1082	<b>81681</b>
PA1084	<b>81684</b>
PA1171	<b>81660</b>
PA1172	<b>81661</b>
PA1262	<b>19532/E</b>
PA5001	<b>81302</b>
PA5002	<b>11701T</b>
PA5003	<b>11708T</b>
PA5006	<b>11706T</b>
PA5007	<b>81322</b>
PA5009	<b>81331</b>
PA5010	<b>81348</b>
PA5011	<b>81355</b>
PA5013	<b>81352</b>
PA5014	<b>81362</b>
PA5102	<b>81700</b>
PA5107	<b>81529</b>
PA5108	<b>81528</b>
PA5109	<b>81526</b>
PA5110	<b>81842</b>
PA5112	<b>81702</b>
PA5113	<b>81703</b>
PA5114	<b>81706</b>
PA5115	<b>81705</b>
PA5116	<b>81706</b>
PA5117	<b>81842</b>
PA5201	<b>81613</b>
PA5202	<b>81614</b>
PA5203	<b>81615</b>
PA5204	<b>81707</b>
PA5205	<b>81708</b>
PA5206	<b>81709</b>
PA5207	<b>81843</b>
PA5401	<b>81588</b>
PA5402	<b>81589</b>
PA5403	<b>81590</b>
PA5404	<b>81597</b>
PA5413	<b>81796</b>
PA5414	<b>81793</b>
PA5418	<b>81795</b>

<b>IAM</b>	<b>MAGNETI MARELLI</b>
------------	------------------------

<b>BUGATTI</b>	
PA5419	<b>81794</b>
PA5501	<b>81642</b>
PA5502	<b>81672</b>
PA5504	<b>81556</b>
PA5505	<b>81710</b>
PA5506	<b>81711</b>
PA5507	<b>81844</b>
PA5508	<b>81712</b>
PA5509	<b>81713</b>
PA5510	<b>81799</b>
PA5702	<b>81714</b>
PA5704	<b>81715</b>
PA5903	<b>81488</b>
PA5904	<b>81489</b>
PA5907	<b>81315</b>
PA5908	<b>81300</b>
PA5909	<b>81324</b>
PA5911	<b>81325</b>
PA5912	<b>81339</b>
PA5913	<b>81303</b>
PA5914	<b>81365</b>
PA5915	<b>81304</b>
PA5916	<b>81333</b>
PA5919	<b>81334</b>
PA5920	<b>81332</b>
PA5922	<b>81316</b>
PA5923	<b>81340</b>
PA5924	<b>81341</b>
PA5925	<b>81364</b>
PA5926	<b>81329</b>
PA5927	<b>81330</b>
PA5928	<b>81342</b>
PA5929	<b>81372</b>
PA5930	<b>81347</b>
PA5931	<b>81363</b>
PA5932	<b>81346</b>
PA5933	<b>81368</b>
PA5934	<b>81369</b>
PA5935	<b>81351</b>
PA5936	<b>81301</b>
PA5937	<b>81343</b>
PA5938	<b>81366</b>
PA5939	<b>81320</b>
PA5940	<b>81318</b>
PA5941	<b>81319</b>

<b>IAM</b>	<b>MAGNETI MARELLI</b>
------------	------------------------

<b>BUGATTI</b>	
PA5942	<b>81370</b>
PA5943	<b>81369</b>
PA5944	<b>81344</b>
PA5945	<b>81801</b>
PA5946	<b>82086</b>
PA6001	<b>81653</b>
PA6002	<b>81654</b>
PA6003	<b>81559</b>
PA6004	<b>81655</b>
PA6005	<b>81656</b>
PA6006	<b>81657</b>
PA6009	<b>82004</b>
PA6010	<b>81598</b>
PA6011	<b>81716</b>
PA6012	<b>81802</b>
PA6013	<b>81803</b>
PA6014	<b>81845</b>
PA6015	<b>81804</b>
PA6016	<b>81805</b>
PA6401	<b>81717</b>
PA6501	<b>81490</b>
PA6804	<b>81508</b>
PA6805	<b>81509</b>
PA6808	<b>81499</b>
PA6811	<b>81722</b>
PA6814	<b>81723</b>
PA6816	<b>81724</b>
PA6818	<b>81725</b>
PA6819	<b>81726</b>
PA6820	<b>82087</b>
PA6821	<b>81728</b>
PA6822	<b>81729</b>
PA6823	<b>81730</b>
PA6824	<b>82088</b>
PA6905	<b>81731</b>
PA6908	<b>81733</b>
PA7103	<b>81736</b>
PA7109	<b>81742</b>
PA7110	<b>81743</b>
PA7111	<b>81744</b>
PA7112	<b>81745</b>
PA7201	<b>81685</b>
PA7202	<b>81550</b>
PA7203	<b>81551</b>
PA7204	<b>82005</b>

IAM	MAGNETI MARELLI
<b>BUGATTI</b>	
PA7205	81687
PA7207	81746
PA7208	81747
PA7209	81846
PA7210	81748
PA7211	81749
PA7212	81750
PA7213	81751
PA7214	81847
PA7217	81812
PA7402	81367
PA7404	81513
PA7405	81353
PA7406	81752
PA7407	81753
PA7409	81800
PA7410	81813
PA7701	81574
PA7702	81754
PA7703	81666
PA7704	81667
PA7705	81755
PA7707	81851
PA7708	81596
PA7709	81756
PA7710	81757
PA7711	81758
PA7712	81759
PA7713	81760
PA7714	81579
PA7715	81578
PA7716	81761
PA7717	81762
PA7718	81806
PA7719	81852
PA7721	81811
PA7722	81853
PA7723	81854
PA7724	81855
PA7802	81764
PA7902	81497
PA8501	81766
PA8502	81767
PA8503	81768
PA8504	81769

IAM	MAGNETI MARELLI
<b>BUGATTI</b>	
PA8505	81770
PA8506	81771
PA8507	81808
PA8508	81809
PA8701	81772
PA8702	81524
PA8703	81525
PA8704	81527
PA8705	81773
PA8706	81774
PA8707	81775
PA8708	81856
PA8709	81776
PA8710	81777
PA8711	81807
PA8712	81791
PA8713	81701
PA8802	81857
PA8803	82056
PA8804	81779
PA9101	81780
PA9102	81781
PA9103	81782
PA9104	81783
PA9201	81784
PA9202	81785
PA9203	81786
PA9204	81787
PA9301	81789
PA9302	81790
PA9303	81858

<b>DELPHI</b>	
WP1103	81552
WP1106	81671
WP1906	82053
WP2462	82051
WP2477	82048
WP2529	82057

<b>DOLZ</b>	
A130	81302
A133	11706T
A145	11701T
A145	11701T

IAM	MAGNETI MARELLI
<b>DOLZ</b>	
A146	11707
A148	19532/E
A149	11708T
A150	81521
A151	81522
A154	81593
A158	81683
A159	81520
A160	82001
A161	82080
A161	82080
A162	81833
A164	81524
A167	81832
A168	81525
A171	81700
A191	81777
A192	81856
A197	84052
A210	82033
A212	82025
A221	84016
A222	84001
A222	84001
A230	81362
A241	81362
A250	82013
B114	81332
B204	81618
B206	81586
B207	81584
B211	81617
B212	81616
B213	81587
B214	81588
B215	81589
B216	81590
B219	81597
B220	81794
B226	82034
C110	81556
C111	81513
C112	81353
C113	81753
C115	81822

IAM	MAGNETI MARELLI
<b>DOLZ</b>	
C117	81642
C120	81713
C121	81844
C122	81798
C123	82042
C123	81813
C124	81799
C130	81752
C137	82067
C138	82089
C138	84038
C138	82089
C144	81799
C145	82068
F105	81531
F111	81532
F112	81602
F114	81559
F115	81536
F125	81655
F126	82004
F127	81538
F131	81654
F135	81651
F137	81650
F141	81803
F145	81657
F147	81653
F148	82057
F150	81804
F200	81764
F201	81802
F203	82018
H117	81611
H133	82039
H200	81784
H203	81785
H226	84015
I170	82024
I274	82095
I274	82095
L120	81999
L121	81619
L135	81460
L155	81490

IAM	MAGNETI MARELLI
<b>DOLZ</b>	
M131	81419
M142	81614
M143	81615
M144	81613
M145	81707
M174	81507
M175	81504
M176	81506
M179	81509
M189	81508
M212	81730
M213	82087
M215	82030
M221	82047
M-244	82092
M276	81726
N110	81744
N111	81736
N120	82054
N130	82053
N206	81672
N304	81671
N305	81552
N405	81512
O104	81544
O105	81543
O106	81549
O116	81681
O117	81606
O118	81605
O129	81684
O130	81685
O136	82005
O137	81551
O138	81550
O142	84005
O160	81751
O266	84014
R119	81572
R122	81828
R124	81661
R125	81664
R129	81573
R131	81608
R131	81666

IAM	MAGNETI MARELLI
<b>DOLZ</b>	
R133	81754
R137	81667
R140	81325
R144	81756
R163	81660
R164	81759
R165	81757
R178	81576
R179	81574
R193	81592
R196	81594
R216	84039
R216	81806
R227	84007
R231	84007
S103	81415
S103	81300
S125	81458
S134	81352
S135	81481
S138	81333
S141	81443
S146	81476
S148	81434
S150	81491
S151	81334
S153	81498
S155	81436
S157	81492
S160	81324
S164	81497
S165	81309
S166	81477
S168	81488
S170	81450
S172	81469
S181	81463
S182	81456
S184	81489
S226	81366
S231	81351
S320	82070
T116	81560
T136	81554
T224	82048

<b>IAM</b>	<b>MAGNETI MARELLI</b>
------------	------------------------

<b>FEBI BILSTEIN</b>	
----------------------	--

15947	<b>82056</b>
17130	<b>82030</b>
22251	<b>81804</b>
26279	<b>82021</b>
26393	<b>82052</b>

<b>GERI</b>	
-------------	--

317102	<b>81804</b>
317106	<b>82057</b>
317108	<b>82018</b>
321166	<b>82024</b>
326004	<b>81552</b>
327134	<b>82054</b>
327150	<b>82053</b>
329144	<b>82048</b>
350112	<b>82030</b>
350114	<b>82047</b>

<b>GGT</b>	
------------	--

PA10039	<b>82051</b>
PA12506	<b>82039</b>
PA12523	<b>82095</b>
PA12523	<b>82095</b>
PA12541	<b>82067</b>
PA12549	<b>82070</b>
PA12555	<b>82068</b>
PA12562	<b>84016</b>
PA12564	<b>84001</b>
PA12564	<b>84001</b>

<b>GK</b>	
-----------	--

680293	<b>84001</b>
680293	<b>84001</b>
980107	<b>82056</b>
980262	<b>82033</b>
980273	<b>82041</b>
980481	<b>82047</b>
980494	<b>82030</b>
980501	<b>82034</b>
980753	<b>84005</b>
980773	<b>81804</b>
980776	<b>82018</b>
980778	<b>84027</b>
980817	<b>84000</b>
980901	<b>82049</b>

<b>IAM</b>	<b>MAGNETI MARELLI</b>
------------	------------------------

<b>GK</b>	
-----------	--

981034	<b>82024</b>
981201	<b>82070</b>
981734	<b>82054</b>
981736	<b>82053</b>
986807	<b>82068</b>
986809	<b>82067</b>
987515	<b>82050</b>
987691	<b>82063</b>
987691	<b>82063</b>
987733	<b>84015</b>
987766	<b>82020</b>
987768	<b>82021</b>
987769	<b>82044</b>
987772	<b>82022</b>
987793	<b>82048</b>
987802	<b>84032</b>
987812	<b>82039</b>
987832	<b>82045</b>
987980	<b>82038</b>

<b>GP</b>	
-----------	--

PA1333	<b>84015</b>
PA1367	<b>84014</b>

<b>GRAF</b>	
-------------	--

PA088	<b>81415</b>
PA095	<b>81552</b>
PA098	<b>11706T</b>
PA1001	<b>82071</b>
PA10036	<b>81837</b>
PA1006	<b>82052</b>
PA101	<b>11706T</b>
PA1013	<b>82093</b>
PA1019	<b>82056</b>
PA102	<b>81593</b>
PA1020	<b>82063</b>
PA1020	<b>82063</b>
PA1021	<b>84018</b>
PA1023	<b>84058</b>
PA1024	<b>82021</b>
PA1026	<b>82094</b>
PA1030	<b>82070</b>
PA1035	<b>81579</b>
PA1039	<b>84000</b>
PA1046	<b>82034</b>

<b>IAM</b>	<b>MAGNETI MARELLI</b>
------------	------------------------

<b>GRAF</b>	
-------------	--

PA1052	<b>84017</b>
PA1053	<b>81795</b>
PA1056	<b>84033</b>
pa1068	<b>84014</b>
PA1075	<b>84024</b>
PA1076	<b>84043</b>
PA108	<b>81544</b>
PA1085	<b>81872</b>
PA1086	<b>84032</b>
PA1087	<b>84009</b>
PA1088	<b>84015</b>
PA1089	<b>84001</b>
PA1089	<b>84001</b>
PA1090	<b>84011</b>
PA1093	<b>84028</b>
PA1094	<b>84031</b>
PA1097	<b>84006</b>
PA1107	<b>84004</b>
PA1109	<b>84002</b>
PA1125	<b>84040</b>
PA113	<b>81828</b>
PA1134	<b>84030</b>
PA114	<b>81592</b>
PA1141	<b>84021</b>
PA117	<b>81602</b>
PA1185	<b>84034</b>
PA1189	<b>84026</b>
PA1197	<b>84025</b>
PA1246	<b>84037</b>
PA131	<b>81532</b>
PA146	<b>81521</b>
PA147	<b>81572</b>
PA148	<b>81520</b>
PA153	<b>81531</b>
PA154	<b>81671</b>
PA159	<b>81434</b>
PA197	<b>81560</b>
PA240	<b>81822</b>
PA243	<b>81586</b>
PA247	<b>81576</b>
PA256	<b>81554</b>
PA264	<b>81584</b>
PA275	<b>81492</b>
PA278	<b>81536</b>
PA279	<b>81522</b>

IAM	MAGNETI MARELLI
<b>GRAF</b>	
PA286a	81801
PA293	81443
PA295	81602
PA298	81460
PA304	81498
PA306	11707
PA312	81594
PA317	81491
PA318	81450
PA321	81538
PA323	81559
PA324	81605
PA325	81606
PA328	81556
PA338a	81456
PA340	81469
PA344	81832
PA346	19532/E
PA348	81512
PA353	81660
PA354	81458
PA365	81464
PA369	81616
PA370	81617
PA372	81477
PA378A	81309
PA380	81618
PA381	11701T
PA383	81683
PA384	81833
PA385	81611
PA390	81587
PA391	81642
PA393	81672
PA397	81460
PA398	81476
PA399	81490
PA401	81650
PA404	81619
PA406	81508
PA410	81684
PA412	81661
PA415	81685
PA418	81436
PA420	81302

IAM	MAGNETI MARELLI
<b>GRAF</b>	
PA423	81525
PA424	81772
PA425	81524
PA426	81614
PA427	81615
PA428	81613
PA429	81654
PA430	81590
PA431	81589
PA432	81588
PA440	81653
PA441	81543
PA442	81549
PA443	81681
PA444	81489
PA446	81504
PA448	81506
PA449	81507
PA451	81300
PA452	81324
PA454	81488
PA491	81513
PA493a	81744
PA494	11708T
PA495	81509
PA496	81322
PA497	81315
PA499	81334
PA500	81332
PA501	81655
PA502	81597
PA503	81325
PA508	81736
PA509	82004
PA513	81755
PA514	81666
PA515	81851
PA516	81754
PA517	81602
PA527	81664
PA529	81596
PA530	81756
PA531	81574
PA532	81759
PA533	81757

IAM	MAGNETI MARELLI
<b>GRAF</b>	
PA534	81758
PA536	81667
PA537	81742
PA541	82005
PA541A	81817
PA542	81353
PA543	81608
PA544	81367
PA546	82001
PA550	81573
PA552	81339
PA553	81304
PA554	81481
PA555	81715
PA556	81714
PA557	11701T
PA559	81434
PA561	81843
PA562	81707
PA563	81708
PA564	81709
PA571	81687
PA572	81550
PA573	81828
PA575	81999
PA577	81551
PA579	82080
PA579	82080
PA580	81722
PA582	81499
PA583	81723
PA584	81724
PA587	81419
PA589	81657
PA590	81656
PA591	81700
PA594	81853
PA595	81811
PA597	81854
PA598	81314
PA599	81333
PA601	81303
PA603	81527
PA605A	81347
PA607	81316

IAM	MAGNETI MARELLI
<b>GRAF</b>	
PA609	81528
PA610	81724
PA611	81743
PA612	81598
PA614	81340
PA615	81330
PA616	81329
PA617	81773
PA618A	81842
PA620	81364
PA621	81331
PA622	81342
PA624	81463
PA626	81366
PA627	81760
PA628	81556
PA629	81341
PA630	81343
PA631	81348
PA632	81762
PA633	81578
PA635	82054
PA636	81764
PA637	81846
PA639	81716
PA640	81651
PA641	81711
PA642	81710
PA643	81752
PA644	81702
PA645	81320
PA646	81319
PA647	81318
PA653	81844
PA654	81776
PA655	81703
PA658	81856
PA660	82053
PA661	81722
PA664	81746
PA664	81847
PA665	81750
PA666	81857
PA667	81347
PA669	81838

IAM	MAGNETI MARELLI
<b>GRAF</b>	
PA670	81839
PA671	81362
PA672	81352
PA673	81355
PA674	81777
PA675	81705
PA676	81775
PA677	81774
PA678	82087
PA679	81526
PA683	81753
PA684	81712
PA685	81346
PA686	81346
PA687	81725
PA688	81733
PA689	81301
PA690	81351
PA692	81793
PA693	81369
PA693	81369
PA694	81781
PA695	81780
PA696	81782
PA697	81784
PA698	81785
PA700	81787
PA702	81786
PA703	81745
PA704	81717
PA706	81726
PA708	81728
PA709	81729
PA710	81730
PA712	81766
PA713	81767
PA715	81770
PA717	81769
PA718	81771
PA719	81768
PA721	81852
PA723	81761
PA724	84039
PA724	81806
PA724A	84039

IAM	MAGNETI MARELLI
<b>GRAF</b>	
PA725	81789
PA726	81790
PA727	81751
PA728	81748
PA729	81749
PA730	81747
PA731	81706
PA733	81344
PA736	82087
PA737	81796
PA738	81783
PA739	81370
PA741	81803
PA742	81802
PA746	82084
PA747	81713
PA749	82056
PA749	82056
PA749	82056
PA750	81834
PA751	81835
PA752	82088
PA758	81701
PA759	81794
PA761	84010
PA761	81791
PA762	81816
PA762	84011
PA763	81842
PA764	82081
PA765	81840
PA773	81858
PA779	81529
PA799	81731
PA802	81362
PA803	81855
PA804	81807
PA806	84052
PA816	82038
PA819	84012
PA820	81820
PA821	81810
PA822	81814
PA823	82023
PA824	81864



IAM	MAGNETI MARELLI
<b>GRAF</b>	
PA826	81808
PA827	82048
PA829	82085
PA830	82028
PA832	82057
PA834	81836
PA836	82034
PA837	81797
PA839	81805
PA855	81867
PA859	81798
PA860	81861
PA861	81800
PA862	81799
PA863	81799
PA864	81809
PA865	81779
PA866	81369
PA868	81705
PA875	82013
PA876	82039
PA878	81816
PA878	84011
PA879	84010
PA879	81791
PA880	82086
PA881	81819
PA882	82014
PA884	82029
PA885	84004
PA886	81813
PA887	81862
PA888	82047
PA890	81821
PA893	82010
PA900	82024
PA901	81872
PA902	82018
PA903	81804
PA905	81816
PA905	84011
PA906	81813
PA907	81868
PA908	82030
PA909	82082

IAM	MAGNETI MARELLI
<b>GRAF</b>	
PA912	82055
PA919	82012
PA926	82050
PA938	81869
PA940	81818
PA941	82016
PA946	82026
PA949	82045
PA950	82020
PA956	82036
PA958	82011
PA959	82083
PA960	82042
PA961	82044
PA962	84060
PA965	82040
PA965	82040
PA967	82095
PA967	82095
PA972	81785
PA973	82092
PA974	81845
PA978	82017
PA979	82015
PA980	82025
PA981	82091
PA982	82033
PA983	82090
PA985	84013
PA986	82049
PA990	82027
PA991	84057
PA992	82058
PA993	82059
PA994	82032
PA996	82066
PA1239	84066
<b>HEPU</b>	
P014	11701T
P015	81322
P017	81315
P022	11706T
P0243	82080
P0243	82080

IAM	MAGNETI MARELLI
<b>HEPU</b>	
P028	81443
P045	81615
P046	81613
P051	81592
P053	81594
P054	81574
P056	82056
P056	81857
P056	82056
P061	81779
P064	81456
P065	81434
P065S	81434
P068	81304
P070	81415
P072	81481
P080	81419
P081	81436
P088	81300
P094	81801
P099	81460
P100	81339
P100	81333
P1012	81331
P1015	81318
P102	81463
P103	81464
P1033	81364
P1034	82024
P1035	81351
P1042	81316
P1045	81329
P1049	81347
P1055	81352
P1061	81469
P109	81458
P115	81476
P1155	81334
P1157	81491
P1161	81332
P119	81488
P1201	82070
P122	81303
P123	81303
P125	81314

IAM	MAGNETI MARELLI
<b>HEPU</b>	
P127	81369
P127	81369
P131	82049
P131	82088
P133	81773
P134	82030
P136	81726
P139	82047
P140	82087
P142	81725
P143	81774
P144	81728
P145	81729
P147	81730
P160	81504
P161	81723
P162	81722
P163	81722
P164	81722
P165	81509
P176	81506
P177	81507
P188	81499
P190	81508
P191	81722
P192	81722
P193	81722
P194	81724
P195	81724
P196	81724
P197	81724
P201	81538
P202	81559
P204	81650
P206	81532
P215	81531
P220	81654
P221	82004
P222	81653
P224	81655
P227	81651
P228	81657
P230	81656
P232	81716
P234	81773

IAM	MAGNETI MARELLI
<b>HEPU</b>	
P235	81598
P236	81803
P237	81802
P242	81522
P244	81302
P245	81362
P248	82057
P251	81804
P254	82018
P297	81536
P298	81602
P299	81602
P310	81684
P313	81685
P314	81551
P317	82005
P320	81846
P322	81749
P326	84005
P327	81751
P331	81812
P333	81687
P338	81605
P341	81746
P342	81748
P343	81750
P345	81362
P362	81597
P369	84014
P371	84027
P384	81544
P387	81543
P388	81681
P398	81606
P421	84000
P457	81618
P458	81616
P459	81587
P463	81793
P464	81796
P464	81795
P465	81584
P467	82034
P470	81590
P471	81589

IAM	MAGNETI MARELLI
<b>HEPU</b>	
P472	81588
P474	81617
P475	81586
P509	81498
P514	81521
P515	81520
P516	82001
P517	81833
P518	81526
P519	81529
P521	81525
P524	81773
P527	81593
P528	81772
P532	81832
P533	81524
P534	81683
P535	81700
P536	81701
P540	81527
P541	81775
P542	81528
P543	81774
P544	81842
P545	81702
P547	81703
P549	81706
P556	81776
P557	81777
P559	81705
P571	81856
P576	82033
P587	82025
P606	81764
P607	81747
P608	81760
P620	81999
P622	81619
P623	81513
P624	81717
P655	84001
P655	84001
P736	82053
P741	81736
P748	81743

IAM	MAGNETI MARELLI
<b>HEPU</b>	
P749	81742
P7515	82050
P7691	82063
P7691	82063
P7732	81787
P7733	84015
P7740	81731
P7766	82020
P7768	82021
P7769	82044
P777	81613
P7772	82022
P7793	82048
P7802	84032
P7812	82039
P7832	82045
P791	81781
P792	81549
P793	81780
P795	81782
P796	81550
P7980	82038
P799	81783
P807	82068
P809	82067
P812	81513
P813	81556
P814	81572
P815	81512
P815	81672
P816	81554
P817	81755
P819	81666
P820	81758
P821	81560
P822	81851
P823	81667
P824	81754
P832	81596
P836	81642
P837	81759
P838	81712
P843	81353
P844	81346
P847	81346

IAM	MAGNETI MARELLI
<b>HEPU</b>	
P848	81608
P868	81671
P870	81596
P871	81512
P876	81573
P876	81811
P891	81753
P895	81711
P914	81828
P917	81760
P927	81576
P930	81661
P931	81578
P935	81664
P940	81761
P942	81660
P954S	84024
P962	84007

<b>HERTH+ BUSS JAKOPARTS</b>	
J1510323	82020
J1510529	84018
J1511065	82053
J1512086	82048
J1512092	82022
J1512092	82044
J1512115	82051
J1513060	84060
J1514039	82039
J1514042	82045
J1515065	82049
J1518010	82050

<b>JAPANPARTS</b>	
PQ-203	82051
PQ-274	84030
PQ-275	84031
PQ-276	82048
PQ-283	82044
PQ-436	82039
PQ-439	82045
PQ-921	84033
PQ-H03	84018
PQ-H05	81785

IAM	MAGNETI MARELLI
<b>JAPANPARTS</b>	
PQ-H12	84059
PQ-K02	82038
PQ-K04	84015
PQ-K16	84058
PQ-KI15	82020

<b>JWP</b>	
HW-1049	82021
HW-1053	82020
HW-1843	82045
HW-2838	82039
KW-1606	82038
MW-1457	82049
NW-1249	82053
NW-3207	82054
SW-1916	82050
TW-1155	82051
TW1192	82022
TW-5105	82048

<b>KAGER</b>	
330621	82030
330624	82047
330684	82024
33-0339	82053
33-0418	82056
33-0477	82048
33-0481	82034
33-0643	82050
33-0687	82039
33-0715	82045
33-1042	82095
33-1042	82095
33-1052	84033
33-1060	84032

<b>KAVO PARTS</b>	
TW-5148	84028
TW-5154	84032

<b>KWP</b>	
10098	11706T
10154	81671
10635	82054
10660	82053

IAM	MAGNETI MARELLI
<b>KWP</b>	
10749	82056
10799	81731
10816	82038
10827	82048
10832	82057
10836	82034
10876	82039
10888	82047
10900	82024
10902	82018
10903	81804
10908	82030
10926	82050
10950	82020
10956	82036
10960	82042
10961	82044
10962	84060
10967	82095
10967	82095
10980	82025
10981	82091
10982	82033
10983	82090
10985	84013
10986	82049
10991	84057
10992	82058
10993	82059
10994	82032
10996	82066
100972	81785
100973	82092
101001	82071
101006	82052
101013	82093
101019	82056
101020	82063
101020	82063
101023	84058
101024	82021
101026	82094
101030	82070
101039	84000
101046	82034

IAM	MAGNETI MARELLI
<b>KWP</b>	
101052	84017
101056	84033
101068	84014
101075	84024
101081	81872
101086	84032
101087	84009
101088	84015
101089	84001
101089	84001
101093	84028
101094	84031
101097	84006
101107	84004
101109	84002
10-946	82026
PA195	81552
<b>LPR</b>	
WP0429	82056
WP0449	84007
WP0740	82070
<b>METELLI</b>	
240095	81552
240154	81671
240888	82047
240900	82024
240902	82018
240908	82030
240946	82026
240981	82091
240983	82090
24-0635	82054
24-0660	82053
24-0700	81787
24-0749	82056
24-0816	82038
24-0827	82048
24-0832	82057
24-0836	82034
24-0876	82039
24-0903	81804
24-0926	82050
24-0950	82020

IAM	MAGNETI MARELLI
<b>METELLI</b>	
24-0956	82036
24-0960	82042
24-0961	82044
24-0962	84060
24-0967	82095
24-0967	82095
24-0973	82092
24-098	11706T
24-0980	82025
24-0982	82033
24-0985	84013
24-0986	82049
24-0991	84057
24-0992	82058
24-0993	82059
24-0994	82032
24-0996	82066
24-1001	82071
24-1006	82052
24-1013	82093
24-1019	82056
24-1020	82063
24-1020	82063
24-1023	84058
24-1024	82021
24-1026	82094
24-1030	82070
24-1039	84000
24-1046	82034
24-1052	84017
24-1056	84033
24-1068	84014
24-1075	84024
24-1081	81872
24-1086	84032
24-1087	84009
24-1088	84015
24-1089	84001
24-1089	84001
24-1093	84028
24-1094	84031
24-1097	84006
24-1107	84004
24-1109	84002
24-799	81731

**IAM**

**METELLI**

24-830	<b>82028</b>
24-972	<b>81785</b>

**MEYLE**

0132200001	<b>82030</b>
0132200003	<b>82047</b>
0132200001HD	<b>82030</b>
113 220 0005	<b>82033</b>
30-13 161 0001	<b>82051</b>
513 050 0003	<b>82056</b>
713 220 0005	<b>81804</b>

**NIPPARTS**

J1510315	<b>84058</b>
J1510501	<b>82020</b>
J1510520	<b>82021</b>
J1510529	<b>84015</b>
J1511032	<b>82054</b>
J1511065	<b>82053</b>
J1512069	<b>82051</b>
J1512086	<b>82048</b>
J1512092	<b>82022</b>
J1512108	<b>82044</b>
J1513036	<b>82092</b>
J1513060	<b>84060</b>
J1514039	<b>82039</b>
J1514042	<b>82045</b>
J1515065	<b>82049</b>
J1518010	<b>82050</b>
Y1510306	<b>82038</b>

**OPEN PARTS**

WAP8321.00	<b>82056</b>
WAP8458.00	<b>84007</b>

**OPTIBELT**

AQ-2278	<b>84008</b>
---------	--------------

**OPTIMAL**

AQ-1197	<b>81804</b>
AQ1214	<b>82018</b>
AQ-1419	<b>82054</b>
AQ-1427	<b>82053</b>
AQ-1769	<b>82051</b>
AQ1809	<b>82024</b>

**IAM**

**OPTIMAL**

AQ1814	<b>82030</b>
AQ1815	<b>82047</b>
AQ-1846	<b>82048</b>
AQ-2209	<b>84000</b>

**PEX**

19.0332	<b>82053</b>
---------	--------------

**QUINTON HAZELL**

3549	<b>82057</b>
QCP1018	<b>81434</b>
QCP1019	<b>81671</b>
QCP1292	<b>81664</b>
QCP1294	<b>81593</b>
QCP1350	<b>81549</b>
QCP1425	<b>11707</b>
QCP1431	<b>81443</b>
QCP1434	<b>81460</b>
QCP1435	<b>81506</b>
QCP1535	<b>82054</b>
QCP2062	<b>81544</b>
QCP2111	<b>81415</b>
QCP2273	<b>82040</b>
QCP2338	<b>81822</b>
QCP2346	<b>81554</b>
QCP2358	<b>81584</b>
QCP2364	<b>11706T</b>
QCP2369	<b>11701T</b>
QCP2369	<b>11701T</b>
QCP2433	<b>81784</b>
QCP2449	<b>81492</b>
QCP2450	<b>81504</b>
QCP2470	<b>81574</b>
QCP2471	<b>81543</b>
QCP2474	<b>81576</b>
QCP2477	<b>81618</b>
QCP2483	<b>81521</b>
QCP2483BH	<b>82001</b>
QCP2492	<b>81797</b>
QCP2492	<b>81556</b>
QCP2499	<b>81608</b>
QCP2512	<b>81606</b>
QCP2513	<b>81681</b>
QCP2517	<b>81605</b>
QCP2525	<b>81602</b>

**IAM**

**QUINTON HAZELL**

QCP2526	<b>81532</b>
QCP2527	<b>81538</b>
QCP2545	<b>81536</b>
QCP2558	<b>81491</b>
QCP2563	<b>81507</b>
QCP2565	<b>81559</b>
QCP2569	<b>81450</b>
QCP2570BH	<b>81456</b>
QCP2570BH	<b>81344</b>
QCP2572	<b>81458</b>
QCP2587	<b>81498</b>
QCP2591	<b>81619</b>
QCP2615	<b>81436</b>
QCP2645	<b>81683</b>
QCP2646	<b>81616</b>
QCP2647	<b>81617</b>
QCP2652	<b>81650</b>
QCP2660	<b>81661</b>
QCP2661	<b>81574</b>
QCP2664	<b>81833</b>
QCP2671	<b>81587</b>
QCP2674	<b>81832</b>
QCP2682BH	<b>81463</b>
QCP2683	<b>81326</b>
QCP2683BH	<b>81464</b>
QCP2686	<b>81684</b>
QCP2688	<b>81660</b>
QCP2697BH	<b>81309</b>
QCP2705	<b>81611</b>
QCP2735	<b>81588</b>
QCP2743	<b>81614</b>
QCP2743	<b>81615</b>
QCP2746	<b>81685</b>
QCP2801	<b>81828</b>
QCP2804	<b>81589</b>
QCP2873	<b>81353</b>
QCP2881	<b>81736</b>
QCP2882	<b>81744</b>
QCP2884	<b>81672</b>
QCP2887	<b>81654</b>
QCP2888	<b>81302</b>
QCP2889	<b>81655</b>
QCP2891	<b>81512</b>
QCP2894	<b>81653</b>
QCP2899	<b>81490</b>

IAM	MAGNETI MARELLI
<b>QUINTON HAZELL</b>	
QCP2904	11708T
QCP2925	81772
QCP2925	81807
QCP2928	81594
QCP2932	81488
QCP2933	81489
QCP2934	81654
QCP2941	81554
QCP2944	81642
QCP2950	81789
QCP2960	81743
QCP2961	19532/E
QCP2962	81854
QCP2971	81508
QCP2978	81770
QCP2985	81315
QCP2986	81300
QCP2987	81324
QCP2989	81509
QCP2990	82004
QCP2997	81573
QCP2997BH	81811
QCP3000	81314
QCP3000BH	81476
QCP3036	81790
QCP3037	81858
QCP3041	81770
QCP3058	81551
QCP3059	81550
QCP3060	81613
QCP3067	81590
QCP3070	81367
QCP3074	81333
QCP3084	81817
QCP3084	82005
QCP3090	82056
QCP3090	82056
QCP3092	81322
QCP3093	81700
QCP3096	81597
QCP3097	81742
QCP3098	81714
QCP3100	81656
QCP3102	81325
QCP3105	81499

IAM	MAGNETI MARELLI
<b>QUINTON HAZELL</b>	
QCP3106	81754
QCP3110	81334
QCP3111	81332
QCP3113	81365
QCP3113BH	81304
QCP3114	81339
QCP3114BH	81303
QCP3116	81717
QCP3119	81722
QCP3124	81667
QCP3125	81707
QCP3126	81708
QCP3127BH	81497
QCP3133	81766
QCP3135	81687
QCP3137	81759
QCP3138	81758
QCP3139	81757
QCP3140	81596
QCP3155	81773
QCP3156	81528
QCP3157	81527
QCP3165	81513
QCP3168	81746
QCP3170	81723
QCP3172	81724
QCP3173	81724
QCP3177	81745
QCP3179	81756
QCP3179BH	81853
QCP3182	81731
QCP3186	81666
QCP3192	81715
QCP3195	81525
QCP3201	81851
QCP3202	81755
QCP3208	81364
QCP3208BH	81341
QCP3209	81316
QCP3211	81331
QCP3212	81526
QCP3212BH	81529
QCP3213	81842
QCP3218	81340
QCP3219	81329

IAM	MAGNETI MARELLI
<b>QUINTON HAZELL</b>	
QCP3224	81598
QCP3226	81760
QCP3227	81579
QCP3228	81578
QCP3229	81857
QCP3231	81838
QCP3235	81839
QCP3243	81651
QCP3244	81771
QCP3255	81846
QCP3257	81709
QCP3262	81769
QCP3274	81657
QCP3289	81368
QCP3289BH	81346
QCP3290	82011
QCP3290	81749
QCP3292	81750
QCP3293	81748
QCP3298	81702
QCP3299	81762
QCP3300	81835
QCP3301	81764
QCP3302	81768
QCP3304	81777
QCP3305BH	81852
QCP3306	81703
QCP3313	81716
QCP3315	81369
QCP3316	81348
QCP3318	81301
QCP3319	81774
QCP3322	81710
QCP3323	81711
QCP3326	81776
QCP3327	81753
QCP3336	81785
QCP3345	81782
QCP3346	81780
QCP3348	82053
QCP3359	82051
QCP3360	81783
QCP3361	81837
QCP3362	81787
QCP3363	81362

IAM	MAGNETI MARELLI
<b>QUINTON HAZELL</b>	
QCP3364	81351
QCP3365	81775
QCP3366	81352
QCP3367	81366
QCP3367BH	81343
QCP3368	81733
QCP3369	81856
QCP3371	81355
QCP3372	81705
QCP3373	81793
QCP3373	81794
QCP3375	81844
QCP3376	81712
QCP3377	81320
QCP3378	81318
QCP3379	81319
QCP3380	82087
QCP3381	81730
QCP3382	82088
QCP3383	81726
QCP3384	81728
QCP3385	81729
QCP3386	81751
QCP3387	81747
QCP3389	84039
QCP3389	81806
QCP3390	81761
QCP3391	81713
QCP3394	81703
QCP3397	81725
QCP3398	81586
QCP3399BH	81469
QCP3401	81786
QCP3403	81477
QCP3404	81524
QCP3405	81363
QCP3405BH	81347
QCP3407	81372
QCP3407BH	81342
QCP3408	81803
QCP3409	81845
QCP3410	81802
QCP3422	81370
QCP3429	81815
QCP3430	82048

IAM	MAGNETI MARELLI
<b>QUINTON HAZELL</b>	
QCP3431	81809
QCP3435	81369
QCP3436	81801
QCP3437	81808
QCP3439	81767
QCP3442	81706
QCP3448	82050
QCP3452	82012
QCP3454	81781
QCP3458	81816
QCP3458	84011
QCP3476	84010
QCP3476	81791
QCP3477	82081
QCP3478	81840
QCP3479	81842
QCP3480	81779
QCP3482	84052
QCP3483	81836
QCP3483	81847
QCP3492	81799
QCP3493	82086
QCP3494	81800
QCP3495	81701
QCP3501	82021
QCP3503	82038
QCP3504	81796
QCP3505	81795
QCP3520	81855
QCP3527	82055
QCP3529	82039
QCP3539	81804
QCP3540	81812
QCP3541	81813
QCP3542	81805
QCP3561	82034
QCP3567	82013
QCP3595	82045
QCP3596	82041
QCP3606	82042
QCP3617	82047
QCP3629	84007
QCP3680	84000
QCP3681	84014
QCP3686	84015

IAM	MAGNETI MARELLI
<b>QUINTON HAZELL</b>	
QCP3709P	81419
QCP3710	81419
QCP3752	84035
QCP3790	84033
QCP3792	84008
QCP4163	81752
QCP4220	81330
QCP4453	81522
QCP4453BH	82080
QCP4453BH	82080
QCP766	81481
QCP958	81572
QCP969	81592
QCP972	81999
QCP977	81560
QCP985	81531
QCP986	81520
<b>RUVILLE</b>	
65023	82034
65109	82030
65129	82047
65214	81804
65216	82018
65434	84001
65434	84001
66816	82053
66940	82048
67403	82039
67702	82050
68900	82038
<b>Saleri SIL</b>	
PA1001	81712
PA1002	81701
PA1048	81798
PA1048	82040
PA1049	84010
PA1049	81791
PA1051	82081
PA1053	82029
PA1054	81713
PA1055	81799
PA1057	81834
PA1059	81837

IAM	MAGNETI MARELLI
<b>Saleri SIL</b>	
PA1060	81840
PA1069	81842
PA1071	81794
PA1072	81796
PA1072	81795
PA1073	81783
PA1075	81838
PA1078	81785
PA1087	82084
PA1095	82053
PA1102	84052
PA1116	81302
PA1121	81861
PA1126	81362
PA1128	81835
PA1129	84012
PA1130	81820
PA1131	81810
PA1132	81814
PA1133	82056
PA1133	82056
PA1134	81836
PA1135	81805
PA1138	81804
PA1160	81808
PA1161	81809
PA1162	82048
PA121	81419
PA1216	81817
PA1217	81818
PA1224	81855
PA1230	82033
PA1232	81866
PA1233	81867
PA1234	81797
PA1235	81800
PA1236	81813
PA1237	81862
PA1242	82051
PA1244	82030
PA1246	81872
PA1248	82040
PA1249	82040
PA1251	81812
PA1252	81869

IAM	MAGNETI MARELLI
<b>Saleri SIL</b>	
PA1253	82018
PA1254	82057
PA1255	84004
PA1259	82083
PA1260	82024
PA1264	82082
PA1267	82042
PA1268	82041
PA1269	82011
PA1271	81865
PA1272	81821
PA1273	82046
PA1274	81868
PA1278	82052
PA1282	81864
PA1284	82047
PA1285	84013
PA1290	82015
PA1293	81816
PA1293	84011
PA1294	82034
PA1295	82010
PA1302	81839
PA1303	82039
PA1304	82045
PA1305	81785
PA1306	82021
PA1312	82038
PA1321	82055
PA1322	81771
PA1328	82092
PA1329	82014
PA1330	82023
PA1331	82028
PA1347	82026
PA1348	82022
PA1349	82020
PA1355A	82013
PA1360	81733
PA1371	82063
PA1371	82063
PA1373	82025
PA1385	82070
PA1394	82066
PA1395	84007

IAM	MAGNETI MARELLI
<b>Saleri SIL</b>	
PA1402	84057
PA1404	82090
PA1425	82032
PA1426	82068
PA1440	82044
PA1454	84059
PA1459	84018
PA1475	84017
PA1481	81872
PA1487	84000
PA1502	84033
PA1503	84035
PA1507	84021
PA1510	84030
PA1511	84008
PA1519	81819
PA1532	84037
PA1540	84043
PA1550	84040
PA1582	84034
PA201AC	81419
PA206P	81415
PA215	81532
PA224	81552
PA229P	81572
PA231	81999
PA232	81671
PA234P	81481
PA257	81592
PA259	81560
PA275E	81531
PA276	11706T
PA278P	81520
PA280	81660
PA288	81434
PA288S	81434
PA318	82050
PA355	81544
PA358P	81543
PA364	81828
PA373	81602
PA380P	81593
PA382	81586
PA386	81618
PA397	81664



IAM	MAGNETI MARELLI
<b>Saleri SIL</b>	
PA413	81576
PA421P	81573
PA429P	81554
PA430	81574
PA431	81584
PA437P	81549
PA445P	81822
PA453	11701T
PA453	11701T
PA455	81492
PA459	81536
PA460	81522
PA463P	11707
PA464P	81573
PA465	81504
PA467A	81801
PA468	81521
PA472	81443
PA473	81594
PA484P	81498
PA488P	81538
PA493	81506
PA495	81559
PA497	81608
PA497	81666
PA498	81602
PA507	81436
PA511P	81556
PA512P	81606
PA515P	81611
PA518P	81619
PA521	82080
PA521	82080
PA522	82001
PA524P	81605
PA525P	81458
PA527P	81681
PA534P	81476
PA547	81463
PA552P	81464
PA557	81574
PA561	81509
PA562	81616
PA563	81754
PA564	19532/E

IAM	MAGNETI MARELLI
<b>Saleri SIL</b>	
PA570	81456
PA573	81832
PA576	81491
PA584	81367
PA589P	81525
PA590P	81651
PA591	81460
PA592	81450
PA594	81508
PA599	81650
PA607	81469
PA610	81507
PA611P	81661
PA616	81617
PA619P	81683
PA620P	81833
PA631	81477
PA633P	81672
PA636	81755
PA639P	81309
PA641	81851
PA645P	81756
PA645P	81853
PA646	81587
PA648P	81512
PA649P	81642
PA653	81654
PA655P	81524
PA656	81684
PA657	81685
PA658	81590
PA659	81588
PA660	81589
PA663P	81772
PA664P	81700
PA667	81653
PA669	81655
PA670P	81353
PA674P	82056
PA674P	81857
PA675	81687
PA681P	81613
PA682P	81614
PA683P	81615
PA684	81744

IAM	MAGNETI MARELLI
<b>Saleri SIL</b>	
PA685	81736
PA687	11708T
PA688	81490
PA690	81489
PA691P	81525
PA693P	81300
PA703P	81324
PA705	11706T
PA706	81315
PA707P	82005
PA708P	81550
PA709P	81551
PA710	81322
PA711P	81811
PA712	82004
PA713	81667
PA714	81597
PA715	81499
PA716	81722
PA717	81742
PA718	81724
PA719P	81333
PA720P	81513
PA721P	81854
PA722P	81852
PA723P	81314
PA724P	81656
PA731P	81303
PA732P	81339
PA733	81304
PA736P	81657
PA737P	81708
PA738P	81709
PA739P	81329
PA742P	81330
PA745	81325
PA748	81723
PA752	81759
PA753	81757
PA754	81758
PA757	81707
PA759P	81843
PA762A	81842
PA764	81365
PA766	81488

<b>IAM</b>	
------------	--

<b>Saleri SIL</b>	
PA775	81784
PA776	81787
PA782	81786
PA789	81789
PA797	81770
PA801	81858
PA802	81790
PA803	81714
PA816	81596
PA822	81815
PA824	81340
PA825	81341
PA826	81364
PA827	81342
PA828	81528
PA829	81529
PA830	81579
PA830	82056
PA831	81578
PA833	81316
PA834	81320
PA835	81724
PA838	81722
PA840	81526
PA843	81334
PA844	81332
PA846	81527
PA847	81773
PA848	81598
PA852	81340
PA852	81351
PA853	81344
PA854	81343
PA855	81366
PA856	81346
PA857	81368
PA858	81346
PA859	81368
PA860	81348
PA861	81331
PA864	81703
PA866	81702
PA867	81856
PA869	81752
PA870	81844

<b>IAM</b>	
------------	--

<b>Saleri SIL</b>	
PA871	81780
PA873	81301
PA874	81347
PA875	81363
PA877	81657
PA878	81845
PA879	81716
PA880	81760
PA881	81764
PA883	81705
PA884	81774
PA885	81711
PA886	81710
PA887	81846
PA890	81746
PA890	81750
PA890	81847
PA891	81747
PA894	81613
PA908	81708
PA913	81369
PA913	81369
PA914	81352
PA919	81318
PA920	81319
PA921	81743
PA923	81355
PA928	81782
PA931	82087
PA932	81725
PA934	81730
PA935	81749
PA936	81751
PA937	81748
PA938	81753
PA939	81762
PA941	81775
PA944	81706
PA945	81777
PA946	81776
PA948	81745
PA949	81802
PA950	81803
PA951	81726
PA952	82088

<b>IAM</b>	
------------	--

<b>Saleri SIL</b>	
PA953	81728
PA957	81781
PA958	81715
PA965	81793
PA967	81729
PA969	81761
PA970	84039
PA970	81806
PA974	81770
PA976	81769
PA980	81779
PA982	81807
PA983A	81370
PA984	82054
PA993	81731

<b>SASIC</b>	
3606034	84000
3606053	84014
4001198	82056

<b>ScanTech</b>	
55.1985	82056

<b>SKF</b>	
VKPA 84623	82057
VKPA81400	82001
VKPA81401	82080
VKPA81401	82080
VKPA81401	81529
VKPA82202	81300
VKPA82210	81456
VKPA82220	81458
VKPA82230	81303
VKPA82240	81342
VKPA82246	81366
VKPA82426	81450
VKPA82428	81469
VKPA82429	81463
VKPA82429	81347
VKPA82431	81476
VKPA82435	81497
VKPA82441	81341
VKPA82441	81364
VKPA82618	81464



<b>SKF</b>	
VKPA82620	<b>81309</b>
VKPA82634	<b>81489</b>
VKPA82648	<b>81324</b>
VKPA82653	<b>81304</b>
VKPA82670	<b>81320</b>
VKPA82671	<b>81319</b>
VKPA86206	<b>81811</b>
VKPA86212	<b>81854</b>
VKPA86217	<b>81852</b>
VKPA87607	<b>81843</b>
VKPA91441	<b>81768</b>
VKPC 84622	<b>81804</b>
VKPC 86811	<b>82069</b>
VKPC 88636	<b>82034</b>
VKPC 91807	<b>82048</b>
VKPC 91848	<b>84031</b>
VKPC 91850	<b>84028</b>
VKPC 92600	<b>82054</b>
VKPC 92926	<b>82053</b>
VKPC 93603	<b>82045</b>
VKPC 95857	<b>82020</b>
VKPC 95872	<b>84015</b>
VKPC 96001	<b>82050</b>
VKPC81200	<b>81520</b>
VKPC81204	<b>81524</b>
VKPC81206	<b>81525</b>
VKPC81210	<b>81527</b>
VKPC81215	<b>81775</b>
VKPC81302	<b>82013</b>
VKPC81400	<b>81521</b>
VKPC81401	<b>81522</b>
VKPC81402	<b>81526</b>
VKPC81407	<b>81777</b>
VKPC81408	<b>81702</b>
VKPC81411	<b>81776</b>
VKPC81416	<b>84052</b>
VKPC81417	<b>84010</b>
VKPC81417	<b>81791</b>
VKPC81419	<b>81840</b>
VKPC81602	<b>81593</b>
VKPC81606	<b>81683</b>
VKPC81609	<b>81832</b>
VKPC81610	<b>81833</b>
VKPC81611	<b>81773</b>
VKPC81612	<b>81700</b>



<b>SKF</b>	
VKPC81615	<b>81528</b>
VKPC81620	<b>81703</b>
VKPC81623	<b>81706</b>
VKPC81624	<b>81774</b>
VKPC81625	<b>81705</b>
VKPC81626	<b>81816</b>
VKPC81626	<b>84011</b>
VKPC81802	<b>81842</b>
VKPC81803	<b>81772</b>
VKPC82201	<b>11706T</b>
VKPC82202	<b>81415</b>
VKPC82206	<b>81481</b>
VKPC82208	<b>81434</b>
VKPC82214	<b>81801</b>
VKPC82230	<b>81339</b>
VKPC82240	<b>81372</b>
VKPC82245	<b>81333</b>
VKPC82246	<b>81343</b>
VKPC82247	<b>81351</b>
VKPC82249	<b>81369</b>
VKPC82249	<b>81369</b>
VKPC82250	<b>81370</b>
VKPC82419	<b>81498</b>
VKPC82424	<b>81436</b>
VKPC82429	<b>81363</b>
VKPC82431	<b>81314</b>
VKPC82432	<b>81477</b>
VKPC82436	<b>11708T</b>
VKPC82437	<b>81340</b>
VKPC82451	<b>81348</b>
VKPC82600	<b>81492</b>
VKPC82614	<b>81443</b>
VKPC82618	<b>81326</b>
VKPC82621	<b>11701T</b>
VKPC82621	<b>11701T</b>
VKPC82622	<b>81460</b>
VKPC82629	<b>81490</b>
VKPC82631	<b>81491</b>
VKPC82633	<b>11707</b>
VKPC82637	<b>81302</b>
VKPC82638	<b>81325</b>
VKPC82643	<b>81488</b>
VKPC82645	<b>81331</b>
VKPC82646	<b>81329</b>
VKPC82647	<b>81315</b>



<b>SKF</b>	
VKPC82650	<b>81334</b>
VKPC82651	<b>81332</b>
VKPC82652	<b>81316</b>
VKPC82653	<b>81365</b>
VKPC82660	<b>81322</b>
VKPC82665	<b>81352</b>
VKPC82665	<b>81330</b>
VKPC82800	<b>19532/E</b>
VKPC83200	<b>81572</b>
VKPC83205	<b>81556</b>
VKPC83206	<b>81560</b>
VKPC83401	<b>81554</b>
VKPC83420	<b>81642</b>
VKPC83424	<b>81672</b>
VKPC83425	<b>81353</b>
VKPC83428	<b>81513</b>
VKPC83430	<b>81753</b>
VKPC83615	<b>81512</b>
VKPC83617	<b>81822</b>
VKPC83630	<b>81367</b>
VKPC83635	<b>81710</b>
VKPC83636	<b>81711</b>
VKPC83637	<b>81844</b>
VKPC83639	<b>81713</b>
VKPC83810	<b>81752</b>
VKPC83811	<b>81712</b>
VKPC84205	<b>81531</b>
VKPC84208	<b>81538</b>
VKPC84209	<b>81650</b>
VKPC84210	<b>81653</b>
VKPC84215	<b>81598</b>
VKPC84216	<b>81716</b>
VKPC84403	<b>81536</b>
VKPC84404	<b>81651</b>
VKPC84406	<b>81655</b>
VKPC84407	<b>82004</b>
VKPC84408	<b>81656</b>
VKPC84409	<b>81657</b>
VKPC84411	<b>81654</b>
VKPC84415	<b>81803</b>
VKPC84416	<b>81802</b>
VKPC84600	<b>81532</b>
VKPC84601	<b>81602</b>
VKPC84618	<b>81559</b>
VKPC85201	<b>81544</b>

**IAM**

<b>SKF</b>	
VKPC85202	<b>81543</b>
VKPC85206	<b>81549</b>
VKPC85211	<b>82005</b>
VKPC85220	<b>81749</b>
VKPC85401	<b>81681</b>
VKPC85403	<b>81684</b>
VKPC85404	<b>81685</b>
VKPC85404	<b>81687</b>
VKPC85407	<b>81606</b>
VKPC85408	<b>81605</b>
VKPC85607	<b>81551</b>
VKPC85611	<b>81550</b>
VKPC85613	<b>81846</b>
VKPC85620	<b>81746</b>
VKPC85621	<b>81748</b>
VKPC85622	<b>81750</b>
VKPC85623	<b>81747</b>
VKPC85624	<b>81751</b>
VKPC86205	<b>81660</b>
VKPC86206	<b>81573</b>
VKPC86206	<b>81596</b>
VKPC86209	<b>81756</b>
VKPC86209	<b>81853</b>
VKPC86215	<b>81762</b>
VKPC86216	<b>81578</b>
VKPC86405	<b>81828</b>
VKPC86408	<b>81754</b>
VKPC86409	<b>81661</b>
VKPC86413	<b>81574</b>
VKPC86415	<b>81579</b>
VKPC86416	<b>84039</b>
VKPC86416	<b>81806</b>
VKPC86418	<b>84007</b>
VKPC86601	<b>81664</b>
VKPC86601	<b>81851</b>
VKPC86602	<b>81576</b>
VKPC86603	<b>81608</b>
VKPC86603	<b>81666</b>
VKPC86604	<b>81755</b>
VKPC86606	<b>81759</b>
VKPC86609	<b>81594</b>
VKPC86610	<b>81592</b>
VKPC86615	<b>81757</b>
VKPC86616	<b>81758</b>
VKPC86618	<b>82056</b>

**IAM**

<b>SKF</b>	
VKPC86618	<b>81857</b>
VKPC86618	<b>82056</b>
VKPC86619	<b>81701</b>
VKPC86621	<b>81667</b>
VKPC86631	<b>81760</b>
VKPC86633	<b>81761</b>
VKPC87200	<b>81419</b>
VKPC87201	<b>81419</b>
VKPC87400	<b>81614</b>
VKPC87401	<b>81615</b>
VKPC87404	<b>81613</b>
VKPC87813	<b>81707</b>
VKPC87814	<b>81709</b>
VKPC88200	<b>81999</b>
VKPC88203	<b>81619</b>
VKPC88206	<b>82087</b>
VKPC88605	<b>81586</b>
VKPC88607	<b>81616</b>
VKPC88608	<b>81504</b>
VKPC88610	<b>81584</b>
VKPC88611	<b>81587</b>
VKPC88612	<b>81617</b>
VKPC88615	<b>81590</b>
VKPC88616	<b>81589</b>
VKPC88617	<b>81588</b>
VKPC88619	<b>81509</b>
VKPC88620	<b>81506</b>
VKPC88622	<b>81499</b>
VKPC88625	<b>81723</b>
VKPC88631	<b>81725</b>
VKPC88802	<b>81618</b>
VKPC88808	<b>81508</b>
VKPC88810	<b>81507</b>
VKPC88824	<b>81722</b>
VKPC88826	<b>81597</b>
VKPC88828	<b>81724</b>
VKPC88842	<b>81726</b>
VKPC88843	<b>82088</b>
VKPC88844	<b>81728</b>
VKPC88845	<b>81729</b>
VKPC88846	<b>81730</b>
VKPC88848	<b>84012</b>
VKPC90200	<b>81780</b>
VKPC90202	<b>81781</b>
VKPC90402	<b>81782</b>

**IAM**

<b>SKF</b>	
VKPC91416	<b>81815</b>
VKPC91441	<b>81769</b>
VKPC91814	<b>82022</b>
VKPC92208	<b>81742</b>
VKPC92209	<b>81743</b>
VKPC92408	<b>81744</b>
VKPC92412	<b>81736</b>
VKPC93205	<b>81611</b>
VKPC93210	<b>81838</b>
VKPC93415	<b>81839</b>
VKPC93601	<b>81708</b>
VKPC95424	<b>81786</b>
VKPC95426	<b>81731</b>
VKPC96210	<b>81858</b>
VKPC96212	<b>81789</b>
VKPC96402	<b>81790</b>
VKPC97200	<b>81714</b>
VKPC97201	<b>81715</b>

<b>SWAG</b>	
10150037	<b>82030</b>
10 92 63 93	<b>82052</b>
50 92 22 51	<b>81804</b>
55 15 0003	<b>82056</b>
90 92 6279	<b>82021</b>

<b>TRISCAN</b>	
860013034	<b>82022</b>
860018003	<b>82038</b>
860023044	<b>82030</b>
860040012	<b>82045</b>
8600 10030	<b>84014</b>
8600 13013	<b>82048</b>
8600 13018	<b>84032</b>
8600 13034	<b>82044</b>
8600 14010	<b>82053</b>
8600 14950	<b>82054</b>
8600 40115	<b>82039</b>
8600 69005	<b>82050</b>
8600-13028	<b>82051</b>

<b>VAICO</b>	
V10-50062	<b>82025</b>
V20-50039	<b>84000</b>
V25-50013	<b>81804</b>

IAM	MAGNETI MARELLI
<b>VALEO</b>	
506325	<b>82056</b>
506357	<b>82054</b>
506534	<b>82053</b>
506618	<b>82051</b>
506694	<b>81804</b>
506708	<b>82048</b>
506711	<b>82034</b>

IAM	MAGNETI MARELLI
<b>VALEO</b>	
506726	<b>82033</b>
506789	<b>82057</b>
506809	<b>82018</b>
506811	<b>82039</b>
506812	<b>82045</b>
506816	<b>82020</b>
506819	<b>82021</b>

IAM	MAGNETI MARELLI
<b>VALEO</b>	
506833	<b>82030</b>
506849	<b>82044</b>
506851	<b>82022</b>
506852	<b>82063</b>
506852	<b>82063</b>
506863	<b>84007</b>



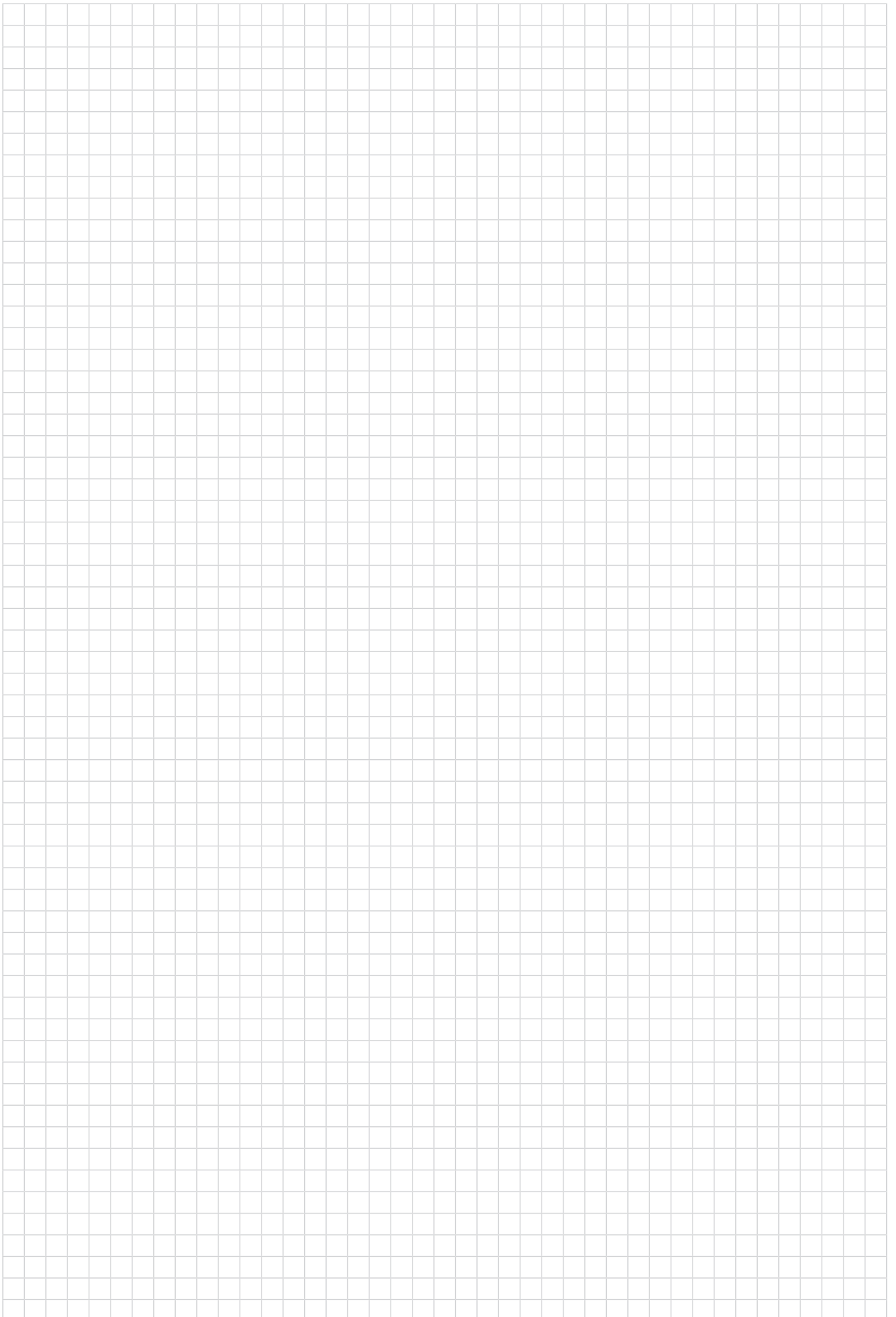

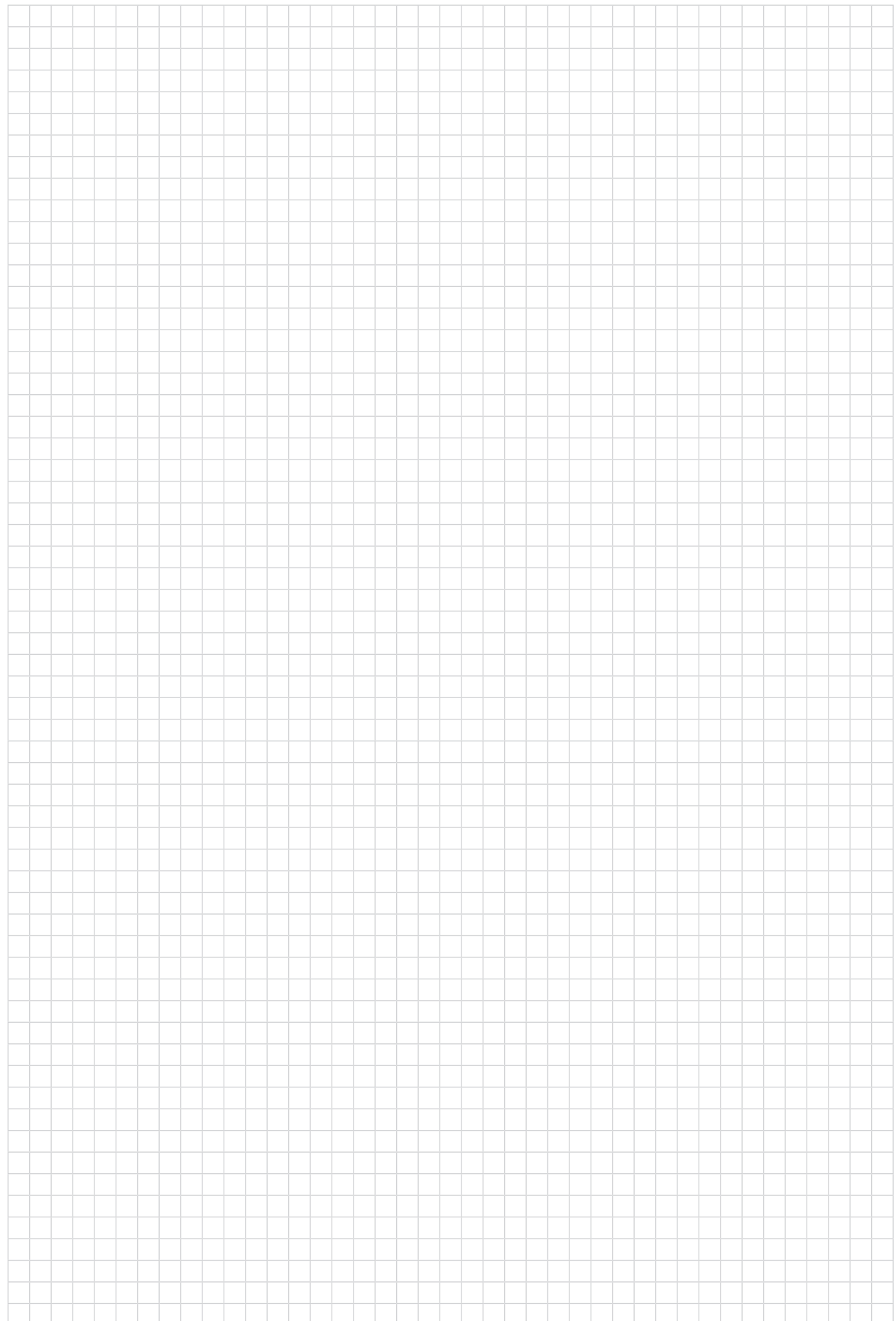









**ITALY**

Viale Aldo Borletti, 61/63  
20011 Corbetta (Milano)  
Tel. +39 02 928 15 111 • Fax +39 02 97227234

**Export**

Viale Aldo Borletti, 61/63  
20011 Corbetta (Milano) Italy  
Tel. +39/02/97227618 • Fax +39/02/97227755

**SPAIN**

Polígono Industrial G-2 Collsabadell  
Ronda de Collsabadell, 1-3  
08450, Llinars del Vallès, BCN  
Tel. +34/93/8413530 • Fax +34/93/8427257

**FRANCE**

Z.A. Trappes Elancourt  
5-7 rue Albert Einstein - 78190 Trappes  
tel +33 (0)1 3016 6960 • Fax +33 (0)1 3016 6961

**GERMANY**

Salzstrasse 185/1  
74076 Heilbronn  
Tel. +49/7131/2910 • Fax +49/7131/165236

**POLAND and RUSSIA**

Plac pod Lipami 5  
40-476 Katowice  
Tel. +48/32/6036107 • Fax +48/32/6036108

**BRAZIL**

Rua Manoel da Nóbrega, 350  
09380-120 Mauá-São Paulo  
Tel. +55/11/2144-1717 • Fax +55/11/2144-1688

**ARGENTINA**

R. Andonaegui 1035  
(C1427BEC) Capital Federal-Buenos Aires  
Tel. +54/11/45236612 • Fax +54/11/45236613

**CHINA**

Building No 5, 88 Maji Road, Waigaoqiao Free Trade Zone,  
200131 Pudong Shanghai  
Tel. +86/21/58696966-6852 • Fax +86/21/58696907

**TURKEY**

Büyükdere Cad. Tofaş Han No.145  
Zincirlikuyu, 34394 Istanbul-Turkey  
Ph: +90 212 217 02 97 • Fax: +90 212 217 02 95

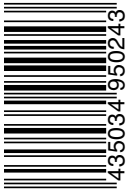

8 435034 950243

02-17 099995361702 Copyright Magneti Marelli After Market Parts and Services S.p.A. 2017

